

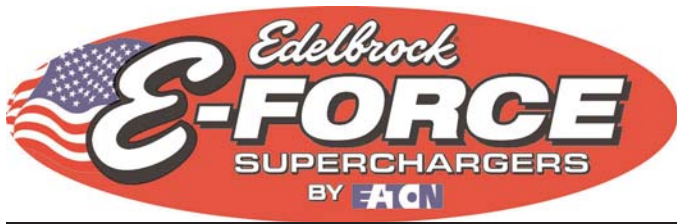

Edelbrock E-Force Supercharger
2010 Ford Mustang GT 4.6L
Part #1582 & 1587



Edelbrock 4.6L Ford Supercharger System for 2010 and later Mustang GTs

Installation Instructions

INTRODUCTION

Thank you for purchasing the Edelbrock 4.6L Ford Supercharger System for the Mustang GT. The Edelbrock E-Force Supercharger System for the 2010 4.6L 3V Mustang utilizes Eaton's new Gen VI TVS Supercharger rotors, featuring a four lobe design with a full 160° of twist for maximum flow, minimum temperature rise, quiet operation, and the reliability for which Eaton is known. These rotors however, are merely the foundation of the system. The Edelbrock Supercharger is a complete system that maximizes efficiency and performance by minimizing air restriction into, and out of, the supercharger. This results in maximum airflow, with minimum temperature rise and minimum power consumption. In addition, Edelbrock inverted the supercharger and packaged it down low in the valley, allowing for an incredible, industry leading, 15 inches of runner length, maximizing low end torque. The supercharger housing itself is integrated into the intake manifold for a seamless design with minimal components, eliminating the possibility of vacuum leaks between gasket surfaces. The system also utilizes a front drive, front inlet configuration giving it the shortest, least restrictive inlet path on the market. Further minimizing inlet restriction is the massive 85mm electronic throttle body that is included in the kit. Sitting right above the supercharger and below the enormous runners is the largest air to water intercooler available, measuring an astonishing 110 square inches. Last but not least, the E-Force supercharger is without a doubt the best looking engine compartment upgrade imaginable. It features a uniquely styled plenum, and includes matching side covers. In summation, the Edelbrock supercharger will provide you with the most power at the lowest amount of boost resulting in neck snapping performance that is safe to operate on a completely stock engine. It is also pending 50 state emissions legality, and can be had with an optional 5 yr 60,000 mile warranty so that there are no worries when installing it on your brand new car.

TOOLS REQUIRED

- Jack and Jack Stands
OR Service Lift
- Panel Puller
- Ratchet and Socket Set including
5.5mm (or 7/32"), 7mm, 8mm,
10mm, 12mm (deep), 13mm, 15mm
& a 9/16" Spark Plug Socket
- 12" Ratchet Extension Bar
- 1/2" Breaker Bar
- Flat Blade & Philips Screwdrivers
- Torx-20 Driver
- 1/8" Allen Wrench
- 5/8" Fuel Line Removal Tool
- 1" Stepped Drill Bit
- 17mm Allen Socket
- Torque Wrench
- Needle Nose Pliers
- Pliers
OR Hose Clamp Removal Tool
- Hacksaw, Drill & File
OR Grinding & Cut-Off Wheels
- Impact Wrench
- Vice
- Wire Stripper
- Wire Crimper
- Terminal Removal & De-Pinning Tools
OR Safety Pin
- Heat Gun
- Blue Loctite
- O-ring Lube
- Masking Tape

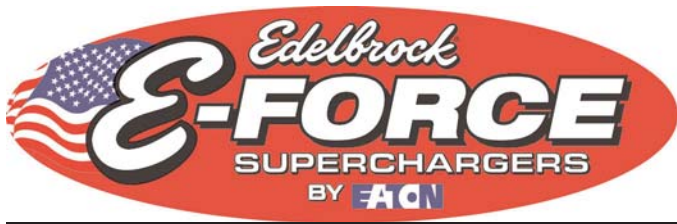

Edelbrock 4.6L Ford Supercharger System for 2010 and later Mustang GTs

Installation Instructions

IMPORTANT WARNINGS

Before beginning installation, use the enclosed checklist to verify that all components are present in the box then inspect each component for damage that may have occurred in transit. If any parts are missing or damaged, contact Edelbrock Technical Support, not your parts distributor.



WARNING: Installation of this supercharger will result in a significant change to the performance characteristics of your vehicle. It is highly recommended that you take some time to familiarize yourself with the added power, and how it is delivered, in a controlled environment. Take extra care on wet and slippery roads, as the rear tires will be more likely to lose traction, with the added power. It is never recommended to turn off your vehicles traction control system.

Proper installation is the responsibility of the installer. Improper installation will void all manufacture's standard warranties and may result in poor performance and engine or vehicle damage.

Due to the complexity of the Edelbrock E-Force Supercharging system, it is recommended that this system only be installed by a qualified professional with access to a service lift, pneumatic tools, and a strong familiarity with automotive service procedures. To qualify for the optional supplemental warranty, it is necessary to have this system installed by a Certified ASE Technician, GM Dealership, or an Authorized Edelbrock Installer. Failure to do so will void and/or disqualify any and all optional supplemental warranties offered with this system. Please contact the Edelbrock Technical Support department if you have any questions regarding this system and/or how your installer of choice will affect any warranty coverage for which your vehicle may qualify.

Any previously installed aftermarket tuning equipment must be removed and the vehicle returned to an as stock condition before installing the supercharger.

Any equipment that directly modifies the fuel mixture or ignition timing of the engine can cause severe engine damage if used in conjunction with the Edelbrock E-Force Supercharger System. This includes, but is not limited to: ignition boxes, air/fuel controllers, OBDII programmers, and any other device that modifies signals to and/or from the ECU. Aftermarket bolt-on equipment such as underdrive pulleys or air intake kits will also conflict with the operation of the supercharger and must be removed prior to installation. Use of any of these products with the E-Force Supercharger could result in severe engine damage.

Do not use a wideband oxygen sensor in place of the rear O2 sensor when dyno testing this supercharger system. The voltage signal will cause the fuel system to run lean and possible engine damage.

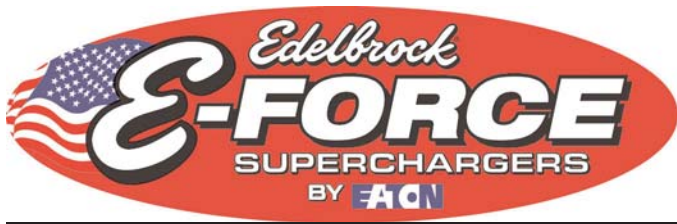

Edelbrock 4.6L Ford Supercharger System for 2010 and later Mustang GTs

Installation Instructions

IMPORTANT WARNINGS (CONTINUE)



91 octane or higher gasoline is required at all times. If your vehicle has been filled with anything less, it must be run until dry and refilled with 91 or higher octane gasoline twice prior to installation.

Failure to use the required 91 octane gasoline or higher could permanently damage your engine. Any failures associated with not using premium 91 octane gasoline or higher, will be ineligible for warranty repairs.

Edelbrock periodically releases improved versions of the calibration file found on the supplied handheld programmer. Check the website to ensure you have the latest version, as described in step #147.

INSTALLING A BOOST GAUGE OR PRESSURE TRANSDUCER

The only one option is to utilize the pressure port at the rear of the passenger side intake runner flange. Your supercharger has been pre-drilled and tapped for a 1/8" NPT fitting. There is currently a plug sealing the hole, which can be removed, and replaced with a fitting to adapt to your sensor.

CAUTION: Never cut into the vacuum lines leading to the fuel rail pressure sensor and bypass actuator, on the driver's side of the manifold, for the purpose of tapping in a boost gauge. Interruption of the vacuum signal to the fuel rail pressure sensor can affect the fuel pressure reading to the PCM, which can result in engine failure!

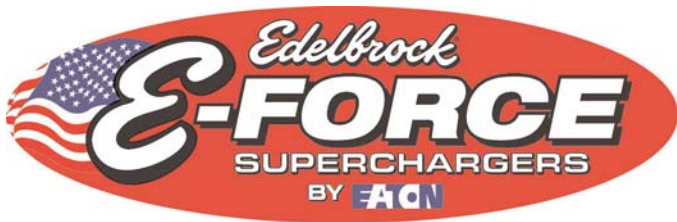

Edelbrock 4.6L Ford Supercharger System for 2010 and later Mustang GTs

Installation Instructions

INSTALLATION HARDWARE PARTS LIST

Hardware Bag #1



Hardware Bag #2



Hardware Bag #3

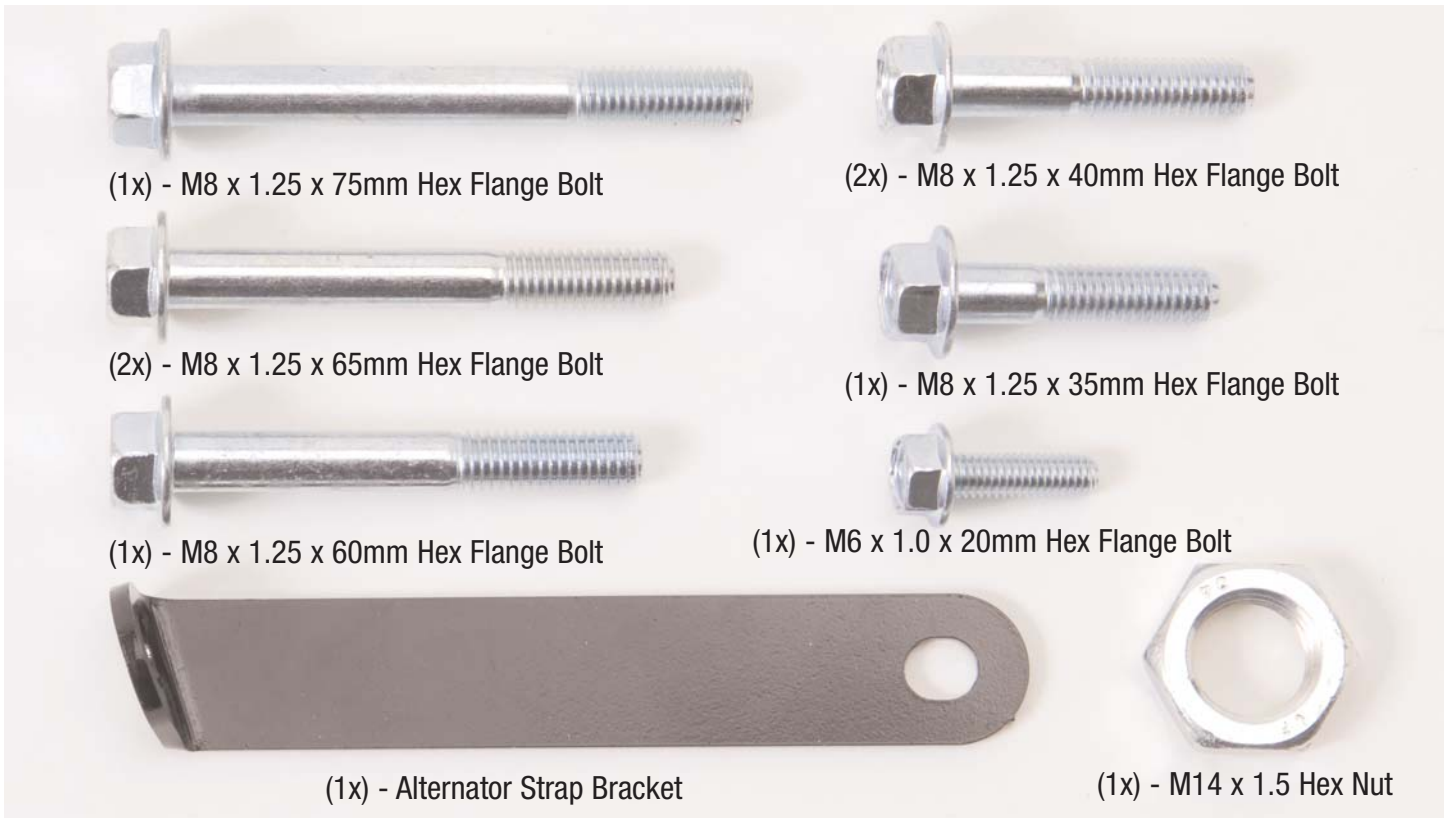

Hardware Bag #4



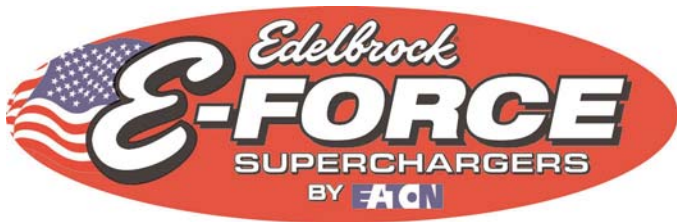

Edelbrock 4.6L Ford Supercharger System for 2010 and later Mustang GTs

Installation Instructions

INSTALLATION HARDWARE PARTS LIST (Continued)

Hardware Bag #5

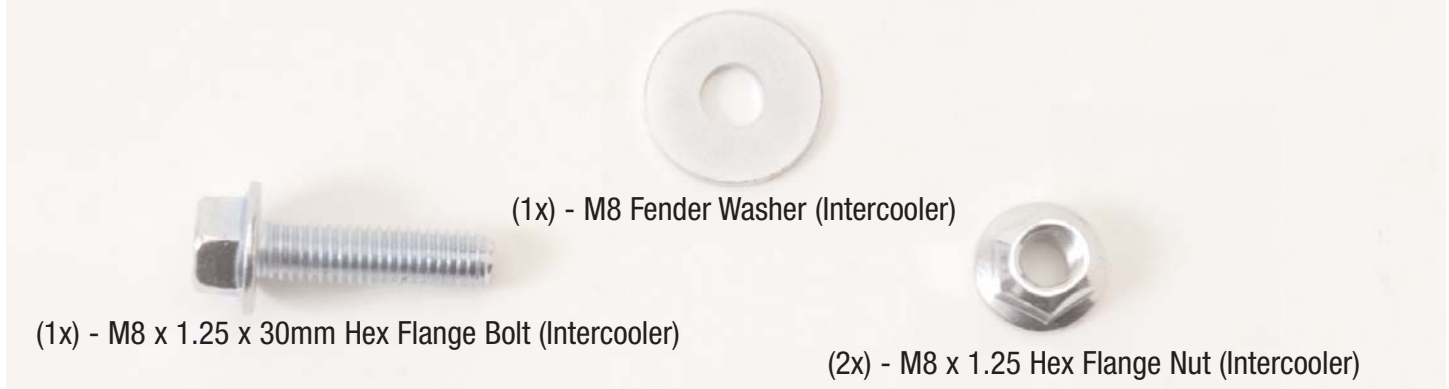

Hardware Bag #6



Hardware Bag #7



Hardware Bag #8

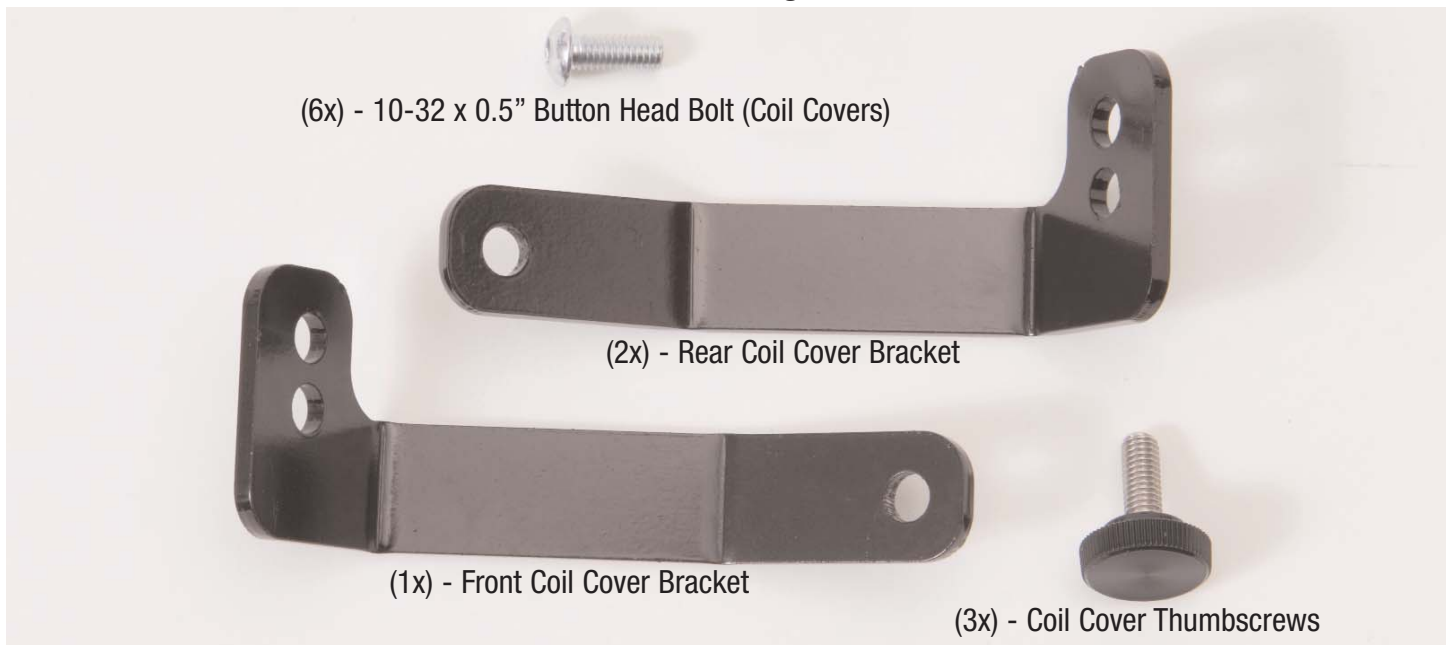

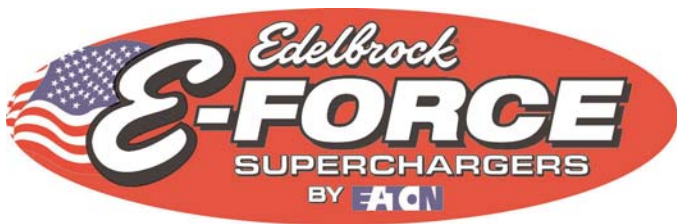

Edelbrock 4.6L Ford Supercharger System for 2010 and later Mustang GTs

Installation Instructions

I. Hood Removal

1. Use a panel puller to pry off the thirteen push-pins retaining the hood insulator and set the insulator aside. Remove the clips that retain each nozzle hose, then pull off the clips holding the washer hose to the hood.



Remove clamps to disconnect these hoses.

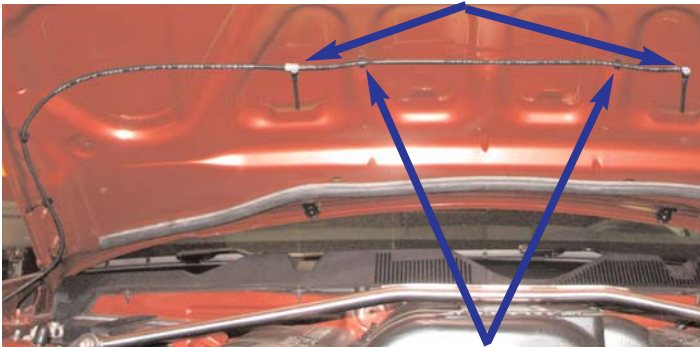

Use a panel puller to detach these clips.

2. Have an assistant support the hood while a 10mm socket is used to remove the four bolts attaching it to its hinges. Lift the hood off the vehicle and set it aside.



II. Battery Removal

3. Use an 8mm socket to loosen the negative battery terminal clamp and remove it. Tuck it to the side to prevent any accidental contact with the negative battery terminal.

4. Use a 10mm socket to remove the nut on the positive battery terminal that retains the alternator power wire. Detach this wire from the terminal, then loosely reinstall the nut.



5. Use an 8mm socket to loosen and remove the positive battery terminal clamp, then tuck the wire over to the side.

6. Use an 8mm socket to loosen the long bolt that secures the battery tie-down strap, then pull the insulating sleeve off of the battery. Remove the battery and set it aside.

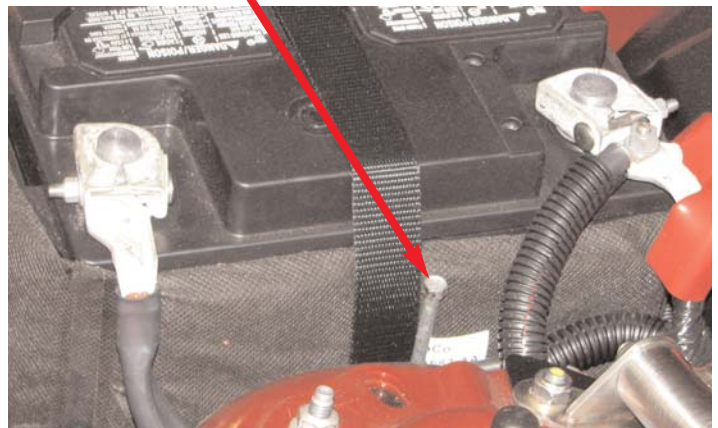

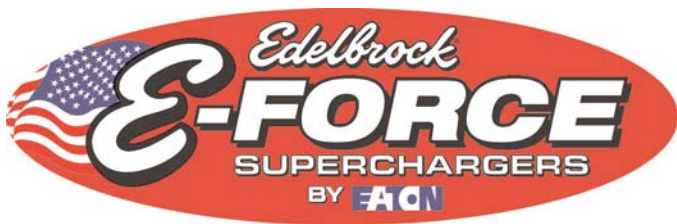

Edelbrock 4.6L Ford Supercharger System for 2010 and later Mustang GTs

Installation Instructions

7. Use an 8mm socket with a 12" extension bar to remove the three bolts holding the battery tray in place, then use a panel puller to detach the wiring harness clip. Remove and set aside the tray.



Bolts

Wiring Harness Clip

8. Use a flat blade screwdriver to pry up the head of the eight push-pins that retain the radiator shroud, then use a panel puller to fully remove the push-pins. Lift the shroud off the car and set it and the push-pins aside.

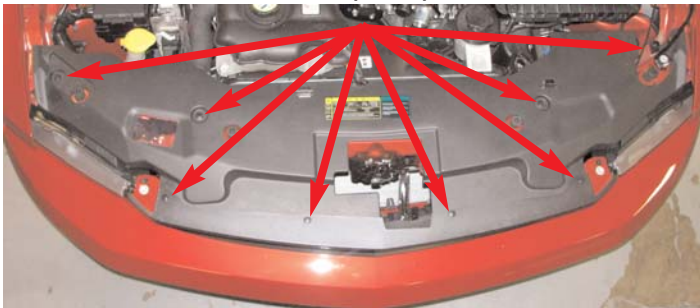

9. Use a turkey baster or siphon hose to drain the power steering reservoir. Loosen the hose clamps at the base of the reservoir. Using a shop rag to absorb any excess power steering fluid, pull the hoses off and tuck them to one side. Unbolt and remove the reservoir. The reservoir itself can be discarded, but save the stock bolt for reuse later.

III. Removing Engine Components

10. Detach the charge motion control valve (CMCV) electrical connector at the rear of the manifold. Separate the wiring retainers from the intake manifold stud and the CMCV bracket, then move the wiring harness to the side.



11. Detach the throttle position sensor (TPS) and electronic throttle control (ETC) connectors from the throttle body.



ETC

TPS

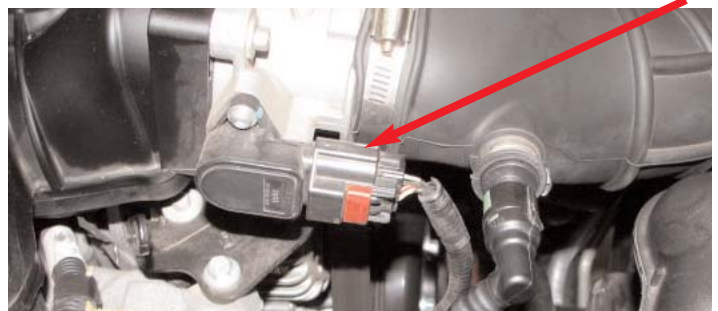

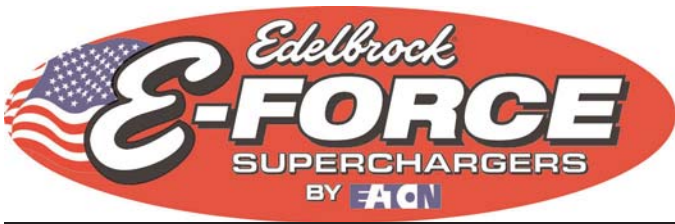

Edelbrock 4.6L Ford Supercharger System for 2010 and later Mustang GTs

Installation Instructions

12. Detach the mass airflow sensor electrical connector from the air filter outlet tube.

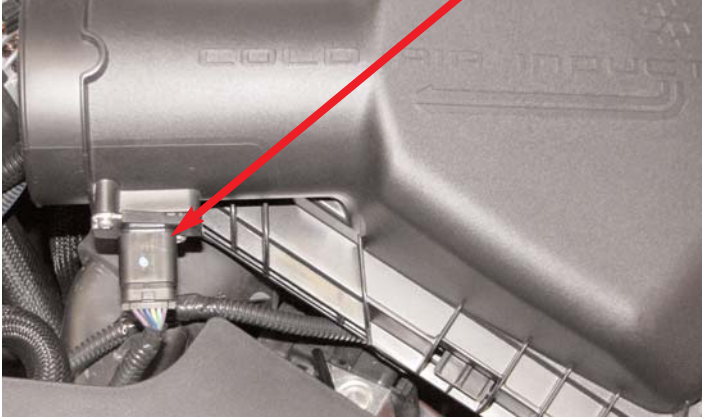

13. Disconnect the evaporative emissions tube from the intake manifold and move it to the side.



14. Disconnect the PCV line from where it is connected to the driver side valve cover, then disconnect it from the intake manifold and remove it. This hose will not be reused.



15. Disconnect and remove the passenger side PCV hose. This hose will not be reused.



16. Detach the electrical connectors from all eight fuel injectors and the fuel pressure sensor.

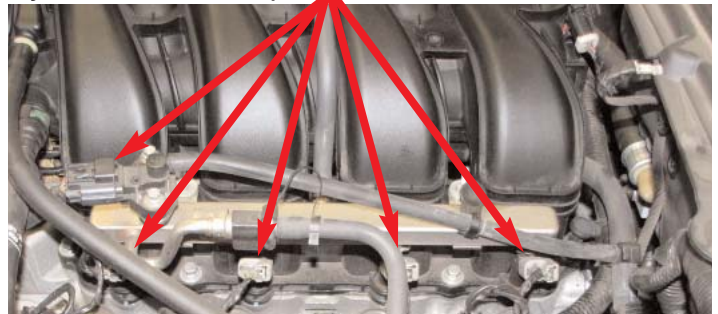

17. Disconnect the vacuum hose from the fuel pressure sensor.



18. Detach the battery cable anchors from the fuel rail bolts by pulling upward firmly.

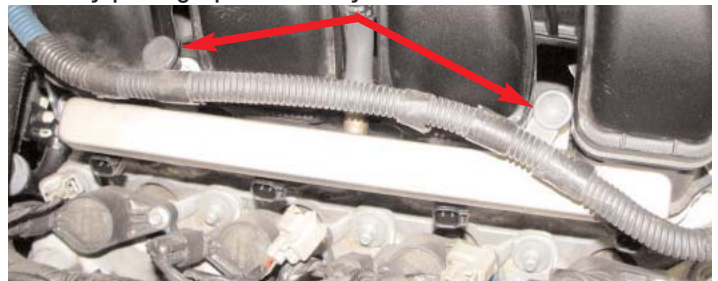

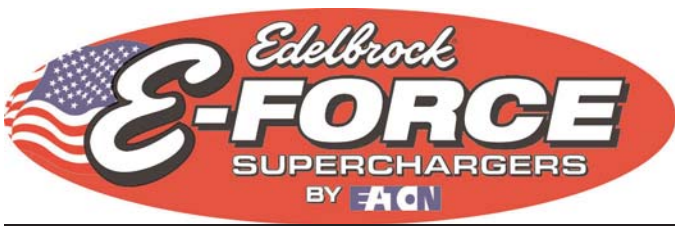

Edelbrock 4.6L Ford Supercharger System for 2010 and later Mustang GTs

Installation Instructions

19. Remove the fuel line lock clip and let it dangle.



20. Use a 5/8" fuel line removal tool to disconnect the fuel supply line from the fuel rails. Use a shop rag wrapped over the connection to absorb the fuel remaining in the system.



21. Disconnect the vacuum hose connected to the brake booster.



Pull hose off nipple, do not remove fitting from booster.

22. Loosen the four studs that hold down the fuel rails. The rails and injectors can then be removed together and set aside.



23. Remove the retaining clips that hold in the injectors and set them aside for reinstallation later, along with the rails. The stock injectors will not be reused.

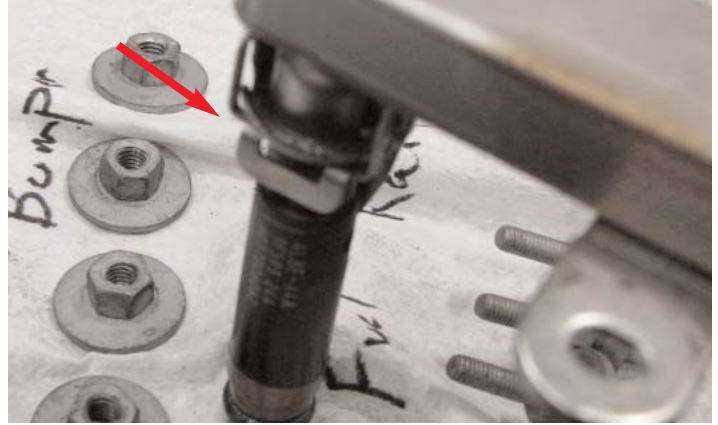

24. Use a flat head screwdriver to loosen the worm clamps that retain the air inlet tube between the throttle body and air filter cover, then remove the tube. Pull the attached induction roar resonator tube out of the firewall and discard it, it will not be reused.



25. The manifold bolts may now be removed with a 10mm socket and the intake lifted off the engine. There is no need to detach the throttle body as it will not be reused. Use an extension bar to reach the two center bolts hidden between the runners.

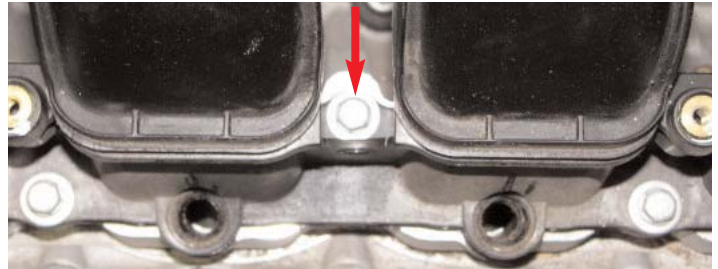

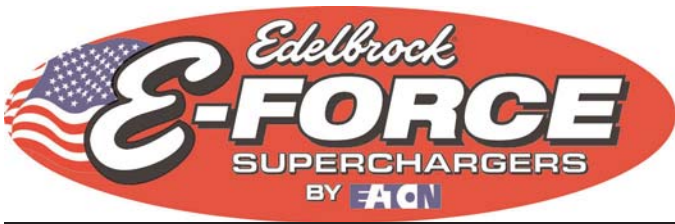

Edelbrock 4.6L Ford Supercharger System for 2010 and later Mustang GTs

Installation Instructions

26. Use a soft cloth to clean any irregularities on the sealing surfaces of the cylinder heads. Use two strips of masking tape to prevent any debris from entering the exposed ports.



27. Detach the MAF sensor harness from the rear of the air filter housing.



28. Unlatch the air cleaner cover and remove it.

29. Loosen the tensioner arm by using a 1/2" drive breaker bar, and remove the serpentine belt. This belt can be discarded as it will not be reused.



30. Use a 13mm socket to remove the two nuts at the bottom of the alternator.

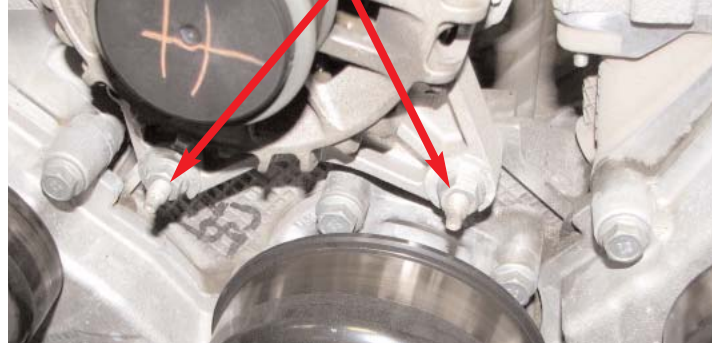

31. Use a 10mm socket to remove the two outer alternator bracket bolts, and an 8mm socket to remove the two inner alternator bracket bolts.



32. Use a panel puller to remove the harness locating pin from the alternator bracket, remove the bracket, then disconnect the alternator electrical connector. Trace the alternator harness back to where it clips into the main harness and detach it. This wire may now be discarded.

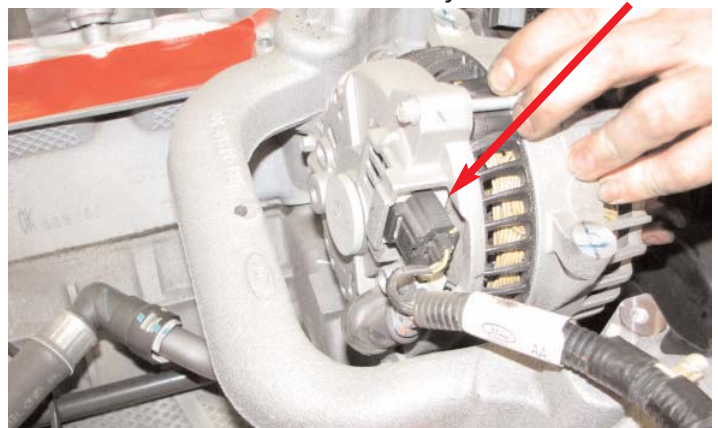



Edelbrock 4.6L Ford Supercharger System for 2010 and later Mustang GTs

Installation Instructions

33. Push aside the protective boot to access and remove the nut retaining the alternator power wire. The power wire will not be reused and can be discarded. The alternator can now be lifted out and set aside.



IV. Front Fascia

34. Use a 10mm socket to remove the two upper front bumper cover bolts, located between the grille and headlights.



35. Use a jack and jack stands or a service lift to raise the front of the vehicle. Use a 5.5mm (or 7/32") socket to remove the eleven bolts that retain the lower splash shield, then set the shield and bolts aside.

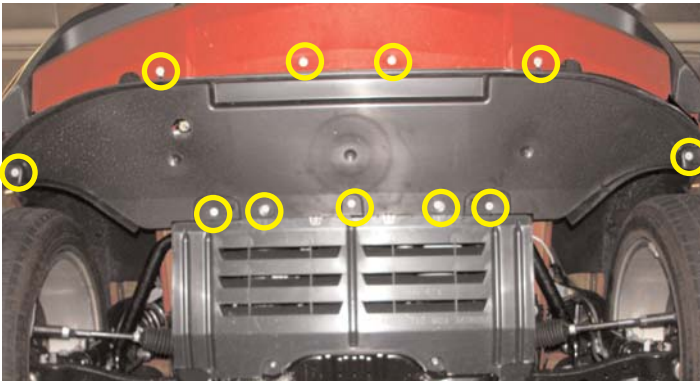

36. Pull the front bumper cover away from the fender and off the clips that hold it in place, then forward slightly to access the fog lamp, turn signal and running light electrical connectors. Once these have been detached, the entire front cover can be removed with the lights and indicators in place.



37. Use a panel puller to remove the four pins retaining the foam insulator, then set them and the insulator aside.



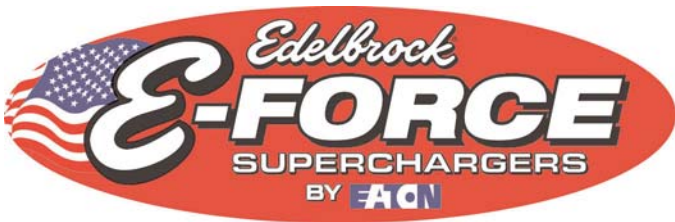

Edelbrock 4.6L Ford Supercharger System for 2010 and later Mustang GTs

Installation Instructions

V. Cooling System

38. To avoid injury be sure the engine has fully cooled before draining the cooling system. Release any excess pressure in the system by using a cloth to rotate the radiator cap counterclockwise. Step away from the vehicle if any hot vapor is vented, then remove the cap.



39. Place a drain pan below the radiator petcock on the passenger side, then use a 19mm wrench to open the petcock and drain the coolant.



40. Disconnect the upper radiator hose from the thermostat housing and radiator, then set it aside.

41. Remove and save the thermostat, its housing and the o-ring for later reuse.

42. Unbolt and remove the water crossover from the front of the engine block and unclip the heater hose from the bottom. Save the o-ring seals for later reuse.

VI. Installing Intercooler Accessories

43. Remove the plastic shrouds located on either side of the radiator by removing the plastic clips that hold them in with a panel puller



44. Replace the passenger side, upper inside bumper bolt with the M8 x 30mm long hex flange bolt and the M8 washer included in hardware bag #5.



45. Remove the four bolts that hold the AC condenser in place. Be careful as you remove the fourth screw as the condenser will be loose and only held in place by the AC hoses and surrounding components.

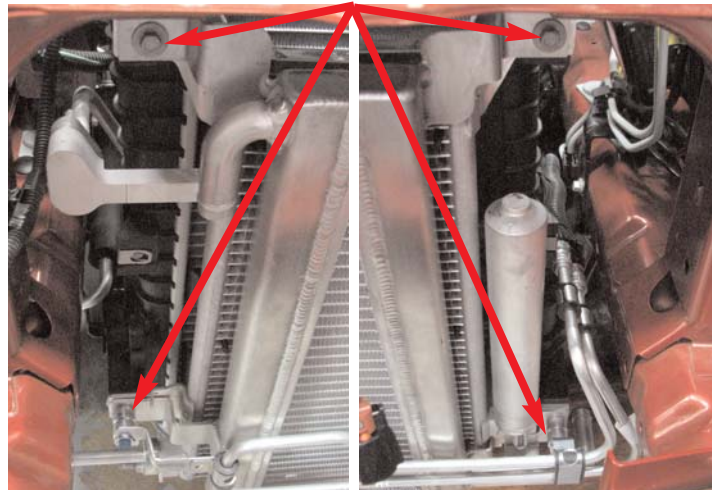

46. Insert the heat exchanger in front of the condenser so that the downward bent tube is on the passenger side, then raise the heat exchanger and condenser together so that the original top two bolts can be inserted through both brackets and hand tightened.

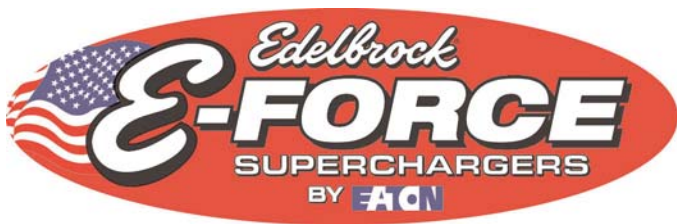

Edelbrock 4.6L Ford Supercharger System for 2010 and later Mustang GTs

Installation Instructions

47. Insert the spacers supplied in Hardware Bag #5 between the heat exchanger and power steering line brackets, then install the two M6 x 55mm bolts. Tighten all four bolts supporting heat exchanger and condenser.

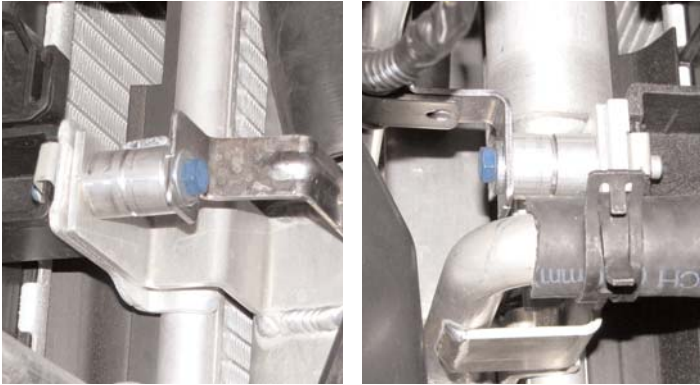

48. Fit the short molded hose onto the outlet of the water pump and secure it with a hose clamp.



49. Mount the water pump onto the water pump bracket by sliding the bent edge of the strap into the notch on the bracket and tightening the supplied bolt on the other end of the strap. Orient the pump so that the outlet will point up and back towards the intercooler inlet, while the water pump intake will point towards the passenger side fender.

50. Slide an extra clamp onto the outlet hose, then install the water pump and bracket by sliding it over the two inside bumper bolts on the passenger side and securing it with the supplied M8 flange nuts. Slide the outlet hose onto the inlet tube of the heat exchanger then secure it by sliding the hose clamp up and into place.

51. Route the long molded hose under the fuse box to the intake of the water pump. Hold the passenger side shroud in place to visualize where the hose will pass through it, then use a stepped drill bit to cut a 1" diameter hole in the shroud.



52. Feed the inlet hose through the hole in the shroud and clamp it to the water pump intake, then reinstall the passenger side shroud.

53. Install the long 3/4" hose onto the driver side barb of the heat exchanger and secure it with a clamp.



54. Extend the slot in the driver side shroud that allows the power steering hard lines to pass through it, then reinstall the shroud.



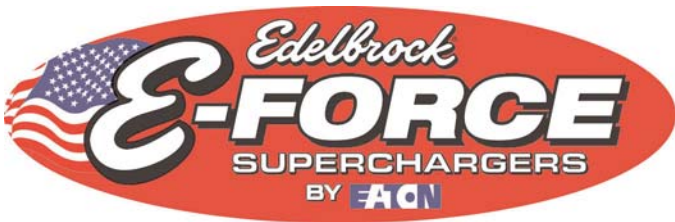

Edelbrock 4.6L Ford Supercharger System for 2010 and later Mustang GTs

Installation Instructions

VII. Wiring

55. Mount the relay on the front of the fuse box housing next to the ECU.



56. Route the ground wire to the inside grounding bolt.

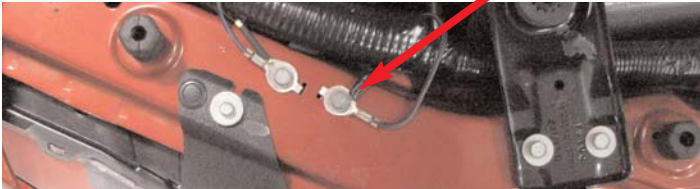

57. Route wires under the fuse box and attach the fuse holder to the passenger side strut tower with a 10mm socket and the M6 bolt supplied in hardware bag #7. The large white electrical connector can be removed by sliding it to the right for easier access to the bolt. Replace the connector once the fuse holder is mounted.

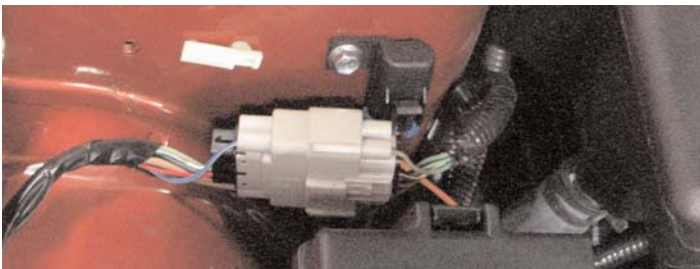

58. Use a 10mm socket to attach the power wire to the power terminal on the fuse box



59. Route the water pump electrical connector below the fuse box and around the washer fluid reservoir and plug it into the intercooler water pump. Route the round 4-pin connector back to the firewall and plug it in to the harness previously occupied by the CMCV connector.



60. Locate the ETC electrical connector on the main engine wiring harness and connect it to the ETC extension harness.

NOTE: Edelbrock is in the process of acquiring OEM harness connectors to supply with superchargers. Compare the connectors you have received with those on the vehicle. If they match, you may skip the following TPS & EVAP depinning procedures.

61. Locate the TPS connector on the passenger side of the main engine wiring harness. Use a small pick or screwdriver to release the center locking tab while prying up on the white wedge lock.

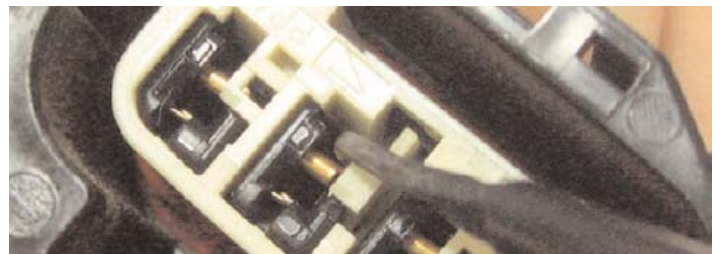

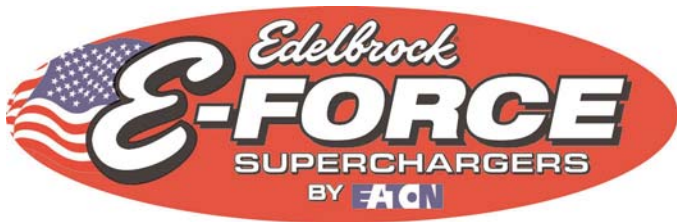

Edelbrock 4.6L Ford Supercharger System for 2010 and later Mustang GTs

Installation Instructions

62. Use a de-pinning tool, needle or safety pin to slide under the terminal and lift the locking tab while pulling gently on the corresponding wire to de-pin the connector. De-pin all four wires and remove the connector.

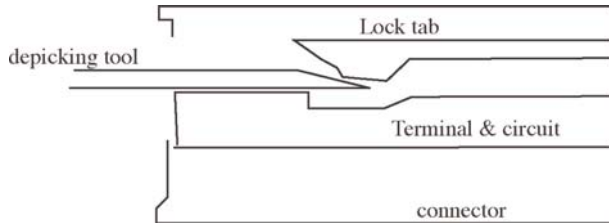

Recommended Tools

63. Detach the TPS connector from the TPS/Alternator extension harness and raise the wedge lock by pushing the center lock tab and pulling up. Align the slot on the wire terminal with the tab in the connector, then insert the green wire with the violet stripe into Pin 1 of the TPS Connector and seat it gently.

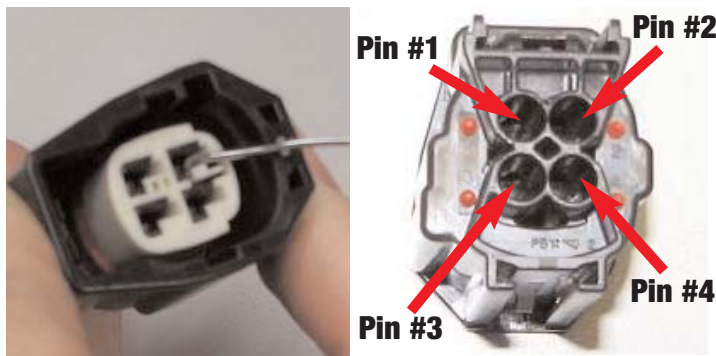

64. Insert the yellow wire into Pin 2 of the TPS Connector and seat it gently.

65. Insert the blue wire with the orange stripe into Pin 3 of the TPS Connector and seat it gently.

66. Insert the brown wire into Pin 4 of the TPS Connector and seat it gently. Depress the white wedge lock to secure the wires in place.

67. Attach the electrical connector of the TPS/Alternator wiring harness to the connector you just installed.

68. Locate the electrical connector on the main harness previously occupied by the alternator control wiring harness. Attach the round alternator connector on the supplied TPS/Alternator harness into this connector and route the harness around the back of the engine bay, then forward along the driver side cylinder head.

VIII. Cooling System Modifications

69. Remove the two inner passenger side strut tower nuts and hang the recovery tank bracket from the exposed bolts. Do not reinstall strut nuts at this time. Bend the A/C service port slightly so that it is positioned between the recovery tank and the passenger side fender.



70. Attach the long molded hose to the bottom barb of the tank and secure it with a clamp.



71. Reinstall the foam bumper insulator and secure it in place with the stock body pins.

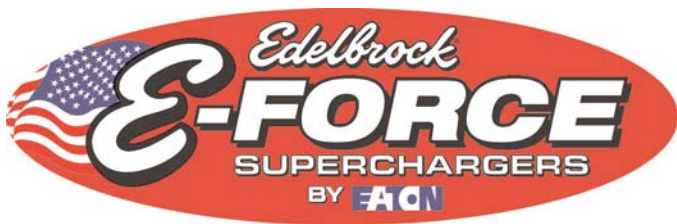

Edelbrock 4.6L Ford Supercharger System for 2010 and later Mustang GTs

Installation Instructions

72. Reconnect the fog lights and indicators, then replace the fascia onto the front of the car.

73. Reinstall the screws and push in rivets that secure the inner fender wells, then reinstall the upper front fascia bolts.

74. Replace the lower splash shield and secure it with the stock fasteners. The vehicle can now be lowered.

75. Two hard coolant lines are held in place in the engine valley by a bracket bolted to the rear of the passenger side cylinder head. Remove the bolt holding this bracket in place, then unclip the lower hose from the firewall.



76. Unclamp the upper hose from the hard line, then remove both hard lines, being careful not to damage the nipple in the bottom of engine valley.

77. Place the coolant pipes in cloth wrapped vice jaws to avoid damaging them, then use a hacksaw or cut-off wheel to separate the tubes by cutting the two brackets, as shown below.



78. Once the coolant pipes have been separated, reinstall the smaller diameter of the two by gently sliding it onto the nipple in the engine valley and securing it onto the back of the head with the stock bolt. The lower hose and larger diameter hard line can be discarded.



79. Reattach the upper heater hose to the hard line with the stock hose clamp.

IX. Installing New Components

80. Use a 13mm socket to remove the two idler pulleys on the driver's side of the engine, but save one of the mounting bolts for later.



81. Install the smaller of the two Edelbrock supplied idler pulleys onto the alternator bracket with the open end facing the bracket. Secure it with a small amount of blue Loctite applied to the bolt saved in the previous step, then use a 13mm socket to torque it down to 18 ft/lbs.



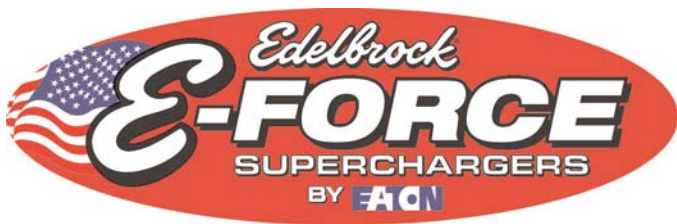

Edelbrock 4.6L Ford Supercharger System for 2010 and later Mustang GTs

Installation Instructions

82. Remove the alternator mounting stud on the driver's side of the engine using a 5.5mm socket, or thread a second nut onto the stud as shown, and use a 13mm wrench on the nut closest to the block to remove the stud.



83. Use 13, 15 & 18mm sockets to remove the driver side front cover nuts, bolts and studs, as shown below.

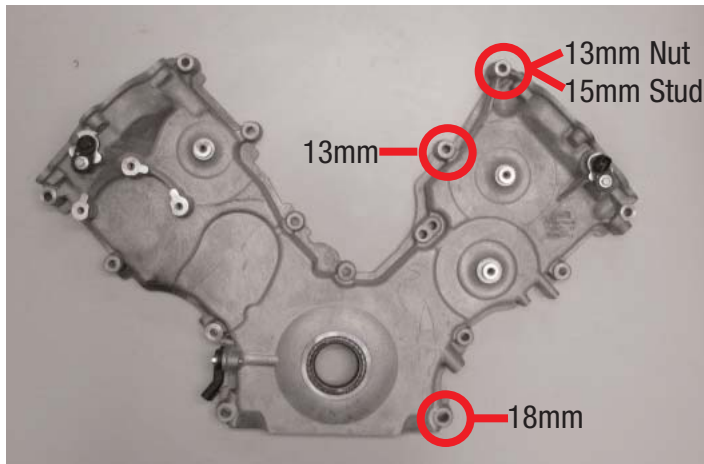

84. Slide the larger of the two Edelbrock supplied idler pulleys onto the lower idler boss of the front cover with the open side facing the engine block.



85. Use a 12mm deep socket and a small amount of blue loctite to install the alternator bracket using the bolts supplied in hardware bag #3. The upper two provisions will use the 65mm bolts, while the bottom provision will use the 75mm bolt. The center hole will use a 35mm bolt that will pass through both the bracket and pulley, and then thread into the front cover.

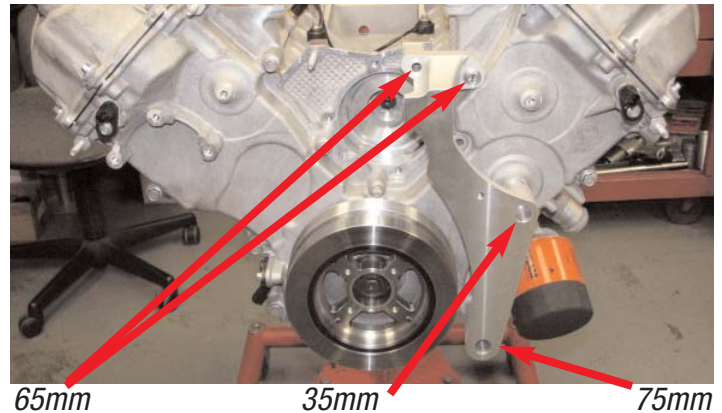

XI. Installing the Supercharger

86. Install the Edelbrock supplied heater hose on the firewall connector, and lay it to the side for now.



87. Remove the supercharger assembly from its packing container and install the supplied o-ring seals into the grooves on the bottom of the runners. Be sure to line up the tab on the o-rings with the notches provided.



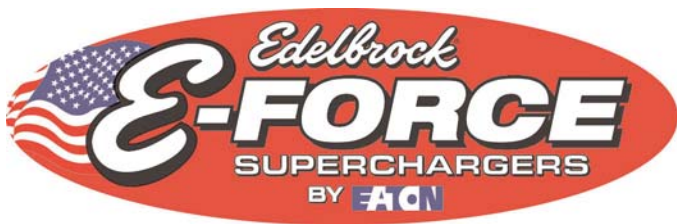

Edelbrock 4.6L Ford Supercharger System for 2010 and later Mustang GTs

Installation Instructions

88. Be sure that the engine bay and environs are clean and free of debris, then remove the masking tape used to protect the intake ports from contamination.

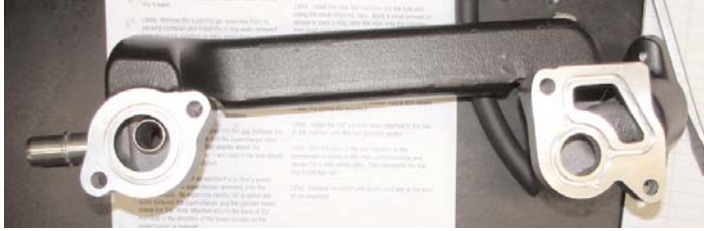

89. Install the o-ring gaskets removed from the stock water crossover into the supplied crossover.



90. Insert the water crossover into the gap between the intercooler manifold and the supercharger drive pulley. There are no bolts that directly attach the crossover to the manifold, so it will need to be held steady as the supercharger is installed.

91. With the help of an assistant or a cherry picker, carefully lower the supercharger assembly onto the cylinder heads. Be especially careful not to pinch any wires between the supercharger and the cylinder heads. Orient the attached 3/8" hose around the back of the manifold in the direction of the brake booster as the supercharger is lowered.

92. Push the supercharger to the rear of the engine bay so that the bolts supplied in hardware bag #6 can be inserted into the provisions on the crossover. Pull the crossover forward against the bolts, then torque them to 7-1/2 ft/lbs with a 10mm socket.

93. Ensure correct alignment of the supercharger by looking through the injector holes to verify that they are aligned with the injector provisions of the cylinder head and that the manifold is centered left to right as well as front to back on the engine block.

94. Use a 10 mm socket to install the intake bolts supplied in hardware bag #1 then torque them to 8 ft/lbs in the sequence shown below.

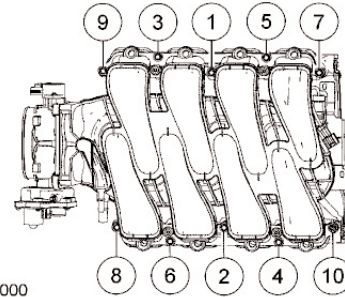

N0014000

95. Install the new fuel injectors (not included in 1585) into the stock fuel rails by applying a bit of o-ring lube to both o-rings of each injector, sliding the stock retaining clips onto the injectors, then pushing each injector into the rail until the clips snap into place.



96. Align each of the fuel injectors with its prospective well, then pull the top of the rail outboard so that the brackets will clear the runner flanges as you push the rail down. Make sure that the TMAP wiring harness is routed below the driver side rail. The rails and injectors are fully seated once the rail brackets contact the runner bosses. Use a 5mm allen tool to secure the rails with the M6 socket head bolts supplied in hardware bag #2.



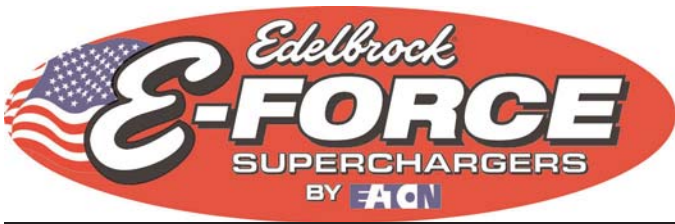

Edelbrock 4.6L Ford Supercharger System for 2010 and later Mustang GTs

Installation Instructions

97. Install the 3/8" vacuum hose attached to the rear of the manifold onto the brake booster nipple and secure it with the spring clamp provided.



98. Install the 1/4" vacuum hose attached to the rear of the manifold onto the fuel pressure sensor.

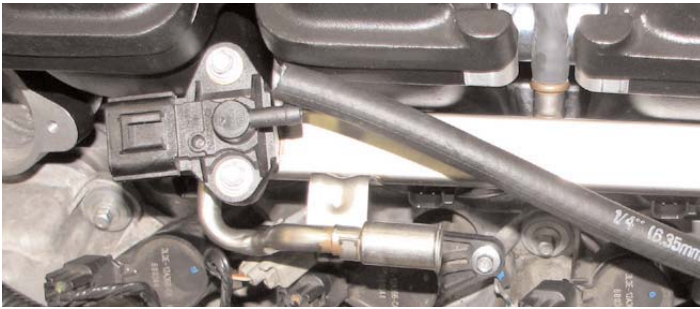

99. Connect each of the fuel injectors to the appropriate terminal on the main wiring harness, then reconnect the fuel line to the fuel rail and secure it with the lock clip.



100. Connect the EVAP hose to the hard line at the front of the manifold.



101. Reconnect the fuel pressure sensor to the main wiring harness. Be sure to use the connector that does not have a red locking tab, the connector with a red locking tab is for the TPS.



102. Plug the MAF/IAT wiring harness into the IAT sensor that is located on the rear, passenger side, of the supercharger.

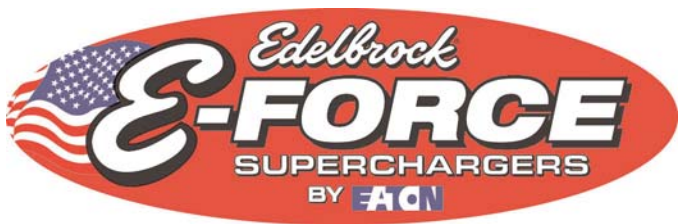

Edelbrock 4.6L Ford Supercharger System for 2010 and later Mustang GTs

Installation Instructions

XII. Modifying Stock Components

103. Use a 10mm socket to loosen the three bolts that hold the tensioner in place and remove the arm.

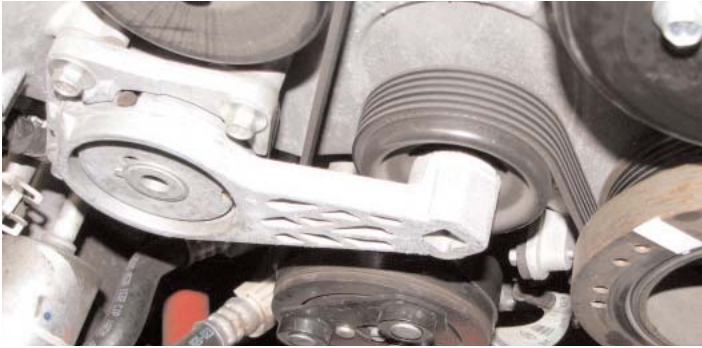

104. Place the tensioner in a cloth wrapped vice and use a grinding wheel or hacksaw to remove the stop.

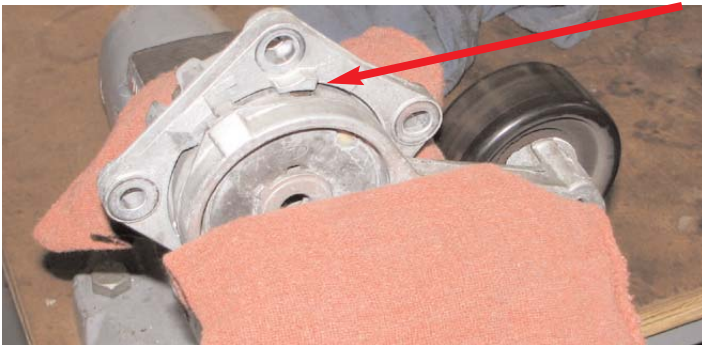

105. Use a grinding wheel or file to ensure that the area that was ground down is smooth and free of burrs.

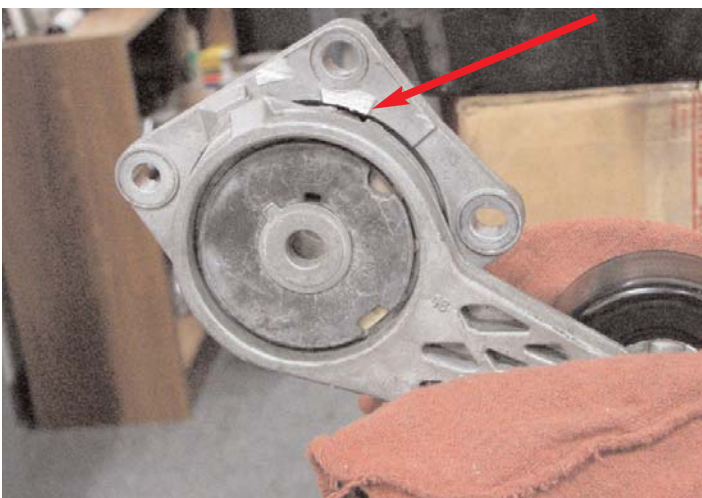

106. Use a 10mm socket to install the three tensioner brace bolts, making sure to line up the square holes.



107. Use a 10mm socket to reinstall the tensioner.

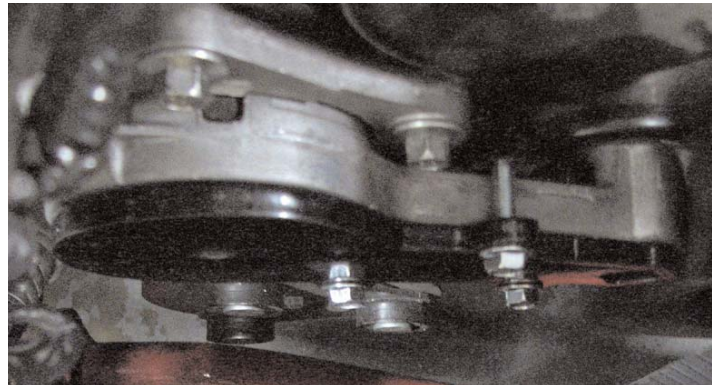

108. Use a 17mm allen tool with an impact wrench to remove the stock pulley.



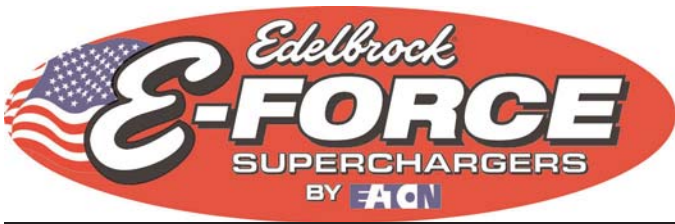

Edelbrock 4.6L Ford Supercharger System for 2010 and later Mustang GTs

Installation Instructions

109. Remove the rear cover of the alternator by unscrewing the three 8mm nuts holding it in place.

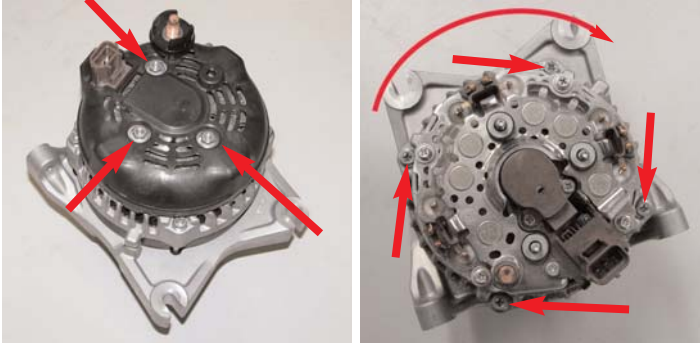

110. Remove the four screws that fix the position of the stator assembly within the alternator body, then use a vice or an assistant to hold the alternator body steady while the stator is rotated clockwise 90° so that the bolt holes line up once again.



111. Once the stator has been rotated, reinstall the bolts securing it to the alternator body, then reinstall the rear cover and the three nuts that hold it in place.

112. Install the new alternator pulley using an impact gun with the nut supplied in hardware bag #3 and red Loctite. **WARNING:** Failure to install the nut in the manner described above will result in the nut loosening, causing catastrophic damage to the engine's front cover.



113. Attach the stock protective boot to the new alternator power wire and fasten it to the alternator terminal with a 10mm socket. Route the wire around the back of the engine towards the battery, then attach the new alternator control wiring harness connector from the TPS/Alternator extension harness to the alternator.

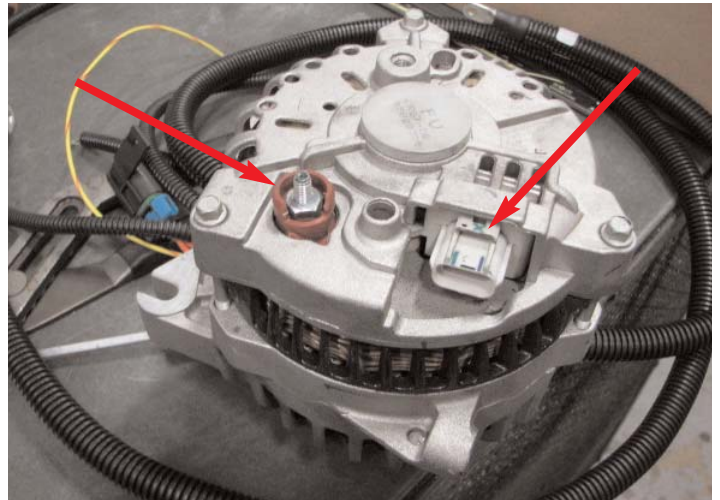

114. Thread the serpentine belt through the alternator bracket and over the alternator pulley before securing the alternator to the bracket with the two M8 x 40mm bolts supplied in hardware bag #3. Verify that the alternator is fully seated on the bolts before torquing them to 18 ft/lb.



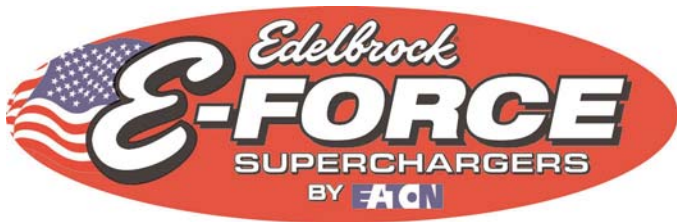

Edelbrock 4.6L Ford Supercharger System for 2010 and later Mustang GTs

Installation Instructions

115. Use a 12mm socket to fasten the alternator strap to the front cover using the M8 x 60mm long bolt supplied in hardware bag #3 then tighten it to 18 ft/lbs. Place the electrical noise isolating capacitor (not shown) in front of strap then secure the strap to the alternator with the M6 x 20mm bolt from hardware bag #3 and tighten to 8 ft/lbs.

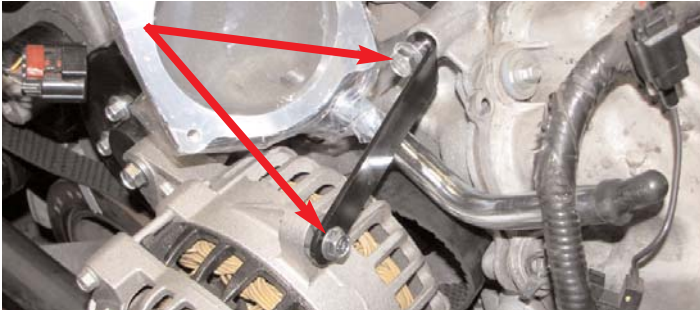

116. Route the supplied serpentine belt according to the diagram provided below by using a 1/2" breaker bar to twist the belt tensioner enough to allow the belt to slide into place.

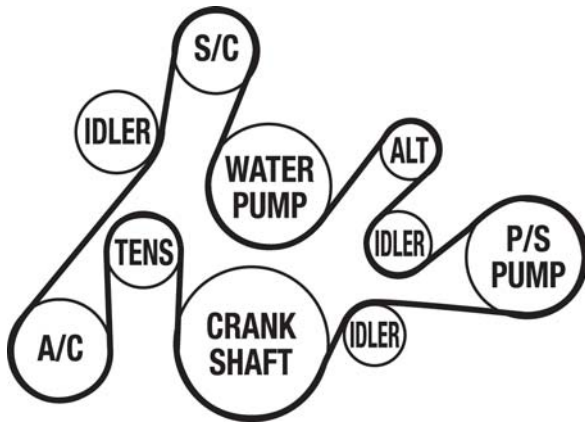

117. Trim the stock power steering hoses to fit the new fluid reservoir location and attach them. Mount the reservoir on the radiator fan shroud using the stock bolt. Fill the new power steering reservoir to the cold fill line.

XIII. Installing the Throttle Body

118. Use 8mm and 10mm sockets to unbolt the OEM throttle body from the stock intake manifold, using care not to damage the motor housing.



119. Use a T20 Torx driver to remove the motor housing, plastic capped spring, and TPS from the OEM throttle body. **WARNING:** Rotating the TPS when removing or installing it may damage the internals beyond repair.

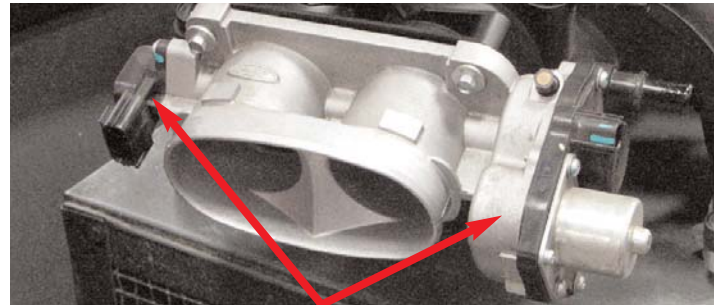

Plastic Capped Spring

ETC

TPS

120. Carefully remove the motor housing cap.

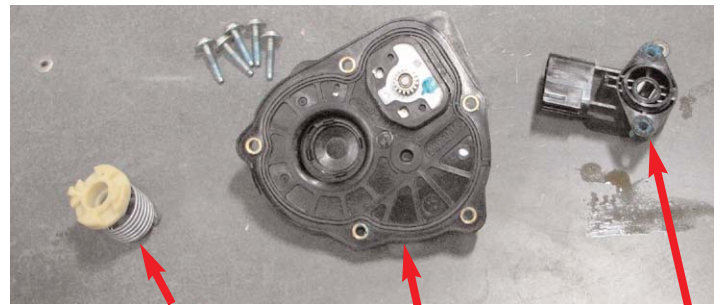

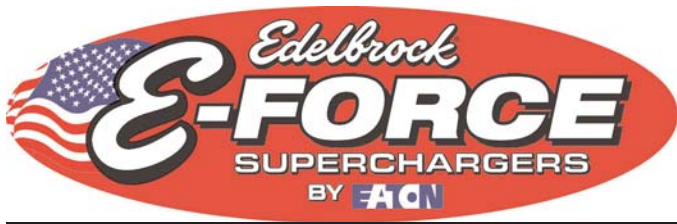

Edelbrock 4.6L Ford Supercharger System for 2010 and later Mustang GTs

Installation Instructions

121. Install the plastic capped spring into the new Edelbrock supplied throttle body so that the pigtail end is hooked into the catch slot of the gear on the end of the throttle shaft.

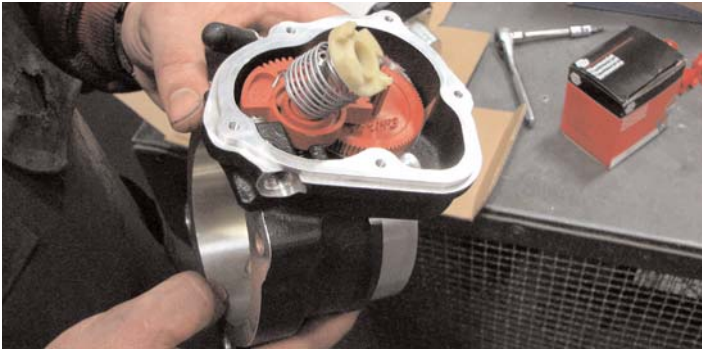

122. Install the ETC motor over the plastic capped spring and tighten the screws that hold it in place.

123. Use needle nose pliers to rotate the plastic spring cap roughly half a turn **counter-clockwise** until the two tabs line up with the notches in the motor housing. Pull up on the cap until it snaps into place.



124. Reinstall the motor housing cap by lining up the tabs and applying light pressure.

125. Reuse the stock bolts to install the TPS on the new throttle body by lining up the locating tab and pushing it straight on. Be careful to avoid rotating the TPS during installation.

126. Verify correct installation by pushing the butterfly open and closed a few times, making sure that it doesn't stick or bind in a particular position. Be sure that the throttle blade returns to the closed position when released before proceeding.

127. Align the throttle body gasket on the flange, then install the throttle body onto the inlet elbow with the bolts supplied in hardware bag #4. Open the throttle blade and align the two parts so that there is a smooth transition before tightening the bolts.



128. Install the new high flow air filter in the stock airbox.

NOTE: The resonator hose that connected the stock air box to the firewall will not be reinstalled. Install supplied plug from bag #5 into hole in firewall previously occupied by the resonator hose.

129. Use a T20 Torx driver to remove the MAF sensor from the stock airbox cover. Install the stock MAF sensor in the new airbox cover and torque the two screws that retain it to 18 in/lbs., then install the new cover.



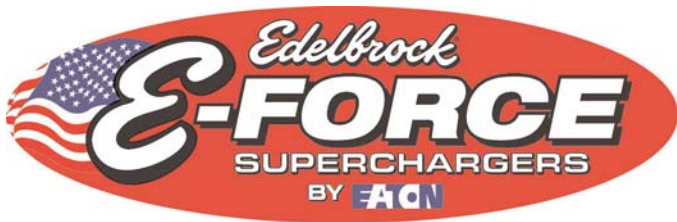

Edelbrock 4.6L Ford Supercharger System for 2010 and later Mustang GTs

Installation Instructions

130. Separate the MAF harness connectors located at the rear of the airbox. Connect the two harnesses to the connectors on the supplied TMAP/MAF harness and attach the wire harness to the tab on the airbox.



131. Install the throttle body elbow onto the throttle body and secure it with the provided hose clamps. The flexible elbow should be oriented so that it can be easily mated to the air cleaner cover outlet tube.

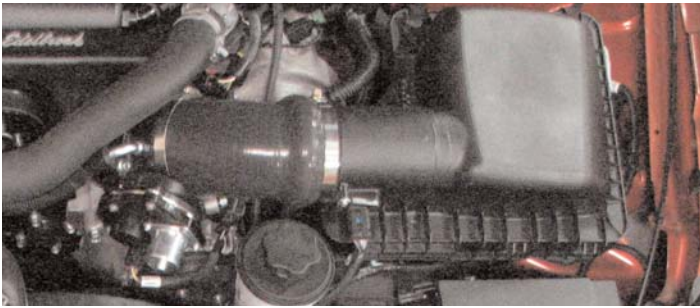

132. Route the new driver side PCV hose between the valve cover and intake elbow, then install the passenger side PCV hose between the fitting on the throttle body and valve cover.



133. Install the ETC extension harness and attach the electrical connectors for the TPS and ETC stepper motor.

134. Install the 12" piece of 3/4" hose from the recovery tank to the intercooler manifold fitting. Secure each end with a clamp.

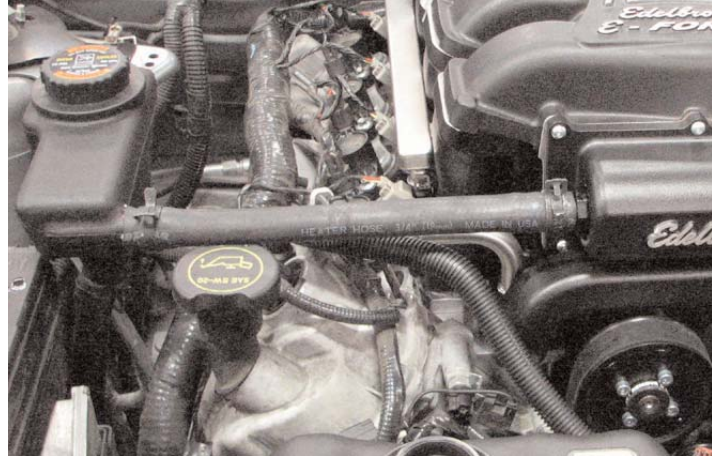

135. Route the other end of the long hose previously attached to the driver side outlet of the intercooler up to the intercooler manifold outboard of the A/C line, avoiding close proximity to the exhaust manifold and power steering pump, and attach it to the manifold fitting with a clamp.

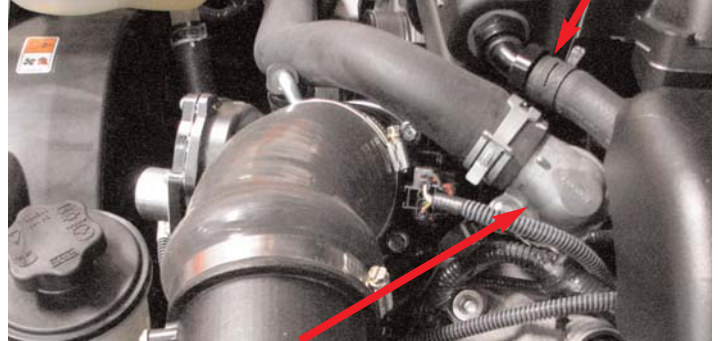

136. Install the thermostat, o-ring & housing onto the driver side of the water crossover. Torque the thermostat housing bolts to 7-1/2" ft/lbs. Install the stock molded hose onto the thermostat housing and line the other end up with the passenger side radiator fitting. Trim 1-1/2" from the radiator side of the hose to achieve the best fit.



Edelbrock 4.6L Ford Supercharger System for 2010 and later Mustang GTs

Installation Instructions

137. Install the supplied heater hose from step #90 onto the heater tube on the passenger side of the water crossover.



138. Verify that the coolant petcock is closed, then refill the coolant system.

139. Fill the intercooler system with a 50/50 blend of water and coolant poured into the recovery tank. Fill the tank until the water level is roughly 1" from the top of the threaded neck.

XIV. Installing Coil Covers

140. Lift the recovery tank off the strut tower bolts and fold it forward.



141. Install the coil cover brackets onto the coil covers with the raised portion of the bracket facing towards the top of the cover, while the lower 'L' portion faces in towards the center of the cover, as shown below.



142. Apply a small amount of blue loctite to the thread of each bolt supplied in hardware bag #8, then tighten them into the threaded holes of the coil covers.



143. Remove the engine oil dipstick, then pull the main wiring harnesses off the valve cover studs on both sides of the engine bay.

144. Lube the grommet supplied with the driver side cover with silicone spray, then slide it over the dipstick tube and wiggle it into place with your thumbs as you lower the driver side cover into place.



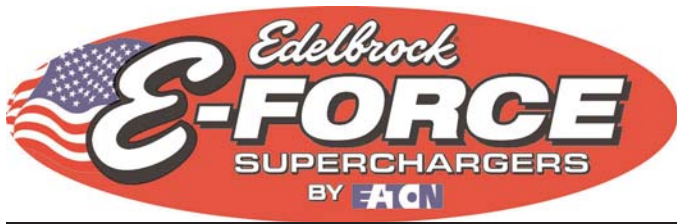

Edelbrock 4.6L Ford Supercharger System for 2010 and later Mustang GTs

Installation Instructions

145. Lower the driver side coil cover into place, orienting the bracket so that it lines up with the bolt provision below the TMAP sensor. Use caution not to pinch the TMAP wire harness as you are fastening the cover bracket to the runner with the supplied thumb screws. Verify that the cover stands are flush on the valve cover and not pinching any wires or hoses. Install the oil dipstick.

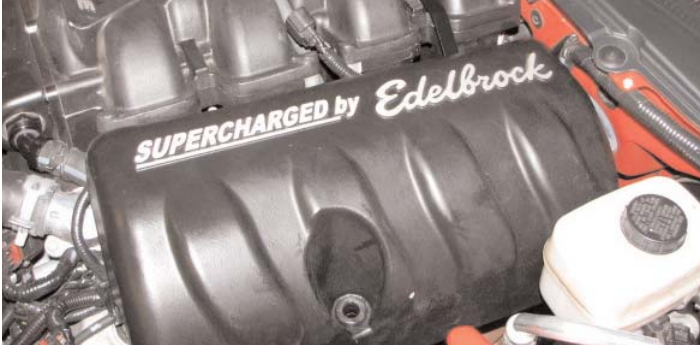

146. Install the passenger side cover by lowering it into place and fastening the thumbscrews. Use caution not to pinch any wire harnesses or heater hoses.

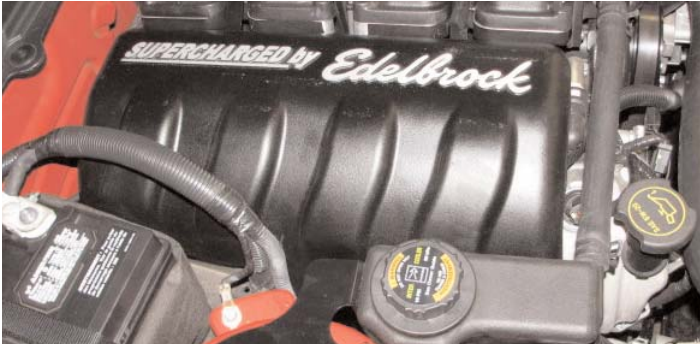

147. Replace the recovery tank on the strut tower bolts, then install and torque the strut tower nuts to 26 ft/lbs.

148. Reinstall the battery tray, battery, protective sleeve and tie down strap, then secure the battery. Reconnect the positive and negative clamps to their respective terminals, and connect the new alternator power wire to the positive battery terminal.

149. Turn the ignition key to the 'ON' position.

150. Verify that water is flowing briskly through the recovery tank, then install the cap.

151. Have an assistant support the hood while you tighten the four bolts that secure it to its hinges. Be careful to verify that it is properly aligned and that the supercharger has nothing on top of it before you attempt to close the hood.

152. Reattach the washer nozzle hose and replace any hood insulator body pins that were removed.

XV. Flashing the ECU

153. It is recommended that you check the Edelbrock that you have the latest calibration. Once you have found the latest tune on the site, power on the programmer, press the left arrow and select the Device Info option. Scroll down to Tune Version and compare that number to the one on the site. If they are different, download the new calibration with the supplied USB cable.

154. Plug the supplied programming module into the OBD-II port of the car, located below the steering column.

155. Once the main menu has loaded, press the central 'select' button on the controller to access the 'Performance Tune' option.

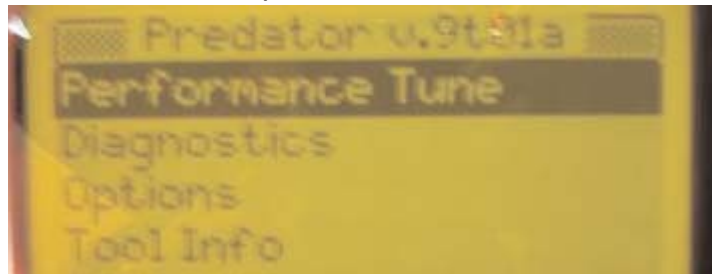

156. Read the disclaimer carefully, then choose 'Agree' and press select.

157. Use the arrow buttons to select your transmission, then press select to confirm your selection.

158. Select 'Edelbrock E-Force 5psi' from the menu.

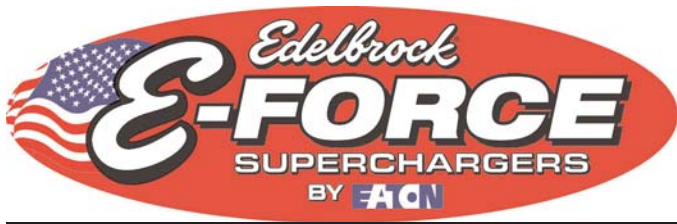

Edelbrock 4.6L Ford Supercharger System for 2010 and later Mustang GTs

Installation Instructions

159. Read the description and press select.

160. The programmer will automatically save a copy of your existing engine tune. Press select to continue.

161. Turn the ignition key to the 'OFF' position when prompted, but do not remove it.

162. Turn the ignition key to the 'ON' position when prompted, but do not attempt to start the car. The programmer will automatically start saving the stock calibration.

163. Once complete, follow the on-screen prompts regarding key position until you are given the option to 'Install Tune' or 'Modify Tune'. Choose 'Modify Tune' and press select.

164. Read the disclaimer and press select.

165. Select 'Modify Parameters' and press select.

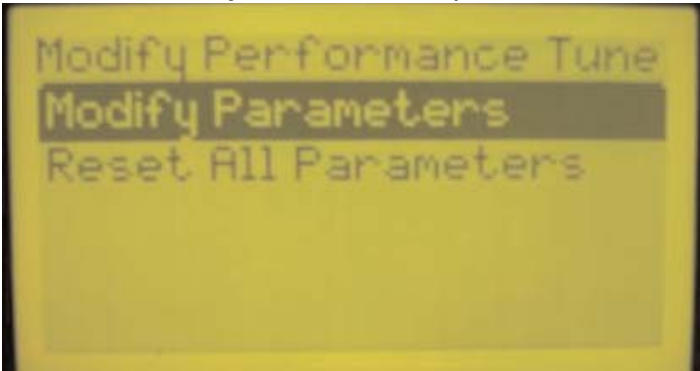

166. Press select to choose 'Axle Ratio'.

167. Press select to choose 'Axle Ratio', again.

168. Use the directional buttons to choose the number closest to your axle ratio (printed on the differential cover) and press select.

169. Press select to confirm your choice.

170. An asterisk will appear next to the 'Axle Ratio' option to signify that your changes have been saved. If your Mustang is equipped with non-stock tires, choose the 'Tire Revs per Mile' option and press select; otherwise, proceed to step 166.

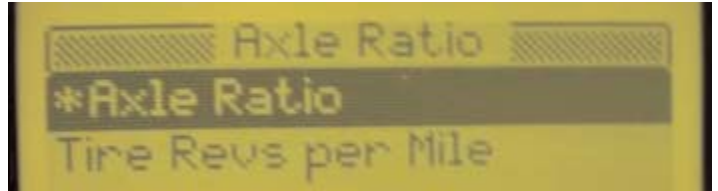

171. You will need to check your tire manufacturer's website to determine the tire revolutions per mile for your tires. The stock tires get 771 revs per mile.

172. Use the directional buttons to select the number closest to the tire revs per mile figure provided by your tire manufacturer. Press select again to confirm your selection.

173. Press escape twice to return to the Performance Tune menu. Choose 'Install Tune' and press select.

174. Confirm your choice by pressing select.

175. Follow the on-screen prompts regarding key position until you receive notification that the tune installation is complete.

176. When the download is complete you will be prompted to disconnect the DiabloSport Performance Tuner from the OBD-II port of your vehicle.

177. If you have access to a diagnostic scan tool, run a 'Key On, Engine Off' test to verify that all connectors are properly installed, otherwise move on to the next step.

178. Start the car and verify a smooth idle. If you are using a diagnostic scan tool, run a 'Key On, Engine Run' test.

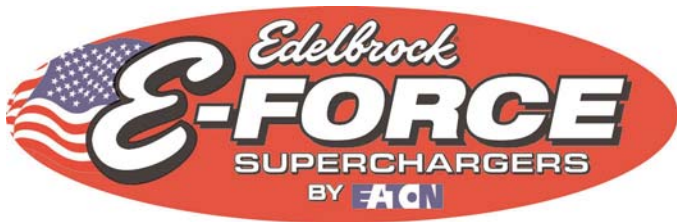

Edelbrock 4.6L Ford Supercharger System for 2010 and later Mustang GTs

Installation Instructions

Supercharger Accessories



The DiabloSport PC Interface kit includes an AC Adapter and serial to USB adapter cable for uploading custom calibrations into the handheld programmer and from there to the ECU of your vehicle to allow full control over the operation of your engine.

DiabloSport PC Interface Kit (USB).....#15809