



Picture for reference only. Additional equipment not included.

**Edelbrock E-Force Pro-Tuner Supercharger
2015-19 Ford Mustang 5.0L, 5.2L, GT350, Bullitt
Part #'s: 15899**



WARNING!

The supercharger bypass valve is factory installed and adjusted intended to be vacuum operated only. DO NOT move the solenoid actuator lever by hand or adjust the stop point. Moving the lever manually will damage the solenoid and the system will not function properly. Damage to the bypass assembly from manual movement will not be covered under manufacture warranty.



Edelbrock Pro-Tuner Supercharger System 2015-19 Ford Mustang 5.0L, 5.2L Installation Instructions

INTRODUCTION

Thank you for purchasing the Edelbrock E-Force Pro-Tuner Supercharger for the 2015-19 Ford Mustang 5.0L. The Edelbrock E-Force Supercharger System utilizes Eaton's TVS Supercharger rotors, featuring a four lobe design for maximum efficiency, minimum temperature rise, quiet operation, and superior reliability. The inverted design places the supercharger down low in the valley, allowing for extra long runner lengths, maximizing low end torque. Installation time: 9 Hours.

ADDITIONAL PARTS REQUIRED

Recommended Belt and Pulley Sizes

Maximum allowed Supercharger Pulley Size is 3.75" due to idler pulley clearance

6 Rib Pulley	Boost	Recommended 6 Rib Belt
3.25" Supercharger Pulley (PN 15821)	10-11 psi	82" Belt (Continental 4060820)
3.00" Supercharger Pulley (PN 15822)	12-13 psi	81.750" Belt (Gates K060812HD)
8 Rib Pulley (Kit 15879 Required)		Recommended 8 Rib Belt
3.75" Supercharger Pulley (PN 15831)	10-11 psi	87.125" Belt (Gates K080865HD or K080865)
3.50" Supercharger Pulley (PN 15813)	12-13 psi	86.125" Belt (Gates K080855HD or K080855)
3.25" Supercharger Pulley (PN 15873)	14-15 psi	86.125" Belt (Gates K080855HD or K080855)
3.00" Supercharger Pulley (PN 15872)	16-17 psi	85.750" Belt (Gates K080852RPM)
2.75" Supercharger Pulley (PN 15871)	18-19 psi	85.625" Belt (Gates K080850RPM)
2.625" Supercharger Pulley (PN 15870)	20+ psi	85.130" Belt (Gates K080845RPM)

Recommended Throttle Body

The correct throttle body is required to function properly

2015-17 Mustang 5.0L	2018-19 Mustang 5.0L
103mm Throttle Body - Analog (PN 38988)	103mm Throttle Body - Digital (PN 38989)

TOOLS REQUIRED

- | | |
|---|--|
| <ul style="list-style-type: none"> ● Jack and Jack Stands
OR Service Lift ● Panel Pullers ● Ratchet and Socket Set including 7mm, 8mm (deep), 10mm, 10mm (deep), 10mm Swivel Socket, 12mm, 13mm, 15mm, ● 5mm & 6mm Allen Sockets ● Long Ball-End Allen Wrench Set ● 19mm Wrench ● 3/8" Breaker Bar ● Screwdriver Set | <ul style="list-style-type: none"> ● Fuel Line Removal Tools ● 90° Power Drill ● 1.125" Hole-Saw Bit ● Pliers OR Hose Clamp Pliers ● 90° Pick ● Blue Thread Lock Fluid ● O-ring Lube ● Masking Tape ● Torque Wrench ● 2 Gallons Motocraft Antifreeze/Coolant
VC-3DIL-B Orange Pre-Diluted |
|---|--|



**Edelbrock Pro-Tuner Supercharger System
2015-19 Ford Mustang 5.0L, 5.2L
Installation Instructions**

IMPORTANT WARNINGS

Before beginning the installation, use the enclosed checklist to verify that all components are present in the box. Then inspect each component for damages that may have occurred in transit.



WARNING: Installation of this supercharger will result in a significant change to the performance characteristics of your vehicle. It is highly recommended that you take some time to familiarize yourself with the added power and how it is delivered. It's highly recommend to do this in a controlled environment. Take extra care on wet and slippery roads, as the rear tires will be more likely to lose traction with the added power. It is never recommended to turn off your vehicles traction control system.

Proper installation is the responsibility of the installer. Improper installation will void all manufacture's standard warranties and may result in poor performance and engine or vehicle damage.

Due to the complexity of the Edelbrock E-Force Supercharging system, it is recommended that this system only be installed by a qualified professional with access to a service lift, pneumatic tools, and a strong familiarity with automotive service procedures. To qualify for the optional supplemental warranty, it is necessary to have this system installed by a Certified ASE Technician, Ford Dealership, or an Authorized Edelbrock Installer. Failure to do so will void and/or disqualify any and all optional supplemental warranties offered with this system. Please contact the Edelbrock Technical Support department if you have any questions regarding this system and/or how your installer of choice will affect any warranty coverage for which your vehicle may qualify.



**Edelbrock Pro-Tuner Supercharger System
2015-19 Ford Mustang 5.0L, 5.2L
Installation Instructions**

IMPORTANT WARNINGS (CONTINUE)

The supercharger manifold includes a 1/8 NPT port to accommodate the installation of a boost gauge or pressure transducer. Remove the plug and replace it with a fitting to attach your gauge or sensor.

The supercharger has been pre-drilled and tapped for a 1/8" NPT fitting at the rear of the passenger side intake runner flange. There is currently a plug sealing the hole, which can be removed, and replaced with a fitting to adapt to your sensor. **CAUTION:** Never cut into the vacuum lines leading to the bypass actuator for the purpose of tapping in a boost gauge. This can result in boost pressure readings that are higher than what is actually present in the intake plenum.

Do not use a wideband oxygen sensor in place of the rear O2 sensor when dyno testing this supercharger system. The voltage signal will cause the fuel system to run lean and possibly cause engine damage.



91 octane or higher gasoline is required at all times. If your vehicle has been filled with anything less, it must be run until dry and refilled with 91 or higher octane gasoline twice prior to installation.

Failure to use the required 91 octane gasoline or higher could permanently damage your engine. Any failures associated with not using premium 91 octane gasoline or higher, will be ineligible for warranty repairs.



WARNING: Installation of this supercharger and charge air cooler may require removal and replacement of front grille, front bumpers, or other pieces which may be equipped with Advanced Driver Assistance Systems (ADAS). ADAS Systems include, without limitation:

- Forward Collision Warning
- Auto braking
- Lane Departure Warning
- Lane Keeping Assist
- Blind Spot Warning
- Rear Cross Traffic
- Rearview Camera
- And various other OEM ADAS Equipment

It is the responsibility of the installer to ensure that all necessary ADAS systems that require post-repair calibrations/targeting/aiming is performed by qualified repair facilities. Edelbrock assumes no liability whatsoever with respect to any damages or losses with respect to any ADAS systems.

Edelbrock Authorized Installer Disclaimer

Authorized installers of Edelbrock products are independent companies over which Edelbrock has no right of control. Edelbrock LLC makes no claims regarding the abilities, expertise or competency of individual employees of any authorized installer. Each authorized installer is an independent company and makes its own independent judgments. Edelbrock LLC specifically disclaims any responsibility to any party including third parties for the actions, or the failure to act, of individuals, agents or a company authorized in the installation of Edelbrock LLC products.

INSTALLATION HARDWARE IDENTIFICATION GUIDE

(Parts Are Not To Scale)

BAG #1 - MANIFOLD HARDWARE				
Item	P/N	QTY.	Description	Torque Spec
1	36-1508	10	Bolt, Hex Flange, M6 x 30mm	8 ft/lbs
2	36-1575	2	Bolt, Hex Flange, M6 x 25mm	N/A
3	38-0186	8	Bracket, Injector	N/A
4	51-7092	1	Rubber Plug	N/A
5	68-0095	16	Bolt, BHCS, M4 x 4mm	N/A
6	36-1528	4	Bolt, SHCS, M6 x 16mm	N/A
7	36-1507	4	Bolt, Hex Flange, M6 x 16mm	N/A
8	51-4093	1	O-Ring, Throttle Body (not pictured)	N/A
9	36-1535	4	Bolt, SHCS, M6 x 20mm,	
10	36-4042	4	Bolt, Hex Flange M6 x 45mm	

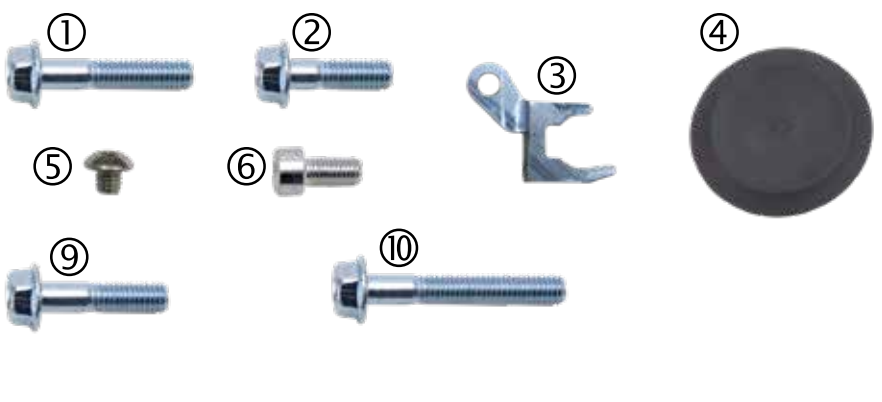

BAG #2 - FEAD HARDWARE				
Item	P/N	QTY.	Description	Torque Spec
1	36-4056	1	Bolt, Hex Flange, M10 x 110mm	22 ft-lbs
2	36-4012	1	Bolt, Hex Flange, M10 x 65mm	32 ft-lbs
3	36-4018	3	Bolt, Hex Flange, M8 x 20mm	N/A
4	36-1507	1	Bolt, Hex Flange, M6 x 16mm	N/A
5	36-3812	3	Bolt, SHCS, M8 x 90mm	22 ft-lbs
6	36-4013	1	Bolt, SHCS, M10 x 45mm	32 ft-lbs
7	36-4041	1	Bolt, SHCS, M8 x 40mm	22 ft-lbs
8	36-4057	1	Bolt, SHCS, M8 x 20mm	22 ft-lbs
9	36-4014	1	Bolt, Countersunk, M8 x 25mm	22 ft-lbs
10	82-0120	3	M8 Washer	N/A
11	36-4060	1	Shim	N/A
12	51-7058	1	Tap, 8 x 1.25, D5 Pitch Dia	N/A
13	51-7059	1	Size H Drill Bit	N/A

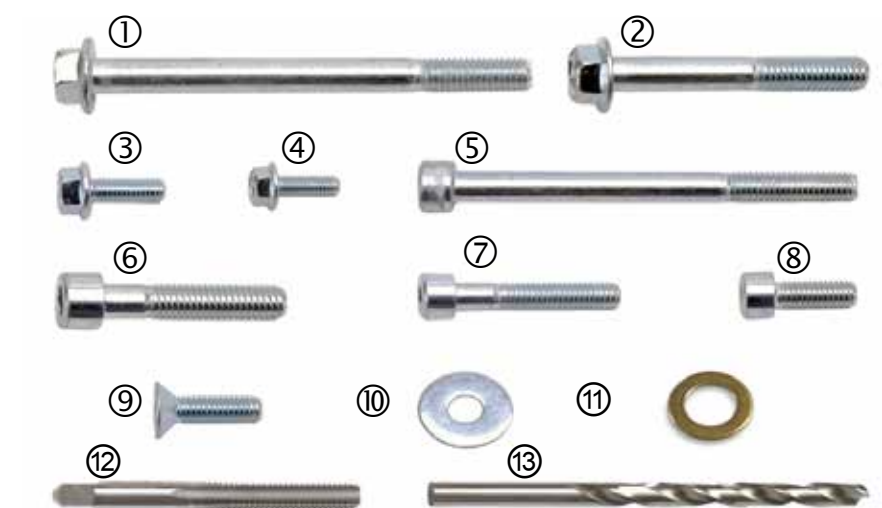

BAG #3 - INTERCOOLER HARDWARE				
Item	P/N	QTY.	Description	Torque Spec
1	36-1518	2	Bolt, Hex Flange, M8 x 30mm	N/A
2	36-1552	6	Bolt, Hex Flange, M6 x 10mm	N/A
3	36-8572	6	M8 Nut	N/A
4	82-0120	2	M8 Washer	N/A
5	46-2155	8	3/4" Hose Clamp	N/A



ADDITIONAL HARDWARE		
P/N	QTY.	Description
2-15809	1	EVAP Solenoid Hardware Bag, 2015-17 Mustang
2-15385	1	Stage II Intake Hardware Bag, 2015-19 Mustang

HOSE IDENTIFICATION GUIDE

(Parts Are Not To Scale)

INTERCOOLER AND PCV HOSES			
Item	P/N	QTY.	Description
1	56-1613	1	Hose, Brake Booster
2	56-1614	1	Hose, Coolant Bleed
3	22-1685	1	Hose, Aspirator to Elbow
4	22-15807	1	Hose, EVAP to Nose
5	22-15808	1	Hose, Chassis to EVAP
6	22-1601	1	Hose, EVAP
7	56-1607	1	Hose, Surge Tank to Water Pump
8	56-1608	1	Hose, Water Pump to LTR
9	56-1609	1	Hose, LTR to Supercharger
10	56-1610	1	Supercharger to Surge Tank
11	51-7090	1	Hose, PCV, Driver Side (2015-17)

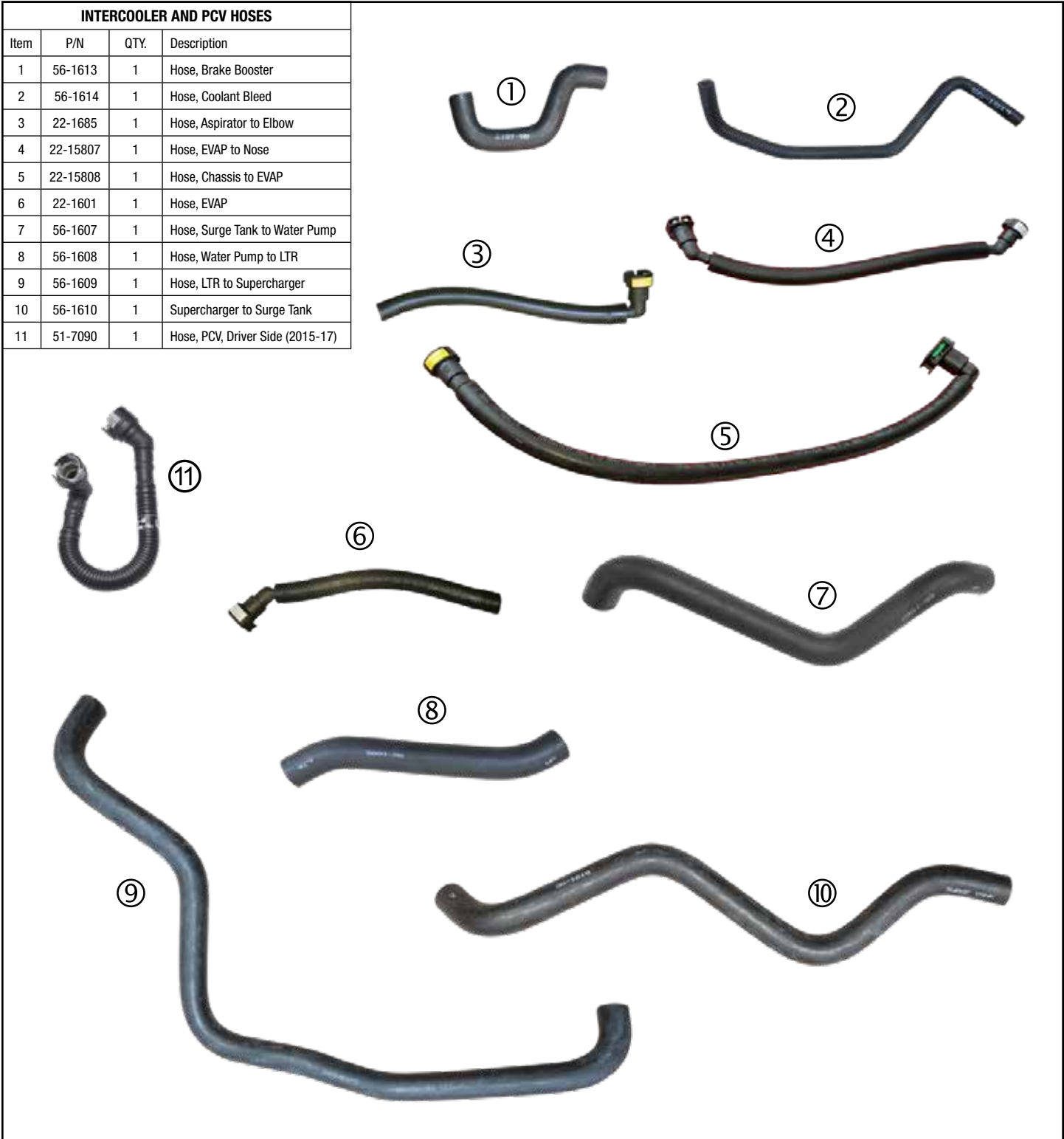

WIRE HARNESS GUIDE

WIRE HARNESSES			
Item	P/N	QTY.	Description
1	37-6627	1	ACT/MAF Sensor Harness
2	37-1913	1	Fuse Tap, 10 amp
3	37-1588	1	Water Pump/EVAP Harness

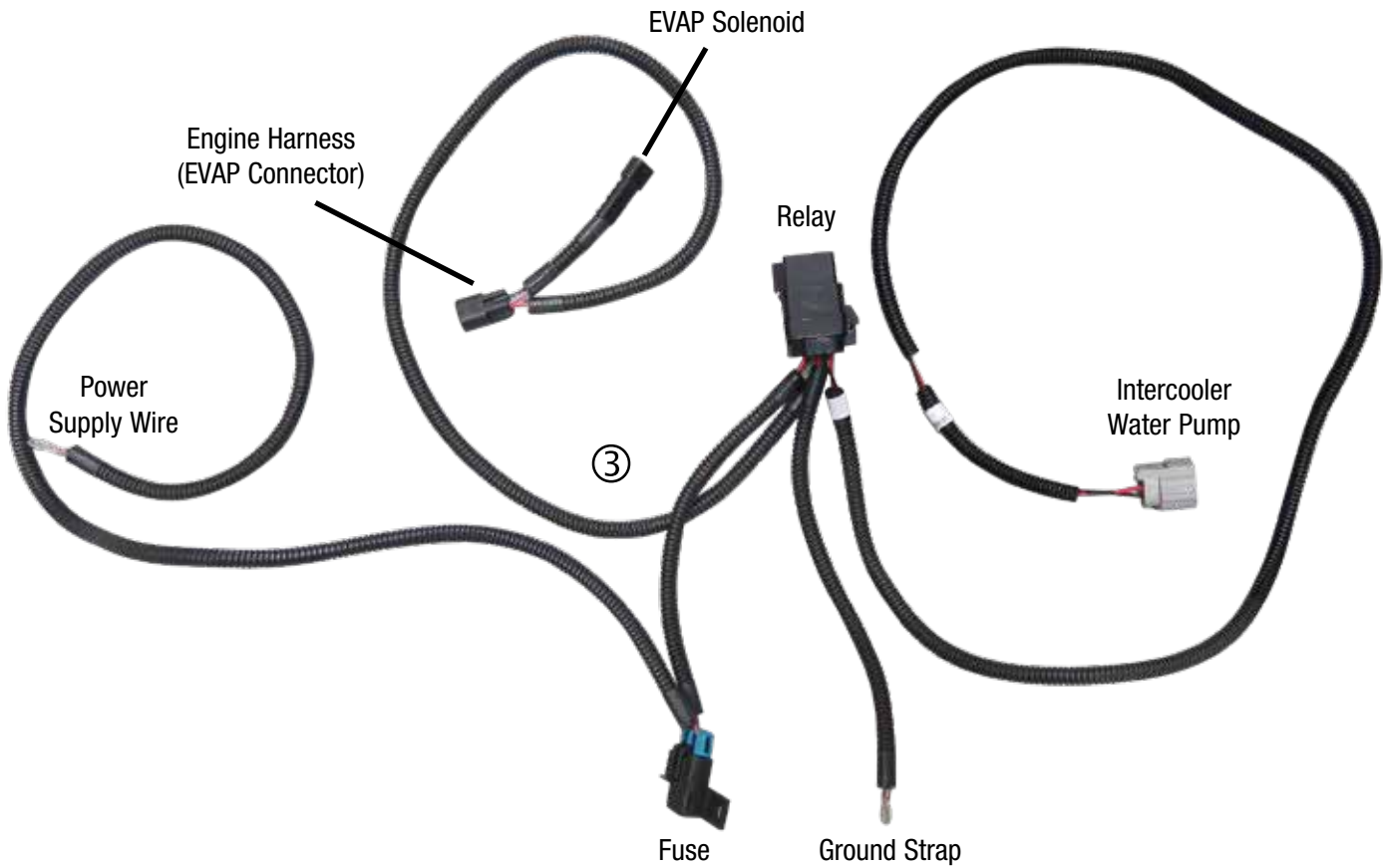
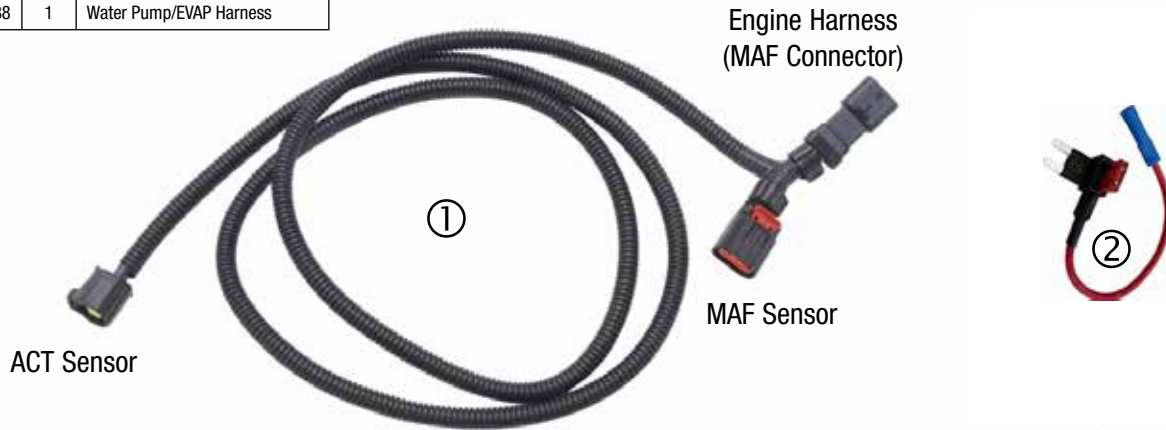

INTERCOOLER HOSE ROUTING GUIDE

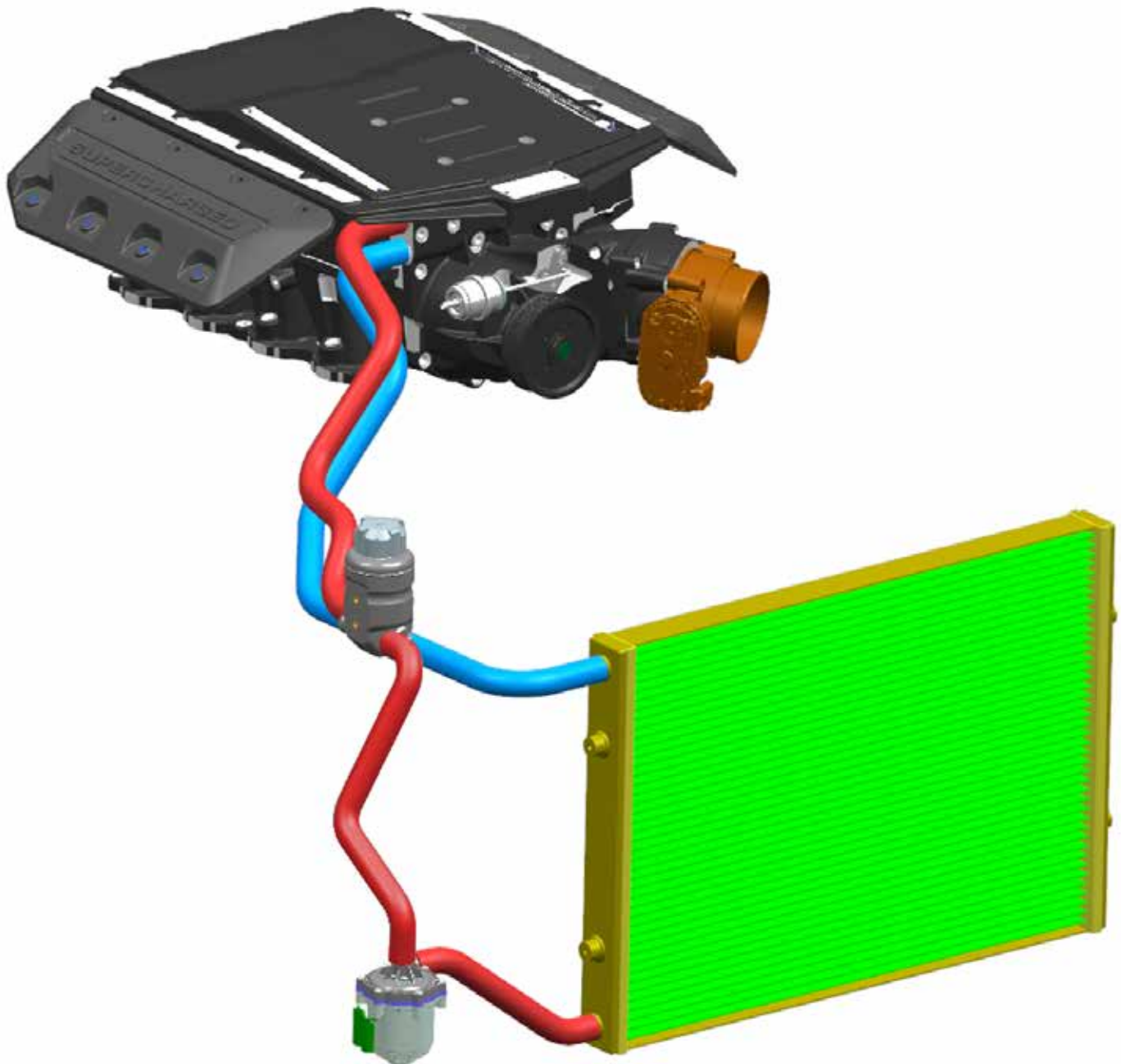

SUPERCHARGER INSTALLATION

NOTE: Some of the following images and procedures may differ on RHD (right hand drive) vehicles.

1. If equipped, use a panel puller to remove three (3) tree clips securing the battery cover.



2. Using an 10mm socket, remove the negative battery terminal and place it away from the battery. Cover the post to avoid accidental contact during the installation.



3. Using a panel puller, remove eight (8) push pins securing the top radiator shroud. Remove the shroud and set aside.



4. Remove six (6) bolts securing the top of the fascia using an 8mm socket.



5. Using a 5.5mm socket, remove two (2) bolts under the weather stripping, one per side.



6. (Fig. 1) On Performance Package Vehicles, Remove eight (8) push pins securing the splash guard using a panel puller. (Fig. 2) For all other models, remove six (6) push pins. The splash guard will be removed with the bumper.



Fig. 1



Fig. 2

Edelbrock Pro-Tuner Supercharger System 2015-19 Ford Mustang 5.0L, 5.2L Installation Instructions

7. Using a panel puller, remove three (3) push pins securing the wheel well liner to the fascia. **TIP:** Removal of the front wheels is not required but will make accessing the push pins easier.



8. There is an additional push pin located just above the tire that needs to be removed.



9. **2015-17 Models Only:** Remove two (2) bolts, one per side, securing the fascia to the fender using a 7mm socket.



10. **2018-19 Models Only:** Reaching through the shown opening, remove four (4) nuts, two per side, securing the fascia to the fender using a 10mm socket.

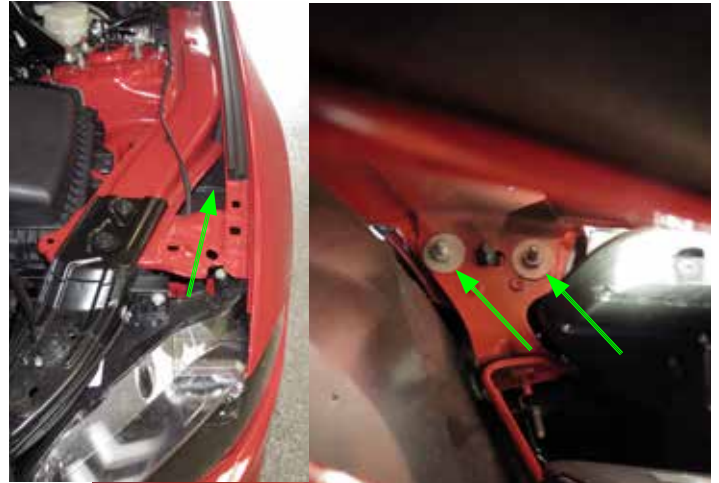

11. **2018-19 Models Only:** From within the wheel well remove the fascia retention assembly that the nuts were removed from in the previous step. Pull downward until the plastic pin no longer retains the assembly. Remove from vehicle, ensuring to distinguish between passenger and driver side.



Edelbrock Pro-Tuner Supercharger System 2015-19 Ford Mustang 5.0L, 5.2L Installation Instructions

12. Unplug the fog lamp and signal light connectors (3 lights in total), on both sides of the fascia.



13. Tape up the fender as needed to prevent scratching the painted surfaces. With the help from an assistant, carefully disengage both sides of the fascia by gently pulling the sides outwards. Remove the fascia and set aside.



14. Drain the coolant by loosening the petcock located on the passenger side of the radiator. **TIP:** Placing a hose onto the drain spout will reduce potential coolant spillage.



15. Remove the front strut tower brace (if equipped) using a 15mm socket. **NOTE:** The brace will not clear the supercharger manifold and cannot be used. The bolts securing the brace can be reinstalled once the brace is removed.



16. Gently lift up the engine cover and remove.

17. Using a hose clamp tool, or equivalent, remove the sound generator hose from the air inlet tube.



18. Remove the brake aspirator hose from the air inlet tube.



19. Remove the driver side PCV hose from the air inlet tube.



20. Remove the additional brake aspirator hose from the air inlet tube.



21. Disconnect the brake aspirator hose from the manifold PCV hose.



22. Using a flathead screwdriver, loosen two (2) worm clamps securing the air inlet tube and remove.



23. Disconnect the connector and hose from the EVAP solenoid.



24. Using a hose clamp tool and pliers, remove the brake aspirator hose from the intake manifold.



25. Remove the brake aspirator hose assembly from the brake booster and set aside as it will be reused later.



26. Remove the sound generator assembly and plug the hole in the firewall using the supplied plastic grommet plug supplied in Bag # 1.



27. Remove the passenger side PCV hose from the valve cover and the intake manifold.



28. Disconnect the throttle body connector.



29. Using an 10mm socket, remove four (4) bolts securing the heater hose retaining brackets.



30. Remove the retaining brackets and the foam insulators from the fuel rails.



31. Disconnect eight (8) fuel injector connectors.



32. With the vehicle **COMPLETELY** cooled. Put rags under the fuel rail fitting and remove the fuel line from the rail. Cap off the fuel rail and fuel line with appropriate cap and plug to prevent spillage. Clean up any spilt fuel before proceeding.



Edelbrock Pro-Tuner Supercharger System 2015-19 Ford Mustang 5.0L, 5.2L Installation Instructions

33. 2018+ Only: Repeating spill protection procedures from step 32, remove the fuel line from the passenger side fuel rail. Use a 3/8" fuel line disconnect tool to remove the line.

34. Using a 10mm socket, remove four (4) bolts securing the fuel rail and manifold. **TIP:** *It's not required to fully remove the fuel rails.*

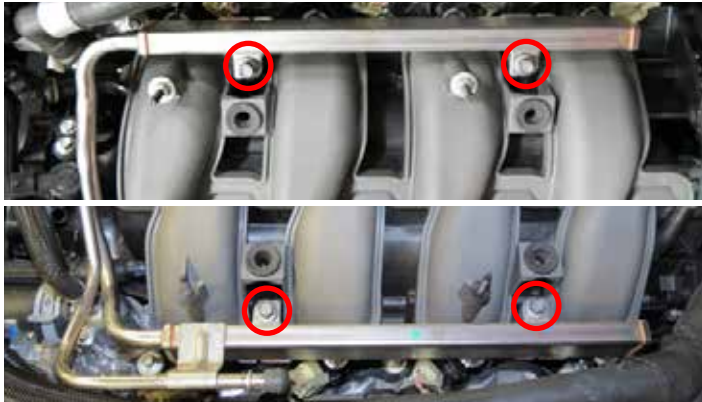

35. Using an 8mm socket, remove six (6) manifold bolts.



36. With the stock manifold remaining in the vehicle, rotate and manipulate it until you are able to remove the 4 connectors from the rear of the manifold as shown below. Disconnect any plastic anchors from the back of the manifold.

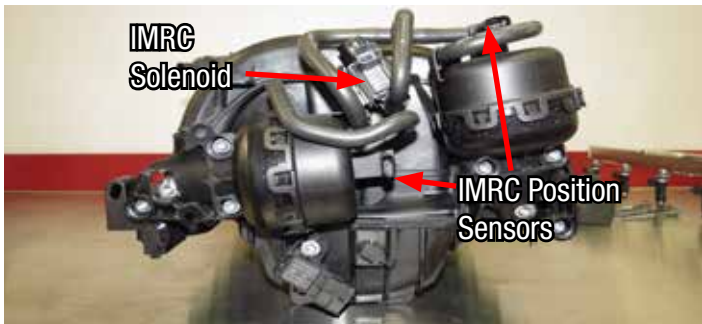

37. Make sure the IMRC harness is completely disconnected from above locations and remove the manifold. Clean the cylinder head flanges as needed and tape up the ports to prevent debris from falling into the ports. **NOTE:** Adjust the upper radiator hose clamp position to point more towards the driver's side of the vehicle. The supercharger housing will be occupying this space later. (See arrow)



38. Using a 10mm socket, remove two (2) bolts securing the coolant reservoir.



39. Position the coolant reservoir tank out of the way to access the drive belt tensioner.

40. Rotate the belt tensioner counterclockwise using a 15mm socket and breaker bar, then remove the drive belt.



Edelbrock Pro-Tuner Supercharger System 2015-19 Ford Mustang 5.0L, 5.2L Installation Instructions

41. Remove the two (2) indicated engine cover bolts using a 10mm socket. Using a 90° drill and the supplied drill bit, drill out the indicated hole on the front engine cover 1.01" deep. **(NOTE: The center hole on some vehicles will already be drilled and tapped by the factory. Please inspect your front cover and avoid drilling this hole if already tapped.)** If not already tapped, the hole in the center should be drilled .72" deep. All holes should be tapped to M8 x 1.25 with the supplied tap.

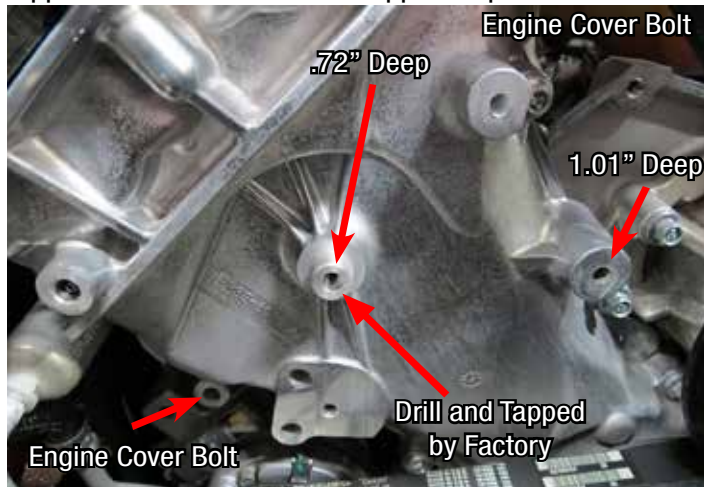

42. Secure the new tensioner bracket to the bosses that were just drilled and tapped with bolts supplied in Bag # 2.



(NOTE: When installing the countersunk bolt, place the .045" thick brass spacer between the bracket and the front engine cover if the hole was drilled and tapped by the factory.) Apply blue thread lock fluid to threads and loosely install the following four (4) bolts from Bag # 2, starting with the M8 x 25mm countersunk bolt into the countersunk feature of the bracket located on the left side of the bracket. Install the M8 x 90mm bolt through the engine cover hole at the top, then install the M8 x 40mm bolt through the hole below and to the right. Use an M8 x 90mm bolt in the counter bore feature at the lower left section of the bracket. Proceed by tightening the countersunk bolt first and then tightening the remaining surrounding bolts. Torque all bolts to 22 ft-lbs.

43. Using a 13mm socket, remove the factory tensioner adjacent to the alternator and balancer.



44. Remove both the engine cover bolt using a 10mm socket and the bolt through the ear of the alternator using a 15mm socket.



Edelbrock Pro-Tuner Supercharger System 2015-19 Ford Mustang 5.0L, 5.2L Installation Instructions

45. Secure the idler bracket by installing bolts from Bag # 2. The M10 x 110mm bolt through the ear of the alternator, the M8 x 90mm bolt into the top front cover hole, and the M10 x 45mm bolt through the lower hole that was used to secure the stock tensioner. Use blue thread lock fluid on all of the bolt threads and torque all bolts to 22 ft-lbs.

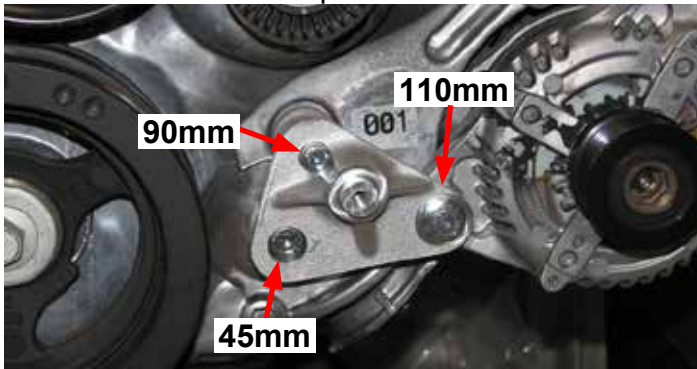

46. Install and secure the 76mm idler pulley onto the center of the idler bracket by using the M8 Washer and the M8 x 20mm bolt supplied in Bag # 2 using a 12mm socket. Use blue thread lock fluid on the bolt threads and torque to 18 ft-lbs.



47. Verify that the tensioner is clocked correctly by sliding the index through the hole on the bracket. Install the supplied belt around the tensioner pulley and torque the M10 bolt supplied in Bag # 2 with a 15mm socket to 32 ft-lbs.



48. Using the M8 x 20mm bolts and M8 washers supplied in Bag # 2, install two idler pulleys to the tensioner bracket. The top idler pulley is 65mm and the lower idler is 76mm. Add a small amount of blue thread lock fluid to the threads ONLY, do not allow excess thread lock fluid to drip onto the pulley's bearings. Torque the bolts to 18 ft-lbs.



49. Trim off the square coil harness retaining tabs located on the top of both valve covers. File down any rough edges. Also, trim off the top of the rear round edge of the passenger side valve cover. Carefully remove all debris with a shop vac.



50. Place a rag under the passenger side heater hose and remove the heater hose from the fitting located on the cylinder head. Repeat for the driver side heater hose.



Edelbrock Pro-Tuner Supercharger System 2015-19 Ford Mustang 5.0L, 5.2L Installation Instructions

51. Remove the passenger side heater hose fitting with an 8mm socket. Repeat for the driver side heater hose fitting. Temporarily plug the holes with a rag.



52. Using a hose clamp tool, remove the factory coolant bleed hose from the reservoir and bleeder fitting.



53. Remove the O-ring manifold gaskets from the factory manifold and install them onto the supercharger runners. Apply a small amount of O-ring lubricant to the exposed area of the gaskets. This will help prevent tears during installation of the supercharger.



NOTE: Steps 54 and 55 are optional if using Edelbrock Coil Covers.

54. Apply blue thread lock fluid onto the threads of the eight (8) M6 x 12mm SHCS bolts from the side cover kit and loosely screw on the side cover brackets to the underside of the supercharger lid.

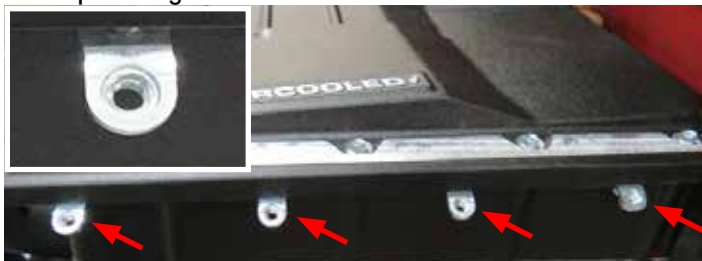

55. For proper bracket alignment, test fit the side covers onto the brackets using eight (8) M6 X 25mm bolts from the side cover kit. While pushing the side covers forward, fully tighten the bracket bolts. Once all brackets are aligned and tightened, remove the side covers.



56. Using O-ring lube, install the fuel caps onto the fuel rails. Attach the supplied fuel crossover to the rear of both rails. Insert the straight fittings into the fuel rails as shown. **NOTE: For cars without Direct Injection, you must block off all ports on the fuel rails except for the driver side barb. Use the supplied -6AN plugs provided in this kit.**



57. Apply O-ring lube to both ends of the fuel injectors (not included), then install them into the supplied fuel rails, oriented so the electrical connectors will face away from the supercharger.

Steps 58 and 59 are for GT350 & 2018+ model years.

58. Remove the factory fuel pressure sensor from the driver side factory fuel rail.



59. Apply fuel resistant thread sealer to the threads of the fuel pressure sensor adapter. Thread the adapter into the supercharger fuel rail until snug. **Ensure not to overtighten and strip threads.** Apply the same thread sealer to the fuel pressure sensor and thread it into the adapter. Prevent the adapter from twisting in further with a second wrench. Optionally continue to twist the sensor once snug until it aligns with fuel rail.



60. Temporally install the fuel rail assembly onto the supercharger manifold.

61. Be sure that the engine bay is clean and free of debris, then remove the masking tape used to protect the intake ports from contamination.

62. With the help of an assistant, carefully lower the supercharger manifold onto the cylinder heads. Be especially careful not to pinch any wires between the supercharger and the cylinder heads. **(RHD vehicles may require additional trimming for supercharger lid clearance).**



63. Mount the fuel rails and move them away from the supercharger to access the supercharger manifold bolts. Secure the supercharger manifold to the cylinder heads using a 10mm swivel socket to install ten (10) M6 x 30mm intake manifold bolts supplied in hardware Bag # 1. Using the torque sequence below, torque the bolts to 8 ft-lbs.

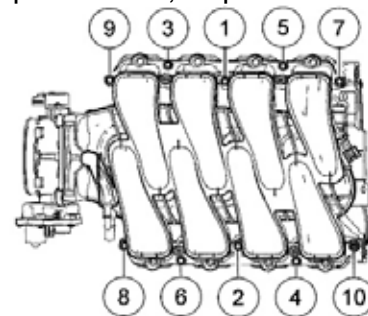

64. Install the fuel rails and secure using four (4) M6 x 16mm bolts from Bag # 1. Bolt holes are located beneath the fuel rail. **Start fuel rail bolts BY HAND first and make sure thread engagement is smooth before tightening with tool.**



65. Reconnect the injector connectors to the appropriate fuel injectors.

Edelbrock Pro-Tuner Supercharger System 2015-19 Ford Mustang 5.0L, 5.2L Installation Instructions

66. For 2018+ models, connect the factory fuel lines to the straight fittings on the driver and passenger side fuel rails. On 2015-17 models, connect the fuel line to the drive side connector located on the fuel rail.



67. Reinstall the passenger side heater hose fitting using the factory hardware.



68. Reconnect the passenger side heater hose.



69. Install the supplied evap hose with 90 degree fitting onto the nose,



Steps 70 to 74 are for 2015-17 models. For 2018+, skip to step 76.

70. Connect the supplied EVAP hose to the nose as shown. The EVAP adapter will be installed later in this installation.



71. Install the EVAP solenoid into the EVAP solenoid adapter as shown below.

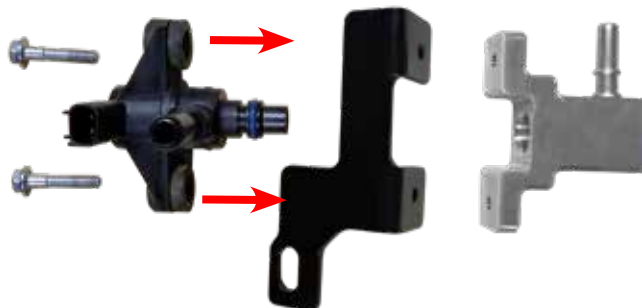

72. Bolt the EVAP adapter bracket to the strut tower using the supplied 10mm nut and bolt.



73. Remove the factory EVAP hose located below the brake booster near the firewall. Replace with the supplied EVAP hose.



74. Attach the new EVAP hose from the firewall to the EVAP solenoid. Then, connect the hose from the EVAP adaptor to the nose as pictured. Plug in the EVAP using the harness from the water pump.



Step 75 is for 2018+ model years only.

75. Remove the evap solenoid from the factory manifold. Install the solenoid onto the bracket using the factory rubber grommet. Connect the hoses. Put the evap in position and leave the bracket loose until the supercharger installation is complete.



76. Use a 3/8" breaker bar to rotate the tensioner clockwise, finish installing the supplied belt according to the routing diagram shown below.

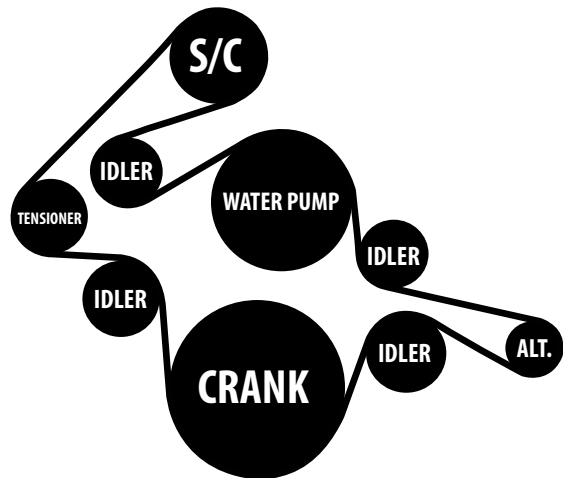

77. Using the two (2) factory bolts, reinstall the coolant reservoir with a 10mm socket.



78. Install the supplied coolant bleed hose and secure with the factory hose clamps.



79. Carefully remove the protective foam from the brake aspirator.



80. Remove the hose that attaches to the check valve and replace with the supplied 3/8" hose. Attach the supplied vacuum cap to the opposite end of the aspirator.

81. Remove the other two hoses from the brake aspirator and attach the Aspirator to Manifold hose and the Aspirator to Elbow hose as shown.



82. Attach the brake booster hose on the aspirator hose assembly to the check valve.



83. Route the Aspirator to Manifold hose under the heater hose and attach to the fitting on the supercharger nose.



84. If equipped, remove the four (4) bolts attaching the shutters to the crash guard and radiator support.

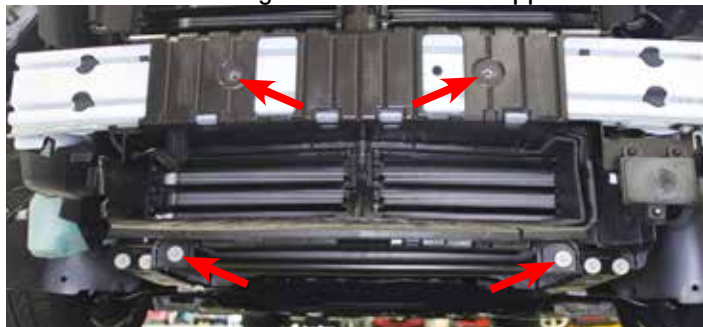

85. Remove the two (2) clips securing the shutter bracket to the core support.

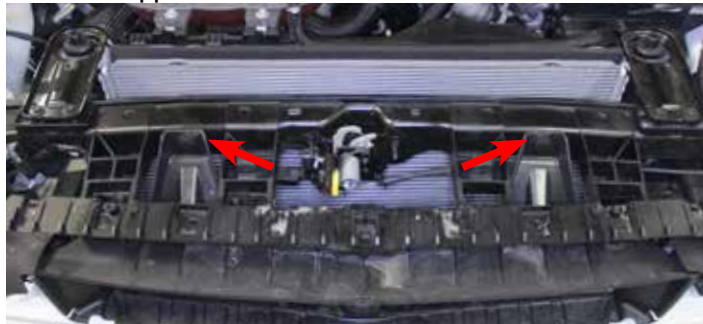

Edelbrock Pro-Tuner Supercharger System 2015-19 Ford Mustang 5.0L, 5.2L Installation Instructions

86. In front of the radiator, undo the lower shutter actuator arm by removing the two (2) bolts pictured. Swing out of the way and pull the shutters out through the front of the vehicle.

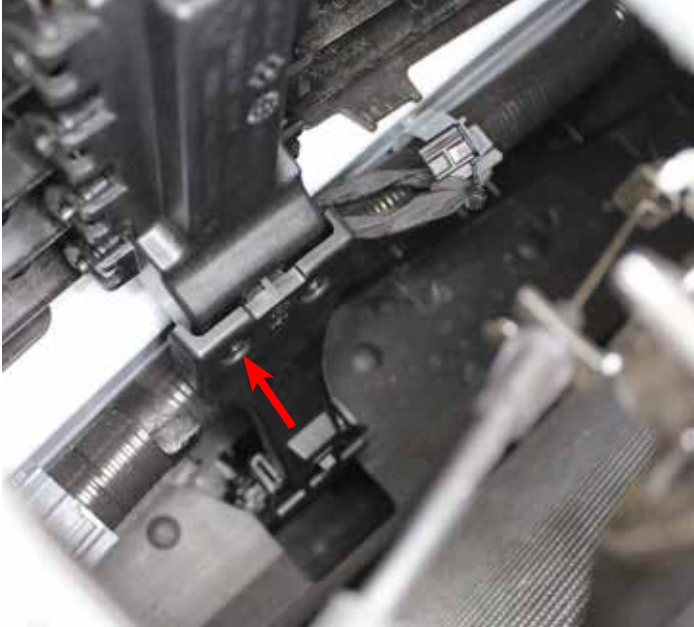

87. Remove the crash beam cross braces, if equipped.



88. Back out the four (4) crash beam bolts (circled in image) but do not remove. Install the LTR brackets from behind the crash beam and onto the crash beam support studs. Line up the holes on the LTR brackets with the studs to temporarily hold the LTR brackets in place. Then install the LTR from below as pictured.



89. Install the supplied cross braces using the two (2) M8 x 30mm hex flange bolts from Bag # 3, loosely screw in the bolts through the crash beam braces. The lower cross braces will sandwich the LTR to the crash beam and be secured using the M8 nuts and washers supplied in Bag # 3. Once all bolts are in place through the braces, fully tighten the bolts and nuts.

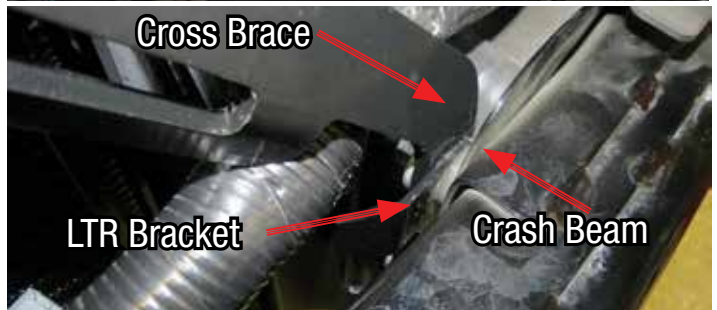
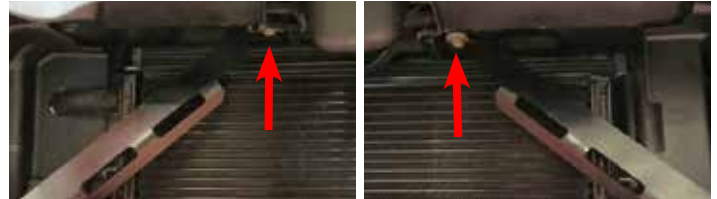

90. Using a drill and a 1 1/4" hole saw bit, drill a hole in the shroud that lines up vertically and parallel with the lower LTR barb.



91. Cut a hole in the shroud that the upper LTR hose can route through. **CAUTION:** Be mindful of the A/C hard lines behind the shroud.



92. Attach the LTR to WP hose to the water pump and secure with a hose clamp from Bag # 3.



93. Feed the hose through the hole in the shroud and secure the water pump to the chassis using the supplied nuts in Bag # 3.



94. Secure the hose to the LTR with a hose clamp from Bag # 3.



95. Insert the LTR to Manifold hose through the hole on the upper shroud and secure to the top LTR bung with a hose clamp from Bag # 3. Secure the other end to the lower bung on the supercharger manifold.



96. Attach the surge tank bracket to the surge tank using two (2) M6 x 10mm bolts from Hardware Bag # 3. Also attach the water pump hose to the surge tank and secure it with a hose clamp from Bag #3.



**Edelbrock Pro-Tuner Supercharger System
2015-19 Ford Mustang 5.0L, 5.2L
Installation Instructions**

97. Connect the Water pump to Surge tank hose to the water pump and secure with a hose clamp from Bag #3.



98. Secure the Surge Tank to Manifold hose to the surge tank and manifold using two (2) hose clamps from Bag # 3.



99. Using a 10mm socket, remove the top bolt securing the windshield wiper fluid reservoir. Place the surge tank bracket onto reservoir and secure the bracket and reservoir using the factory bolt.



100. Using a razor blade, or equivalent, remove the 90° quick connect fitting on the factory passenger side PCV hose.



101. Attach the 90° fitting onto the supplied 1/2" Cadbar hose. Connect the quick connect fitting to the passenger side valve cover and the other end of the hose to the barb on the supercharger nose.



102. Zip tie the Fuse holder on the Water Pump/ EVAP Harness onto the fuse box.



Edelbrock Pro-Tuner Supercharger System 2015-19 Ford Mustang 5.0L, 5.2L Installation Instructions

103. Open the fuse box and using a 10mm socket, attach the “Power Supply Wire” on the Water Pump/EVAP Harness to the power terminal on the fuse box.



104. For 2018-19 models, GT350, cut the green wire on the Water Pump/EVAP harness below the fork in the wires. Splice the green wire to the red wire on the fused lead as pictured here.

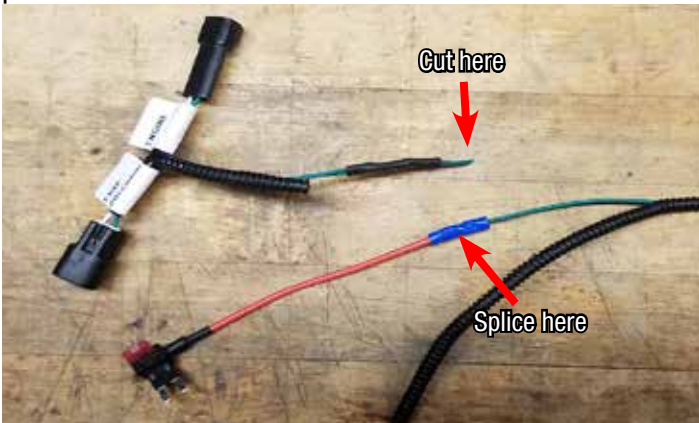

105. For 2018-19 models, GT350, Remove the fuse from socket #62 and plug the fuse bypass lead in the socket. Replace the fuse back into the fused bypass lead.

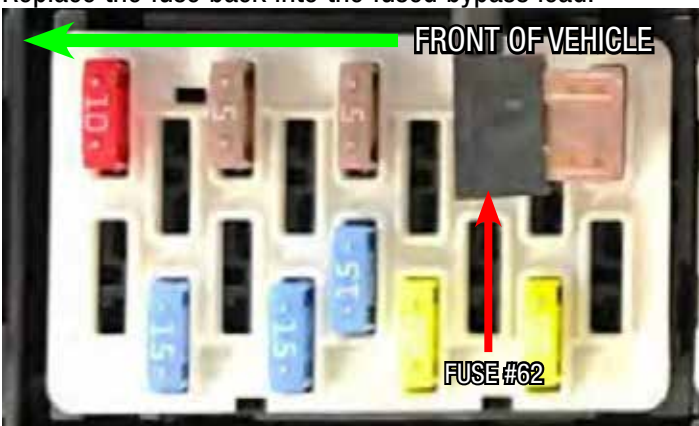

106. Route the “Intercooler Water Pump” end of the Water Pump/EVAP Harness below the fuse box and around the washer fluid reservoir and plug it into the intercooler water pump.

107. Using a 10mm socket, remove the passenger side upper head lamp bolt. Attach the relay and screw the bolt back into the frame. **NOTE: Use a step drill to enlarge the hole on the relay tab until the bolt is able to pass through the hole.**



108. Route the ground strap and water pump connector downward through the frame. Remove the bolt securing the factory ground shown and mount the ground strap along with the factory ground in the original location. Connect the water pump.

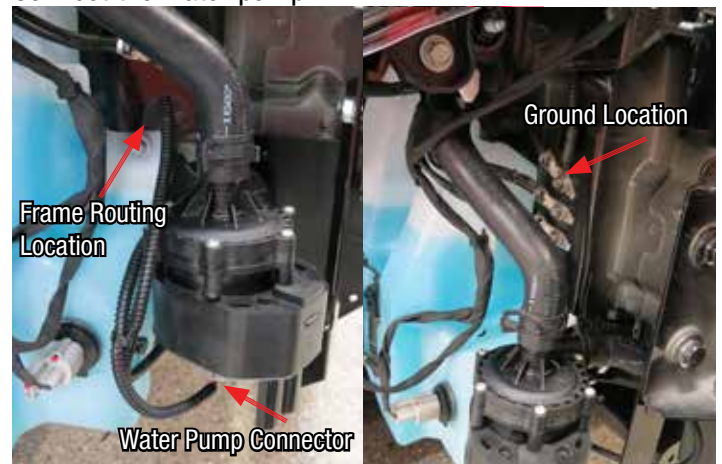

109. **2018+ models**, connect the factory EVAP connector onto the “Engine Harness” end of the “Water Pump/EVAP Harness” and the “EVAP Solenoid” end onto the EVAP solenoid.



110. Using the supplied gaskets and (4) M6x20mm bolts, install the adapter to the supercharger nose as pictured below. Then, attach the throttle body. (Throttle body sold separately) Plug in the factory throttle body cable into the new throttle body.

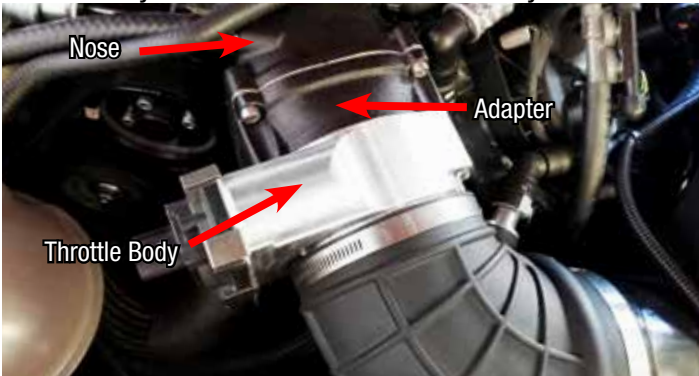

111. Assemble the MAF housing into the new air box using the provided M6 x 12mm bolts located in bag #5.



112. Remove the MAF sensor from the factory air box lid and reinstall into the new MAF housing using the provided pan head screws in bag #5.



113. Remove the rubber mounting grommet from the factory air box and install into the frame of the vehicle.



114. Using the provided worm clamps, secure the silicone intake elbow to new the air box. Then, lower the air box and tube assembly into place and secure with the factory bolt set aside earlier. Tighten the clamp holding the intake elbow to the throttle body. **TIP:** You may need to loosen the MAF housing to install the hose.



Edelbrock Pro-Tuner Supercharger System 2015-19 Ford Mustang 5.0L, 5.2L Installation Instructions

115. Install the conical air filter onto the MAF housing inlet using the provided clamp.



116. Install the air box lid using the six (6) 1/4"-20 cap screws located in bag #5.



117. Connect the brake aspirator to the lower fitting on the silicone elbow.

118. 2018+ Only: Using a razor blade, or equivalent, remove the 90° and 45° quick connect fitting from the factory driver side PCV hose.



119. 2018+ Only: Connect the 90° and 45° fitting to the supplied driver side PCV hose. Connect the hose to the valve cover and the other end to the fitting on the intake elbow.



120. 2015-17 Only: Use the supplied driver side PCV as shown below.



121. Before replacing the shutters, the bottom section will need to be cut and removed to clear the LTR. Trim the shutter bracket as shown in the picture below. Replace the two (2) shutter bracket bolts into the crash guard and the two (2) clips on top that attaches to the core support. **(NOTE:** Rounding the corners isn't necessary but is safer to work with.)

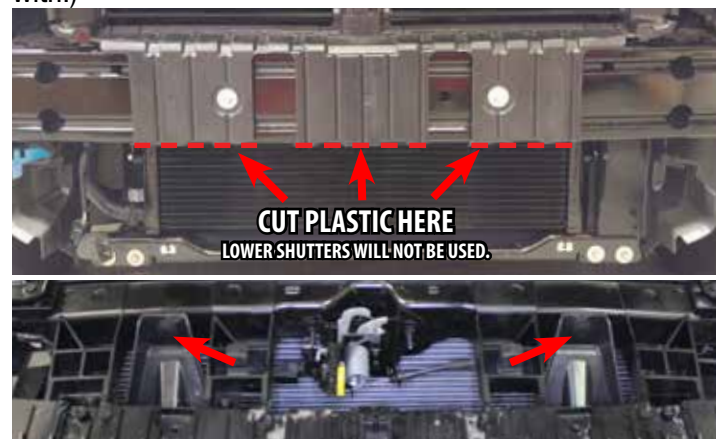

122. Reconnect the fog lights and indicators, then replace the fascia onto the front of the car.



Edelbrock Pro-Tuner Supercharger System 2015-19 Ford Mustang 5.0L, 5.2L Installation Instructions

123. Reattach the lower splash shield and secure it with the stock fasteners.

124. Verify that the coolant petcock is closed, then refill the coolant system. (If necessary.)

125. Fill the supercharger surge tank with a 50/50 coolant and water mixture. **NOTE: Please see "How to Prime the Edelbrock E-Force Intercooler Systems" at the end of these instructions for detailed instructions.**

126. Turn the ignition key to the 'ON' position. Verify that water is flowing briskly through the recovery tank, then install the cap.

Steps 127 to 131 are optional when installing Edelbrock Coil Covers.

127. Once the installation has been verified, Prepare the coil covers for installation. Install the (8) M6 x 8mm decorative bolts onto the covers.

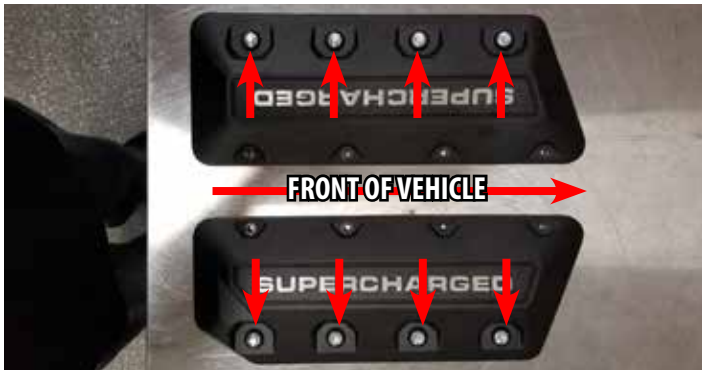

127. As a precaution, slice a 5" length of hose to wrap around the fuel line as pictured. This is to prevent the hose from rubbing on the edge of the coil cover. Secure with zip-ties.



128. Place the EVAP (2018+ models only) in position for the coil covers. **TIP:** Place the bolts through the coil covers first, then feed the bolts into the EVAP bracket. Then thread the bolts into the supercharger coil cover brackets.

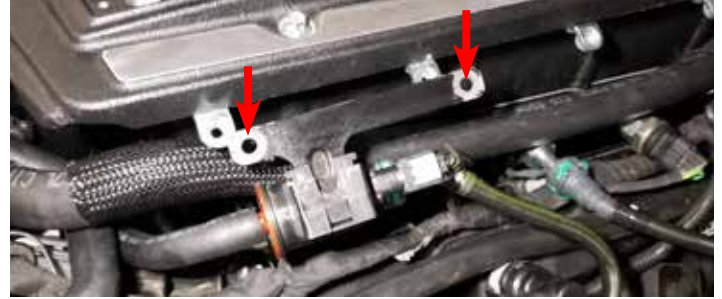

129. Using the eight (8) M6 x 25mm bolts from the side cover kit, secure the side covers to the side cover brackets previously installed.



130. Repeat the same process for the passenger (right) side of the vehicle.



Congratulations on the installation of your new Edelbrock E-Force Supercharger System. If you have any questions, please call our Technical Support hotline and one of our technicians will be happy to assist you.

CAUTION: Check ADAS sensors as described under the "Important Warning" section in the front of this document.

How to Prime the Edelbrock E-Force Intercooler Systems.



The electric water pump used on this Edelbrock E-Force Supercharger System has a built-in micro-processor that will vary pump cycle speed when air bubbles are present in the system. If a significant amount of air is trapped in the system, the pump may cycle at a slower speed and pulsations are likely to occur resulting in poor cooling performance.

For the best result, it is highly recommended to use a Radiator Cooling System Vacuum Purge and Refill Kit to properly evacuate the air from the intercooler system before filling with a 50/50 mixture of coolant and distilled water. If one is not available, the following procedure will be adequate.

1. Using the Lisle 24680 Spill-Free Funnel, or equivalent, secure the appropriate filler neck adapter to the surge tank.
2. Attach the funnel and fill with a 50/50 mixture of coolant and distilled water until the funnel is half full.
3. Turn the ignition to the ON position and listen for the pump's electric motor to cycle. Air bubbles will begin to purge from the system as the coolant level drops. Add coolant to the funnel as necessary. **NOTE: Do NOT let the coolant level in the funnel run empty as this may introduce air into the system.**
4. To build more pressure in the intercooler system, try squeezing the intercooler hoses while the pump is cycling. Building pressure in the system will help purge the trapped air from the intercooler system.
5. Cycle the ignition OFF and wait a few seconds for the pump to come to a stop.
6. Cycle the ignition ON again and repeat until the sound of the electric pump is continuous without any pulsation. **NOTE: During water pump start-up, it is normal for a slight pulsation to occur. Once the pump has reached its maximum cycle speed, no pulsations should be present.**
7. Periodically inspect the water pump flow after a few drive cycles and re-fill the intercooler system as necessary.
8. Several drive cycles may be required to completely purge the air from the intercooler system. During a drive cycle, the intercooler system will build up pressure as the supercharger temperature increases. Any residual air trapped in the system will gradually bleed out of the surge tank as the system reaches a pressure above 5psi.

WARNING: Always avoid removing the surge tank cap when the engine is hot. The hot coolant is under pressure and may spray out causing burns.