



Edelbrock Universal LS Supercharger

Part #1540, 15400, 15410, 15420, 15430, 15440, 15470, 15480, 15490



Edelbrock E-Force Universal Supercharger System for the LS GM Engine

Installation Instructions

INTRODUCTION

Thank you for purchasing the Edelbrock Universal Supercharger System for GM LS Engines. The Edelbrock E-Force Supercharger System for LS Engines utilizes Eaton's new Gen VI TVS Supercharger rotors, featuring a four lobe design with a full 160° of twist for: maximum flow, minimum temperature rise, quiet operation, and the reliability for which Eaton is known. The Edelbrock Supercharger is a complete system that maximizes efficiency and performance by minimizing air restriction into, and out of, the supercharger. This results in maximum airflow, with minimal temperature rise and power consumption. The supercharger housing itself is integrated into the intake manifold for a seamless design with minimal components, eliminating the possibility of vacuum leaks between gasket surfaces. The system also utilizes a front drive, front inlet configuration giving it the shortest, least restrictive inlet path on the market. The supercharger is inverted, expelling the air upward. Air pressure then builds in the plenum, before being drawn down through each of two intercooler cores, oriented horizontally, next to, and below the supercharger outlet. After passing through the intercooler cores, the air travels through the long 12" individual intake runners, which route underneath the supercharger housing to the cylinder head ports, in a horizontal, nested configuration. The upper plenum area is enclosed by a top cover and matching side covers that have been designed to provide an appealing and distinctive under-hood appearance. The Edelbrock supercharger provides amazing performance that is safe to operate on a completely stock engine.

NOTE: This kit is designed around an engine equipped with the following GM Performance Parts: LS engine, LS controller kit and Corvette/Camaro accessory drive. If you intend to use other LS components, please contact Edelbrock tech support for assistance.

TOOLS REQUIRED

- Jack and Jack Stands **OR** Service Lift
- Metric Socket Sets w/1/2", 3/8" & 1/4" Drive Ratchets
- 10mm Swivel Socket, 1/4" Drive
- Complete Set of Metric Wrenches
- Crescent Wrench
- 1/2" Breaker Bar
- Flat Blade & Phillips Screwdrivers
- Compressed Air
- Torx-20 Driver
- Allen Wrenches
- Torque Wrench
- Pliers **OR** Hose Clamp Removal Tool
- Pneumatic or Power Drill
- Impact Wrench
- Red & Blue Loctite or equivalent
- O-ring Lube
- Thread Sealing Compound
- Anti-seize
- Masking Tape
- J-42386-A Flywheel Holding Tool

ANCILLARY PARTS REQUIRED FOR INSTALLATION

- **Low Temperature Radiator**
 - #15405: Full Face Universal Fit
 - #15406: Compact Single
- **Belt:**
 - For GM Performance-Corvette Accessory Drive utilize Goodyear Gatrорback #4061015
 - All other accessory drive configurations will require installer to determine the optimal belt length.
- **Fuel Pump:** As shipped, the kit is approx. 600+ HP, depending on cam and header selection. **A minimum fuel flow of 65gph @ 60psi is required.** It is the responsibility of the customer to ensure that adequate fuel flow is achieved at the operating voltage of the fuel pump. Engine damage can occur if fuel flow is insufficient. Below is a list of potential fuel pumps.
 - #1790 or - #1794
 - Or a custom set up, such as: dual 255 l/hr in-tank pumps
- **Fuel Pressure Regulator w/ Boost Reference**



Edelbrock E-Force Universal Supercharger System for the LS GM Engine

Installation Instructions

IMPORTANT WARNINGS

Before beginning installation, use the enclosed checklist to verify that all components are present in the box then inspect each component for damage that may have occurred in transit.



WARNING: Installation of this supercharger will result in a significant change to the performance characteristics of your vehicle. It is highly recommended that you take some time to familiarize yourself with the added power, and how it is delivered, in a controlled environment. Take extra care on wet and slippery roads, as the rear tires will be more likely to lose traction, with the added power. It is never recommended to turn off your vehicles traction control system.

Proper installation is the responsibility of the installer. Improper installation will void all manufacturer's standard warranties and may result in poor performance and engine or vehicle damage.

Due to the complexity of the Edelbrock E-Force Supercharging system, it is recommended that this system only be installed by a qualified professional with access to a service lift, pneumatic tools, and a strong familiarity with automotive service procedures.

Any previously installed aftermarket tuning equipment must be removed and the vehicle returned to an as stock condition before installing the supercharger.

Any equipment that directly modifies the fuel mixture or ignition timing of the engine can cause severe engine damage if used in conjunction with the Edelbrock E-Force Supercharger System. This includes, but is not limited to: ignition boxes, air/fuel controllers, OBDII programmers, and any other device that modifies signals to and/or from the ECU. Aftermarket bolt-on equipment such as underdrive pulleys will also conflict with the operation of the supercharger and must be removed prior to installation. Use of any of these products with the E-Force Supercharger could result in severe engine damage.

MINIMUM OCTANE RATING
(R + M) / 2 METHOD

91

91 octane or higher gasoline is required at all times. If your vehicle has been filled with anything less, it must be run until almost dry and refilled with 91 or higher octane gasoline twice prior to installation.

Failure to use the required 91 octane gasoline or higher could permanently damage your engine. Any failures associated with not using premium 91 octane gasoline or higher, will be ineligible for warranty repairs.

Edelbrock periodically releases improved versions of the calibration file found on the supplied handheld programmer. Check the website to ensure you have the latest version, as described in the Test flash procedure in Step #81.



Edelbrock E-Force Universal Supercharger System for the LS GM Engine

Installation Instructions

INSTALLATION HARDWARE IDENTIFICATION GUIDE

Bag #1



(3x) - M8 x 1.25 x 90mm
Hex Flange Bolt



(1x) - M10 x 1.5 x 75mm
Hex Flange Bolt



(2x) - M10 x 1.5 x 65mm
Hex Flange Bolt



(3x) - M8 x 1.25 x 100mm
Socket Head Bolt



(1x) - M10 x 1.5 x 65mm
Socket Head Bolt



(1x) - M10 x 1.5 x 60mm
Socket Head Bolt



(1x) - M10 x 1.5 x 45mm
Socket Head Bolt



(3x) - M8 x 1.25 x 20mm
Hex Flange Bolt



(2x) - M8 Washer

Bag #2



(1x) - 10mm Quick Disconnect to
Barb Fitting



(8x) - 3/4"
Hose Clamp



(2x) - 1/2"
Hose Clamp



(1x) - 3/8" ID X 7/8" OD
Rubber Grommet



(1x) - M8 x 1.25 x 30mm
Hex Flange Bolt



(4x) - M6 x 1 x 16mm
Hex Flange Bolt



(3x) - M6 x 1 x 12mm
Hex Flange Bolt



(2x) - #8-16 X 3/8"
Thread Forming
Screw



Edelbrock E-Force Universal Supercharger System for the LS GM Engine

Installation Instructions

Bag #3



(11x) - M8 x 1.25 x 25mm
Countersunk Socket Head Bolt



(8x) - M6 x 1 x 45mm
Hex Flange Bolt



(4x) - M6 x 1 x 12mm
Socket Head Bolt



(2x) - M6 x 1 x 16mm
Button Head Bolt

Bag #4

(1x) - GM Factory Harmonic Balancer Bolt



(1x) - M16 x 2 x 120mm Hex Bolt



(1x) - Crank Pinning Drill Guide



(1x) - 1/4" x 3/4" Steel Dowel



(1x) - 15/64" High Speed Steel Drill Bit



(1x) - .2500" Reamer



Edelbrock E-Force Universal Supercharger System for the LS GM Engine

Installation Instructions

Bag #5 - Not Included in 15430 and 15480 Kits

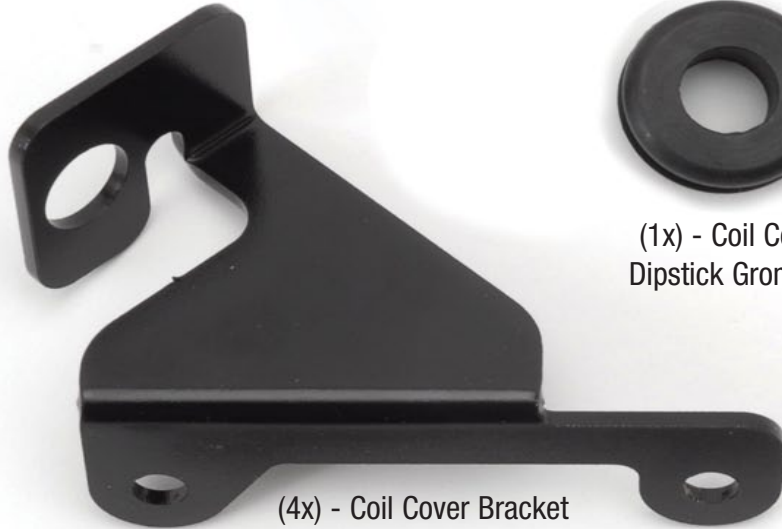

(4x) - Coil Cover Bracket



(1x) - Coil Cover Dipstick Grommet



(4x) - Coil Cover Bracket Grommet

(4x) - Coil Cover Retainer Stud



(4x) - Coil Cover Standoff



FEAD Hardware Bag #1- #15430 and 15480 Kits Only



(2x) - M10 x 1.50 x 90mm Hex Flange Bolt

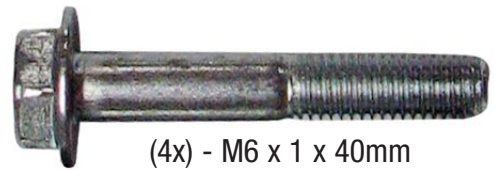

(4x) - M6 x 1 x 40mm Hex Flange Bolt



(1x) - M8 x 1.25 x 20mm Hex Flange Bolt



(1x) - Rubber Grommet



(1x) - M8 Washer



(2x) - Bushings



Edelbrock E-Force Universal Supercharger System for the LS GM Engine

Installation Instructions

WIRE HARNESS IDENTIFICATION GUIDE

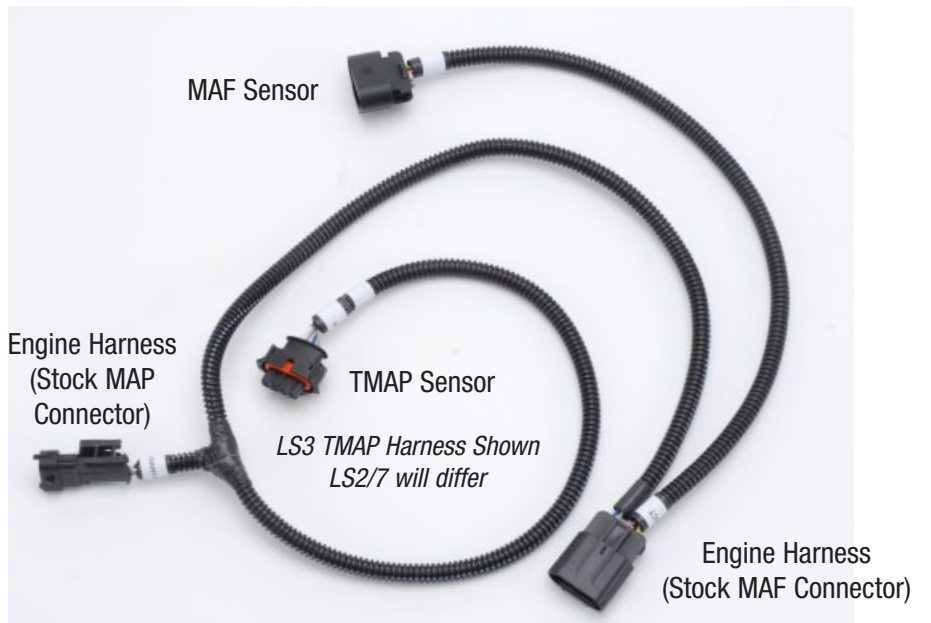
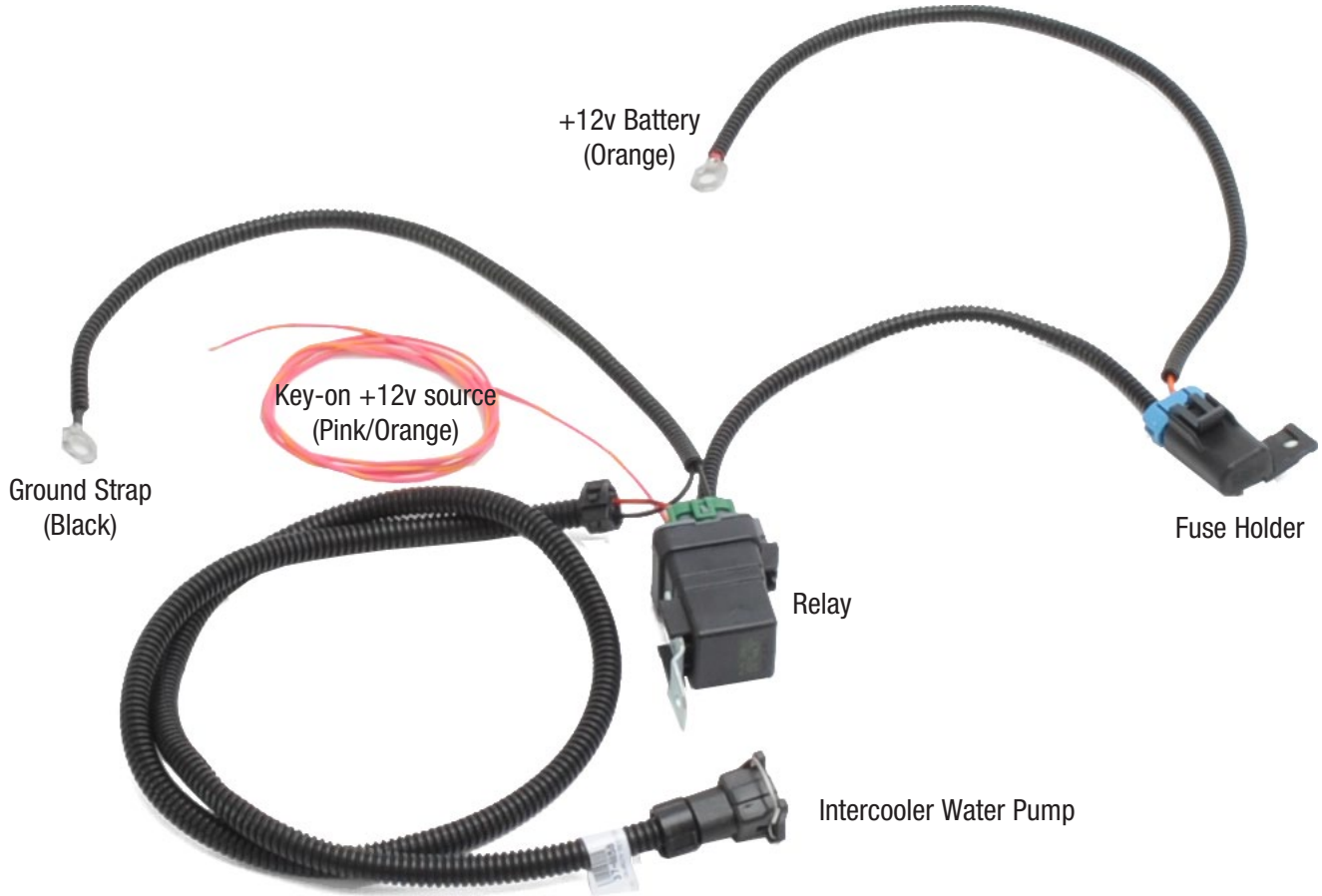



Edelbrock E-Force Universal Supercharger System for the LS GM Engine

Installation Instructions

HOSE IDENTIFICATION GUIDE





Edelbrock E-Force Universal Supercharger System for the LS GM Engine

Installation Instructions

INTERCOOLER PLUMBING DIAGRAM

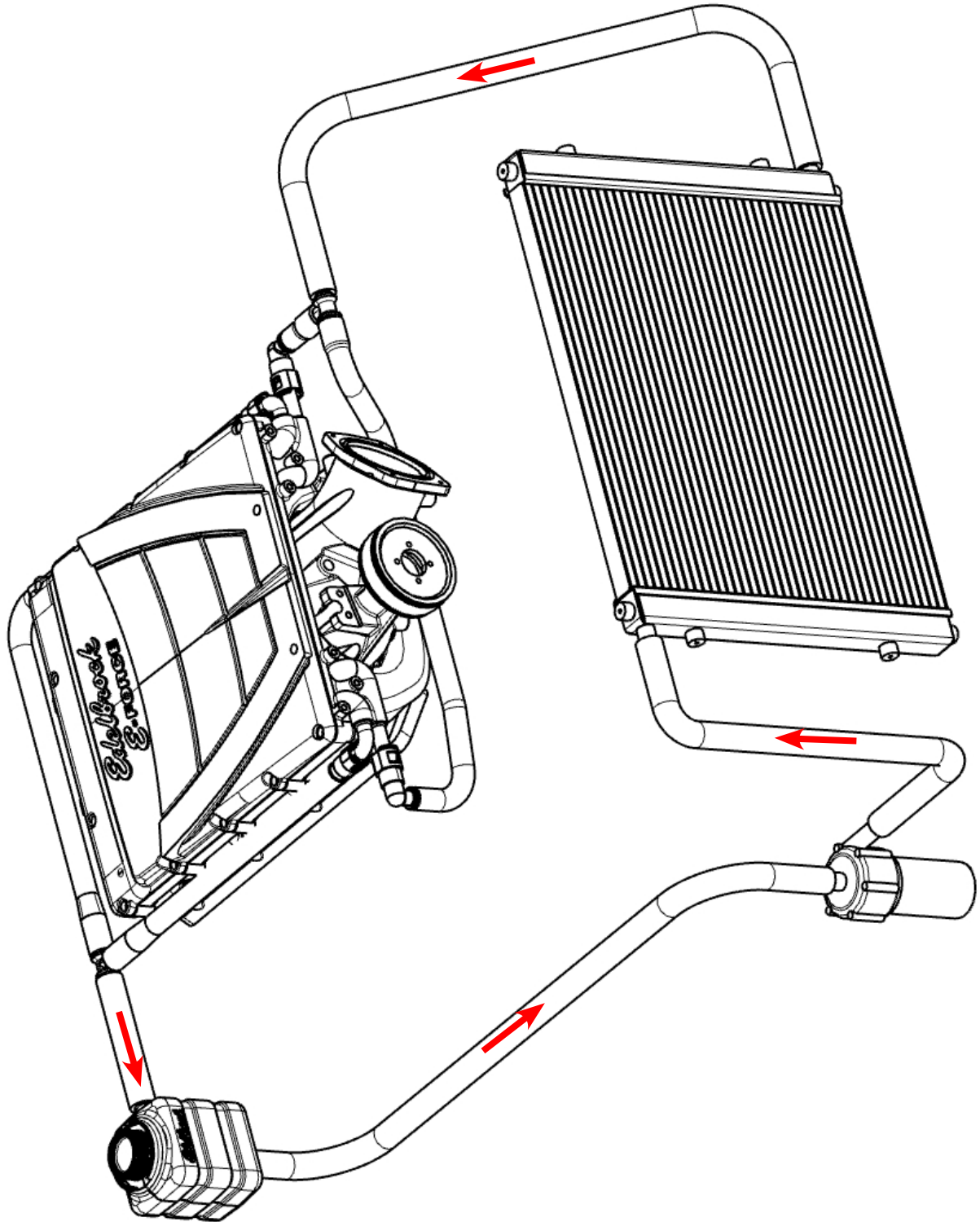



Edelbrock E-Force Universal Supercharger System for the LS GM Engine

Installation Instructions

Test Flash Procedure *(Applicable for P/N 1540 Only)*

Use the supplied programmer to flash the ECU and verify its compatibility.

Original Equipment Manufacturers often release updates to the computer programming for your vehicle. Edelbrock highly recommends that you verify, with your new car dealer, that your vehicle is equipped with the latest software version from your vehicle manufacturer, before attempting to load the Edelbrock tune.”

- Confirm that you have the latest calibration by checking the Edelbrock website and entering your serial number in the search field. (Your 4 digit supercharger serial number is written on your kit checklist paperwork, and is also stamped on the front bolt bosses of your supercharger—first 2 digits on RH bolt boss, 2nd 2 digits on LH bolt boss.) Once you have found the latest tune on the site, power on the programmer, press the left arrow and select the Device Info option. Scroll down to Tune Version and compare that number to the one on the site. If they are different, download the new calibration as instructed on the website.
- Put the car into Acc mode, but don't start the vehicle.
- Connect the supplied PCM cable to the OBD-II connector.
- Use directional pad to highlight Program Vehicle option and press Select button.
- Use directional pad to highlight Pre-programmed Tune option and press Select button.
- Read disclaimer then press Select to continue.
- Verify ignition is in the 'Key On' position but that the engine is not running then press Select.
- Use directional pad to highlight your vehicle and transmission combination then press Select.
- Use directional pad to highlight Begin Program then press Select.

- Depending on your specific drivetrain configuration, several separate operations may take place during this step. Completion of each operation will cause the progress bar to reset to zero.

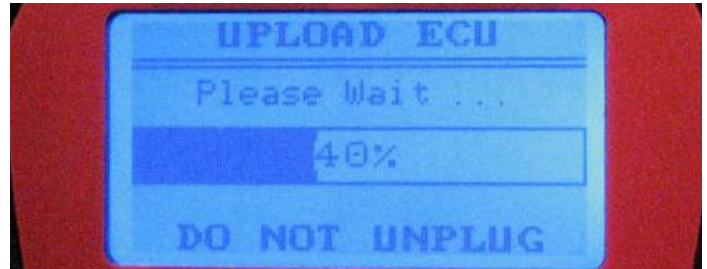

DO NOT unplug the programmer until prompted.

- Turn the car off when prompted to do so by the handheld programmer.
- Read parting message from programmer then press Select to continue.
- Unplug the programmer cable from the OBD-II port.

In the rare occurrence that you encounter an error message during the test flash procedure, please refer to pg. 20, titled E-mail Edelbrock Your Stock PCM Calibration.

Post Successful Test Flash

If you are ready to install the supercharger, proceed to Step 1 of the Supercharger Installation

OR

If you wish to return the ECU back to the factory calibration, such that the vehicle can still be driven until you are ready to begin the installation, then:

- Put the car into Acc mode, but don't start the vehicle.
- Connect the supplied PCM cable to the OBD-II connector.
- Use directional pad to highlight Program Vehicle option and press Select button.
- Use directional pad to highlight Return To Stock option and press Select button.
- Follow the on screen instructions.
- Turn the car off when prompted to do so by the handheld programmer.



Edelbrock E-Force Universal Supercharger System for the LS GM Engine

Installation Instructions

- Read parting message from programmer then press Select to continue.
- Unplug the programmer cable from the OBD-II port.
- When you are ready to Install the supercharger, proceed with Step 1 and you will be prompted to re-flash the ECU towards the end of the installation procedure.

Supercharger Installation

1. Disconnect the battery.
2. Disconnect all hoses from the intake manifold. This includes the brake booster, PCV and EVAP hoses (if equipped). Disconnect the fuel input line and eight fuel injector connectors. The fuel rails and injectors will be removed with the manifold.
3. Unbolt and remove the intake manifold. Then use masking tape to cover the exposed intake ports on the cylinder heads. Save the intake gaskets, throttle body and throttle body gasket.
4. Disconnect the ignition coil harness (blue) and O2 sensor connectors then disconnect the spark plug wires (red) from the ignition coils.
5. Use a 10mm socket to remove the five retaining bolts (green) from the coil bracket on each valve cover, then remove both coil bracket assemblies.

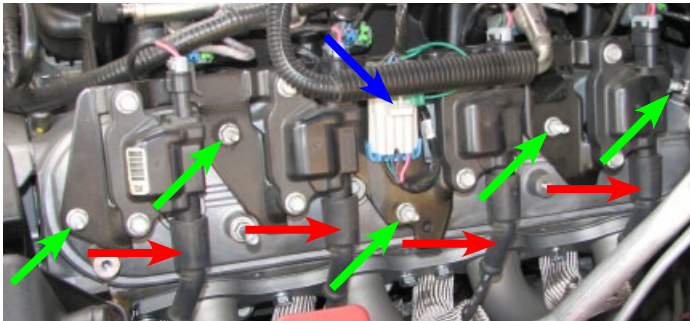

6. Engines using the Corvette or CTS-V front accessory drive setup will need to remove the power steering reservoir and determine an alternate mounting location due to interference with the supercharger snout. Inspect the engine bay for any other items that may interfere with the installation of the supercharger.

NOTE: The following steps, while not strictly related to installing the supercharger, detail the process required for installing a lock pin between the harmonic balancer and the crankshaft nose. The factory design uses a press-on balancer that does not include an anti-rotation mechanism to prevent the balancer from loosening. The additional torque of the E-Force system increases the likelihood of this occurring. If you have already had this procedure performed on your vehicle, skip ahead to step #30.

NOTE: Vehicles equipped with a manual transmission may skip Steps: 7-14 and 24-29 by using an assistant to manually secure the drivetrain while the harmonic balance bolt is removed. Begin by placing a passenger in the car to shift into first gear and firmly apply the brake at which point, you may begin removing the bolt.

WARNING: Do not attempt this method if the rear wheels are on the ground as vehicle damage and/or injury could result.

7. Disconnect the oil level sensor electrical connector from the passenger side of the oil pan.



8. Use a 10mm socket to remove the starter support bracket bolt.

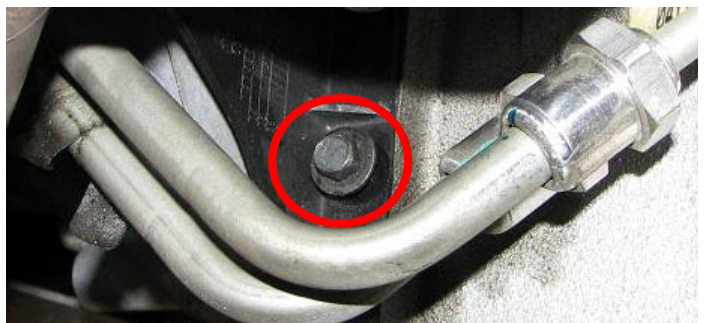



Edelbrock E-Force Universal Supercharger System for the LS GM Engine

Installation Instructions

9. Use a 13mm socket to remove the two starter bolts.

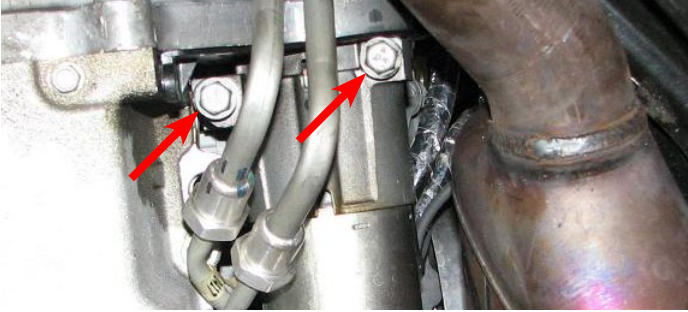

10. Use an 8mm wrench to remove the three bolts retaining the starter heat shield.

11. Disconnect electrical connector at top of starter.

12. Use a 13mm socket to remove the nuts retaining power wires to the starter.



13. Remove the starter and bracket.

14. Install a GM Flywheel Holding Tool (#J-42386-A), or equivalent, to prevent the crank from rotating while loosening the balancer bolt. Torque the flywheel holding tool bolts to 37 ft/lbs.

15. Use a breaker bar and a 24mm socket to loosen and remove the crank bolt. **NOTE:** A long pipe slid over the breaker bar can be helpful for increasing leverage.

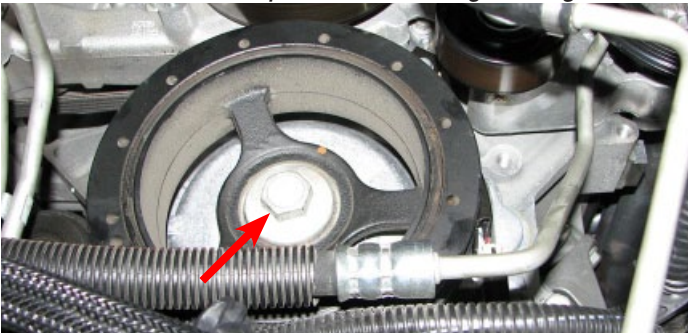

16. Install the drill guide and the M16 x 120mm guide bolt supplied in Bag #4 onto the end of the crankshaft.



17. Measure 1.7" from the tip of the 15/64" drill bit supplied in Bag #4 and mark the position with a piece of masking tape. Drill into the crank through the hole in the guide that has a bushing in it, stop when the tape mark reaches the drill guide.

18. Loosen the guide bolt and rotate the drill guide until the second hole lines up with the hole drilled in the crank. Use the back side of the ream tool to verify the guide is correctly aligned.

19. Tighten the guide bolt then use compressed air to clean out any metal flakes in the drill hole.

20. Insert the supplied ream tool through the hole and ream the full depth of the hole.

21. Use compressed air to clean out any metal flakes then loosen the guide bolt and remove the drill guide.

22. Apply green 609 Loctite (*red Loctite will suffice if green Loctite is not readily available*) retaining compound to the supplied crank pin and tap it into the reamed hole until it is flush with the crank snout.





Edelbrock E-Force Universal Supercharger System for the LS GM Engine

Installation Instructions

23. Install the crank bolt supplied in Bag #4 and torque it to 37 ft-lbs then rotate it an additional 140°.

24. Remove GM Flywheel Holding Tool #J-42386-A.

25. Lift the starter support bracket and starter into place then use a 13mm wrench to reinstall the power wire onto the starter.

26. Reconnect the starter solenoid electrical connector.

27. Use an 8mm wrench to reinstall the three bolts that hold the starter heat shield in place.

28. Use a 13mm socket to install the two starter bolts.

29. Use a 10mm socket to reinstall the starter support bracket bolt.

This concludes the crank pinning procedure.

NOTE: Vehicles with Active Fuel Management (AFM) need to contact Edelbrock's Tech Hotline as the valley tray supplied in these kits will not support AFM equipped engines. Valley trays with AFM will have solenoids attached to the underside of the valley tray as well as an additional connector on the rear of the valley tray.

30. Disconnect the oil pressure sensor electrical connector at the rear of the valley plate.

31. Use a 27mm wrench to remove the oil pressure sensor from the rear of the valley plate.

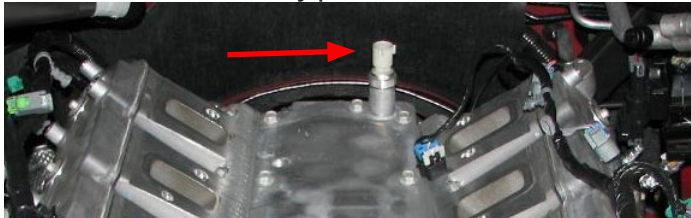

32. Clear the engine valley of all debris, remove the 11 bolts with a 13mm socket, then remove the valley tray.

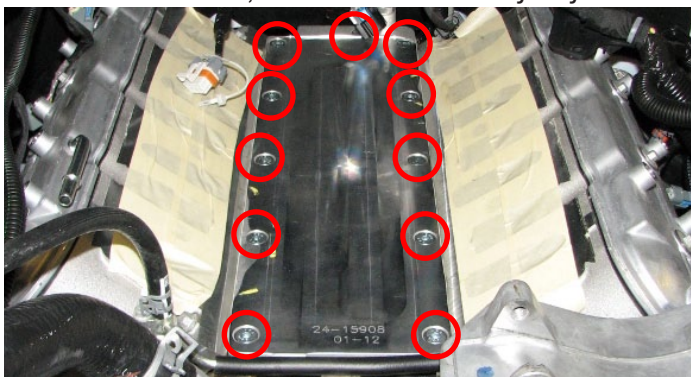

33. Use a small flathead screwdriver to remove the eight O-rings from the stock valley plate and install them in the new valley plate. The oil baffle is not used.



34. Apply anti-seize to the tapered surface beneath the heads of the countersunk bolts supplied in Bag #3. Install the bolts, along with the valley plate and the stock perimeter gasket. Use a 5mm hex socket tighten the bolts from the center out and in a criss cross pattern to 18 ft-lbs.

35. Install the oil pressure sensor into the supplied valley plate with thread sealant and a 27mm wrench. Torque the sensor to 15 ft-lbs.

36. Reconnect the oil pressure sensor electrical connector at the rear of the valley plate.

37. Since two of the stock manifold bolt hole provisions in the cylinder heads break into the crankcase and are not used with this supercharger, install the two button head bolts supplied in Bag #3 in the front passenger side and rear driver side bolt holes to ensure a good seal.

38. Install the stock O-ring port gaskets in the supercharger manifold.



39. Clear the engine valley of any hoses, wires, tools, etc. and remove the tape covering the intake ports. With the assistance of one or more people, lift the supercharger assembly onto the engine.



Edelbrock E-Force Universal Supercharger System for the LS GM Engine

Installation Instructions

40. Use a 10mm socket to install eight M6 x 45mm intake manifold bolts from bag #3 following the torque sequence below. Torque the bolts to 4 ft-lbs in the first pass, then to 7.5 ft-lbs in the second.

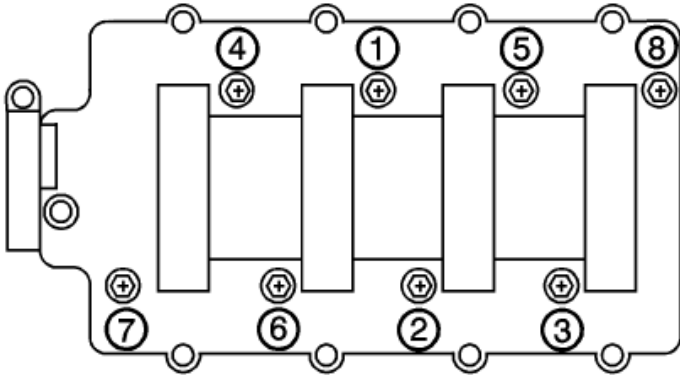

41. Apply O-ring lube to the sealing O-ring of the four supplied fuel rail fittings. Use a 3/4" wrench to install the two plugs on the radiator side of each fuel rail then install the -6 AN fittings in the firewall end of both rails.

42. Take the fuel injectors out of their boxes and remove their protective covers.

43. Apply O-ring lube to the upper injector seals, then slide the injectors into the rails so that the electrical connectors face away from the mounting flange.

44. Apply O-ring lube to the lower seals of each of the fuel injectors.

45. Install the fuel rails by sliding the injectors down into the manifold provisions and applying pressure until the mounting holes in the rails line up with the manifold.

46. Use a 5mm Allen tool to install four 12mm fuel rail bolts supplied in Bag # 3 and torque them to 91 in-lbs.

47. Connect your fuel supply inlet/ crossover hose to the two rear fuel rail fitting. Then connect the fuel input hose (Customer must supply) to the fitting on the crossover.

48. Install the supplied injector wire adapters to each injector and connect to the factory injector connectors.

49. Use a small flathead screwdriver to remove the wire covers at the back of the coil brackets. Note that you will need to separate the covers from the bracket, then split the two halves of the cover.



50. Tuck any loose wiring under each coil bracket then use a 10mm socket and the ten stock bolts to install the coil brackets on to each valve cover.

WARNING: Be careful not to pinch any wires.

51. Reconnect the ignition coil harness electrical connectors and the spark plug wires to the ignition coils.

52. Attach the brake booster hose to the 1/2" fitting on the drivers side of the supercharger inlet, then route it along the driver side valve cover to the fitting on the brake booster. Trim the hose to length, as needed.

NOTE: Steps 53-61 are for vehicles with Corvette Belt Offsets using P/Ns 1540, 15440, 15490. Disregard otherwise.

53. Use a 15mm socket to remove the two bolts retaining the stock belt tensioner.

54. Apply blue loctite to the threads of one M8 X 20mm bolt supplied in Bag #1, then use a 12mm socket and a supplied washer to mount the pulley on the new lower idler bracket and torque it to 18 ft-lbs.

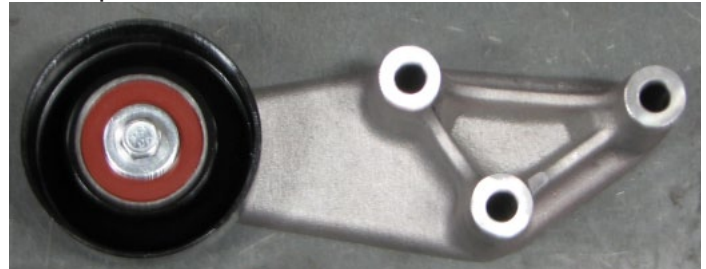



Edelbrock E-Force Universal Supercharger System for the LS GM Engine

Installation Instructions

55. Use a 10mm socket to remove the three bolts on the passenger side of the water pump.

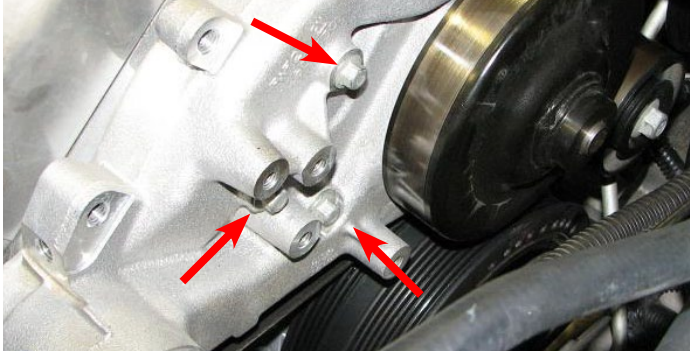

56. Using a 6mm Allen tool and the three 90mm bolts supplied in Bag #1, install the lower idler bracket onto the water pump then torque them to 18 ft-lbs.



57. Apply blue Loctite to two stock tensioner bolts which were removed during Step 53. Mount the new tensioner bracket onto the water pump using the stock bolts and a 15mm socket. Apply blue Loctite to the M10 X 45mm bolt supplied in Bag #1 and install the bolt to the left provision on the bracket. Torque all three bolts to 37 ft-lbs.

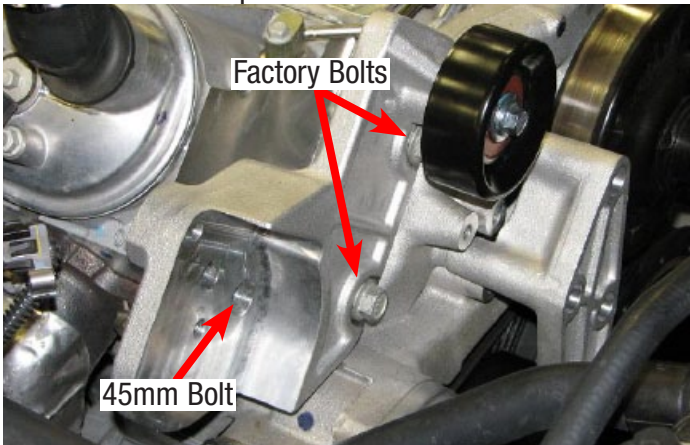

58. Apply blue loctite to the threads of one M8 X 20mm bolt supplied in Bag #1, then use a 12mm socket and the supplied washer to mount the pulley on the tensioner bracket and torque it to 18 ft-lbs.

59. Use a 15mm socket and the 75mm bolt supplied in Bag #1 to install supplied tensioner on new bracket and torque it to 37 ft-lbs.



60. Route the serpentine belt (*not included*) according to the diagram below. Note that you must slide the belt around the bottom of the bracket to get the belt on the lower passenger side idler pulley.

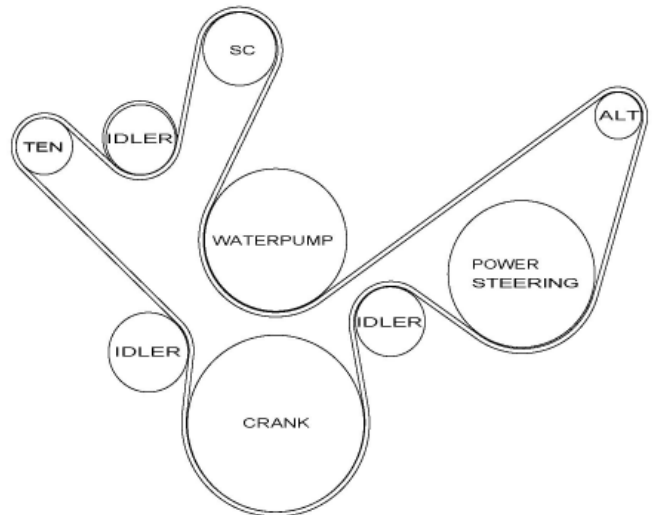

61. Use a breaker bar and a 16mm socket to push the tensioner enough to get the belt on. Double check the routing and make sure the belt is seated properly. Proceed to Step 78.



Edelbrock E-Force Universal Supercharger System for the LS GM Engine

Installation Instructions

NOTE: Steps 62-73 are for vehicles with Camaro Belt Offsets using P/Ns 15410, 15420, 15470. Disregard otherwise.

62. Use a 15mm socket to remove the two bolts retaining the belt tensioner.

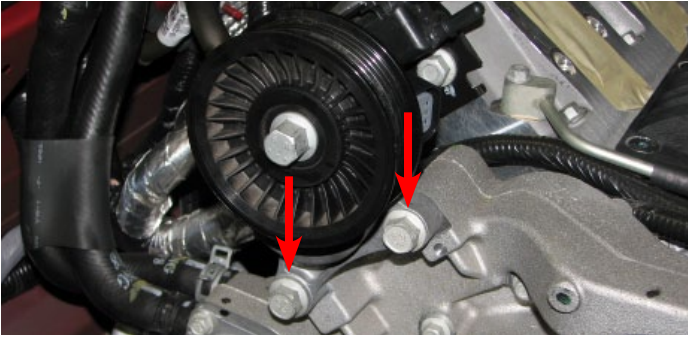

63. Apply blue Loctite to the threads of the M8 x 20mm bolt supplied in Bag #1. Then use a 12mm socket and washer to install the smaller supplied idler pulley onto the supplied idler bracket.



64. Use a 10mm socket to remove the three water pump bolts indicated.

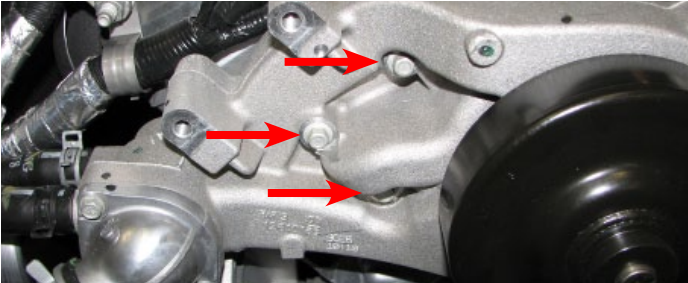

65. Apply blue Loctite to the threads of the M8 x 100mm bolts supplied in Bag #1 then use a 6mm Allen tool to install the idler bracket onto the water pump.



66. Use a 15mm socket to remove the nut retaining the ground strap on the passenger side cylinder head then use a 15mm deep socket to remove the ground strap stud.



NOTE: Step 67 is for IV Gen Camaros only. Disregard otherwise.

67. **Gen IV Camaro Only** - Install the supplied tensioner bracket to the water pump using the spacers from the FEAD kit, three 65mm bolts from bag #1, and blue Loctite. The two short spacers go onto the two provisions on the water pump with two 65mm hex flange bolts, and the long spacer goes on the cylinder head provision with the 65mm socket head bolt.

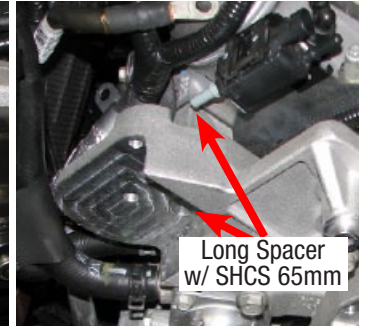
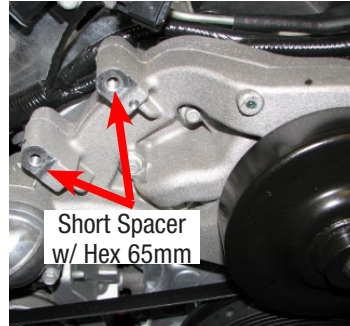

NOTE: Step 68-69 is for V Gen Camaros only. Disregard otherwise.

68. **Gen V Camaro Only** - Apply blue Loctite to the threads of the stock tensioner bolts then use a 15mm socket to install the supplied tensioner bracket to the water pump.

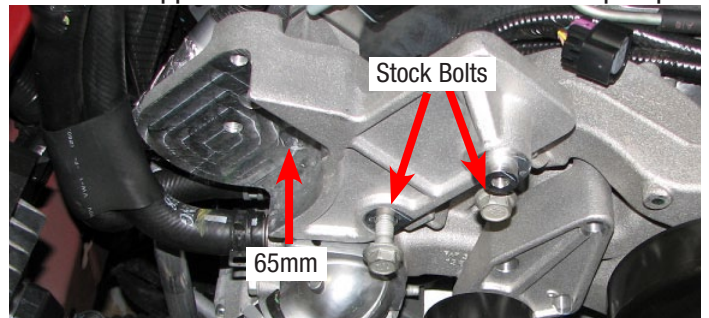

69. Apply blue Loctite to the threads of the M10 x 65mm socket head bolt supplied in Bag #1 then use an 8mm allen to install it in the left bolt hole provision of the tensioner bracket.



Edelbrock E-Force Universal Supercharger System for the LS GM Engine

Installation Instructions

70. Apply blue Loctite to the threads of an M8 x 20mm bolt supplied in Bag #1 then use the supplied washer and a 12mm socket to install the supplied idler pulley onto the tensioner bracket.



71. Apply blue Loctite to the threads of the M10 x 75mm Hex flange bolt supplied in Bag #1. Use a 15mm socket to install the supplied tensioner onto the tensioner bracket.

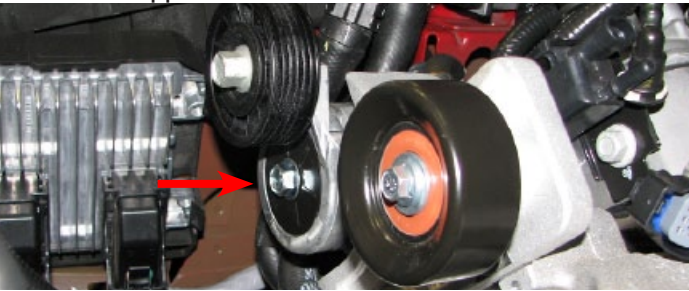

72. Use a 12mm socket and an M8 x 20mm bolt supplied in Bag #1 to secure the ground strap to the back side of the tensioner bracket.

73. Route the serpentine belt (*not included*) according to the diagram below. Use a 16mm wrench to push the tensioner in enough to install the belt. Inspect the belt installation to make sure it is properly aligned. Proceed to Step 78.

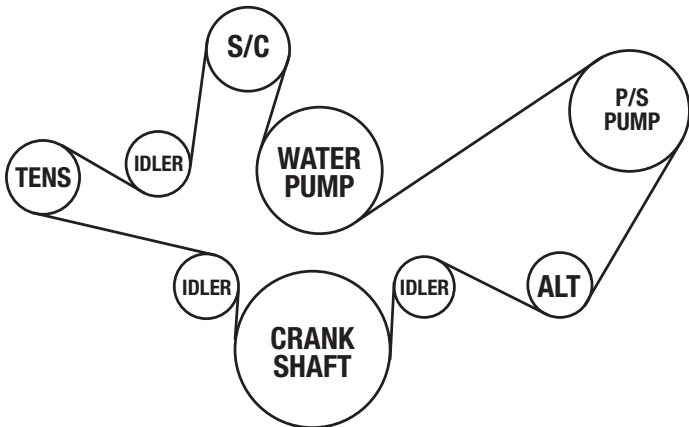

NOTE: Steps 74-77 are for vehicles with Truck Belt Offsets using P/Ns 1540, 15440, 15490. Disregard otherwise.

74. Install the supplied rubber grommet into the hole located in the upper cavity of the alternator bracket. Using a 15mm socket, install the alternator bracket with the factory alternator bolts. Route the actuator hose through the grommet as shown, and re-connect to the actuator.

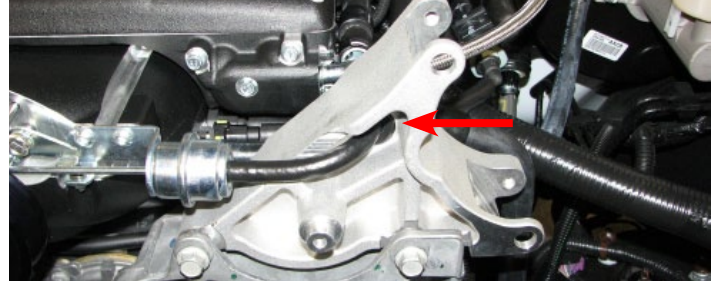

75. Remove the bolt, washer and bushing from the stock 90mm pulley and install them on the supplied 76mm pulley.

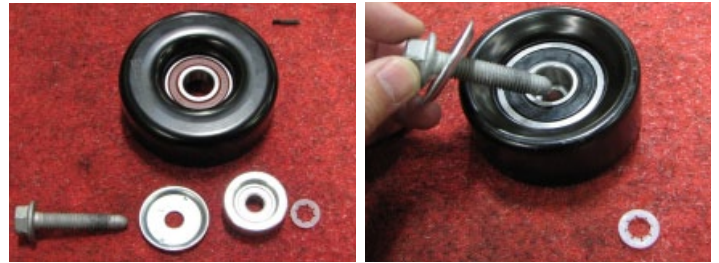

76. Apply Loctite to the threads on both idler pulley bolts. Then use a 15mm socket to install the 76mm idler pulley with the factory hardware to the left idler pulley location. Install the additional idler pulley to the right idler pulley location with the M8 x 20mm bolt and M8 washer from Bag #1. Verify that both pulleys spin freely.

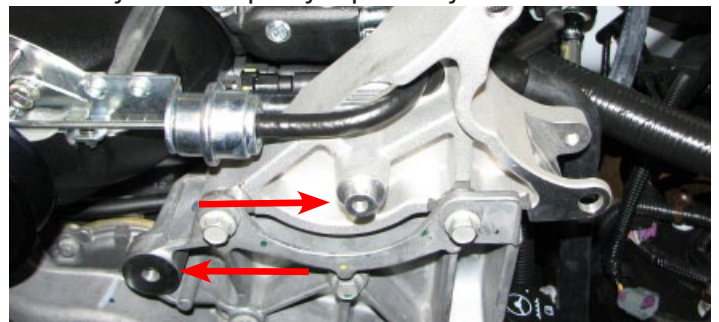



Edelbrock E-Force Universal Supercharger System for the LS GM Engine

Installation Instructions

77. Route the serpentine belt (*not included*) using the diagram below. Use a 15mm socket to release tension from the tensioner and re-tension after the belt is routed. Proceed to Step 78.

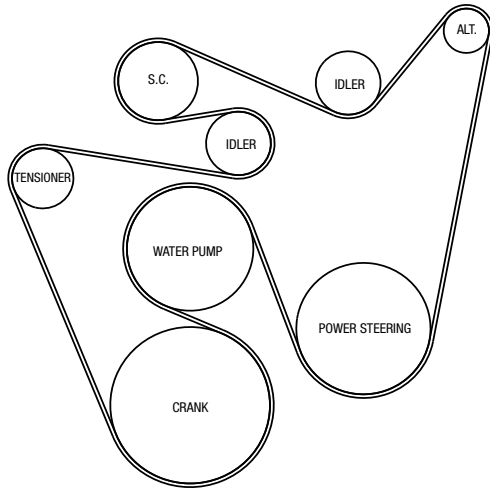

Intercooler and Water pump Mounting

78. Determine the best mounting location for the intercooler heat exchanger. It is important that the heat exchanger receives the coldest air possible, which means mounting it in front of the radiator, A/C condenser and any oil or trans cooler the vehicle might have equipped.

79. Determine the best mounting location for the water pump. A universal mounting bracket has been supplied to simplify installation. Please note that the pump should be mounted no higher than the inlet of the heat exchanger. The inlet of the pump is in line with the axis of the pump motor, while the outlet extends out perpendicularly from the pump body.

80. Determine the best mounting location for the intercooler reservoir. To simplify installation, a universal mounting bracket and a groove around the perimeter of the tank, for use with a large worm clamp, have been included.

NOTE: *Be sure to mount the tank as high as possible to prevent air bubbles from accumulating in the cooling system.*

81. Refer to the diagram on page 8 for the suggested intercooler plumbing. Note that the routing can also be inverted so that the pump and tank are mounted on the driver side. Regardless of component mounting locations, it is important that the correct direction of flow is maintained. The correct order, starting with the intercooler reservoir tank, is to have water flow as follows:

From the bottom fitting of the tank to the water pump inlet; from the water pump outlet to the top of the heat exchanger; from the bottom of the heat exchanger to the intercooler inlet hose assembly; from the intercooler outlet hose assembly to the upper reservoir tank fitting.

82. The intercooler inlet and outlet hose assemblies have been designed so that they will only attach to their correct corresponding fittings on the supercharger. The outlet hose assembly attaches to the upper-rear facing fittings, while the inlet hose assembly attaches to the lower, outward facing fittings.

83. Bulk 3/4" hose has been supplied to plumb the gap from the reservoir tank to the pump, the pump to the heat exchanger, the heat exchanger to the inlet hose assembly and the outlet hose assembly to the reservoir tank.

84. Trim the bulk 3/4" hose as needed to accommodate your chosen mounting locations then secure each end with one of the supplied hose clamps.

85. Fill the recovery tank with a 50/50 mixture of coolant and water. Check the coolant level once the vehicle is able to start and water pump has cycled a few times.

Manifold Component Installation

86. Install the stock throttle body onto the supercharger using the stock O-ring gasket and bolts.

87. Install the MAF sensor (Customer Must Supply) in the slot in the plastic mass air housing so that the direction of air flow will match the direction of the arrow on the sensor. Secure the sensor using the two supplied #8-16 screws.

88. Determine the best mounting location for the air filter and mass air housing so that coldest air possible (i.e. that coming from outside the engine bay) will be drawn into the engine. The mass air housing includes three M6 x 1.0 inserts to facilitate the use of a custom bracket or shroud.

89. Construct an air intake tube between the mass air housing and the throttle body (*tube must have an inside diameter of 4" or greater. The use of silicone elbows to achieve proper sealing is recommended*). Drill a 5/8" hole with step drill, install the supplied grommet into the custom tube, then the fitting into the grommet. Attach the supplied air filter to the large end of the MAF housing.

NOTE: *Do not drill into, or otherwise modify the MAF housing.*



Edelbrock E-Force Universal Supercharger System for the LS GM Engine

Installation Instructions

WARNING: The air intake system past the MAF sensor **MUST** be air tight. This includes any PCV or crank case breathers. These should not be used. It should be installed as we describe using PCV hoses. Any leaks in the system will cause the engine to run lean, which in turn, could result in catastrophic engine damage.

90. Connect the 90° end of one of the supplied PCV hoses to the fitting that was just installed on the intake tube. Connect the straight end of the of PCV hose to the fitting on the passenger side valve cover.

91. Use a pair of pliers to remove the vacuum cap from the rear of the driver side valve cover, then Install the straight end of the second supplied PCV hose to the 10mm tube fittings on the supercharger snout and 90° fitting onto the driver side valve cover.



92. Install the supplied ETC extension harness between the main engine wiring harness and the throttle body.

93. Connect the supplied MAFS harness to the MAF sensor, the MAF and MAP connectors on the main engine wiring harness, and the TMAP sensor at the back of the supercharger. Route the harness so that it will not be abraded, pinched or scorched by other engine parts.

94. Determine appropriate mounting locations for the fuse holder and the relay on the intercooler water pump harness, then attach the appropriate connectors to their corresponding locations (See Diagram on pg. 6).

If you have yet to flash your ECU, then proceed with Steps 95-107, otherwise disregard them.
(Applicable for 1540 Kits only)

95. Confirm that you have the latest calibration by checking the Edelbrock website and entering your serial number in the search field. Once you have found the latest tune on the site, power on the programmer, press the left arrow and select the Device Info option. Scroll down to Tune Version and compare that number to the one on the site. If they are different, download the new calibration as instructed on the website.

96. Put the car into Acc mode, but don't start the vehicle.

97. Connect the supplied PCM cable to the OBD-II connector.

98. Use directional pad to highlight Program Vehicle option and press Select button.

99. Use directional pad to highlight Pre-programmed Tune option and press Select button.

100. Read disclaimer then press Select to continue.

101. Verify ignition is in the 'Key On' position but that the engine is not running then press Select.

102. Use directional pad to highlight your vehicle and transmission combination then press Select.

103. Use directional pad to highlight Begin Program then press Select.

104. Vehicles equipped with a manual transmission will have three separate operations take place during this step, while vehicles with an automatic transmission will have five. Completion of each operation will cause the progress bar to reset to zero.

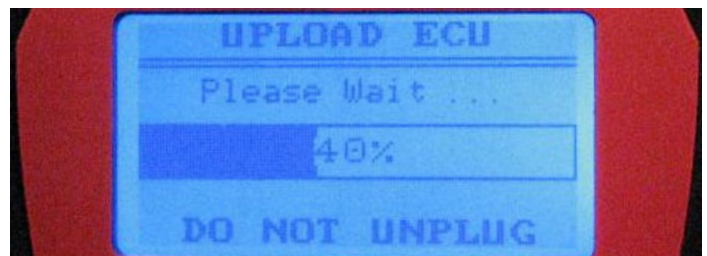

DO NOT unplug the programmer until prompted.

105. Turn the car off when prompted to do so by the handheld programmer.



Edelbrock E-Force Universal Supercharger System for the LS GM Engine

Installation Instructions

106. Read parting message from programmer then press Select to continue.

107. Unplug the programmer cable from the OBD-II port.

108. Start the car and allow it to idle while closely inspecting the engine bay for any fuel or coolant leaks. Repair any leaks before operating vehicle.

109. The vehicle must be taken to a chassis dyno to verify/adjust AFR to the desired values. You can do this by either having the vehicle custom tuned or by simply using the handheld tuner to adjust fueling up or down:

NOTE: Skip Steps 110-120 if using P/N 15430 or P/N 15480.

110. Install the supplied rubber grommets into the supplied coil cover brackets.



111. Use a 10mm socket to remove the two bolts holding the ignition coils for cylinders #2, #3, #6 & #7.

112. Locate the supplied coil cover brackets on top of the ignition coils then reinstall the ignition coil bolts.

113. Use a 10mm wrench to remove the valve cover ball stud from the driver side cover.

114. Use a 16mm wrench to install the coil cover standoffs on the valve covers.

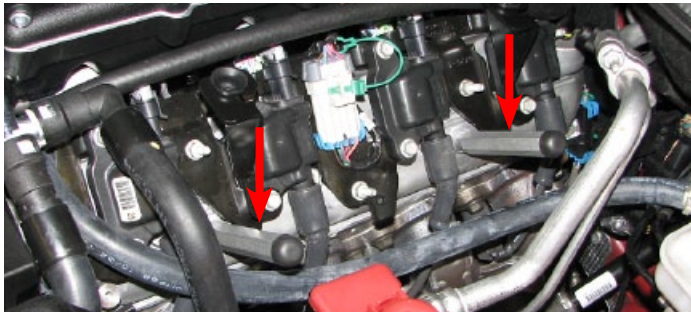

115. Use a 10mm deep socket to install the supplied ball studs into the new coil covers.

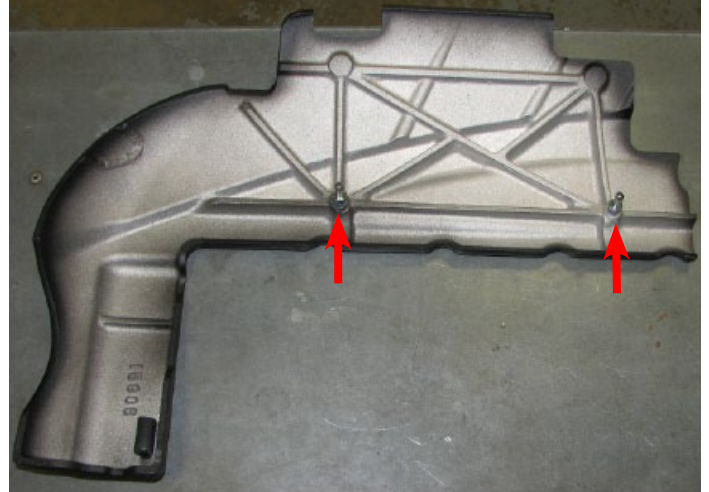

116. Install the grommet supplied in Bag #6 in the hole on the passenger side coil cover.

117. Remove the engine oil dipstick.

118. Lubricate the grommet on the passenger side coil cover then install it by sliding the grommet down and around the dipstick tube and pressing the ball studs into the bracket grommets.



119. Return the dipstick to the dipstick tube.

120. Install the driver side coil cover by sliding it into place and pressing the ball studs into bracket grommets.

Congratulations on the installation of your new Edelbrock E-Force Supercharger System. If you have any questions, please call our Technical Support hotline and one of our technicians will be happy to assist you.



Edelbrock E-Force Universal Supercharger System for the LS GM Engine

Installation Instructions

E-mail Edelbrock Your Stock PCM Calibration

In the rare occurrence that you encounter an error message that reads “Calibration not supported” during the test flash procedure on page #9, you will need to e-mail your PCM calibration to Edelbrock. Otherwise, disregard this step.

- Begin by downloading the SCT device updater software to your computer.
- Put the car into Acc mode but do not start it.
- Connect the supplied PCM cable from the tuner to the OBD-II connector.
- Select PROGRAM VEHICLE, arrow over to UPLOAD STOCK, press SELECT and follow the prompts on the screen.
- Once the stock calibration has loaded, disconnect the programmer from the OBD-II connector and connect it to your PC using the supplied USB cable.
- Open the SCT software and select the button on the lower left hand side that reads GET STOCK FILE FROM DEVICE. Follow the instructions on the screen.

NOTE: The subject line of your e-mail should be “file update needed”, The file will automatically be labeled using your VIN # followed by “.sul “ (XXXXXXXXXXXXX.sul)

- Once we have this file we can update the tune to work with your application, then we will E- mail you the custom tune which you may use until the release version is available. (This process can usually be completed within 1 to 2 business days)
- Download the new tune to the programmer using the directions received with the custom tune.
- Re-try the test flash procedure using the custom tune.