



**Edelbrock E-Force Stage II Supercharger**  
**2018-19 Ford Mustang 5.0L**  
Part #'s: 15388, 153880



## **WARNING!**

*The supercharger bypass valve is factory installed and adjusted intended to be vacuum operated only. DO NOT move the solenoid actuator lever by hand or adjust the stop point. Moving the lever manually will damage the solenoid and the system will not function properly. Damage to the bypass assembly from manual movement will not be covered under manufacture warranty.*



## Edelbrock Stage II Supercharger System 2018-19 Ford Mustang 5.0L Installation Instructions

### INTRODUCTION

Thank you for purchasing the Edelbrock E-Force Stage II Supercharger System for the 2018 Ford Mustang 5.0L. The Edelbrock E-Force Supercharger System utilizes Eaton's TVS Supercharger rotors, featuring a four lobe design for maximum efficiency, minimum temperature rise, quiet operation, and superior reliability. The inverted design places the supercharger down low in the valley, allowing for an extra large top-mount intercooler for low IATs.

Installation time: 9 Hours

### STAGE II FEATURES:

- 103mm Throttle Body
- High Flow Intake System with 113mm MAF
- 47lb/hr. Port Fuel Injectors
- Fuel Pump Voltage Booster
- 8-rib Belt Drive

### TOOLS REQUIRED

- Jack and Jack Stands  
**OR** Service Lift
- Panel Pullers
- Ratchet and Socket Set including 7mm, 8mm (deep), 10mm, 10mm (deep), 12mm, 13mm, 15mm,
- 5mm & 6mm Allen Sockets
- T25 Socket
- 3/8" Extension
- 19mm Wrench
- 3/8" Breaker Bar
- Screwdrivers
- Pliers **OR** Hose Clamp Pliers
- Impact Wrench
- 90° Pick
- Blue Thread Lock Fluid
- O-ring Lube
- Masking Tape
- 90° Drill
- Torque Wrench
- 2 Gallons Motocraft Antifreeze/Coolant VC-3DIL-B Orange Pre-Diluted



Edelbrock Stage II Supercharger System  
2018-19 Ford Mustang 5.0L  
Installation Instructions

**IMPORTANT WARNINGS**

***Before beginning the installation, use the enclosed checklist to verify that all components are present in the box. Then inspect each component for damages that may have occurred in transit.***



**WARNING:** Installation of this supercharger will result in a significant change to the performance characteristics of your vehicle. It is highly recommended that you take some time to familiarize yourself with the added power and how it is delivered. It's highly recommend to do this in a controlled environment. Take extra care on wet and slippery roads, as the rear tires will be more likely to lose traction with the added power. It is never recommended to turn off your vehicles traction control system.

***Proper installation is the responsibility of the installer. Improper installation will void all manufacture's standard warranties and may result in poor performance and engine or vehicle damage.***

Due to the complexity of the Edelbrock E-Force Supercharging system, it is recommended that this system only be installed by a qualified professional with access to a service lift, pneumatic tools, and a strong familiarity with automotive service procedures. To qualify for the optional supplemental warranty, it is necessary to have this system installed by a Certified ASE Technician, Ford Dealership, or an Authorized Edelbrock Installer. Failure to do so will void and/or disqualify any and all optional supplemental warranties offered with this system. Please contact the Edelbrock Technical Support department if you have any questions regarding this system and/or how your installer of choice will affect any warranty coverage for which your vehicle may qualify.

***Any previously installed aftermarket tuning equipment must be removed and the vehicle returned to an as stock condition before installing the supercharger.***

Any equipment that directly modifies the fuel mixture or ignition timing of the engine can cause severe engine damage if used in conjunction with the Edelbrock E-Force Supercharger System. This includes, but is not limited to: ignition boxes, air/fuel controllers, OBDII programmers, and any other device that modifies signals to and/or from the ECU. Aftermarket bolt-on equipment such as underdrive pulleys or air intake kits will also conflict with the operation of the supercharger and must be removed prior to installation. Use of any of these products with the E-Force Supercharger could result in severe engine damage.

***Edelbrock periodically releases improved versions of the calibration file found on the supplied handheld programmer.***



## IMPORTANT WARNINGS (CONTINUE)

***The supercharger manifold includes a 1/8 NPT port to accommodate the installation of a boost gauge or pressure transducer. Remove the plug and replace it with a fitting to attach your gauge or sensor.***

The supercharger has been pre-drilled and tapped for a 1/8" NPT fitting at the rear of the passenger side intake runner flange. There is currently a plug sealing the hole, which can be removed, and replaced with a fitting to adapt to your sensor. **CAUTION:** Never cut into the vacuum lines leading to the bypass actuator for the purpose of tapping in a boost gauge. This can result in boost pressure readings that are higher than what is actually present in the intake plenum.

***Do not use a wideband oxygen sensor in place of the rear O2 sensor when dyno testing this supercharger system. The voltage signal will cause the fuel system to run lean and possibly cause engine damage.***



***91 octane or higher gasoline is required at all times. If your vehicle has been filled with anything less, it must be run until dry and refilled with 91 or higher octane gasoline twice prior to installation.***

***Failure to use the required 91 octane gasoline or higher could permanently damage your engine. Any failures associated with not using premium 91 octane gasoline or higher, will be ineligible for warranty repairs.***



**WARNING:** Installation of this supercharger and charge air cooler may require removal and replacement of front grille, front bumpers, or other pieces which may be equipped with Advanced Driver Assistance Systems (ADAS). ADAS Systems include, without limitation:

- Forward Collision Warning
- Auto braking
- Lane Departure Warning
- Lane Keeping Assist
- Blind Spot Warning
- Rear Cross Traffic
- Rearview Camera
- And various other OEM ADAS Equipment

It is the responsibility of the installer to ensure that all necessary ADAS systems that require post-repair calibrations/targeting/aiming is performed by qualified repair facilities. Edelbrock assumes no liability whatsoever with respect to any damages or losses with respect to any ADAS systems.

### Edelbrock Authorized Installer Disclaimer

*Authorized installers of Edelbrock products are independent companies over which Edelbrock has no right of control. Edelbrock LLC makes no claims regarding the abilities, expertise or competency of individual employees of any authorized installer. Each authorized installer is an independent company and makes its own independent judgments. Edelbrock LLC specifically disclaims any responsibility to any party including third parties for the actions, or the failure to act, of individuals, agents or a company authorized in the installation of Edelbrock LLC products.*

**INSTALLATION HARDWARE IDENTIFICATION GUIDE**

*(Parts Are Not To Scale)*

BAG #1 - MANIFOLD HARDWARE			
Item	P/N	QTY.	Description
1	36-1508	10	Bolt, Hex Flange, M6 x 30mm
2	36-1575	2	Bolt, Hex Flange, M6 x 25mm
3	38-0186	8	Bracket, Injector
4	51-7092	1	Rubber Plug
5	68-0095	16	Bolt, BHCS, M4 x 4mm
6	36-1582	4	Bolt, SHCS, M6 x 25mm
7	36-1507	4	Bolt, Hex Flange, M6 x 16mm
8	51-4093	1	O-Ring, Throttle Body (not pictured)
9	36-1535	4	Bolt, SHCS, M6 x 20mm,
10	36-4042	4	Bolt, Hex Flange M6 x 45mm

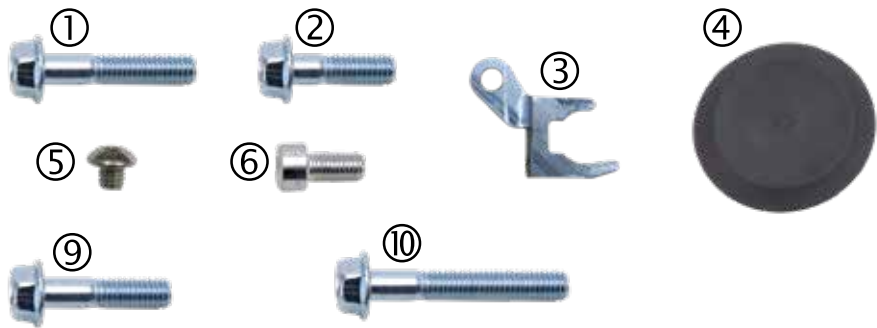

BAG #2 - FEAD HARDWARE			
Item	P/N	QTY.	Description
1	36-6407	1	Crank Bolt, Coyote 5.0L (Ford BR3Z-6A340-A)
2	36-4029	1	Bolt, M8 X 100MM
3	36-3812	3	Bolt, M8 X 90MM
4	36-4013	2	Bolt, M8 x 45mm
5	36-6082	1	Nut, M14 X 21mm
6	82-0120	2	Washer, M8 x 24mm O.D. X 2mm
7	82-5592	2	Washer, 7/16 X 7/8 X 0.075, Flat, Zinc
8	36-1531	2	Bolt, M8 x 35mm
9	36-4041	1	Bolt, M8 x 40mm



BAG #3 - INTERCOOLER HARDWARE			
Item	P/N	QTY.	Description
1	36-1518	2	Bolt, Hex Flange, M8 x 30mm
2	36-1552	6	Bolt, Hex Flange, M6 x 10mm
3	36-8572	6	M8 Nut
4	82-0120	2	M8 Washer
5	46-2155	8	3/4" Hose Clamp
6	60-1508	1	M6 Locknut



### HOSE IDENTIFICATION GUIDE

(Parts Are Not To Scale)

INTERCOOLER AND PCV HOSES			
Item	P/N	QTY.	Description
1	56-1601	1	Hose, 3/8" Cadbar
2	56-1613	1	Hose, Aspirator to Manifold
3	56-1602	1	Hose, 1/2" Cadbar
4	22-1685	1	Hose, Aspirator to Elbow
5	56-1614	1	Hose, Coolant Bleed
6	56-1610	1	Hose, SC to Surge Tank
7	56-1609	1	Hose, LTR to SC
8	56-1607	1	Hose, Surge Tank to Water pump
9	56-1608	1	Hose, Water pump to LTR
10	56-1600	1	Hose, Driver's Side Fuel Line Cover.

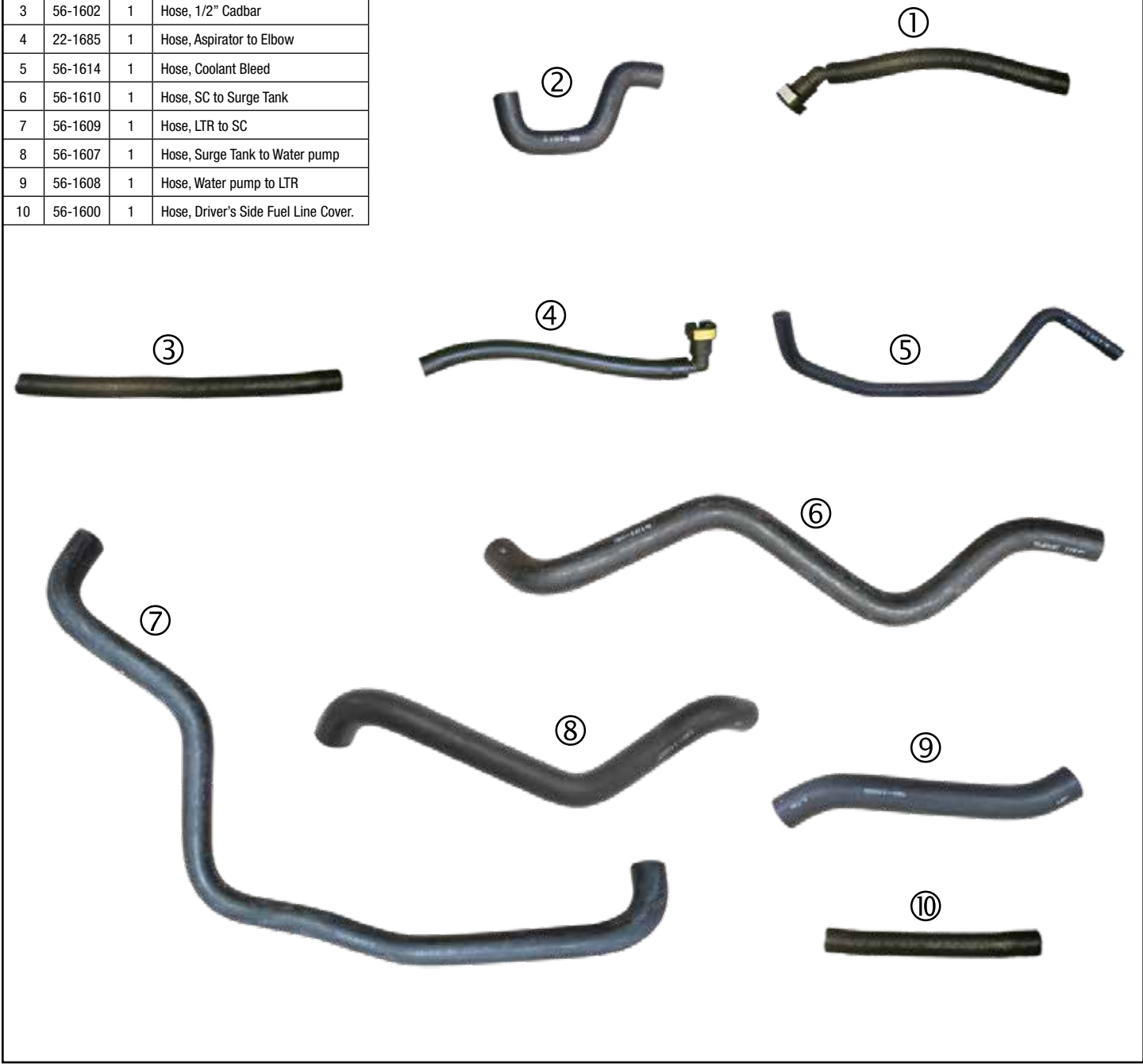

**WIRE HARNESS GUIDE**

WIRE HARNESSES			
Item	P/N	QTY.	Description
1	37-6627	1	ACT/MAF Sensor Harness
2	37-1641	1	Water Pump/EVAP Harness

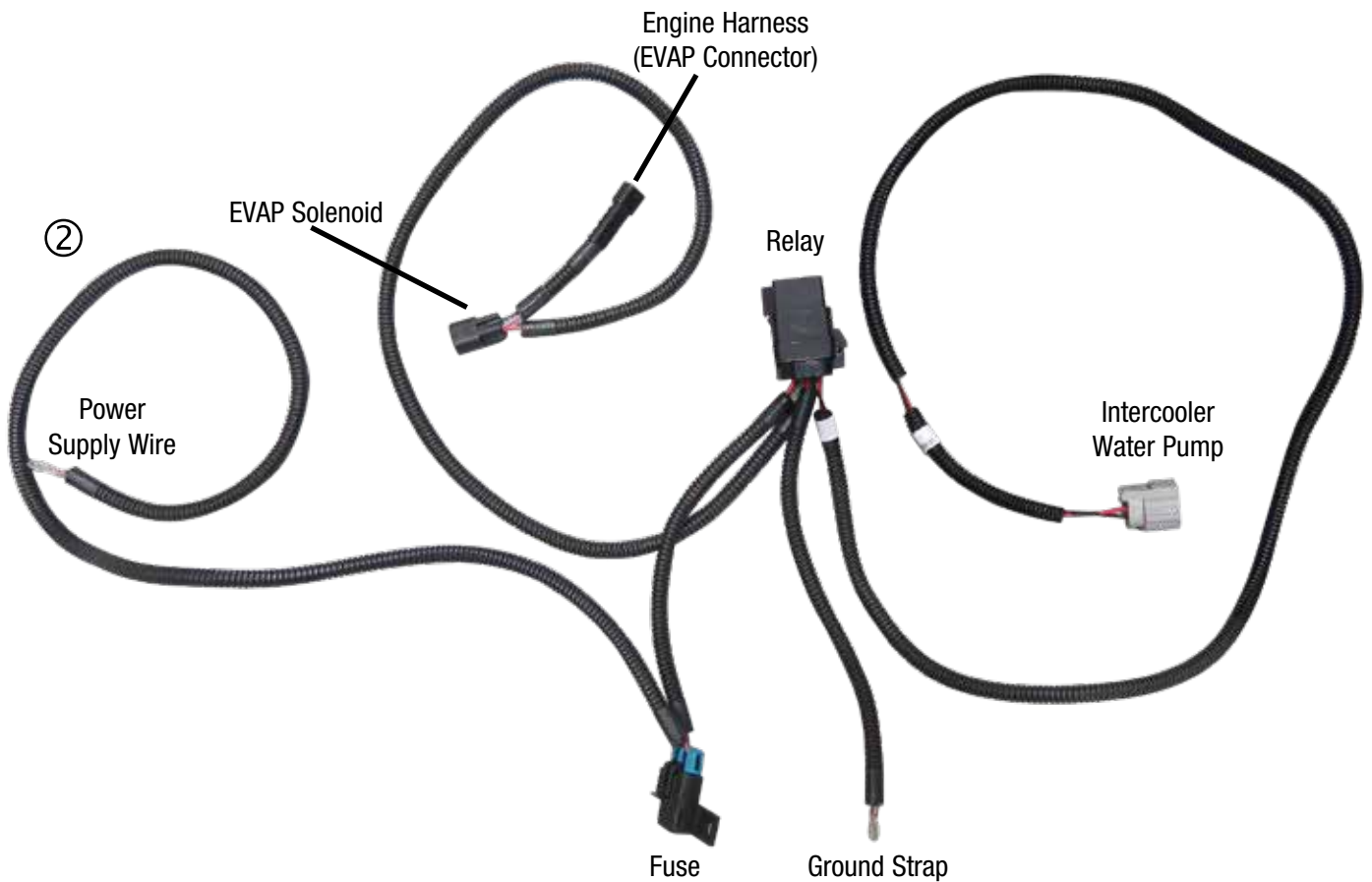

**INTERCOOLER HOSE ROUTING GUIDE**

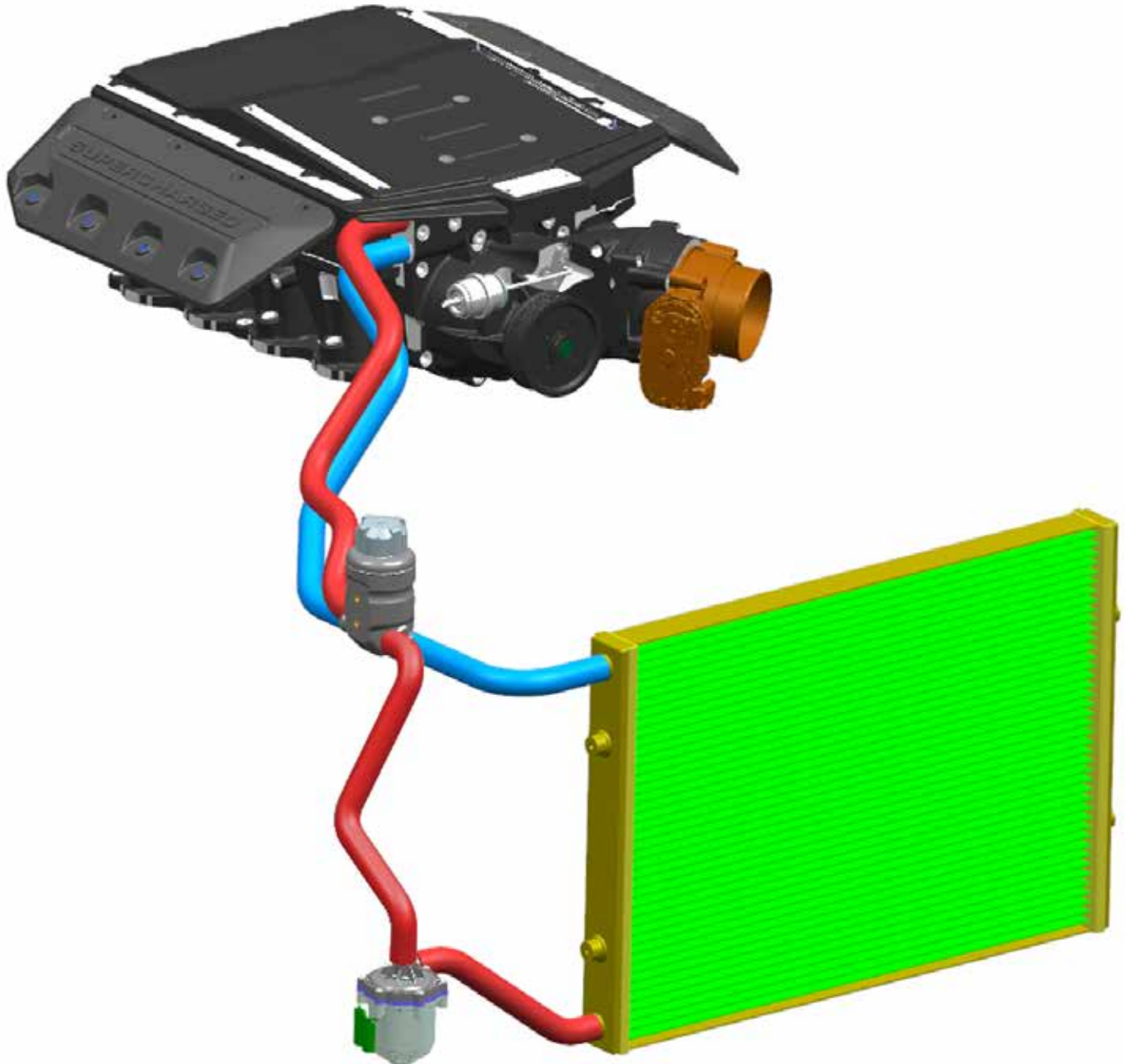

### 2018-2019 SCT BDx Instructions

**WARNING: Battery must be sufficiently charged before starting the PCM flashing procedure.**

**Do not flash the PCM until you are ready to install the supercharger. Once the PCM is flashed, DO NOT START the engine until the installation of the E-Force supercharger is complete.**



Figure 1

1. Begin by downloading the SCT device updater software.
2. With the device updater open, connect the BDx to your PC with the supplied USB cable and verify it is up to date by selecting **AUTOMATICALLY CHECK FOR UPDATES**. (Figure 1)
3. Once any updates have been completed, use the supplied OBD cable to connect the BDx to the vehicles OBD port.
4. Put the vehicles ignition into ACC mode but do not start the engine.
5. Select VEHICLE INFO to find the ECU strategy number.

- a. Model Year
- b. Transmission Type (auto or manual)
- c. Fuel Octane Desired (91 or 93)

**NOTE: If there is a message which reads "Calibration not supported", see page 34.**

**6.** Once you have received the updated supercharger calibration file, reconnect the BDx to your PC and open the SCT device updater software. Recheck for updates by clicking AUTOMATICALLY CHECK FOR UPDATES once more.

**7.** Once any updates have completed, save the updated supercharger calibration from the Edelbrock email to your PC. Then select LOAD CUSTOM TUNE FILE. (Figure 2)

**8.** Select BROWSE to find the updated supercharger calibration file you just saved to your PC. (Figure 3)

**9.** Once the file is located, highlight the supercharger calibration (EForce) and select ADD TO DEVICE. Then click PROGRAM to complete the transfer. (Figure 4)

(CONTINUED ON NEXT PAGE)

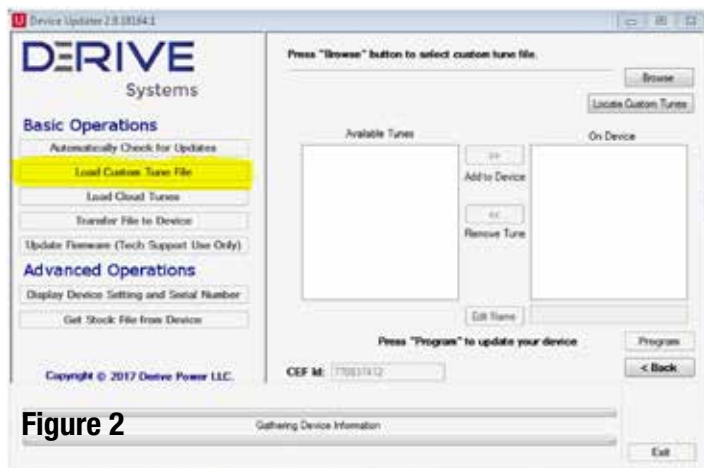

Figure 2

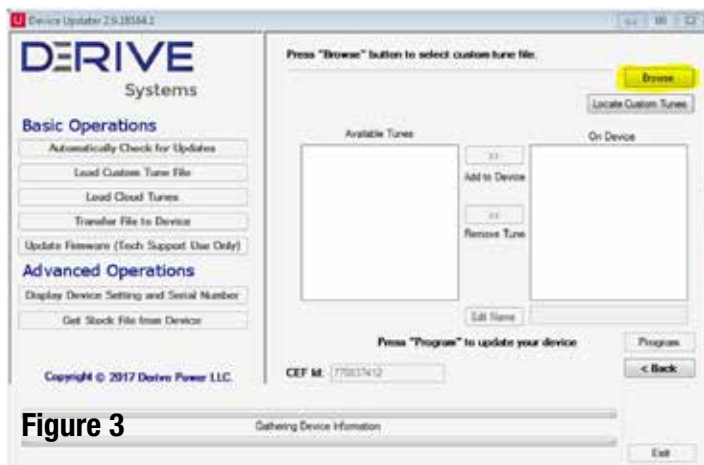

Figure 3

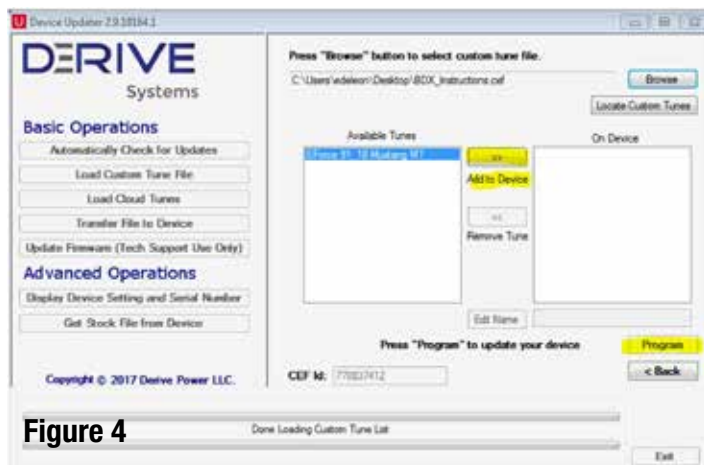

Figure 4

### 2018-2019 SCT BDX Instructions (Continued)



**10.** After verifying the VIN# you will be prompted to connect the BDX to WIFI.



**11.** Select the available WIFI network and follow the prompts to complete the connection. With a successful WIFI connection established, the programmer will begin updating files and firmware for the BDX.



**12.** At this time, disconnect the cable to your original throttle body.



**13.** Plug in the new 103mm throttle body and place it on the radiator support as shown here. ***THIS IS REQUIRED FOR THE FLASH TO BE EFFECTIVE.***

Use the supplied OBD cable to connect the BDX to the vehicles OBD port.

Put the vehicles ignition into ACC mode but do not start the engine.



**14.** Once all WIFI updates are completed, a ***CLOUD SYNC*** screen will appear. Select ***SKIP***, as we will be emailing the E-Force calibration file to you.



**15.** After selecting ***SKIP*** for the ***CLOUD SYNC***, the ***STREET USE NOTICE*** will appear. Select ***CONTINUE*** and then ***CUSTOM TUNES***, then the EFORCE file for your vehicle.

Follow the prompts given by the programmer to complete the flash

#### INFORMATION NEEDED:

- E-Mail Address:
- Vehicle Year:
- Vehicle Make:
- Vehicle Model (Specify if GT, Shelby, Bullit, etc.):
- Engine Size:

- Transmission:
- Fuel Octane (91 or 93 ONLY):
- Supercharger System Part Number:
- Supercharger Serial Number:
- Programmer Serial Number:

**SUPERCHARGER INSTALLATION**

1. Using a panel puller, remove three (3) tree clips securing the battery cover.



2. Using an 10mm socket, remove the negative battery terminal and place it away from the battery. Cover the post to avoid accidental contact during the installation.



3. Using a panel puller, remove eight (8) push pins securing the top radiator shroud. Remove the shroud and set aside.



4. Remove six (6) bolts securing the top of the fascia using an 8mm socket.



5. Using a 5.5mm socket, remove two (2) bolts under the weather stripping, one per side.



6. (Fig. 1) On Performance Package Vehicles, Remove eight (8) push pins securing the splash guard using a panel puller. (Fig. 2) For all other models, remove six (2) push pins and (4) screws. The splash guard will be removed with the bumper.



7. Using a panel puller, remove three (3) push pins securing the wheel well liner to the fascia. **TIP:** Removal of the front wheels is not required but will make accessing the push pins easier.



8. There is an additional push pin located just above the tire that needs to be removed.



9. Reaching through the shown opening, remove four (4) nuts, two per side, securing the fascia to the fender using a 10mm socket.

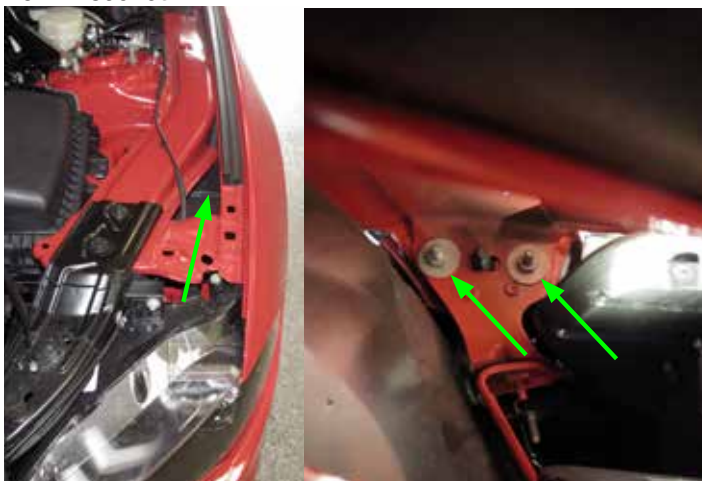

10. From within the wheel well remove the fascia retention assembly that the nuts were removed from in the previous step. Pull downward until the plastic pin no longer retains the assembly. Remove from vehicle, ensuring to distinguish between passenger and driver side.



11. Unplug the fog lamp and signal light connectors (3 lights in total), on both sides of the fascia.



Fig. 1

12. Tape up the fender as needed to prevent scratching the painted surfaces. With the help from an assistant, carefully disengage both sides of the fascia by gently pulling the sides outwards. Remove the fascia and set aside.



Fig. 2

13. Drain the coolant by loosening the petcock located on the passenger side of the radiator. **TIP:** *Placing a hose onto the drain spout will reduce potential coolant spillage.*



14. Remove the front strut tower brace (if equipped) using a 15mm socket. **NOTE:** *The brace will not clear the supercharger manifold and cannot be used. The bolts securing the brace can be reinstalled once the brace is removed.*



15. Gently lift up the engine cover and remove.

16. Using a hose clamp tool, or equivalent, remove the sound generator hose from the air inlet tube.



17. Remove the brake aspirator hose from the air inlet tube.



18. Remove the driver side PCV hose from the air inlet tube.



19. Remove the additional brake aspirator hose from the air inlet tube.



20. Disconnect the brake aspirator hose from the manifold PCV hose.



21. Using a flathead screwdriver (or 7mm socket), loosen two (2) worm clamps securing the air inlet tube and remove.



22. Disconnect the EVAP hose and electrical connector.



23. Using a hose clamp tool and pliers, remove the brake aspirator hose from the intake manifold.



24. Remove the brake aspirator hose assembly from the brake booster and set aside as it will be reused later.



25. Remove the sound generator assembly using a 10mm socket and plug the hole in the firewall using the supplied plastic grommet plug supplied in Bag # 1.



26. Remove the passenger side PCV hose from the valve cover and the intake manifold.



27. Disconnect the throttle body connector.



28. Using an 10mm socket, remove four (4) bolts securing the heater hose retaining brackets.



29. Remove the retaining brackets and the foam insulators from the fuel rails.



30. Disconnect eight (8) fuel injector connectors.

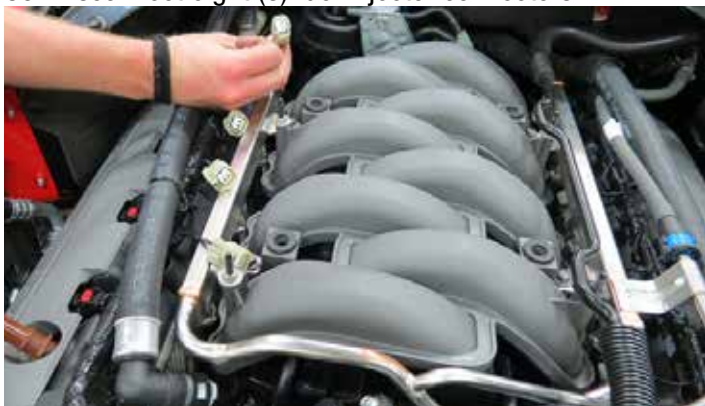

31. With the vehicle **COMPLETELY** cooled. Put rags under the fuel rail fitting and remove the fuel line from the rail. Cap off the fuel rail and fuel line with appropriate cap and plug to prevent spillage. Clean up any spilt fuel before proceeding.



32. Repeating spill protection procedures from step 31, remove the fuel line from the passenger side fuel rail. Use a 3/8" fuel line disconnect tool to remove the line.

33. Using a 10mm socket, remove four (4) bolts securing the fuel rail and manifold. **TIP:** *It's not required to fully remove the fuel rails.*

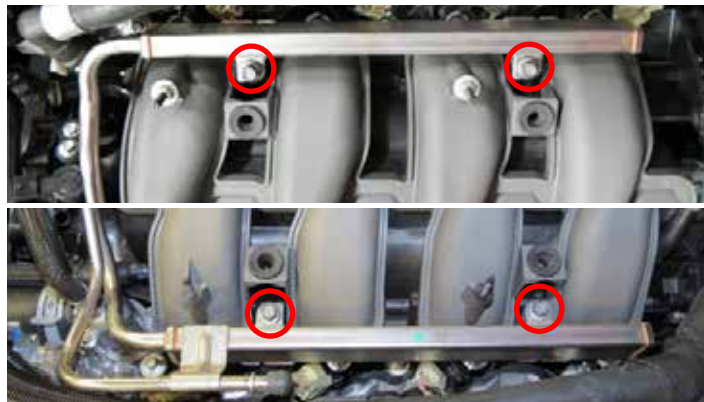

34. Using an 8mm socket, remove six (6) manifold bolts.



35. With the stock manifold remaining in the vehicle, rotate and manipulate it until you are able to remove the 4 connectors from the rear of the manifold as shown below. Disconnect any plastic anchors from the back of the manifold.

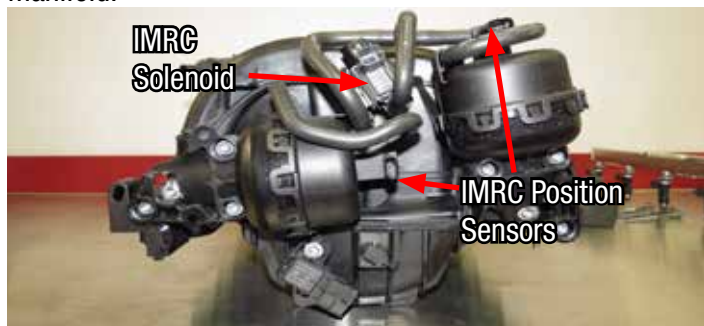

36. Make sure the IMRC harness is completely disconnected from above locations and remove the manifold. Clean the cylinder head flanges as needed and tape up the ports to prevent debris from falling into the ports. **NOTE:** Adjust the upper radiator hose clamp position to point more towards the driver's side of the vehicle. The supercharger housing will be occupying this space later. (See arrow)



37. Remove the IMRC Solenoid from the manifold. Reconnect to the harness and zip tie out of the way. The solenoid will not be used but **MUST** be plugged in for proper engine operation.



38. Tape up the end of the two (2) IMRC position sensor plugs and secure plugs to the main harness out of the way. These will not be reused.

39. Using a 10mm socket, remove two (2) bolts securing the coolant reservoir.



40. Position the coolant reservoir tank out of the way to access the drive belt tensioner.

41. Rotate the belt tensioner counterclockwise using a 15mm socket and breaker bar, then remove the drive belt.



42. Remove the two (2) indicated engine cover bolts on the using a 10mm socket. Using a 90° drill and the supplied drill bit, drill out the indicated hole on the front engine cover 1.01" deep. The hole should be tapped to M8 x 1.25 with the supplied tap.

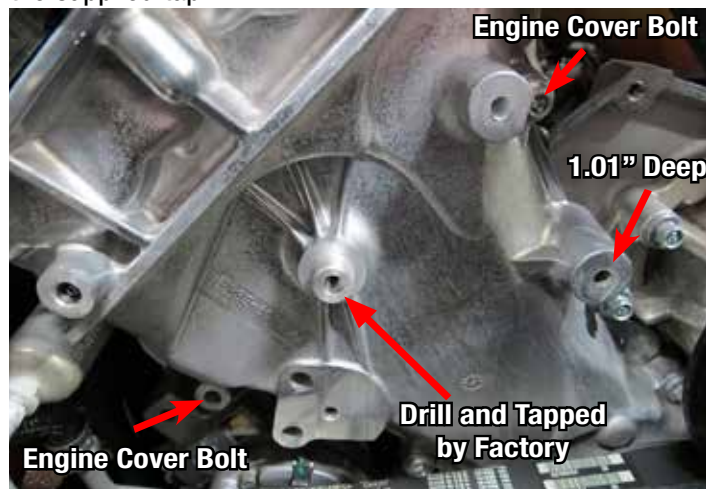

43. Install the 8-Rib FEAD bracket using the provided bolts and spacers. Use the image below as a guide for bolt and spacer locations. Torque bolts to 18 lb/ft.

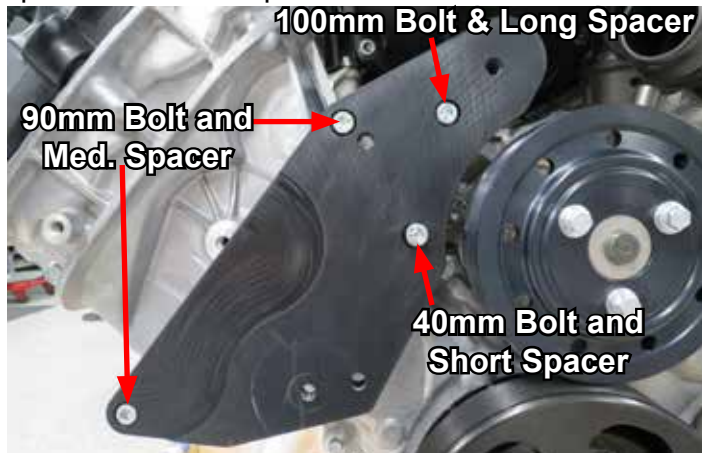

44. Install one of the 74mm idlers onto the FEAD bracket using one (1) M10 x 45mm socket head bolt, one (1) 7/16" washer and one (1) idler mounting boss. Torque bolt to 22 lb/ft.



45. Install the 63mm idler onto the FEAD bracket using one (1) M10 x 45mm socket head bolt, one (1) 7/16" washer and one (1) idler mounting boss. Torque bolt to 22 lb/ft.



46. Remove the bolt securing the plastic idler on the driver side of the engine. The idler and hardware will not be reused.



47. Using a 13mm socket, remove the factory tensioner adjacent to the alternator and balancer.



48. Remove both the engine cover bolt using a 10mm socket and the bolt through the ear of the alternator using a 15mm socket.



## Edelbrock Stage II Supercharger System 2018-19 Ford Mustang 5.0L Installation Instructions

49. Secure the idler bracket by installing bolts from Bag # 2. The M10 x 110mm bolt through the ear of the alternator, the M8 x 90mm bolt into the top front cover hole, and the M10 x 45mm bolt through the lower hole that was used to secure the stock tensioner. Use blue thread lock fluid on all of the bolt threads and torque all bolts to 22 ft-lbs.

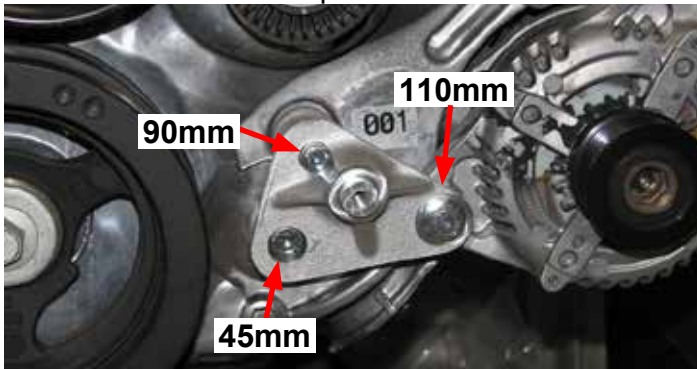

50. Install the two (2) 74mm idler pulleys using the provided M8 x 35mm hex flange bolts and M8 washers. Torque bolts to 18 lb/ft.

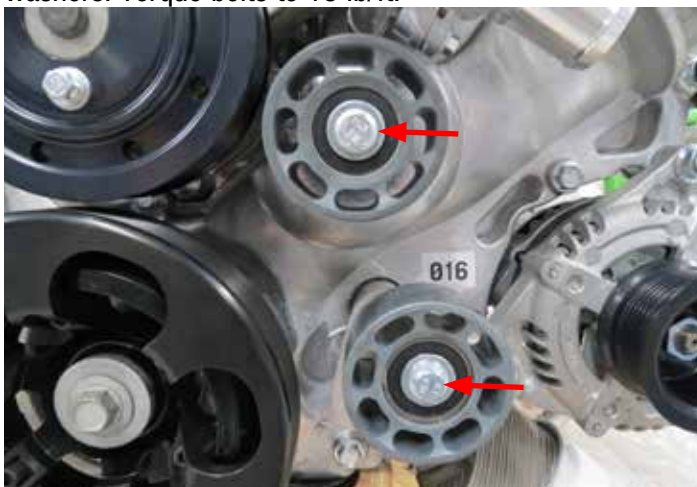

51. Using a 17mm Allen socket and impact wrench, remove the factory alternator pulley.



52. Remove the A/C belt by wedging a screwdriver or pry tool between the belt and AC pulley while rotating the engine using a large ratchet with 18mm socket. .

53. Using an 18mm socket and impact wrench, remove the factory harmonic damper bolt. Save the washer and discard the bolt.

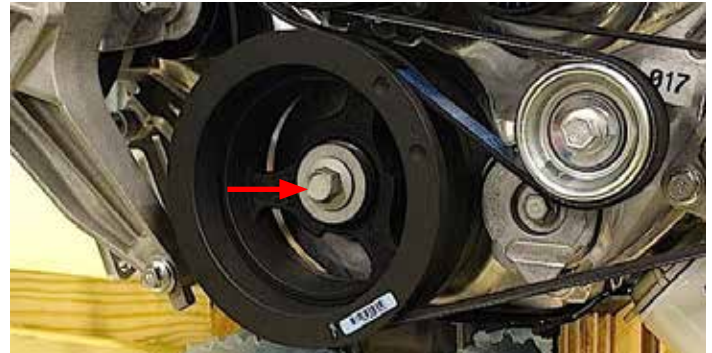

54. Using a pulley puller, remove the factory harmonic damper from the crankshaft.

**NOTE: Steps 55-57 are for installing the provided 8-Rib harmonic damper. Use the image below for reference.**

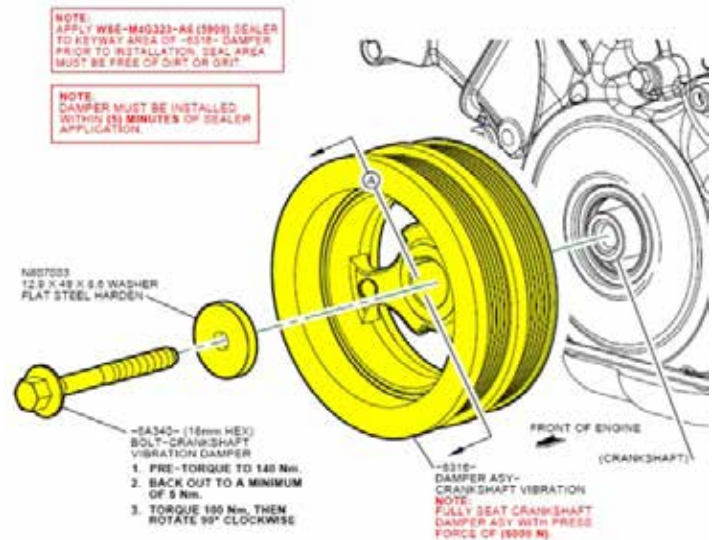

55. Assemble the 2-piece crank pulley before installation. Completely clean the provided harmonic balancer and crankshaft snout, then apply Loctite SI 5900 or equivalent to the damper keyway area.

56. Using a pulley installation tool, install the 8-Rib balancer making sure that it is fully seated on the crankshaft.

57. Using the provided damper bolt and factory washer saved during step 53, secure the damper to the crankshaft using the torque procedure in the above diagram (**Torque to 103 lb/ft, Back out to 3 lb/ft, Torque to 74 lb/ft, rotate 90° clockwise**).

58. Position the A/C compressor belt on the crank pulley grooves nearest the engine first. Using a screwdriver or pry bar, feed the belt on to the A/C pulley while turning the crankshaft pulley using an 18mm socket with a long ratchet until fully seated.



59. Rotate the crankshaft clockwise 1 full rotation to verify the A/C compressor belt has correctly seated onto the crankshaft and A/C compressor pulley. Inspect the belt for any damages before proceeding.

60. Remove the 6-Rib water pump pulley and replace with the provided 8-Rib pulley using the existing hardware. Use a strap-wrench to hold the pulley while tightening. **NOTE: Bolts should be installed with Blue Loctite.**



61. Install the 8-Rib alternator pulley using the provided M14 nut. Use a strap wrench to hold the pulley while tightening. **NOTE: Nut should be installed with Blue Loctite.**



62. Wrap the 8-Rib belt around the tensioner pulley first, then install the new tensioner onto the bracket using the included M10 bolt. Verify that the tensioner is clocked correctly by aligning the index pin with the hole on the bracket, then torque the bolt to 32 lb/ft. Adjust AC line as needed.



63. Unclip each coil connector and use an 8mm socket to unbolt each coil pack. Label and remove each coil pack so that they are re-installed in the correct cylinder. Remove the spark plugs with a 5/8" spark plug socket and replace them with the supplied SP-522 Motorcraft spark plugs or equivalent. Use a small amount of anti-seize on each new plug. **NOTE: Gap the supplied spark plugs to .035.** Reinstall the plugs and torque them to 9 ft-lbs., then reinstall the OEM coils and coil covers.

64. Place a rag under the passenger side heater hose and remove the heater hose from the fitting located on the cylinder head.



## Edelbrock Stage II Supercharger System 2018-19 Ford Mustang 5.0L Installation Instructions

65. Remove the passenger side heater hose fitting with an 8mm socket. Repeat for the driver side heater hose fitting. Temporarily plug the holes with a rag.



66. Using a hose clamp tool, remove the factory coolant bleed hose from the reservoir and bleeder fitting. These clamps and sheathing will be reused later in the installation. **NOTE:** Do not over-stretch these clamps since they will be reused.



67. Remove the O-ring manifold gaskets from the factory manifold and install them onto the supercharger runners. Apply a small amount of O-ring lubricant to the exposed area of the gaskets. This will help prevent tears during installation of the supercharger.



68. Apply blue thread lock fluid onto the threads of the eight (8) M6 x 12mm SHCS bolts from the side cover kit and loosely screw on the side cover brackets to the underside of the supercharger lid.

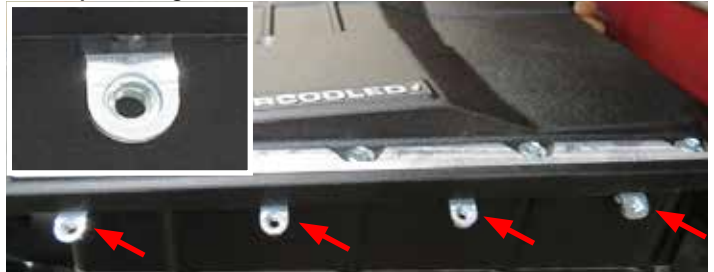

69. For proper bracket alignment, test fit the side covers onto the brackets using eight (8) M6 X 25mm bolts from the side cover kit. While pushing the side covers forward, fully tighten the bracket bolts. Once all brackets are aligned and tightened, remove the side covers.



70. Using O-ring lube, install the fuel caps onto the fuel rails. Attach the supplied fuel crossover to the rear of both rails. Insert the straight fittings into the fuel rails as shown.



71. Install injector orientation brackets using the M4 x 4mm screws from Bag # 1.



72. Apply O-ring lube to both ends of the supplied fuel injectors, then install them into the supplied fuel rails, oriented so the electrical connectors will face away from the supercharger.

73. Remove the factory fuel pressure sensor from the driver side factory fuel rail.



74. Thread the adapter into the supercharger fuel rail until snug. **Be sure not to overtighten and strip threads.** Thread the fuel pressure sensor and into the adapter. To prevent the adapter from twisting in further, use a second wrench. Optionally continue to twist the sensor once snug until it aligns with fuel rail.



75. Temporarily install the fuel rail assembly onto the supercharger manifold.

76. Be sure that the engine bay is clean and free of debris, then remove the masking tape used to protect the intake ports from contamination.

77. With the help of an assistant, carefully lower the supercharger manifold onto the cylinder heads. Be especially careful not to pinch any wires between the supercharger and the cylinder heads. **(RHD vehicles may require additional trimming for supercharger lid clearance).**



78. Undo the fuel rails and move them away from the supercharger to access the supercharger manifold bolts. Secure the supercharger manifold to the cylinder heads using a 10mm swivel socket to install ten (10) M6 x 30mm intake manifold bolts supplied in hardware Bag # 1. Using the torque sequence below, torque the bolts to 8 ft-lbs.

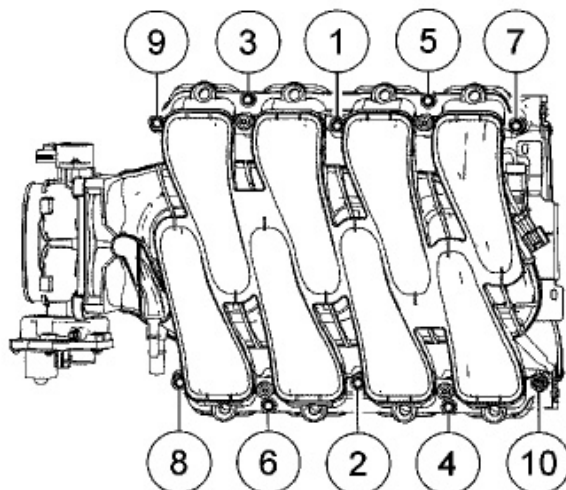

79. Pull wire harness off of the valve cover to gain access to fuel rails. Install the fuel rails and secure using four (4) M6 x 16mm bolts from Bag # 1. Bolt holes are located beneath the fuel rail. **Start fuel rail bolts BY HAND first and make sure thread engagement is smooth before tightening with tool.**



80. Reconnect the injector connectors to the appropriate fuel injectors. **WARNING: Never attempt to rotate the injectors.**

81. Connect the factory fuel lines to the straight fittings on the driver and passenger side fuel rails.



82. Reinstall the passenger side heater hose fitting using the factory hardware.



83. Reconnect the passenger side heater hose.



84. Remove the evap solenoid from the factory manifold. Install the solenoid onto the bracket using the factory rubber grommet. Connect the hose from the supercharger nose and connect the factory EVAP hose. Put the evap in position and leave the bracket loose until the supercharger installation is complete.

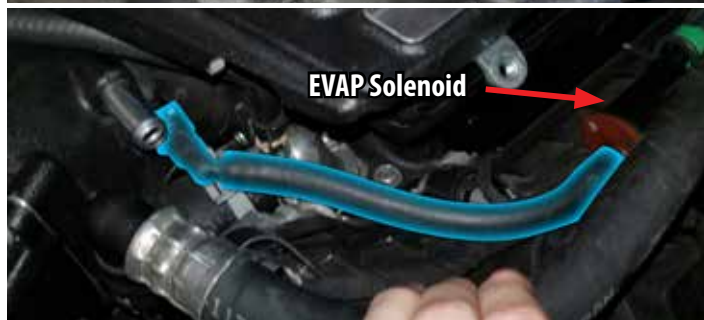

85. Use a 1/2" breaker bar to rotate the tensioner clockwise, finish installing the supplied belt according to the routing diagram shown below.

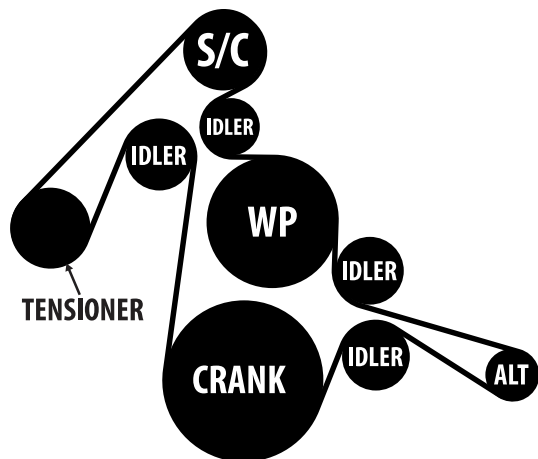

86. Reinstall the cool fan assembly and connect plug. Using the two (2) factory bolts, reinstall the coolant reservoir with a 10mm socket.



87. Install factory protective sheathing onto the new coolant bleed hose. Install the supplied coolant bleed hose and secure with the factory hose clamps.



88. Carefully remove the protective foam from the brake aspirator.



89. Remove the hose that attaches to the check valve and replace with the supplied 3/8" hose. Attach the supplied vacuum cap to the opposite end of the aspirator.

90. Remove the other two hoses from the brake aspirator and attach the Aspirator to Manifold hose and the Aspirator to Elbow hose as shown.



91. Attach the brake booster hose on the aspirator hose assembly to the check valve.



92. Route the Aspirator to Manifold hose under the heater hose and EVAP hose, and attach to the fitting on the supercharger nose.



93. If equipped, remove the four (4) 8mm bolts attaching the shutters to the crash guard and radiator support.

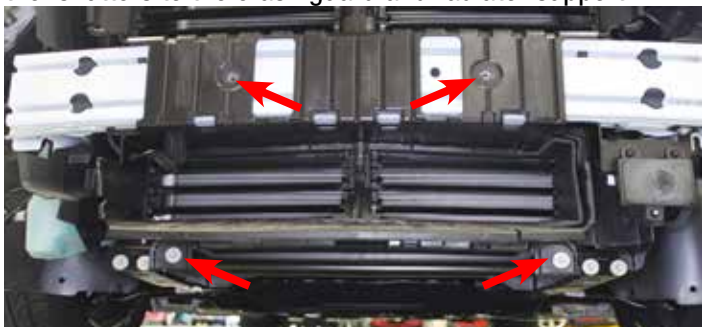

94. Remove the two (2) clips securing the shutter bracket to the core support.

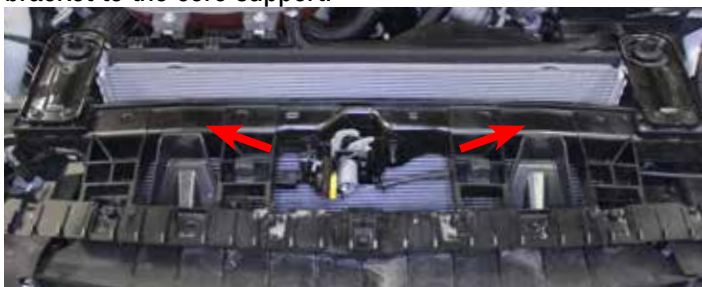

95. In front of the radiator, undo the lower shutter actuator arm by removing the two (2) 5.5mm bolts pictured. Swing out of the way and pull the shutters out through the front of the vehicle. Pry ambient air temperature sensor and bracket from bottom of crash bar and pull wiring through the slot in the shutter assembly. Pull shutter forward and unplug, then unplug connector in center backside of shutter assembly. Then completely remove shutters from vehicle and set aside.

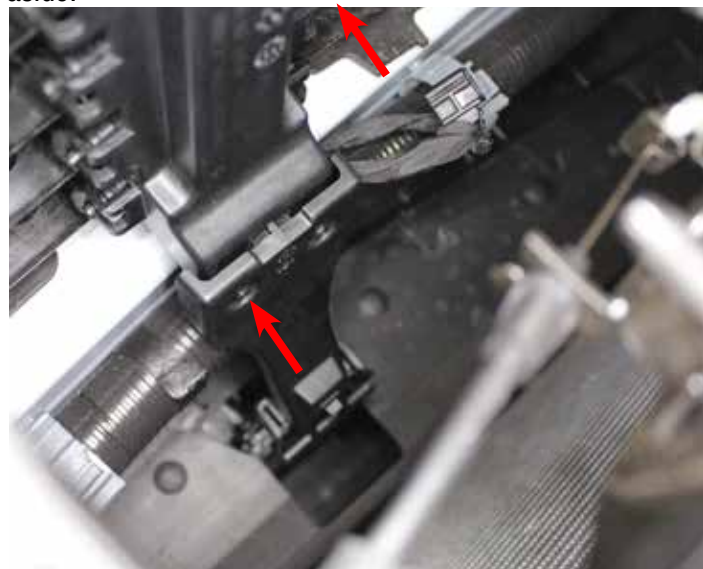

96. Remove the crash beam cross braces, if equipped.



97. Back out the four (4) crash beam bolts (circled in image) until they no longer protrude out of the back. Install the LTR brackets from behind the crash beam and onto the crash beam support studs. Line up the holes on the LTR brackets with the studs to temporarily hold the LTR brackets in place. Thread in crash bar bolts to help hold the brackets. Then install the LTR from below as pictured.



98. Install the supplied cross braces using the two (2) M8 x 30mm hex flange bolts from Bag # 3, loosely screw in the bolts through the crash beam braces. The lower cross braces will sandwich the LTR to the crash beam and be secured using the M8 nuts and washers supplied in Bag # 3. Once all bolts are in place through the braces, fully tighten the bolts and nuts.

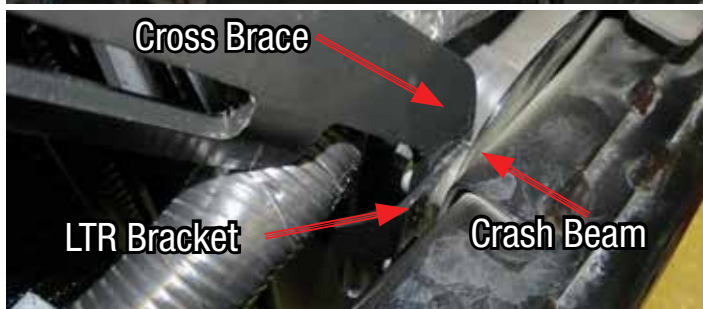

99. Using a drill and a 1 1/4" hole saw bit, drill a hole in the shroud that lines up vertically and parallel with the lower LTR barb.



100. Cut a hole in the shroud that the upper LTR hose can route through. **CAUTION:** Be mindful of the A/C hard lines behind the shroud.



101. Attach the LTR to WP hose to the water pump and secure with a hose clamp from Bag #3.



## Edelbrock Stage II Supercharger System 2018-19 Ford Mustang 5.0L Installation Instructions

102. Feed the hose through the hole in the shroud and secure the water pump to the chassis using the supplied nuts in Bag #3.



103. Secure the hose to the LTR with a hose clamp from Bag #3.



104. Insert the LTR to Manifold hose through the hole on the upper shroud and secure to the top LTR bung with a hose clamp from Bag #3. Secure the other end to the lower bung on the supercharger manifold.



105. Attach the surge tank bracket to the surge tank using two (2) M6 x 10mm bolts from Hardware Bag #3. Also attach the water pump hose to the surge tank and secure it with a hose clamp from Bag #3.



106. Connect the Water pump to Surge tank hose to the water pump and secure with a hose clamp from Bag #3.



107. Secure the Surge Tank to Manifold hose to the surge tank and manifold using two (2) hose clamps from Bag #3.



108. Using a 10mm socket, remove the top bolt securing the windshield wiper fluid reservoir. Place the surge tank bracket onto reservoir and secure the bracket and reservoir using the factory bolt.



109. Using a razor blade, or equivalent, remove the 90° quick connect fitting on the factory passenger side PCV hose.



110. Attach the 90° fitting onto the supplied 1/2" Cadbar hose. Connect the quick connect fitting to the passenger side valve cover and the other end of the hose to the barb on the supercharger nose.



111. Zip tie the Fuse holder on the Water Pump/ EVAP Harness onto the fuse box.



112. Open the fuse box and using a 10mm socket, attach the "Power Supply Wire" on the Water Pump/ EVAP Harness to the power terminal on the fuse box.



113. Route the "Intercooler Water Pump" end of the Water Pump/ EVAP Harness below the fuse box and around the washer fluid reservoir and plug it into the intercooler water pump.

114. Using a 10mm socket, remove the passenger side upper head lamp bolt. Attach the relay and screw the bolt back into the frame. **NOTE: Use a step drill to enlarge the hole on the relay tab until the bolt is able to pass through the hole.**



115. Route the ground strap and water pump connector downward through the frame. Remove the bolt securing the factory ground shown and mount the ground strap along with the factory ground in the original location. Connect the water pump.

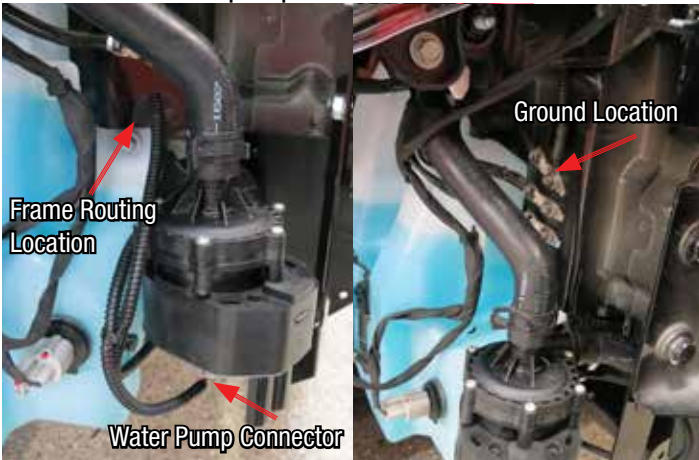

116. Connect the factory EVAP connector onto the "Engine Harness" end of the "Water Pump/EVAP Harness" and the "EVAP Solenoid" end onto the EVAP solenoid.



117. Using the supplied gaskets and (4) M6x20mm bolts, install the adapter to the supercharger nose as pictured below. Use the (4) bolts supplied in the throttle body box to attach the 103mm throttle body to the adapter. Insert the factory throttle body connector into the throttle body.

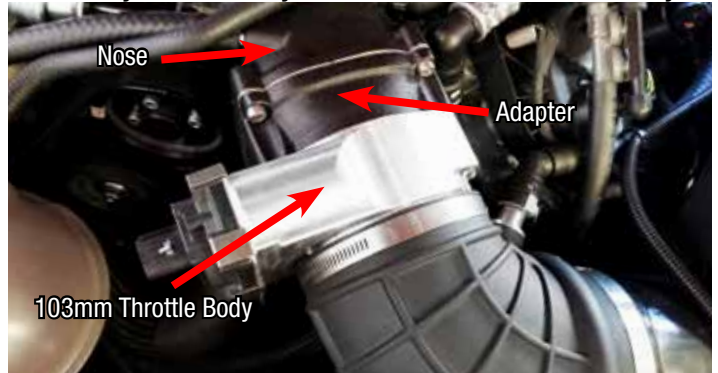

118. Assemble the MAF housing into the new air box using the provided M6 x 12mm bolts located in bag #5.



119. Remove the MAF sensor from the factory air box lid and reinstall into the new MAF housing using the provided pan head screws in bag #5.



120. Remove the rubber mounting grommet from the factory air box and install into the frame of the vehicle.



121. Using the provided worm clamps, secure the silicone intake elbow to new the air box. Then, lower the air box and tube assembly into place and secure with the factory bolt set aside earlier. Tighten the clamp holding the intake elbow to the throttle body. **TIP:** You may need to loosen the MAF housing to install the hose.



122. Install the conical air filter onto the MAF housing inlet using the provided clamp.



123. Install the air box lid using the six (6) 1/4"-20 cap screws located in bag #5.



124. Connect the brake aspirator to the lower fitting on the silicone elbow.



125. Connect the 90° fitting on the supplied driver side PCV hose to the driver side valve cover. Connect the other end to the fitting on the silicone elbow.



**126. PUMP BOOSTER INSTALLATION:** Remove the back seat by pressing on this tab underneath the seat cushion located on on each side. Lift up and then out.



127. Through the trunk, feed the booster pump cable underneath the driver side seat back as shown here.



128. Remove the spare tire cover and feed the cable underneath the carpet as shown.



129. Mount the booster module to the metal floor (as shown below) using the supplied self-tapping screws.

**OPTIONAL:** Clean the floor thoroughly with alcohol or soap and water and stick the module to the floor using double stick tape, or velcro.



130. Remove the rear trunk cover by removing the 4 thumb screws, 2 on each side.



131. Attach the ground wire to the 8mm screw pictured here. Once finished, reattach the rear trunk cover and and place the trunk floor back into position.



132. Under the back seat, disconnect the fuel pump cable located underneath the back seat on the driver side of the vehicle.



133. Connect the "T" cable as shown here. Reinstall the lower back seat.



134. Before replacing the shutters, the bottom section will need to be cut and removed to clear the LTR. Trim the shutter bracket as shown in the picture below. Replace the two (2) shutter bracket bolts into the crash guard and the two (2) clips on top that attaches to the core support. (**NOTE:** Rounding the corners isn't necessary but is safer to work with.)



135. Reconnect the fog lights and indicators, then replace the fascia onto the front of the car.

136. Reattach the lower splash shield and secure it with the stock fasteners.

137. Verify that the coolant petcock is closed, then refill the coolant system. (If necessary.)

138. Fill the supercharger surge tank with a 50/50 coolant and water mixture. **NOTE: Please see "How to Prime the Edelbrock E-Force Intercooler Systems" at the end of these instructions for detailed instructions.**

139. Turn the ignition key to the 'ON' position. Verify that water is flowing briskly through the recovery tank, then install the cap.

140. Once the installation has been verified, Prepare the coil covers for installation. Install the (8) M6 x 8mm decorative bolts onto the covers.

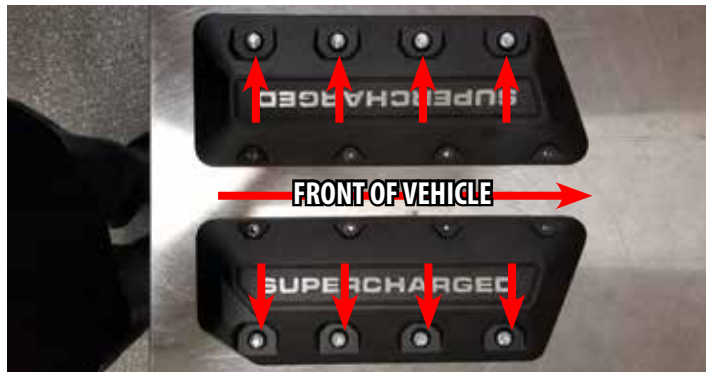

141. Place the evap in position for the coil covers. **TIP:** Place the bolts through the coil covers first, then feed the bolts into the evap bracket. Then thread the bolts into the supercharger coil cover brackets.

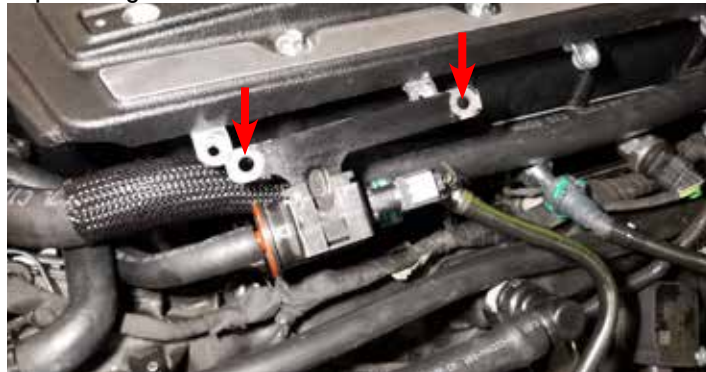

142. As a precaution, slice the 6" length of hose provided in this kit to wrap around the fuel line as pictured. This is to prevent the hose from rubbing on the edge of the coil cover. Secure with zip-ties.



143. Using the eight (8) M6 x 25mm bolts from the side cover kit, secure the side covers to the side cover brackets previously installed. **NOTE: Be sure to pass the 2 front bolts on the driver's side through the EVAP bracket before tightening.**



144. Repeat the same process for the passenger (right) side of the vehicle.



---

---

Congratulations on the installation of your new Edelbrock E-Force Stage II Supercharger System.

---

---

**CAUTION:** Check ADAS sensors as described under the "Important Warning" section in the front of this document.

### **How to Prime the Edelbrock E-Force Intercooler Systems.**



***The electric water pump used on this Edelbrock E-Force Supercharger System has a built-in micro-processor that will vary pump cycle speed when air bubbles are present in the system. If a significant amount of air is trapped in the system, the pump may cycle at a slower speed and pulsations are likely to occur resulting in poor cooling performance.***

For the best result, it is highly recommended to use a Radiator Cooling System Vacuum Purge and Refill Kit to properly evacuate the air from the intercooler system before filling with a 50/50 mixture of coolant and distilled water. If one is not available, the following procedure will be adequate.

1. Using the Lisle 24680 Spill-Free Funnel, or equivalent, secure the appropriate filler neck adapter to the surge tank.
2. Attach the funnel and fill with a 50/50 mixture of coolant and distilled water until the funnel is half full.
3. Turn the ignition to the ON position and listen for the pump's electric motor to cycle. Air bubbles will begin to purge from the system as the coolant level drops. Add coolant to the funnel as necessary. **NOTE: Do NOT let the coolant level in the funnel run empty as this may introduce air into the system.**
4. To build more pressure in the intercooler system, try squeezing the intercooler hoses while the pump is cycling. Building pressure in the system will help purge the trapped air from the intercooler system.
5. Cycle the ignition OFF and wait a few seconds for the pump to come to a stop.
6. Cycle the ignition ON again and repeat until the sound of the electric pump is continuous without any pulsation. **NOTE: During water pump start-up, it is normal for a slight pulsation to occur. Once the pump has reached its maximum cycle speed, no pulsations should be present.**
7. Periodically inspect the water pump flow after a few drive cycles and re-fill the intercooler system as necessary.
8. Several drive cycles may be required to completely purge the air from the intercooler system. During a drive cycle, the intercooler system will build up pressure as the supercharger temperature increases. Any residual air trapped in the system will gradually bleed out of the surge tank as the system reaches a pressure above 5psi.

***WARNING: Always avoid removing the surge tank cap when the engine is hot. The hot coolant is under pressure and may spray out causing burns.***



## Edelbrock Stage II Supercharger System 2018-19 Ford Mustang 5.0L Installation Instructions

---

### Email Edelbrock Your Stock Vehicle Calibration

**In the rare occurrence that you encounter an error message that reads “Calibration not supported” during the test flash procedure on page #9.**

- Put the car into Acc mode but do not start it.
- Connect the supplied PCM cable from the tuner to the OBD-II connector.
- Select PROGRAM VEHICLE, arrow over to UPLOAD STOCK, press SELECT and follow the prompts on the screen.
- If the upload fails, you will be asked to AUTO DETECT, press SELECT and follow the prompts on the screen.
- Once the stock calibration has loaded, disconnect the programmer from the OBD-II connector and connect it to your PC using the supplied USB cable.
- Open the SCT software and select the button on the lower left hand side that reads GET STOCK FILE FROM DEVICE. Follow the instructions on the screen.
- Once we have this file we can update the tune to work with your application, then we will e-mail you the custom tune which you may use until the release version is available. (This process can usually be completed within 1 to 2 business days)
- Download the new tune to the programmer using the directions received with the custom tune.
- Re-try the test flash procedure on page #9 using the custom tune.