



## **Edelbrock E-Force Supercharger**

**2015-2017 Dodge/Chrysler 5.7L and 6.4L HEMI**

**Part #1517, 15170, 15172, 151720**

**Pro Tuner Part #15171, 15174 (Reference Only)**



## **WARNING!**

*The supercharger bypass valve is factory installed and adjusted intended to be vacuum operated only. DO NOT move the solenoid actuator lever by hand or adjust the stop point. Moving the lever manually will damage the solenoid and the system will not function properly. Damage to the bypass assembly from manual movement will not be covered under manufacture warranty.*

# IMPORTANT CALIBRATION DETAILS

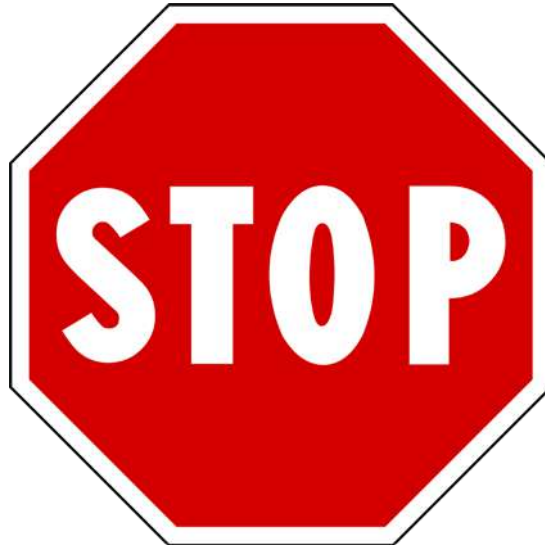

***USA CUSTOMERS ONLY:***

*In order to properly calibrate your vehicle for this supercharger kit, the ECM must be removed from the vehicle, packaged and shipped to Edelbrock. Your vehicle's computer will be modified and or flashed for supercharger kit compatibility. This kit contains a box for shipping the ECM to Edelbrock. (See ECM removal procedures on the following pages.)*

**NOTE:** *Affix the label to the package and drop it off at any UPS Store in your area.*

*The calibration process will take approximately 8-10 business days from the time your vehicles computers are received. To avoid unplanned vehicle down time, we recommend that the computers be shipped out BEFORE beginning the supercharger installation.*

# ECM Removal

The ECM is located under the hood on the passenger side of the vehicle. Follow these instructions carefully to remove, package and ship the ECM to Edelbrock.

1. Locate the battery in the trunk of the vehicle. Disconnect the negative battery terminal and isolate the negative cable so it does not come in contact with the battery terminal or body of the vehicle.

2. Accessing the ECM:

Dodge Challenger: Remove the two (2) push pins securing the plastic ECM cover. Remove cover and set aside.



Dodge Charger/Chrysler 300: Using a panel puller, remove the five (5) push pins securing the passenger side of the plastic cowl.



3. Using a 13mm socket, remove the bolt securing the ECM bracket to the frame.



4. Lift the ECM and disconnect the main harness connections by releasing the locking levers.



5. Using a 10mm socket, remove the two (2) nuts securing the mounting bracket to the ECM.



6. Remove the rubber bumper from the ECM and set aside.



7. Fill out the provided calibration label with customer and vehicle information and apply the label directly to the ECM. Place the ECM in the provided box with packing material so the ECM cannot move around in the box. Ship ECM to Edelbrock using the provided return shipping label.



## Edelbrock E-Force Supercharger System 2015-17 Dodge/Chrysler 5.7L and 6.4L Hemi

### Installation Instructions

#### INTRODUCTION

Thank you for purchasing the Edelbrock Hemi Supercharger System for various Chrysler/Dodge vehicles. The Edelbrock E-Force Supercharger System for the 2015-2017 Hemi utilizes Eaton's Gen VI R2650 TVS Supercharger rotors, featuring a four lobe design with a full 170° of twist for maximum flow, minimum temperature rise, quiet operation, and the reliability for which Eaton is known. The Edelbrock Supercharger is a complete system that maximizes efficiency and performance by minimizing air restriction into, and out of, the supercharger. This results in maximum airflow, with minimal temperature rise and power consumption. The supercharger housing itself is integrated into the intake manifold for a seamless design with minimal components, eliminating the possibility of vacuum leaks between gasket surfaces. The system also utilizes a front drive, front inlet configuration giving it the shortest, least restrictive inlet path on the market. The supercharger is inverted, expelling the air upward. Air pressure then builds in the plenum, before being pushed through the intercooler, oriented horizontally, above the supercharger outlet. After passing through the intercooler core twice, the air travels through the long runners, which route straight down into the cylinder head ports. This configuration allows for a compact package that can fit under the stock hood and cowl of the vehicles for which it was designed, without sacrificing runner length, or intercooler area. The E-Force supercharger features a uniquely styled plenum, and includes matching side covers. The Edelbrock supercharger provides neck snapping performance that is safe to operate on a completely stock engine.

#### TOOLS AND SUPPLIES REQUIRED

- Jack and Jack Stands OR Service Lift
- Panel Puller
- Ratchet and Socket Set including: 7mm, 8mm, 10mm (standard, deep and swivel), 11mm, 12mm (deep), 13mm, 15mm, 18mm, 21mm (deep), 24mm
- Wrenches including: 8mm, 18mm, 27mm
- 1/2" Breaker Bar
- Flat Blade & Philips Screwdrivers
- Compressed Air
- 90° Power Drill
- Allen Wrenches including: 1/4", 5mm, 6mm, 8mm
- Mechanic's Wire
- Chrysler Fuel Pump Lock Ring Remover/Installer #9340 OR Equivalent
- Side Cutters
- Dremel
- 3/8" Fuel Line Removal Tools
- Torque Wrench
- Needle Nose Pliers
- Pliers OR Hose Clamp Removal Tool
- Impact Wrench
- Blue & Green Loctite Retaining Compound or equivalent
- O-ring Lube
- Masking Tape
- Electrical Tape



**Edelbrock E-Force Supercharger System  
2015-17 Dodge/Chrysler 5.7L and 6.4L Hemi**

**Installation Instructions**

**IMPORTANT WARNINGS**

***Before beginning installation, use the enclosed checklist to verify that all components are present in the box then inspect each component for damage that may have occurred in transit.***



**WARNING:** *Installation of this supercharger will result in a significant change to the performance characteristics of your vehicle. It is highly recommended that you take some time to familiarize yourself with the added power, and how it is delivered, in a controlled environment. Take extra care on wet and slippery roads, as the rear tires will be more likely to lose traction, with the added power. It is never recommended to turn off your vehicles traction control system.*

***Proper installation is the responsibility of the installer. Improper installation will void all manufacturer's standard warranties and may result in poor performance and engine or vehicle damage.***

***Inspect all components for damage that may have occurred in transit before beginning installation. If any parts are missing or damaged, contact Edelbrock Technical Support, not your parts distributor.***

Due to the complexity of the Edelbrock E-Force Supercharging system, it is recommended that this system only be installed by a qualified professional with access to a service lift, pneumatic tools, and a strong familiarity with automotive service procedures. To qualify for the optional supplemental warranty, it is necessary to have this system installed by a Certified ASE Technician at a licensed business, Dodge/Chrysler Dealership, or an Authorized Edelbrock Installer. Failure to do so will void and/or disqualify any and all optional supplemental warranties offered with this system. Please contact the Edelbrock Technical Support department if you have any questions regarding this system and/or how your installer of choice will affect any warranty coverage for which your vehicle may qualify.

***Any previously installed aftermarket tuning equipment must be removed and the vehicle returned to an as stock condition before installing the supercharger.***

Any equipment that directly modifies the fuel mixture or ignition timing of the engine can cause severe engine damage if used in conjunction with the Edelbrock E-Force Supercharger System. This includes, but is not limited to: OBDII programmers, MAF sensors, adapters and any other device that modifies signals to and/or from the ECU. Aftermarket bolt-on equipment such as underdrive pulleys or air intake kits will also conflict with the operation of the supercharger and must be removed prior to installation. Use of any of these products with the E-Force Supercharger could result in severe engine damage.



**Edelbrock E-Force Supercharger System  
2015-17 Dodge/Chrysler 5.7L and 6.4L Hemi**

**Installation Instructions**

**IMPORTANT WARNINGS cont'd**



**91 octane or higher gasoline is required at all times. If your vehicle has been filled with anything less, it must be run until almost dry and refilled with 91 or higher octane gasoline twice prior to installation.**

**Any failures associated with not using premium 91 octane gasoline or higher, will be ineligible for warranty repairs.**

*It is recommended that you check the Edelbrock Tech Center Website for any updates to this installation manual. Please refer to the lower right hand corner to verify that you have the latest revision of this installation manual before beginning the installation.*

### INSTALLATION HARDWARE IDENTIFICATION GUIDE

*(Parts Are Not To Scale)*

BAG #1 - MANIFOLD HARDWARE				
Item	P/N	QTY.	Description	Torque Spec
1	36-4053	4	Bolt, Hex Flange, M6 x 40mm	N/A
2	36-1507	4	Bolt, Hex Flange, M6 x 16mm	N/A
3	36-1508	12	Bolt, Hex Flange, M6 x 30mm	8 ft/lbs
4	51-4093	1	Throttle Body O-Ring	N/A

(1x) - Throttle Body O-Ring *(Included, but not shown)*



BAG #2 - FEAD HARDWARE				
Item	P/N	QTY.	Description	Torque Spec
1	36-1559	1	M8 x 110mm Hex Flange Bolt	21 ft/lbs
2	36-1560	1	M8 x 100MM Hex Flange Bolt	21 ft/lbs
3	36-4029	1	M8 x 100 Socket Head Bolt	21 ft/lbs
4	36-4011	1	M8 x 25mm Hex Flange Bolt	18 ft/lbs
5	82-0120	1	M8 Washer	N/A

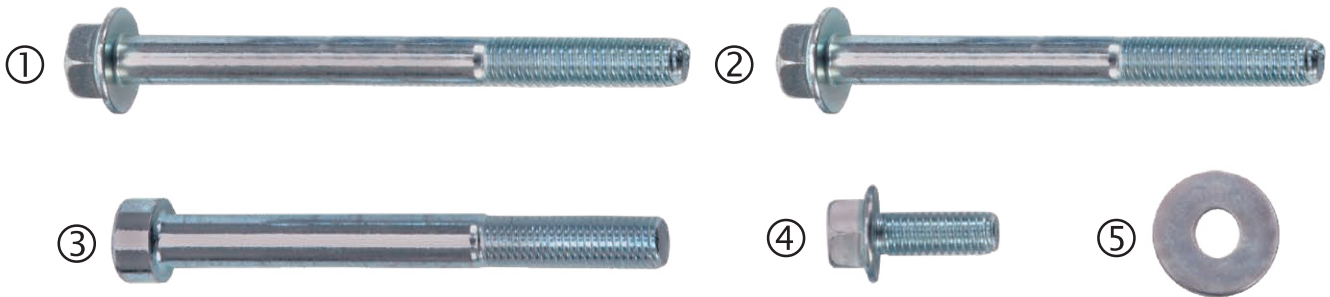



### INSTALLATION HARDWARE IDENTIFICATION GUIDE, Con't

(Parts Are Not To Scale)

BAG #3 - INTERCOOLER HARDWARE				
Item	P/N	QTY.	Description	Torque Spec
1	36-4018	2	M8 x 20mm Hex Flange Bolt	N/A
2	36-1552	2	M6 x 10mm Hex Flange Bolt	N/A
3	46-2155	8	3/4" Hose Clamp	N/A
4	46-2157	4	3/8" Hose Clamp	N/A
5	36-8572	2	M8 x 1.25 Hex Flange Nut	N/A
6	51-4126	1	Brass Coupler	N/A
7	52-4196	6	Plastic Push Pin	N/A



BAG #4 - DRILL/GUIDE HARDWARE				
Item	P/N	QTY.	Description	Torque Spec
1	36-4049	1	M14 x 1.5 x 100mm Bolt	N/A
2	51-7096	1	1/4" x 1/2" Dowel Pin	N/A
3	51-7046	1	15/64" Drill Bit	N/A
4	51-7047	1	.2500" Reamer	N/A
5	24-1591	1	Drill Fixture	N/A



**HOSE IDENTIFICATION GUIDE**

*(Parts Are Not To Scale)*

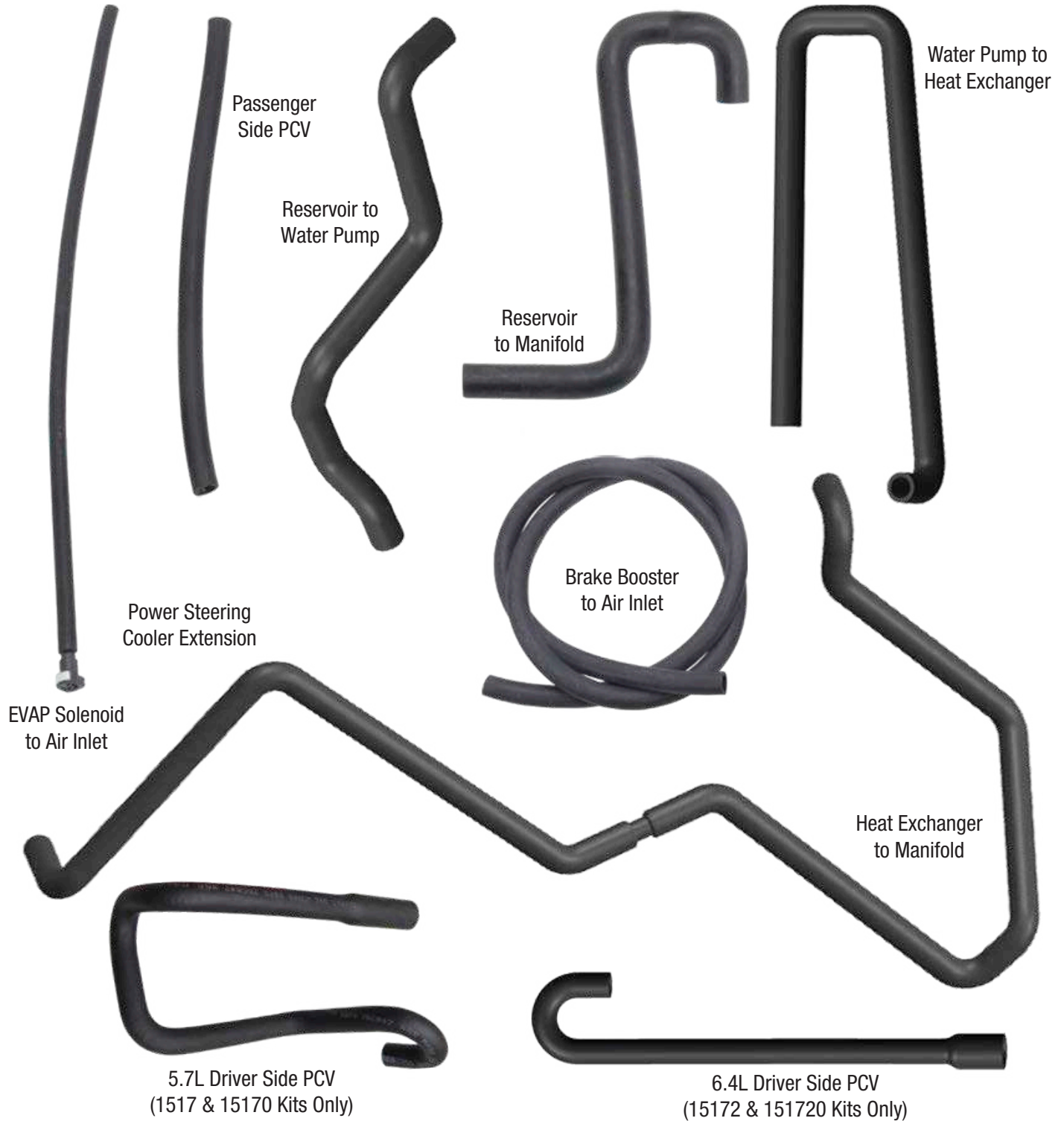

**HOSE ROUTING DIAGRAM**

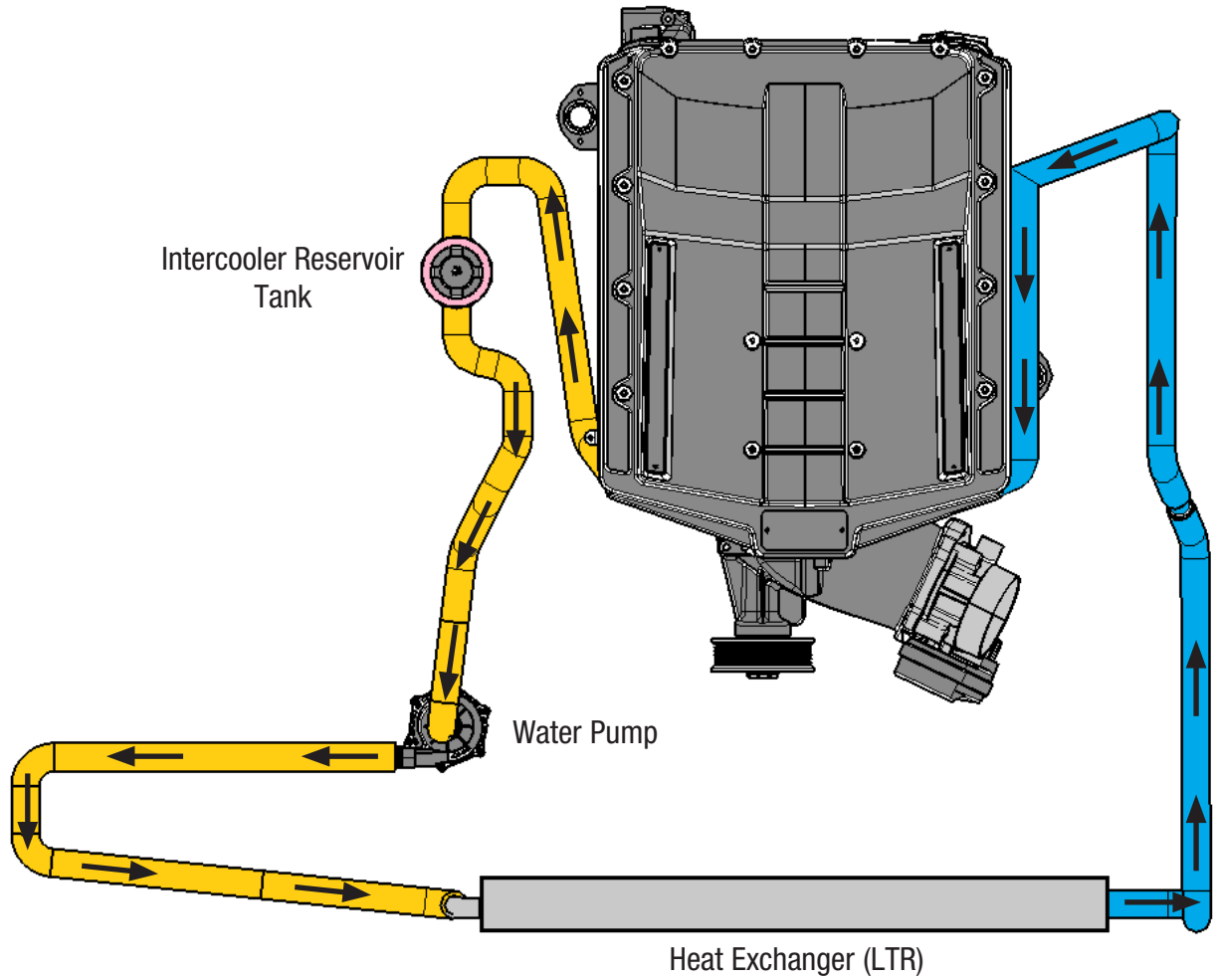

**WIRE HARNESS GUIDE**

*(Parts Are Not To Scale)*

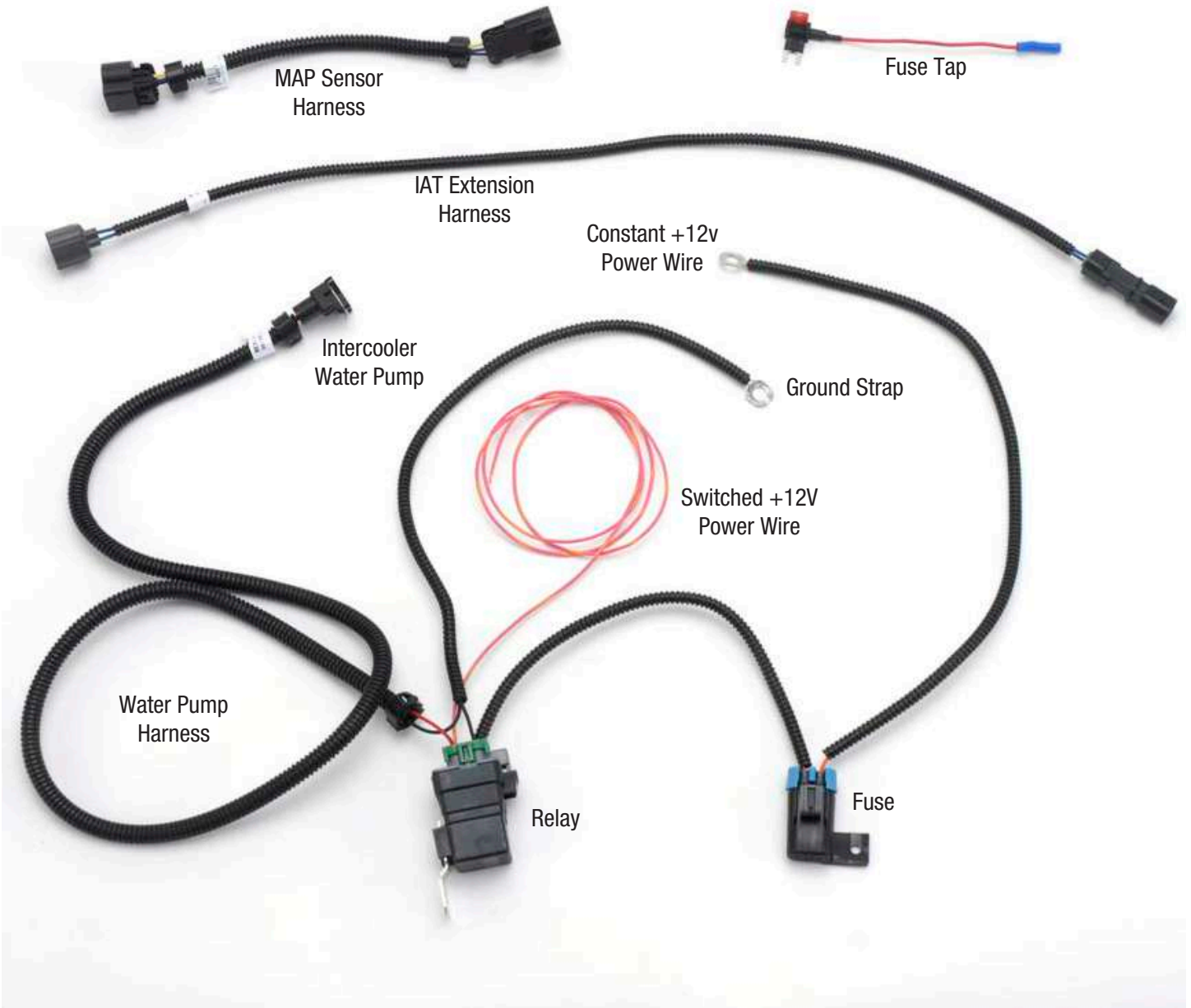

### Installation Instructions

#### Supercharger Installation

This installation guide is intended to cover multiple vehicle models and engine sizes. Some hardware included with this kit will not be used in certain applications. Depending on the vehicle year, images and procedures below may differ.

**CAUTION:** This installation requires replacement of the in-tank fuel pump. Before beginning the installation, make sure the fuel level of the vehicle is **below 5/8** of a tank to avoid fuel spillage in the vehicle.

**NOTE:** For vehicles driven competitively or in an aggressive manner, Edelbrock recommends the use of the following, colder, spark plugs:

**NGK IX Iridium 6619 LFR6AIX-11 - 2015-2016 w/ 5.7L only (not included)**

For normal street driving, stock equipped spark plugs, re-gapped to .028" are sufficient.

1. Reinstall the ECM by reversing the steps followed during removal. **DO NOT** reconnect the battery at this time. Install the included "Do Not Flash" cover onto the vehicle's OBDII port. **NOTE:** If you are beginning the installation without the ECM present, go back to this step once the supercharger installation is complete.



2. Vehicles equipped with 5.7L engines need to install the supplied fuel pump module at this time. **The fuel pump module installation procedure for 5.7L engines can be found at the end of this manual.** Vehicles equipped with 6.4L engines need to install the supplied fuel pump at this time. **For 6.4L engines, please follow the installation instructions supplied with the replacement fuel pump kit.**

3. Raise the front of the vehicle up with a service lift or equivalent.

4. Use a 10mm socket to remove the 4 bolts retaining the rear plastic splash shield and remove.

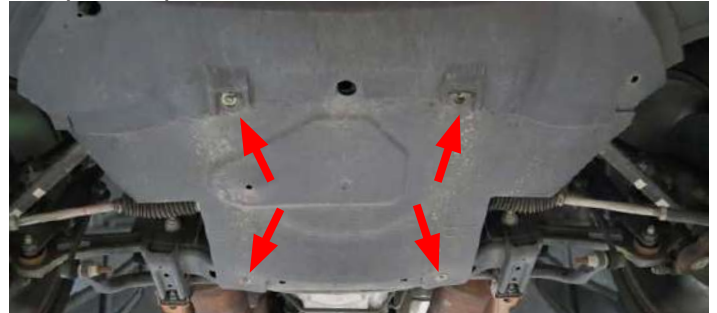

5. Using a panel puller, remove six (6) body pins from the front splash shield. Some vehicles are equipped with ten (10) body pins. If equipped, remove the three (3) screws attached to the air ducting on each side of the vehicle.

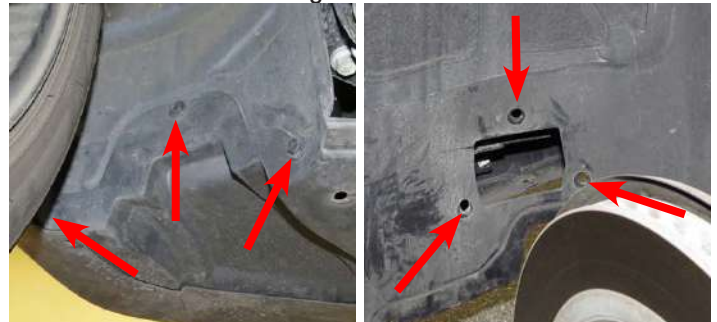

6. Using a 7mm socket, remove the nine (9) bolts retaining the splash shield to the front lip. Some vehicles are equipped with only seven (7) retaining bolts.

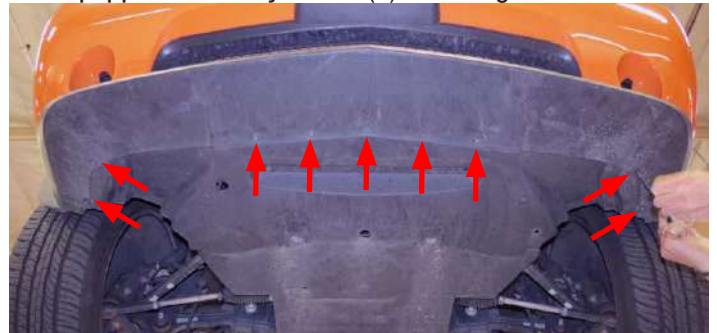

### Installation Instructions

7. Disconnect the lighting fixtures from the main harness. Some vehicle will have multiple harnesses for fog lights and side markers.



**NOTE:** Chrysler vehicles disregard this step.

8. Lift the plastic radiator shroud covers from underneath the hood latch and put them aside.



9. Dodge vehicles need to remove twelve (12) body pins, under the plastic radiator shroud, securing the fascia using a panel puller.

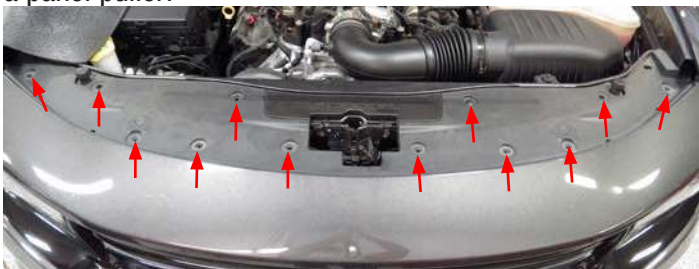

Chrysler vehicles need to remove seven (7) body pins securing the fascia using a panel puller.



10. Use a 10mm universal socket to remove the bolts at both top corners of the front fascia.



11. Use a panel puller to remove body pins securing the wheel well to the front fascia. Some vehicles use plastic rivets that need to be cut for removal. Pins are provided for reinstallation later.



12. Use a 10mm socket to remove the bolts behind each front wheel well.



### Installation Instructions

**NOTE:** Chrysler vehicles disregard this Step.

13. If equipped, use a 10mm deep socket to remove the nut inside each of the front wheel wells next to the headlight. **NOTE:** Remove front wheels to make nuts more accessible.



14. Carefully detach the sides of the front fascia and remove. Chrysler vehicles must also detach the top corners of the fascia.



15. Unplug the ambient temperature sensor and detach the harness from the radiator shroud using a panel puller to remove the panel pin.

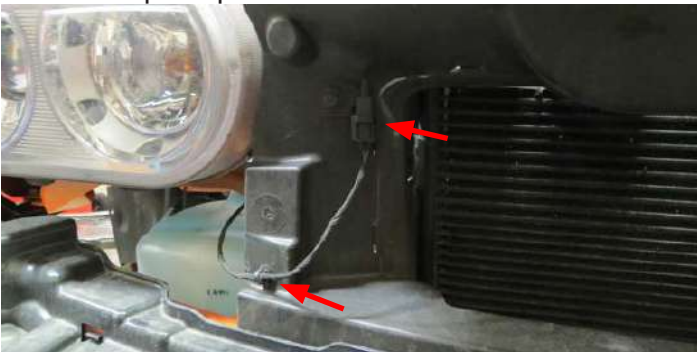

**NOTE:** Dodge Challengers are equipped with a front fascia supports and a front bumper absorber. Dodge Chargers and Chrysler 300s disregard steps 16 & 17.

16. Using a panel puller, remove three (3) body pins securing the front bumper absorber. Detach the locking tabs from the front bumper absorber and remove.



17. Using a panel puller, remove four (4) body pins securing the front fascia support and remove.



**NOTE:** Dodge Chargers and Chrysler 300s are equipped with a two piece radiator shroud. Dodge Challengers disregard step 18.

18. Using a panel puller, remove four (4) body pins securing the radiator shrouds and set aside.



### Installation Instructions

19. Remove any plastic covers from the engine by lifting them at the ends.

20. Place a drain pan below the petcock on the passenger side of the radiator then loosen the petcock and drain the coolant. Reinstall petcock when radiator is drained.



21. Remove the driver side PCV hose. Note that the 5.7L and 6.4L have different driver side PCV configurations.



22. Loosen the worm clamps securing the air inlet tube to the airbox and throttle body. Disconnect the engine harness from the IAT sensor and remove the air inlet tube. Using a 8mm socket, remove the bolt securing the stock airbox and remove the airbox.

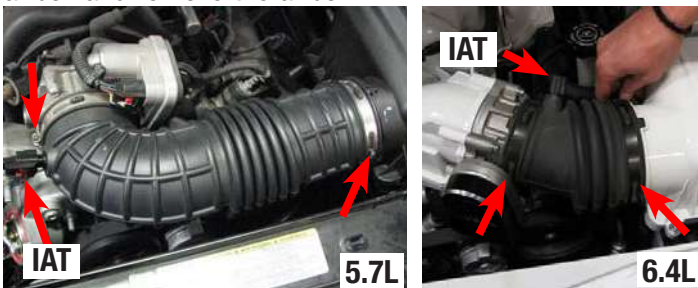

23. Pull the EVAP hose off the nipple on the solenoid mounted on the passenger side firewall. Then remove the hose from the front of the manifold. **NOTE:** The EVAP solenoid is placed lower under the fire wall on some applications. Later 5.7L applications may have the solenoid on the manifold. In this case, remove the harness, push pin and EVAP connections from the solenoid and mounting bracket. The Solenoid will be removed with the manifold and reused later.

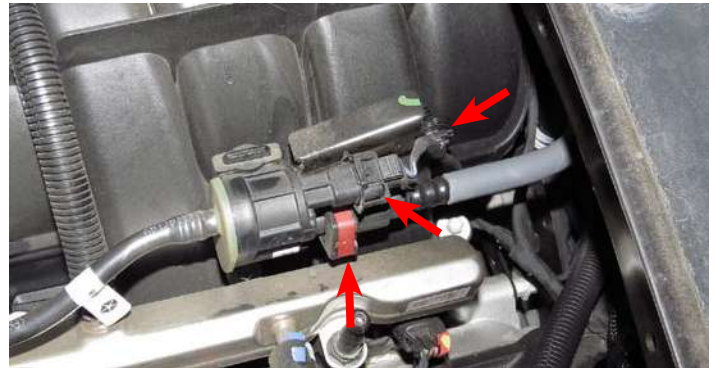

24. Disconnect the electric throttle control connector from the throttle body.





### Installation Instructions

25. Detach the quick release fuel line from the driver side fuel rail. **CAUTION: Fuel may be under pressure, cover with rag to prevent fuel from spraying.**



26. Unplug all eight (8) fuel injector connectors. Then use an 8mm socket to remove the ten (10) manifold bolts.

27. Unplug the MAP connector from the MAP sensor and the Active Runner Control connector from the back of the manifold. **NOTE: Some vehicles are not equipped with Active Runner Control.**



28. Remove the brake booster hose from the check valve on the brake booster.



29. Carefully remove the intake manifold and set aside.

30. Use a soft cloth to clean the intake flange of the cylinder heads, using caution to make sure dirt or debris do not fall into the intake ports. Once the intake flanges are cleaned, cover the ports with protective tape to prevent any foreign objects from falling into the ports.



**NOTE: The following step is only for vehicles with Active Runner Control. Disregard otherwise.**

31. Using electrical tape, cover up the Active Runner Control connector to prevent any water from contacting the connector terminals.



32. Using a 10mm socket, remove two (2) bolts securing each ignition coil. Remove the coils and note their order so that they can be reinstalled in the same order.

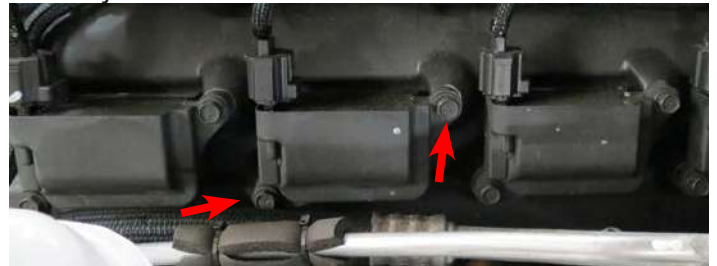

### Installation Instructions

33. Using a 5/8" spark plug socket, remove all 16 spark plugs. Inspect and replace them as needed, or replace them with colder plugs recommended before Step 1. Both stock and new plugs must be gapped to .028". Apply anti-seize to the threads of each plug and install. Torque each spark plug to 7.5-15 ft/lbs.

34. Reinstall the ignition coils in the same location they were originally and secure them with the stock bolts.

35. If equipped, remove the airbox shroud by removing two retaining pins on the top of the shroud and two (2) on the side of the shroud.

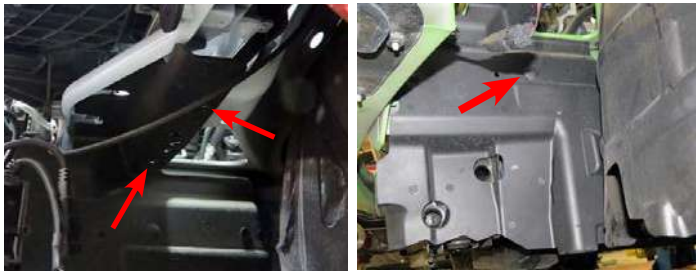

36. Using mechanic's wire or equivalent, securely hang the A/C condenser to the vehicle. Using an 8mm socket, remove four (4) bolts securing the A/C condenser to the radiator assembly.



37. Remove all radiator hoses from the radiator if not already done so. Remove the fan harness and clip from the radiator assembly. Using a 13mm socket, unbolt the radiator support brace.



38. With the help from an assistant, carefully lower the radiator assembly and set aside.



39. For vehicles equipped with an oil cooler, remove the oil cooler hose and fitting from the front of the water pump. This hole will be plugged in step 104 with the provided 3/8" pipe plug after the cooling system is refilled.

40. Use a 3/8" drive breaker bar to loosen the tension on the belt tensioner and remove the drive belt.



### Installation Instructions

**NOTE:** The following step is for vehicles equipped with manual transmissions only. Automatic transmission vehicles can remove the crank bolt using an impact gun or equivalent.

41. Using a 10mm socket, remove the flywheel dust cover. Insert an Allen key or equivalent jamming tool into the flywheel. Place a rag in between the tool and transmission to protect the transmission surface.



42. Using a 21mm socket and breaker bar, remove the factory crank bolt. Using the supplied crank bolt, install the drilling guide with the flat side facing outwards. Position drilling bushing in a comfortable position for drilling.

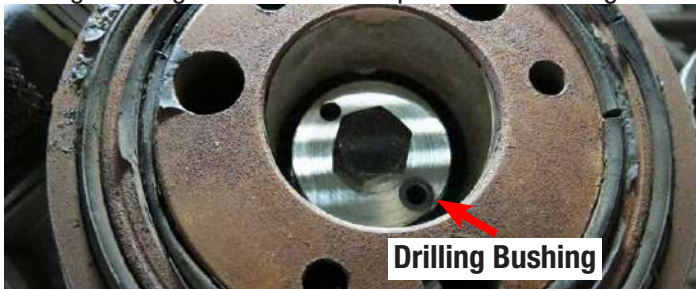

43. Mark the supplied drill bit 1.3" from the end of the tip with masking tape. Using the drilling bushing as a guide, drill into crank until the tape mark on the drill bit meets the drilling guide.



44. Use compressed air to clean out any debris present from the drilling. **CAUTION:** Use extreme caution when doing this to make sure debris does not get past the seal into the crankcase, as this will require a great deal of disassembly to correct or could cause severe engine damage if ignored.

45. Loosen the guide bolt and rotate the guide to line up the reaming hole with the hole drilled. Use the back of the supplied reamer to center the reaming hole to the drilled hole. Tighten down the crank bolt to secure the guide and ream the hole with the supplied reamer.

46. Remove the drilling guide and clean out the hole in the crank with compressed air. Apply Green Loctite (*Red Loctite can be used if Green Loctite is not available*) to the supplied crank pin and tap it into the hole in the crank.



47. Using a 21mm socket, reinstall the factory crank bolt and torque to 127 ft/lbs. Remove the tool used to jam the flywheel and reinstall the dust cover if applicable.

48. Using a 16mm socket, remove the belt tensioner. **NOTE:** Tensioner must be removed to mount the supplied idler bracket.

### Installation Instructions

49. Using a 13mm socket, remove the upper left bolt from the idler pulley assembly and the water pump bolt directly above the belt tensioner.



50. Using the short spacer and the bolts from Bag #2, loosely mount the idler bracket to the two bolt hole locations from the previous step. Using the long spacer and M6 x 110mm bolt from Bag #2, secure the bracket to the third bolt location; the provision on the cylinder head above the idler pulley bolt removed from Step 49. Torque all bolts to 21 ft/lbs.

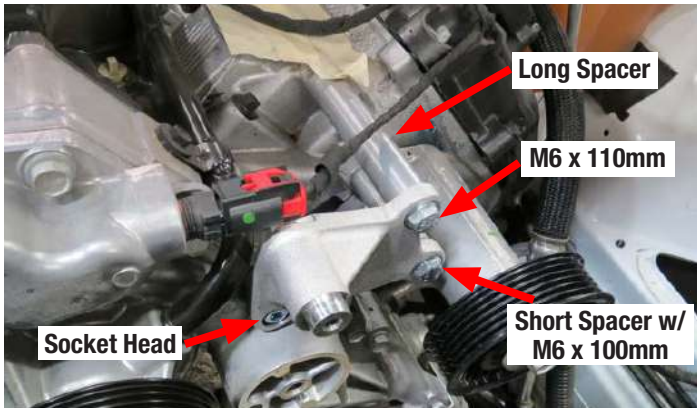

51. Using a 13mm socket, replace the grooved pulley on the factory idler bracket with the supplied 90mm grooved pulley. Make sure to apply Blue Loctite, or equivalent, to the threads of the factory bolt before installing. Torque bolt to 18 ft/lbs.

52. Using a 16mm socket, install the supplied upgraded belt tensioner using the factory bolt. Torque to 32 ft/lbs.

53. Install the supplied 76mm idler pulley to the idler bracket using the M8 x 25mm bolt and M8 washer from Bag #2. Make sure to apply Blue Loctite, or equivalent, to the threads of the bolt before installing. Torque bolt to 18 ft/lbs.



54. Use a 3/8" Fuel Line Removal Tool to detach the fuel input line from the factory hard line near the firewall on the passenger side. Attach the 90° end of the supplied fuel input line to the factory hard line.



55. Apply blue thread lock fluid onto the threads of the eight (8) M6 x 12mm SHCS bolts from the side cover kit and loosely screw on the side cover brackets to the underside of the supercharger lid.



### Installation Instructions

56. For proper bracket alignment, test fit the side covers onto the brackets using eight (8) M6 X 25mm bolts from the side cover kit. Align the side covers to the supercharger lid then fully tighten the bracket bolts. **Once all brackets are aligned and tightened, remove the side covers.**



57. Remove the tape covering the intake ports of the heads and inspect the area to ensure that no residue remains on the flanges. Remove the plastic film from the supercharger ports if not already done so. Transfer the factory intake manifold gaskets to the supercharger runners.



58. With the help of an assistant or a cherry picker, lift the supercharger into the engine bay. Use the intake bolt holes and injector bores to achieve the best alignment possible between the engine and the supercharger. **NOTE:** Ensure that all eight (8) O-ring gaskets are in place before proceeding.



59. Use a 10mm universal socket to install eight (8) M6 x 30mm intake manifold bolts from Bag #1 following the sequence shown below. Torque all bolts to 8 ft-lbs in the same order.

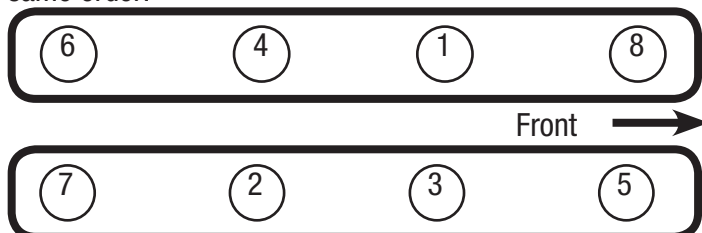

60. Install the supplied drive belt using the belt routing diagram below.

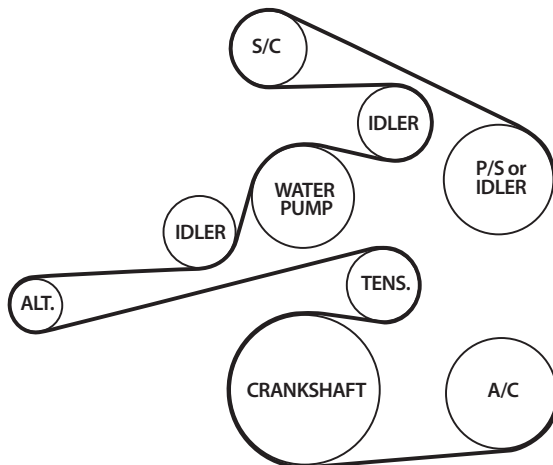



## Edelbrock E-Force Supercharger System 2015-17 Dodge/Chrysler 5.7L and 6.4L Hemi

### Installation Instructions

61. Apply O-ring lube to the O-rings of the supplied fuel rail fittings. Install the two straight fittings on the rear provisions of the rails. Install the 180° fitting on the front provision of the passenger side rail and the plug in the front provision of the driver side rail.

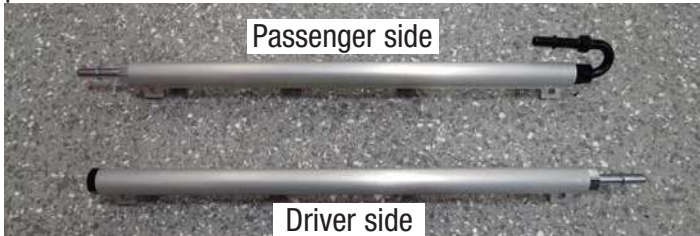

62. **5.7L Engines ONLY:** Apply O-ring lube to the upper O-rings of the supplied fuel injectors, then install them into the fuel rails with the connectors oriented away from the supercharger.

**6.4L Engines ONLY:** Apply silicone O-ring lube to the O-rings on the upper end (fuel inlet) of the provided fuel injectors, then install the provided fuel injector cups onto the upper end of the fuel injectors. Apply silicone O-ring lube to the O-rings on the fuel injector cups, then install the injector/cup assembly into the fuel rails with the connectors oriented away from the rails.

63. Apply O-ring lube to the lower O-rings of the fuel injectors, then install the driver side fuel rail by sliding the injectors down into the manifold provisions and applying pressure until the mounting holes in the rails line up with the manifold.

64. Attach the supplied fuel rail crossover line to the straight fitting on the passenger side fuel rail.

65. Route the fuel crossover hose behind the manifold and around the fuel supply line as you install the passenger side fuel rail. Connect the fuel crossover to the straight fitting on the driver side rail. Connect the fuel supply line to the 180° fitting on the front of the passenger side rail.



66. Using a 10mm socket, secure the fuel rails to the manifold using four (4) M6 x 40mm bolts supplied in Bag #1. Remove the oil fill cap from the stock intake manifold and install it on the supercharger. Reconnect all eight (8) fuel injector connectors.



67. Attach the supplied brake booster hose to the check valve and route the hose to the driver side air inlet located on the supercharger snout.



68. Attach the supplied passenger side PCV hose to the front fitting on the passenger side of the air inlet and then to the PCV fitting as shown.



### Installation Instructions

**Step 69 is for vehicles with the EVAP solenoid located on the passenger side fire wall of the vehicle:**

69. Install the supplied EVAP hose to the EVAP solenoid. Route the hose along the passenger side valve cover and connect the quick connect fitting to the rear barb on the manifold as shown.



**Steps 70-71 are for vehicles with the EVAP solenoid located on the intake manifold:**

70. Remove the solenoid from the factory intake manifold bracket. Using a razor blade, cut and remove the plastic hard-line from the solenoid.



71. Install the supplied EVAP mounting bracket in the location below with the factory coil bolt. Reconnect the engine harness and EVAP line to the solenoid. Connect the supplied 5/16" hose to the solenoid and route the other end under the supercharger lid to the 5/16" barb shown in step 69.



72. Attach the water pump to the water pump bracket by sliding the rubber isolator over the pump motor then onto the bracket.

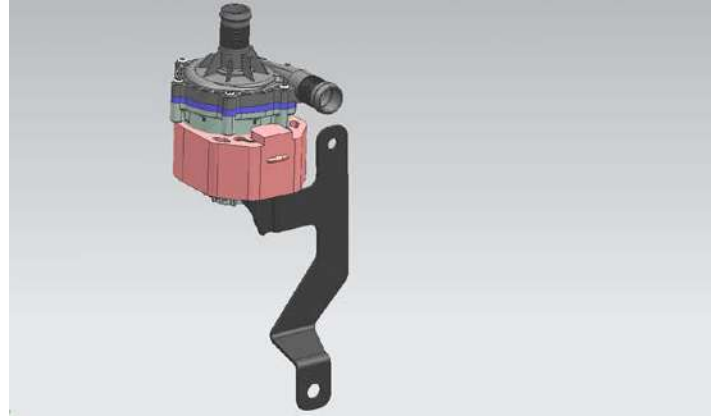

73. Mount the water pump/bracket assembly to the passenger side frame rail using the supplied M8 x 20mm bolts and M8 nuts from Bag #3. The pump will mount just below the radiator hose in front of the alternator.

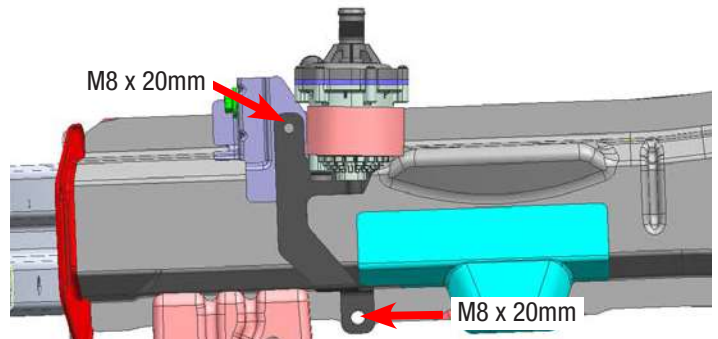

74. **2015+ Model Year Chargers Only:** Using the factory hardware, replace the existing bracket located under the passenger side headlight with the provided bracket to allow sufficient clearance for intercooler hoses.



### Installation Instructions

75. Route the straight end of the Water Pump to LTR hose under the passenger side head light towards the water pump. On 2015+ Chargers the hose will route through the bracket installed during the previous step. Connect the hose to the outlet of the water pump and secure with a hose clamp from Bag #3. **NOTE:** The other end of the hose will connect to the Low Temp Radiator (LTR) later.

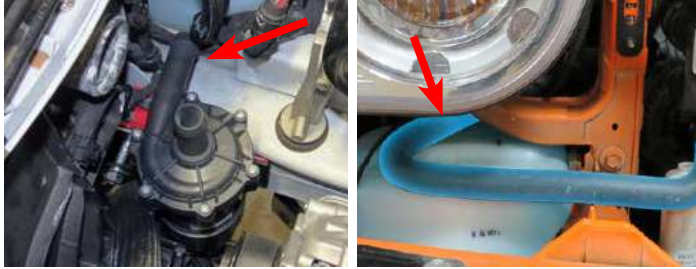

76. For vehicles equipped with an oil cooler, install the supplied thermostat housing and trim off the highlighted portion of the hose shown below. Secure the hose to the new housing with the factory clamp.



77. Reinstall the radiator assembly using the factory bolts. Reinstall the upper and lower radiator hoses.

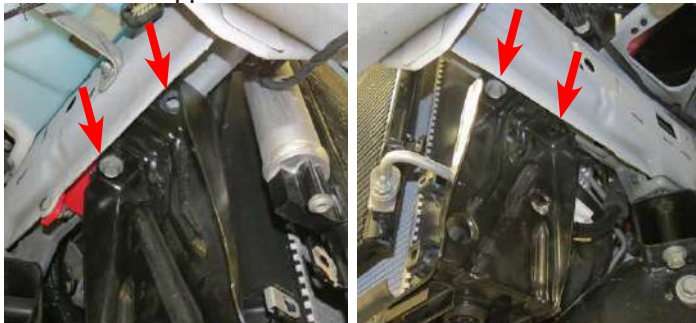

78. Using side cutters or equivalent, cut off the condenser support cables installed earlier.

79. Position the supplied low temperature radiator (LTR) in front of the AC condenser. Lineup the mounting holes on the LTR and A/C condenser. Secure the LTR and A/C condenser to the radiator assembly with the factory bolts.

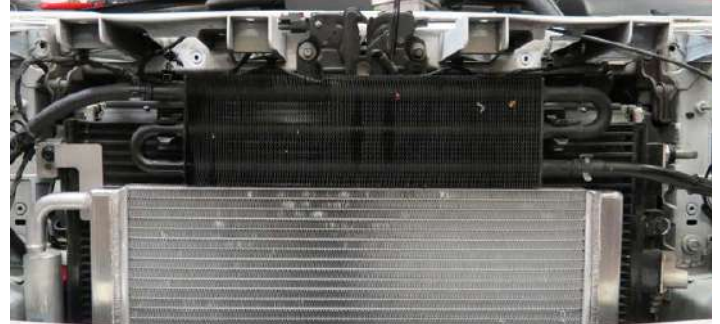

80. If applicable, reinstall the airbox shroud using the factory hardware.

81. Using the factory coil bolts, mount the intercooler reservoir bracket between the second and third coil on the passenger side.



82. Attach the intercooler reservoir to the supplied bracket using the two M6 x 10mm bolts supplied in Bag #3.





### Installation Instructions

83. Attach the Reservoir to Water Pump hose to the front provision of the intercooler reservoir and secure it with a hose clamp from Bag #3. Route the hose down to the inlet of the water pump and secure it with a hose clamp.



84. Install the Manifold to Tank hose between the supercharger and tank. Secure both ends of the hose with hose clamps from Bag #3.



85. Connect the previously install Water Pump to LTR hose to the LTR and secure with a hose clamp from Bag #3. Apply six (6) inches of convolute sleeve to the LTR hose and secure with electrical tape or equivalent.

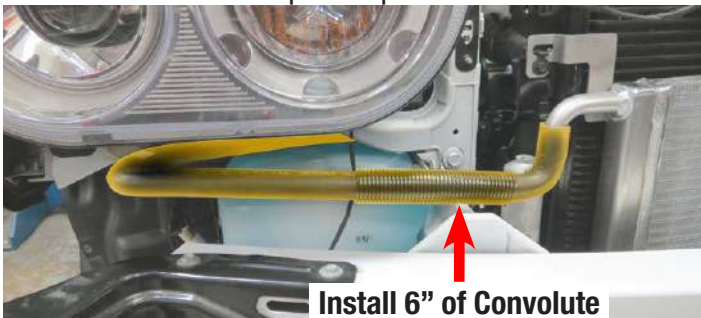

86. Install the LTR to Manifold hose onto the driver side intercooler fitting and secure with a hose clamp from Bag #3. Route the hose down towards the LTR making sure the hose is routed under the A/C lines as shown. **NOTE:** Use caution when routing the hose to ensure it will not contact sharp edges, the exhaust manifold or drive belt pulleys.



87. Attach the LTR to Manifold hose to the LTR and secure with a hose clamp from Bag #3. Apply two (2) pieces of convolute sleeve, about three (3) inches each, to the LTR hose as shown and secure with electrical tape or equivalent.

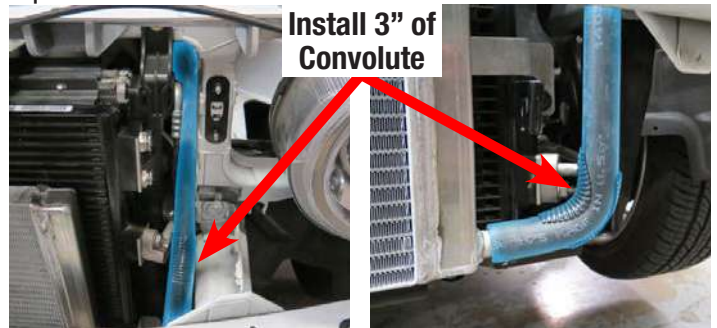

88. Use an 8mm socket to remove the throttle body from the stock manifold. In the orientation shown below, install the throttle body on the supercharger manifold using the supplied paper gasket and four (4) M6 x 40mm bolts from Bag #1. (See note on next page)





# Edelbrock E-Force Supercharger System 2015-17 Dodge/Chrysler 5.7L and 6.4L Hemi

## Installation Instructions

**NOTE:** If using the stock 80mm throttle body, use RTV silicone to fill the two (2) holes at the top of the throttle body mounting surface and apply the provided gasket. Note the gasket orientation shown below.

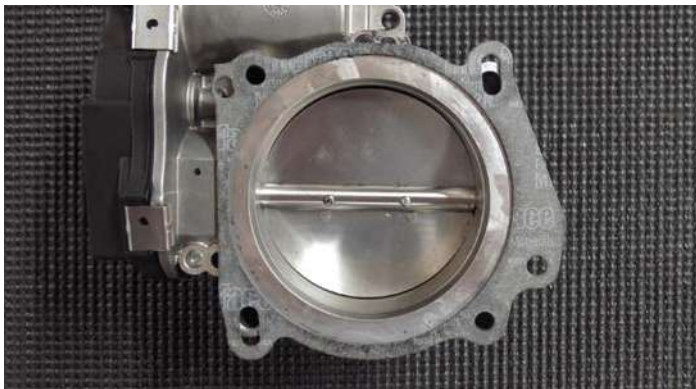

89. Reconnect the factory throttle body connector to the throttle body.

90. Replace the factory air filter with the supplied green air filter. Using the factory airbox mounting hardware, reinstall the factory airbox.



91. **5.7L Engines:** Install the provided silicone elbow onto the throttle body and the airbox lid. Secure with the provided worm clamps. **NOTE:** The silicone elbow should be loosely installed before securing the airbox lid to the lower half.



**6.4L Engines:** Use the factory rubber elbow and clamps. **NOTE:** The IAT sensor should be removed and the hole plugged with the included plastic plug.



92. Install the driver side PCV hose onto the fitting next to the oil fill cap and then to the PCV fitting on the airbox. Be sure the hose does not kink.

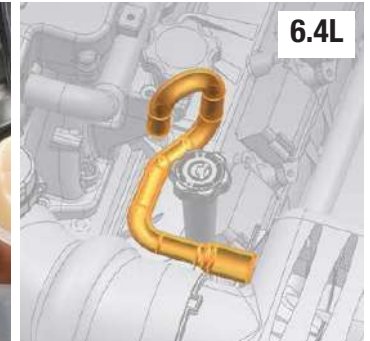

### Installation Instructions

93. Connect the supplied MAP extension harness onto the factory MAP connector, then connect the MAP extension harness to the MAP sensor located on the rear driver side of the manifold.



94. Connect the IAT extension harness to the stock IAT connector. Route the IAT extension harness behind the manifold and connect to the IAT sensor located on the rear passenger side of the manifold.



**NOTE:** Steps 95-97 are for vehicles equipped with the fuse box shown below. Disregard and proceed to Step 98 if vehicle is equipped with a different fuse box.



95. Open the fuse box and remove the fuse from location 6 (Ignition Coils/Injection 25A - See reverse of fuse box cover), this will be the front most fuse on most applications. Install that fuse in the bottom slot of the supplied fuse tap and the supplied 10 amp fuse in the top slot. Install the fuse tap in the slot previously occupied by the stock fuse.



96. Use a 1/8" drill bit to drill a hole in the plastic rivet closest to the passenger side strut tower. Feed the bare wire extending from the water pump harness through the hole and insert it into the butt connector on the fuse tap. Crimp the butt connector firmly to secure the connection.

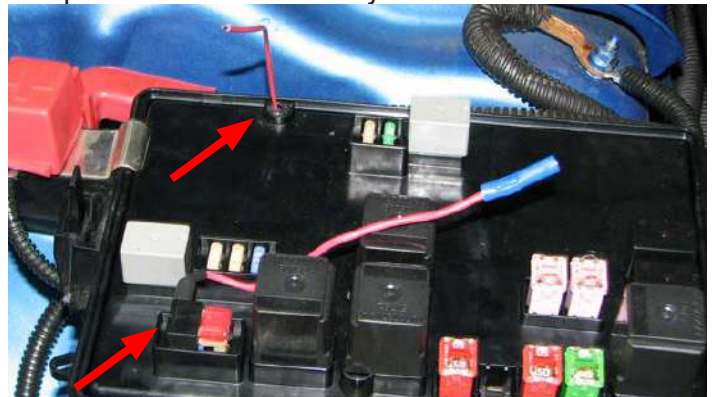

97. Tilt the fuse box up and remove the right nut. Mount the water pump harness relay on the protruding stud and reinstall the nut. Proceed to Step 100.





## Edelbrock E-Force Supercharger System 2015-17 Dodge/Chrysler 5.7L and 6.4L Hemi

### Installation Instructions

**NOTE:** Steps 98-100 are for vehicles equipped with the fuse box shown below.



98. Open the fuse box and remove the fuse from location 39 (Power Steering / AC Clutch 10A - See reverse of fuse box cover). Install both supplied 10 amp fuses in the fuse tap. Install the fuse tap in the slot previously occupied by the stock fuse.



99. Feed the fuse tap wire on the Water Pump harness through the opening of the fuse box as shown. Using crimpers, connect the fuse tap wire to the butt connector installed on the fuse tap.



100. Mount the relay and fuse holder on the water pump harness on the metal tab with a wire tie.

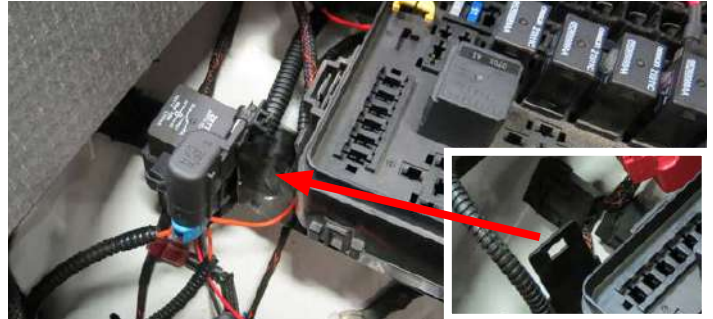

101. Route the water pump connector down to the electric water pump and connect it to the water pump.

102. Route the Power (+) wire on the water pump harness over to the power stud on the fuse box. Remove the nut, slide the ring connector over the stud and reinstall the nut. Route the Ground (-) wire on the water pump harness over to the grounding stud on the passenger side strut tower. Remove the nut, slide the ring connector over the stud and reinstall the nut.



103. Remove the intercooler reservoir cap and fill the system with a 50/50 blend of water and antifreeze. **Please refer to "How to Prime the Edelbrock E-Force Intercooler System" on page #28.**



# Edelbrock E-Force Supercharger System 2015-17 Dodge/Chrysler 5.7L and 6.4L Hemi

## Installation Instructions

104. Fill the cooling system with appropriate 50/50 blend of coolant until coolant leaks out of the bleeder hole. Immediately install the provided 3/8" pipe plug. Continue filling the coolant reservoir until the level reaches the Cold Fill level.



105. Vehicles with power steering cooler that installed an extension hose should check fluid levels and refill if necessary.

**NOTE:** The following step is for vehicles equipped with two piece radiator shrouds. Disregard otherwise.

106. Test fit the radiator shrouds and trim as needed in order to clear the intercooler and power steering cooler hoses (if equipped). Install radiator shrouds using the factory hardware.

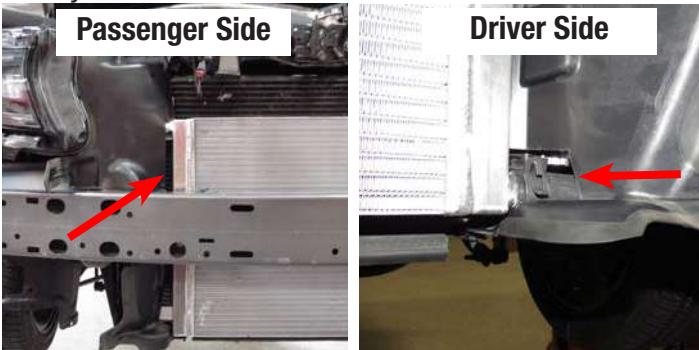

**NOTE:** Steps 107-110 are for vehicles equipped with a front fascia support. Disregard otherwise.

107. Remove both rubber strips from the front fascia support.

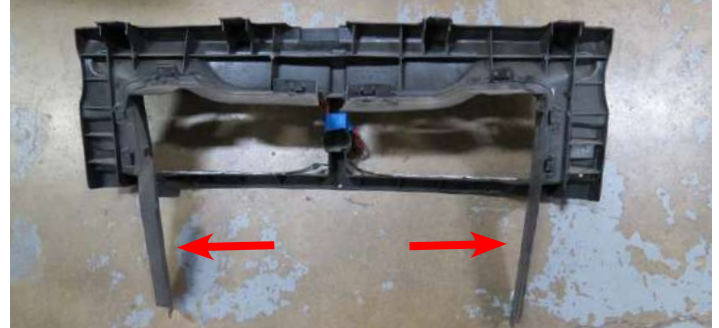

108. Using a Dremel or equivalent, grind down the lower tab on the passenger side of the front fascia support.



109. Reinstall the front fascia support and the front bumper absorber using the factory hardware.

110. Using a Dremel, or equivalent, trim the driver side of the front fascia to clear the LTR hose. Verify that the LTR hose clears the fascia before reinstalling the front fascia.





## Edelbrock E-Force Supercharger System 2015-17 Dodge/Chrysler 5.7L and 6.4L Hemi

### Installation Instructions

111. Reinstall the front fascia by reversing the disassembly procedure.

112. Reconnect the lighting harness connectors.

113. Reconnect the Negative battery terminal if not already done so.

114. Turn the ignition on but do not start the vehicle. Check for any fuel, coolant or power steering fluid leaks (if applicable). If leaks are present, shut the ignition off immediately and repair leaks before continuing.

115. Start the engine and let the it come up to operating temperature, then shut it off and recheck all fluid levels. Top fluids off if necessary.

116. Before installing the side covers onto the supercharger, install the four (4) M6 x 8mm bolts from the side cover hardware kit to the lower holes on each cover.

117. Using the eight (8) M6 x 25mm bolts from the side cover kit, secure the side covers to the brackets previously installed during steps 55 & 56.



Congratulations on the successful installation of your new Edelbrock E-Force Supercharger System.



### Installation Instructions

The Fuel Pump replacement procedure is only for 5.7L vehicles. Disregard if your vehicle is not a 5.7L.

**NOTE:** Before beginning the installation of the supplied fuel pump, make sure the fuel level of the vehicle is below 5/8 of a tank to avoid fuel spillage in vehicle.

The fuel pump module must be installed in the same position as removed. This step must be performed correctly to prevent the float from contacting the side of the fuel tank.

118. Install the supplied fuel pump by removing the rear lower seat cushion. Push the rear lower seat cushion up and back to remove.

119. Fold back the foam pad covering the fuel pump rubber access plug. Remove the rubber access plug using a panel tool and disconnect the electrical connector from the fuel pump module.



**NOTE:** Prior to removing the fuel pump module, remove any dirt or debris around the fuel tank opening with compressed air or shop vac.

120. Position the lock ring remover/installer (Chrysler #9340) or equivalent into the notches on the outside edge of the lock ring. Attach a 1/2" drive breaker bar to the lock ring remover/installer and rotate the breaker bar counterclockwise to remove.



121. Lift the fuel pump module up to access the lower power connections. Disconnect the connectors from under the top of the fuel pump module and set aside.



122. Press the quick connect release tab on the fuel supply line and remove. Now, disconnect the lower fuel pump module electrical connector and fuel return lines.

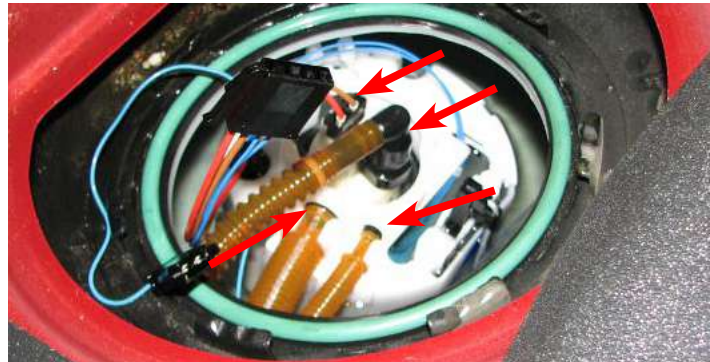

123. Carefully turn the fuel pump module on its side to drain the remaining fuel from the bottom reservoir and remove from the vehicle.

**NOTE:** An alignment arrow is located on top of the fuel pump module to help align it during installation.

124. Remove the rubber O-ring seal and discard. Replace with the supplied rubber O-ring seal. Then lower the supplied replacement fuel pump module into the fuel tank and connect the fuel return lines.

125. Connect the fuel supply line and lower fuel pump module electrical connector. Now connect the electrical connectors at the top of the fuel pump module and lower the fuel pump module into position.



## Edelbrock E-Force Supercharger System 2015-17 Dodge/Chrysler 5.7L and 6.4L Hemi

### Installation Instructions

#### How to Prime the Edelbrock E-Force Intercooler Systems.



*The electric water pump used on this Edelbrock E-Force Supercharger System has a built-in micro-processor that will vary pump cycle speed when air bubbles are present in the system. If a significant amount of air is trapped in the system, the pump may cycle at a slower speed and pulsations are likely to occur resulting in poor cooling performance.*

For the best result, it is highly recommended to use a Radiator Cooling System Vacuum Purge and Refill Kit to properly evacuate the air from the intercooler system before filling with a 50/50 mixture of coolant and distilled water. If one is not available, the following procedure will be adequate.

1. Using the Lisle 24680 Spill-Free Funnel, or equivalent, secure the appropriate filler neck adapter to the surge tank.
2. Attach the funnel and fill with a 50/50 mixture of coolant and distilled water until the funnel is half full.
3. Turn the ignition to the ON position and listen for the pump's electric motor to cycle. Air bubbles will begin to purge from the system as the coolant level drops. Add coolant to the funnel as necessary. *NOTE: Do NOT let the coolant level in the funnel run empty as this may introduce air into the system.*
4. To build more pressure in the intercooler system, try squeezing the intercooler hoses while the pump is cycling. Building pressure in the system will help purge the trapped air from the intercooler system.
5. Cycle the ignition OFF and wait a few seconds for the pump to come to a stop.
6. Cycle the ignition ON again and repeat until the sound of the electric pump is continuous without any pulsation. *NOTE: During water pump start-up, it is normal for a slight pulsation to occur. Once the pump has reached its maximum cycle speed, no pulsations should be present.*
7. Periodically inspect the water pump flow after a few drive cycles and re-fill the intercooler system as necessary.
8. Several drive cycles may be required to completely purge the air from the intercooler system. During a drive cycle, the intercooler system will build up pressure as the supercharger temperature increases. Any residual air trapped in the system will gradually bleed out of the surge tank as the system reaches a pressure above 5psi.

***WARNING: Always avoid removing the surge tank cap when the engine is hot. The hot coolant is under pressure and may spray out causing burns.***