

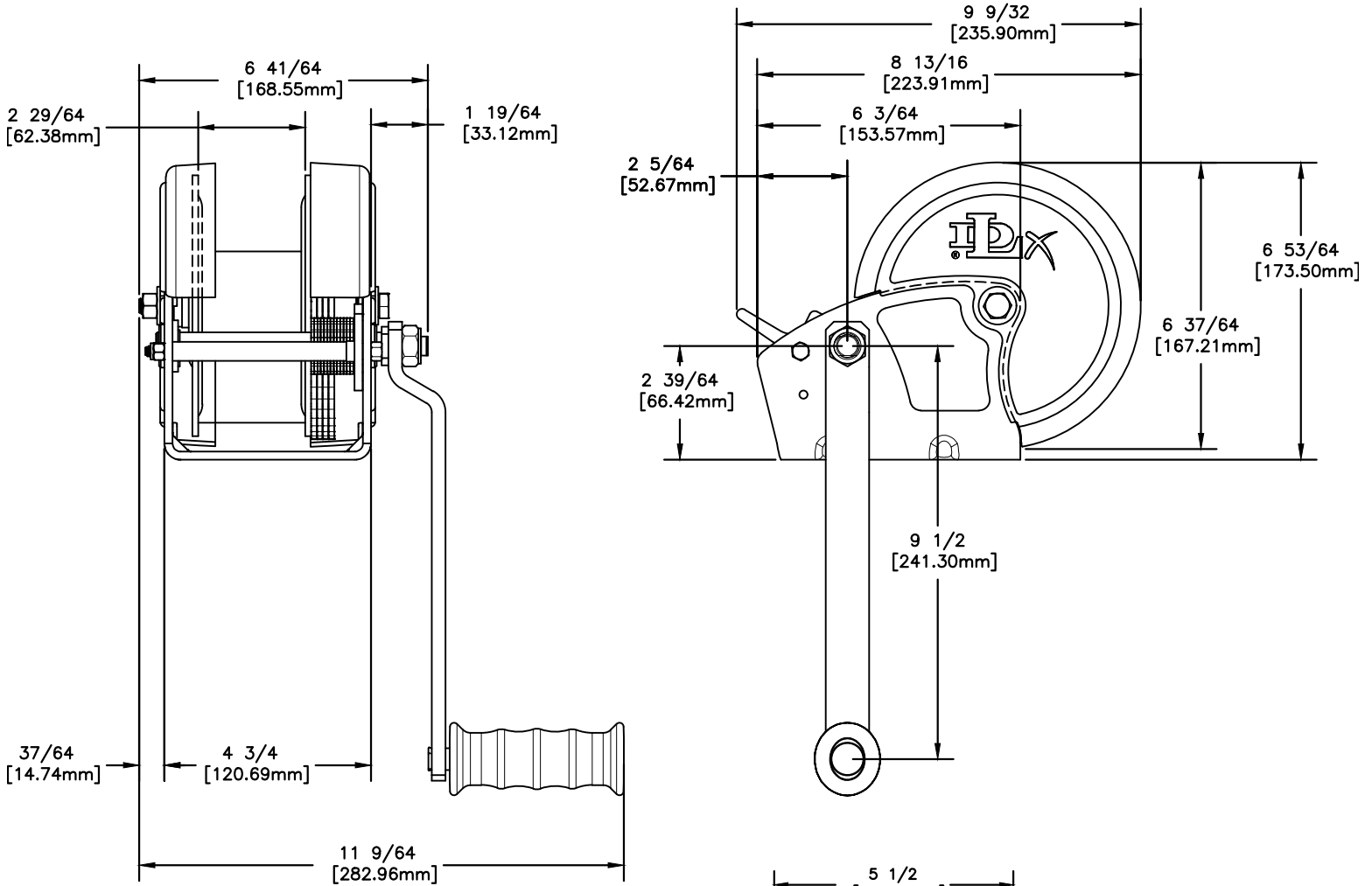

MODEL
DLx1900
1900lb/862kg CAPACITY
PULLING WINCH

FRONT & SIDE VIEW



BASE HOLE PATTERN

