

MODEL
DLB1500A/DLB1505A
1500lb/681kg CAPACITY
BRAKE WINCH

FRONT & SIDE VIEW

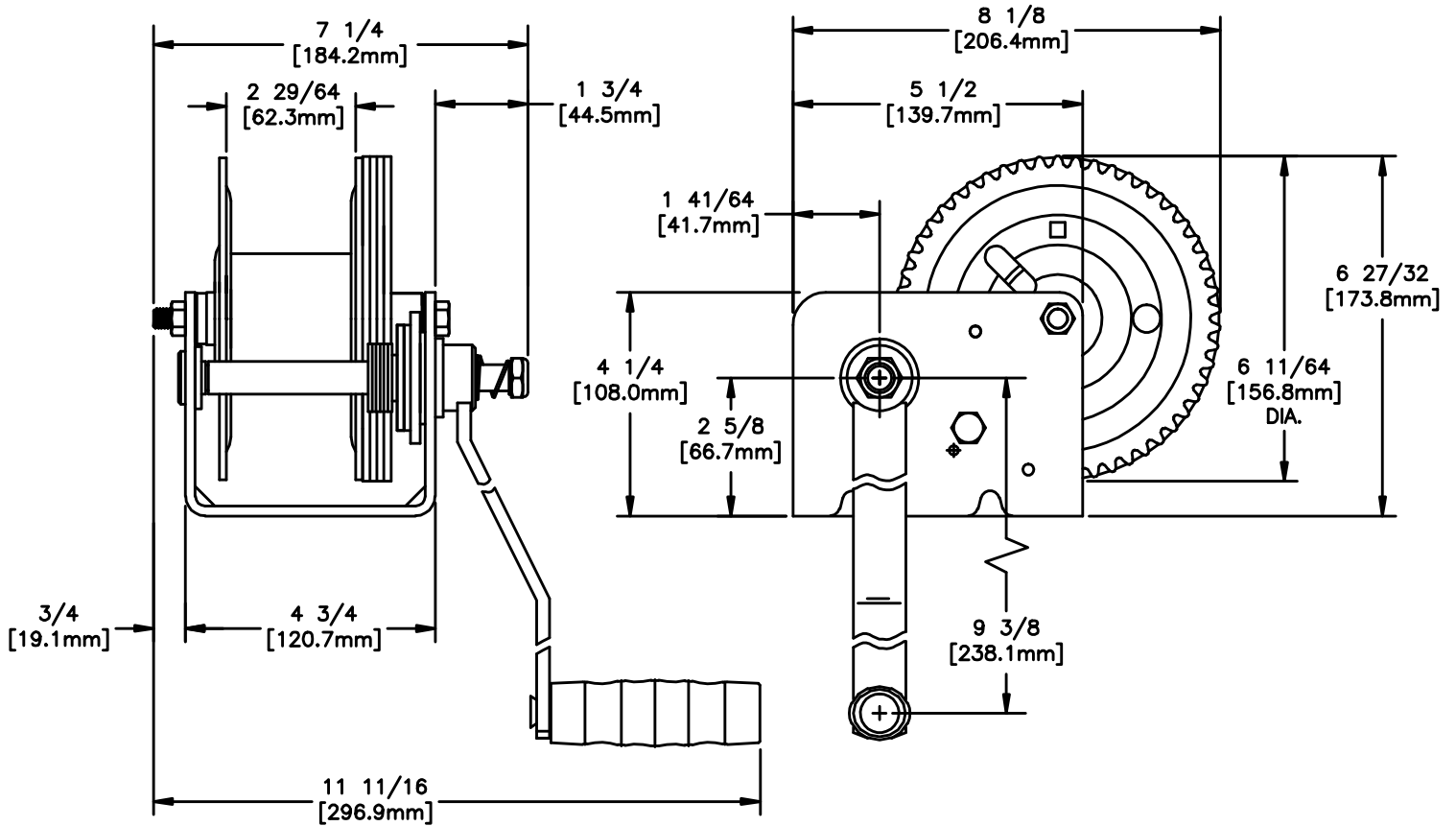

BASE HOLE PATTERN

