

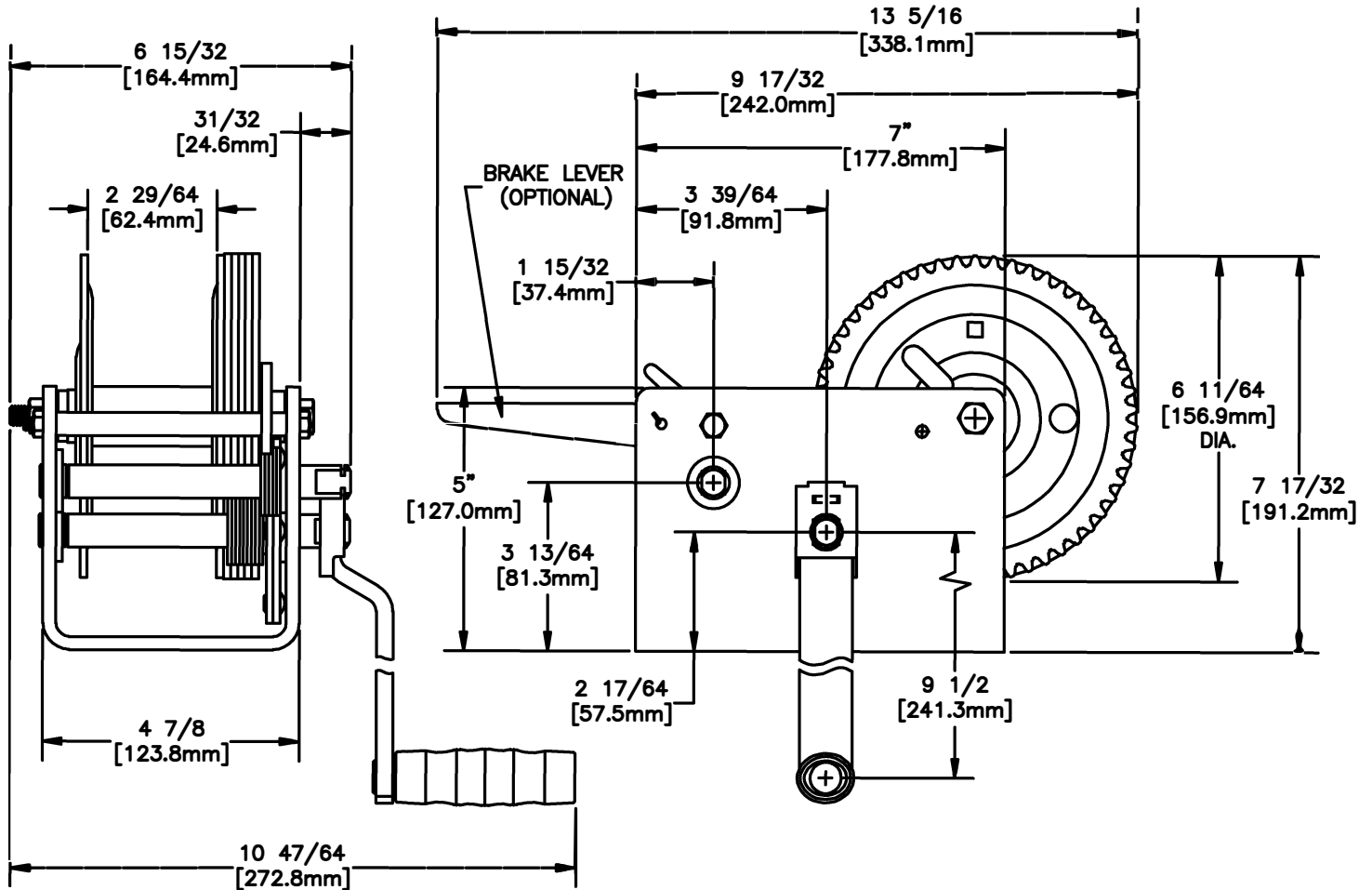

MODEL DL2500A
 2500lb/1135kg CAPACITY
 PULLING WINCH

FRONT & SIDE VIEW



BASE HOLE PATTERN

