

FRONT & SIDE VIEW

MODEL DL600A  
600lb/272kg CAPACITY  
PULLING WINCH

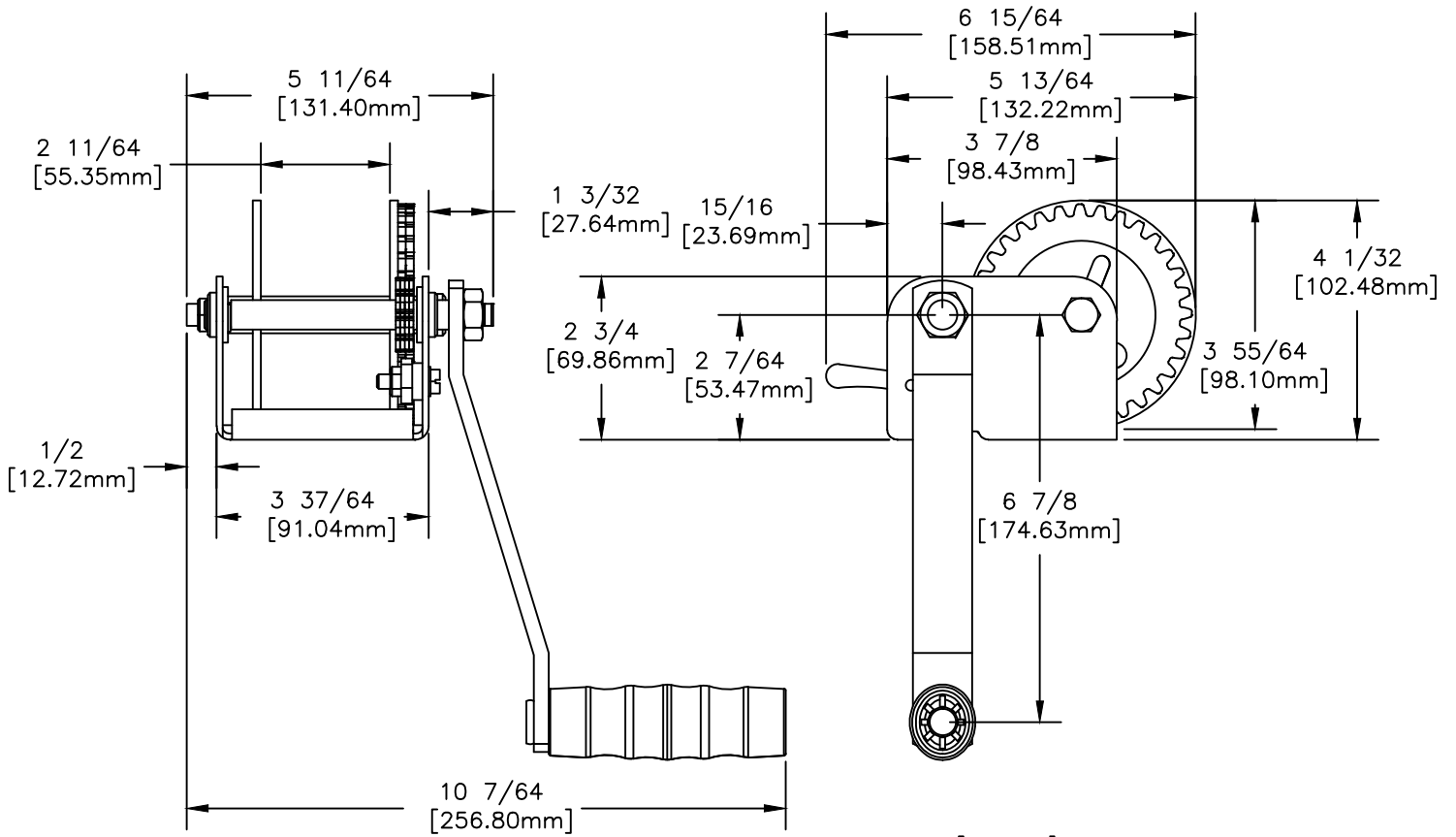

BASE HOLE PATTERN

