



Installation Instructions

PART NUMBERS: 36548, 90243, 06946

⚠ WARNING

To prevent **SERIOUS INJURY, DEATH or PROPERTY DAMAGE:**

- **ALWAYS read, understand and follow warnings and instructions for your hitch BEFORE installation. Keep for future reference.**
- **DO NOT cut, weld or modify this receiver.**
- **CHECK all fasteners are tight and your hitch is securely mounted to your vehicle periodically.**
- **ALWAYS read, understand and follow all warnings and instructions for your vehicle and for other accessories you will use with your hitch BEFORE use.**
- **LOAD the trailer heavier in front.**
- **DO NOT exceed lower of towing vehicle manufacturer’s rating or:**

Hitch Type	Max Gross Trailer Weight	Max Tongue Weight
Weight Carrying	3500lb. (1587kg)	300lb. (136kg)
Weight Distributing	N/A	N/A

- **ALWAYS wear your seatbelt.**
- **SLOW DOWN when towing, NEVER exceed any posted speed limit.**
- **If EXCESS SWAY occurs, take your foot off the gas pedal and hold the steering wheel as steady as possible. DO NOT apply your brakes and DO NOT speed up.**

LIMITED LIFETIME WARRANTY

1. **Limited Lifetime Warranty (“Warranty”).** Cequent Performance Products, Inc. (“We”, “Us” or “Our”) warrants to the original consumer purchaser only (“You” or “Your”) that the product will be free from material defects in both material and workmanship, ordinary wear and tear excepted. The Warranty is valid only if (a) the products are returned to Us for inspection and testing; (b) Our inspection discloses to Our satisfaction that any alleged nonconformance are material and have not been caused by misuse, neglect, wear and tear, improper installation, unsuitable storage, improper repair, alteration, or accident; and (c) the products were installed, maintained and used in accordance with Our instructions. **THE WARRANTY IS MADE IN LIEU OF ALL OTHER WARRANTIES, EXPRESS OR IMPLIED (OTHER THAN THE WARRANTY OF TITLE AS PROVIDED BY THE UNIFORM COMMERCIAL CODE IN EFFECT IN MICHIGAN), INCLUDING WITHOUT LIMITATION, ANY WARRANTIES OF MERCHANTABILITY OR FITNESS FOR A PARTICULAR PURPOSE, SAID WARRANTIES BEING EXPRESSLY DISCLAIMED.**
2. **Obligations of Purchaser.** To make a Warranty claim, contact Us at our principal address of 47912 Halyard Drive, Suite 100, Plymouth, MI 48170, 1-800-632-3290, identify the product by model number, and follow the claim instructions that will be provided. Any returned product that is replaced by Us becomes our property. You may be responsible for return shipping costs. Please retain your purchase receipt to verify date of purchase and that You are the original consumer purchaser. The product and the purchase receipt must be provided to Us in order to process Your Warranty claim.
3. **Exclusive Remedy.** Product replacement is Your sole and exclusive remedy under this Warranty. We shall not be liable for service or labor charges incurred in removing or replacing a product. **IN NO EVENT WILL WE BE RESPONSIBLE FOR ANY INDIRECT, SPECIAL, CONSEQUENTIAL OR PUNITIVE DAMAGES.**
4. **Assumption of Risk.** You acknowledge and agree that any use of the product for any purpose other than the specified use(s) stated in the product instructions is at Your own risk.
5. **Governing Law.** This Warranty gives You specific legal rights, and You also may have other rights which vary from state to state. This Warranty is governed by the laws of the State of Michigan, without regard to rules pertaining to conflicts of law. The state courts located in Oakland County, Michigan shall have exclusive jurisdiction for any disputes relating to this Warranty.



Installation Instructions

PART NUMBERS: 36548, 90243, 06946

Applications:

Years	Make	Models
2006-Current*	Dodge	Charger
2005-Current*	Chrysler	300
2008-Current*	Dodge	Challenger**
2005-2008	Dodge	Magnum

**DOES NOT FIT CHALLENGERS WITH QUAD EXHAUST TIPS

*Visit our website for the most up to date information regarding application years and trim levels.







Installation Time: 30 MIN.

The time listed above is the average time for professional installers. If you do not feel comfortable performing this installation on your own or are in need of assistance, please contact a professional installer.



Representative Vehicle Photo

Equipment Required:

 Safety Glasses	 Ratchet	 13 mm 15 mm 18 mm 3 / 4 " Sockets	 Torque Wrench	 Socket Extension
 Universal Joint Socket				

DO NOT EXCEED LOWER OF TOWING VEHICLE MANUFACTURER'S RATING OR:

Hitch Type	Max Gross Trailer Weight	Max Tongue Weight
Weight Carrying	3500 lb. (1587kg)	300lb. (136kg)
Weight Distributing	N/A	N/A

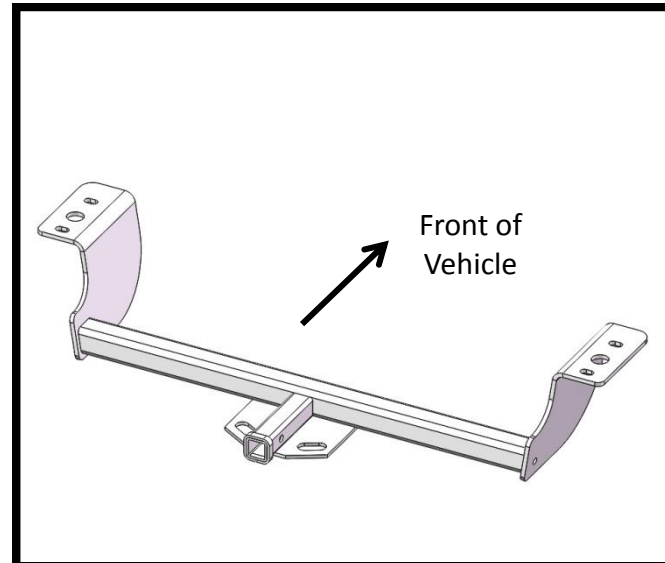







Hitch Illustration

Always wear SAFETY GLASSES when installing hitch

Installation Instructions

PART NUMBERS: 36548, 90243, 06946

①	Qty. (3)	Carriage bolt ½"-13 x 1.50 GR5	
②	Qty. (3)	Spacer 1" x 3"	
③	Qty. (3)	Hex nut ½"	
④	Qty. (4)	Conical Tooth Washer ½"	
⑤	Qty. (1)	Bolt M12 CL10.9	
⑥	Qty. (3)	Fish wire ½-13	

Fastener Kit: 36548F

Teeth side
against hitch

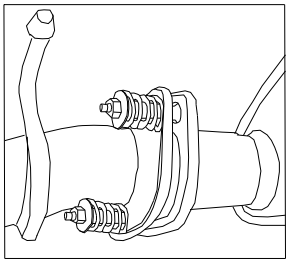
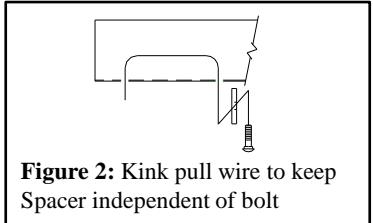
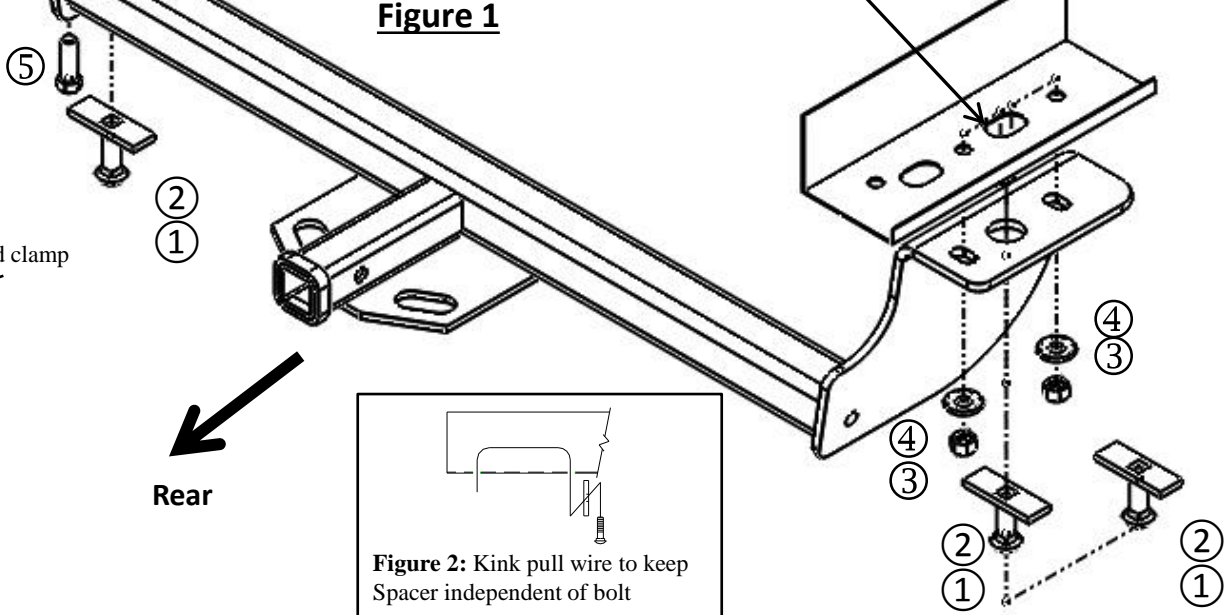
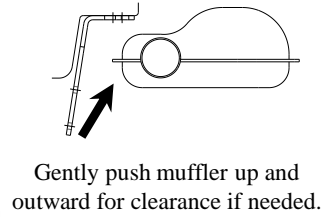
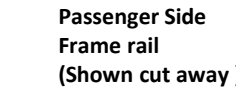
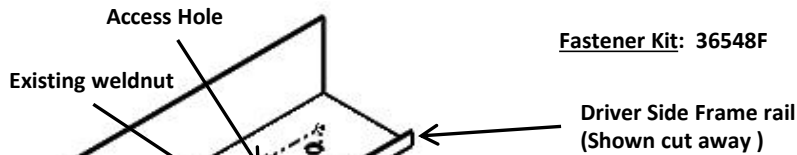

Figure 3.
2011 and newer V8 models - remove and save (2) assembly bolt and spring from the flange (nut and spring are attached).

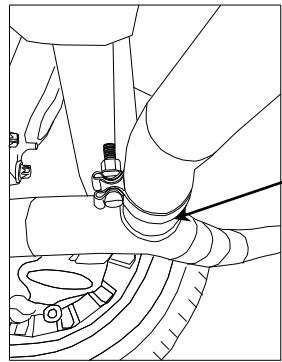

Figure 4.
2011 and newer V6 models remove and save band clamp, separate exhaust pipes and remove muffler.

Note: check hitch frequently, making sure all fasteners and ball are properly tightened. If hitch is removed, plug all holes in trunk pan or other body panels to prevent entry of water and exhaust fumes. A hitch or ball which has been damaged should be removed and replaced. Observe safety precautions when working beneath a vehicle and wear eye protection. Do not cut access or attachment holes with a torch.

All Pre-2011 installation:

1. Lower exhaust by removing (2 (13mm socket)) exhaust hanger/s per side (both sides on vehicles with dual exhaust). Spraying a lubricant or soapy water on the metal hanger rod and the rubber isolator helps removal.
2. Run the M12 bolt into the existing weldnut to clean dirt or debris from weldnut:
3. Fishwire ½” carriage bolts and spacers through the access holes on driver and passenger side frame rails, pull hardware through existing holes. (2) on passenger side and (1) on driver side.
4. Raise hitch into position by sliding the hitch over the mufflers and loosely install M12 bolt and conical tooth washer (teeth side against hitch) as shown into existing weldnut.
5. Install the ½” conical tooth washer (teeth side against hitch) and ½” nuts.
6. **Torque all ½” fasteners to 75ftlb. (102N*M) and the M12 bolt to 68ftlb (92N*M).**



Proper torque is needed to keep the hitch secure to the vehicle when towing!

7. Re-install exhaust hangers.

2011 and newer installation. Vehicle will need to be raised a minimum of 20” (bottom of fascia to ground) for installation.

1. On Chrysler 300/300C Remove plastic appearance panels which cover trunk pan. Return appearance panels and fasteners to vehicle owner
2. Lower exhaust by removing (2 (13mm socket)) exhaust hangers per side. This will allow access to frame rail by pushing the muffler up and outward for clearance. The removal of the rubber isolator/s, from hanger/s off exhaust pipe/s forward of the trunk pan, will allow additional clearance. Spraying a lubricant or soapy water on the metal hanger/s rod and the rubber isolator helps removal.
3. Remove the (1) muffler from the vehicle.

On V8 models - remove and save (2) assembly bolt and spring from the flange (nut and spring are attached). Carefully remove muffler from driver’s side. See figure 3

On V6 models - remove and save band clamp, separate exhaust pipes and remove muffler. Band clamp located just before “Y” connection on exhaust. Carefully remove muffler from driver’s side. See figure 4

4. Run the M12 bolt into the existing weldnut to clean dirt or debris from weldnut:
5. Fishwire ½” carriage bolts and spacers through the access holes on driver and passenger side frame rails, pull hardware through existing holes. (2) on passenger side and (1) on driver side.
6. Raise passenger side bracket into place over the passenger muffler. Support the passenger side bracket while loosely installing the M12 bolt & conical tooth washer (teeth side against hitch) through the bracket and into the frame rail on the driver’s side to hold hitch in place. Then gently pushing the passenger muffler up and outward for clearance, install the ½” conical tooth washer (teeth side against hitch) and ½” nuts.
7. **Torque all ½” fasteners to 75ftlb. (102N*M) and the M12 bolt to 68ftlb (92N*M).**



Proper torque is needed to keep the hitch secure to the vehicle when towing!

8. Re-install exhaust hangers.

Note: check hitch frequently, making sure all fasteners and ball are properly tightened. If hitch is removed, plug all holes in trunk pan or other body panels to prevent entry of water and exhaust fumes. A hitch or ball which has been damaged should be removed and replaced. Observe safety precautions when working beneath a vehicle and wear eye protection. Do not cut access or attachment holes with a torch.