

MAN

Spare parts for trucks

Qualität – made by
dph Germany

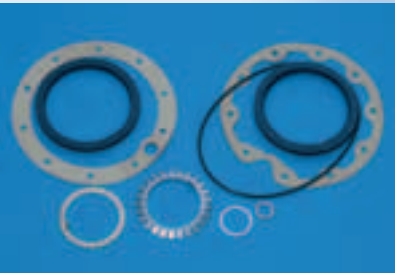

dph[®]

Dichtungspartner Hamburg

Important notes

- 1.** This catalogue replaces all previous issues.
- 2.** The catalogue is protected by copyright.
The duplication of it or any part of it is prohibited.
- 3.** The supply of dph components strictly adhere to our sales and delivery agreement and are subject to our conditions of payment.
- 4.** We reserve the right to modify our components as necessary.
- 5.** The original equipment part numbers, as well as SLP, Elring-No., etc. indicated in the catalogue only serve as a cross-reference comparison with dph numbers. They must not appear on any advice notes or invoices.
- 6.** All original part numbers of engine or vehicle manufacturers in this catalogue are mentioned for comparison reasons only and should not be used in contacts with vehicle owners.
- 7.** Every effort has been made to ensure that the information in this catalogue is correct at the time of printing, but dph cannot accept any responsibility for errors which may occur.

Qualität – made by dph Germany



High quality guarantees growing success



We have always supplied our customers with high quality seals for the following sectors: Automobile, hydraulic seals, mountings and other fields all at reasonable prices and quick delivery. We can count many well-known companies throughout the world as satisfied customers.

Four strategies guarantee our success:

- First rate products with top class quality assured
- Short delivery times due to our own stock levels
- Flexibility in the procurement of all parts
- Attractive pricing policy









Fully automated electronic quality checks and manufacturing to DIN standards guarantee continuous high quality products. To your advantage and always at very fair prices.

Perfect manufacturing and continuous quality assurance

Together we are strong – this is the maxim in our group. High quality is not achieved just as a result of monitoring but of production technique. Therefore, Dichtungspartner Hamburg receives the bulk of its products from OEM suppliers and from suppliers whose quality management is certified in accordance with DIN/ISO 9000/9001.

Despite this, we still think it is necessary to check the finished products thoroughly once more within our group according to DIN/ISO 9001. Our high-grade measuring instruments are checking the radial force of oil seals, the tensile strength of elastomers, the compression set and the surface quality by means of computer-based cameras and many more. The results of the checks are registered and filed. It is good to have confidence but qualification is better!

Contents

	OEM numbers, reference list	6 – 12
	Engine gaskets and gasket sets	13 – 31
	Cylinder head gaskets & sets, cylinder liner sealing rings & kits, cylinder liner sealing ring, complete gasket sets, valve cover gaskets, oil pan gaskets & kits, manifold gaskets, full sets, oil seals for engine	
	Engine parts, fuel, exhaust and cooling system parts	32 – 62
	Oil seals, washers, o-rings, gaskets, oil seals crankshaft	
	Clutch, gearbox	63 – 65
	Servo cylinders, o-rings, transmission oil seals	
	Brake parts	66
	Diaphragms	
	Front and rear axle parts, steering	67 – 70
	Servo cylinders, o-rings, transmission oil seals	
	Overview of most popular oil seal types	71
	Standard terms and conditions	72 – 73

OEM numbers, reference list

OEM-no.	dph-no.	description	page
-	80056	Repair kit for ABS rear axle	68
-	81438	Repair kit for ABS rear axle	69
-	81548	Repair kit for ABS rear axle	69
-	81895	Repair kit for ABS rear axle	68
-	81896	Repair kit for ABS front axle	69
-	94501	Repair kit for ABS rear axle	68
0024 411 524	35085	Oil seals – various	32
0024 411 800	35086	Oil seals – various	32
0024 411 971	35087	Oil seals – various	32
0024 411 973	35088	Oil seals – various	32
05 56190 0706	34882	Sealing washer, copper/various	40
06 56180 0704	81101	Sealing washer, copper/various	40
06 56180 0708	80897	Sealing washer, copper/various	40
06 56180 0709	34953	Sealing washer, copper/various	40
06 56180 0712	109079	Sealing washer, copper/various	41
06 56180 0713	94224	Sealing washer, copper/various	40
06 56180 0716	34789	Sealing washer, copper/various	41
06 56190 0704	51457	Sealing washer, copper/various	40
06 56190 0705	34812	Sealing washer, copper/various	40
06 56190 0706	4460	Sealing washer, copper/various	40
06 56190 0708	36176	Sealing washer, copper/various	40
06 56190 0709	21232	Sealing washer, copper/various	40
06 56190 0718	36177	Sealing washer, copper/various	40
06 56190 0712	93160	Sealing washer, copper/various	40
06 56190 0713	34339	Washer – engine	39
06 56190 0715	82992	Sealing washer, copper/various	40
06 56190 0716	98714	Sealing washer, copper/various	40
06 56190 0719	94713	Sealing washer, copper/various	41
06 56190 0722	81518	Sealing washer, copper/various	41
06 56190 0726	36837	Sealing washer, copper/various	41
06 56190 0727	35243	Sealing washer, copper/various	41
06 56190 0732	51218	Sealing washer, copper/various	41
06 56190 0734	84506	Sealing washer, copper/various	41
06 56190 0739	94785	Sealing washer, copper/various	41
06 56190 0822	35006	Sealing washer, aluminium/various	41
06 56192 0732	98099	Sealing washer, copper/various	41
06 56200 0811	37553	Sealing washer, aluminium/various	41
06 56261 1207	35089	Oil seals – various	32
06 56261 1615	35090	Transmission oil seal	63
06 56261 1911	4716	Transmission oil seal	63
06 56269 0001	35091	Oil seals – various	32
06 56271 0404	82925	Oil seals – various	32
06 56271 0406	82926	Oil seals – various	32
06 56271 0807	35092	Transmission oil seal	63
06 56271 1613	82860	Oil seals – various	32
06 56271 1616	82927	Oil seals – various	32
06 56271 2015	35093	Oil seals – various	32
06 56271 3814	84398	Oil seals – various	32
06 56272 0047	35094	Transmission oil seal	63
06 56272 1212	35096	Oil seal – various	33
06 56272 1312	35097	Oil seal for rear axle	69
06 56272 1313	35098	Oil seal – various	33
06 56272 1613	35099	Oil seal – various	33
06 56272 1614	35100	Oil seal – various	33
06 56272 1714	35101	Oil seal – various	33

OEM-no.	dph-no.	description	page
06 56272 1814	35102	Oil seal – various	33
06 56272 1816	35103	Oil seal – various	33
06 56272 2016	35106	Oil seal for rear axle	69
06 56272 8016	84399	Oil seal for rear axle	69
06 56274 1714	35107	Oil seal for rear axle	69
06 56275 0047	35116	Transmission oil seal	63
06 56279 0014	35108	Oil seal – various	33
06 56279 0019	35109	Oil seal – engine housing	31
06 56279 0025	82931	Oil seal for front axle	67
06 56279 0028	35110	Oil seal for front axle	67
06 56279 0029	80537	Oil seal for front axle	67
06 56279 0031	69795	Oil seal for front axle	67
06 56279 0042	35115	Transmission oil seal	63
06 56279 0050	35117	Transmission oil seal	63
06 56279 0054	35118	Oil seal – various	33
06 56279 0055	35119	Oil seal – various	33
06 56279 0057	35121	Oil seal for rear axle	69
06 56279 0059	35123	Oil seal – various	33
06 56279 0066	35126	Oil seal – various	33
06 56279 0073	46636	Oil seal – engine housing	31
06 56279 0087	35127	Transmission oil seal	63
06 56279 0095	96525	Oil seal for front axle	67
06 56279 0114	80281	Oil seal for rear axle	70
06 56279 0133	35264	Oil seal for rear axle	70
06 56279 0147	96080	Transmission oil seal	63
06 56279 0148	96079	Transmission oil seal	63
06 56279 0181	69190	Oil seal for front axle	67
06 56279 0183	48119	Oil seal for rear axle	69
06 56279 0184	80282	Oil seal for rear axle	69
06 56279 0215	81190	Oil seal for rear axle	69
06 56279 0235	104429	Oil seal – various	33
06 56279 0262	94804	Oil seal – various	33
06 56279 0273	61341	Oil seal – various	33
06 56279 0284	95831	Oil seal – various	33
06 56279 0289	95832	Oil seal – various	33
06 56279 0297	81191	Oil seal – various	33
06 56279 0310	84546	Oil seal – various	33
06 56279 0312	69160	Oil seal – engine housing	31
06 56279 0323	93350	Oil seal – various	33
06 56279 0327	61407	Oil seal – various	33
06 56279 0335	69845	Oil seal – various	33
06 56279 0350	81590	Oil seal – various	34
06 56279 0353	95833	O-ring/engine – various	44
06 56281 0605	33649	Oil seal for front axle	67
06 56282 0906	35128	Oil seal – various	34
06 56282 1007	109419	Oil seal for front axle	68
06 56282 1813	35129	Oil seal for rear axle	70
06 56282 2015	35130	Oil seal – various	34
06 56289 0013	35131	Oil seal for front axle	68
06 56289 0022	34633	Oil seal for rear axle	70
06 56289 0027	34647	Oil seal for rear axle	70
06 56289 0031	35145	Oil seal – various	34
06 56289 0033	35147	Transmission oil seal	63
06 56289 0035	35149	Oil seal for rear axle	70
06 56289 0037	35150	Oil seal for front axle	68

OEM-no.	dph-no.	description	page
06 56289 0039	35151	Oil seal for rear axle	70
06 56289 0040	35152	Oil seal for front & rear axle	67
06 56289 0041	32782	Oil seal for rear axle	70
06 56289 0045	35153	Oil seal for front & rear axle	67
06 56289 0046	35154	Oil seal – various	34
06 56289 0047	33421	Oil seal for rear axle	70
06 56289 0048	68551	Oil seal for rear axle	70
06 56289 0050	51458	Oil seal for front axle	68
06 56289 0052	35155	Oil seal for front axle	68
06 56289 0063	35156	Oil seal – various	34
06 56289 0064	34818	Oil seal for rear axle	70
06 56289 0065	34819	Oil seal – various	34
06 56289 0066	84522	Oil seal for rear axle	70
06 56289 0132	35690	Transmission oil seal	64
06 56289 0139	96083	Transmission oil seal	64
06 56289 0145	34645	Oil seal for rear axle	70
06 56289 0167	68541	Transmission oil seal	63
06 56289 0181	51884	Oil seal – various	34
06 56289 0186	84394	Oil seal for rear axle	70
06 56289 0191	80482	Transmission oil seal	64
06 56289 0191	110696	Transmission oil seal	64
06 56289 0207	110697	Oil seal – various	34
06 56289 0215	82278	Oil seal for front axle	68
06 56289 0221	80283	Oil seal for front axle	68
06 56289 0236	93449	Transmission oil seal	64
06 56289 0241	93450	Oil seal – various	34
06 56289 0248	96261	Oil seal – various	34
06 56289 0267	35259	Oil seal for front axle	68
06 56289 0309	82322	Oil seal for rear axle	70
06 56289 0315	81610	Oil seal – various	34
06 56289 0321	80856	Oil seal – various	34
06 56289 0322	82967	Oil seal – various	34
06 56289 0324	37845	Oil seal – various	34
06 56289 0332	82113	Oil seal for rear axle	70
06 56289 0334	32639	Oil seal for rear axle	70
06 56289 0335	6652	Oil seal for rear axle	70
06 56289 0349	80358	Oil seal – various	34
06 56289 0353	61486	Oil seal – various	34
06 56289 0366	83892	Oil seal – various	34
06 56289 0369	109684	Oil seal – various	34
06 56289 0371	82320	Oil seal for rear axle	70
06 56289 0385	81568	Oil seal – various	34
06 56289 0386	93474	Oil seal – various	34
06 56289 0387	111280	Oil seal – various	34
06 56292 0101	35157	Oil seal for front & rear axle	67
06 56311 0139	69856	O-ring/engine – various	44
06 56331 0215	33778	O-ring/engine – various	44
06 56331 0216	33305	O-ring/engine – various	44
06 56331 0219	33306	O-ring/engine – various	44
06 56331 0220	50873	O-ring/engine – various	44
06 56331 0225	98101	O-ring/engine – various	44
06 56331 0226	6665	O-ring/engine – various	44
06 56331 0238	6666	O-ring/engine – various	44
06 56331 0252	33307	O-ring/engine – various	44
06 56331 0257	35139	O-ring/engine – various	44

OEM-no.	dph-no.	description	page
06 56331 0263	6667	O-ring/engine – various	44
06 56331 0264	82933	O-ring/engine – various	45
06 56331 0270	33308	O-ring/engine – various	45
06 56331 0334	4110	O-ring/engine – various	45
06 56331 1116	33309	O-ring/engine – various	45
06 56331 1165	33310	O-ring/seal ring – engine/fuel/oil filter	42
06 56331 1209	6668	O-ring/engine – various	45
06 56331 1219	50503	O-ring/engine – various	45
06 56331 1227	80469	O-ring/engine – various	45
06 56331 1234	82107	O-ring/engine – various	45
06 56331 1248	6635	O-ring/engine – various	45
06 56331 1256	82351	O-ring/engine – various	45
06 56331 1259	110984	O-ring/seal ring – engine/fuel/oil filter	42
06 56331 1280	33311	O-ring/engine – various	45
06 56331 2164	93491	O-ring/seal ring – engine/fuel/oil filter	42
06 56331 2219	98098	O-ring/engine – various	45
06 56331 2222	35941	O-ring/engine – various	45
06 56331 2232	37565	O-ring/engine – various	45
06 56331 2241	82108	O-ring/engine – various	45
06 56331 2244	80685	O-ring/engine – various	45
06 56331 2245	33714	O-ring/engine – various	45
06 56331 3205	94712	O-ring/engine – various	45
06 56331 3222	35940	O-ring/engine – various	45
06 56331 3257	6475	O-ring/engine – various	45
06 56331 3264	33150	O-ring/seal ring – engine/fuel/oil filter	43
06 56331 3269	48734	O-ring/seal ring – engine/fuel/oil filter	43
06 56331 3274	61437	O-ring/engine – various	45
06 56331 3332	4032	O-ring/engine – various	45
06 56331 3406	37284	O-ring/engine – various	46
06 56331 3423	97139	O-ring/engine – various	46
06 56331 4158	33312	O-ring/engine – various	46
06 56331 4200	36399	O-ring/engine – various	46
06 56331 4207	81694	O-ring/engine – various	46
06 56331 4210	34264	O-ring/engine – various	46
06 56331 4212	34265	O-ring/engine – various	46
06 56331 4217	82279	O-ring/engine – various	46
06 56331 4222	33373	O-ring/engine – various	46
06 56331 4242	6474	O-ring/seal ring – engine/fuel/oil filter	43
06 56331 4244	110919	O-ring/engine – various	46
06 56331 4266	36261	O-ring/engine – various	46
06 56331 4269	22976	O-ring/engine – various	46
06 56331 4270	22975	O-ring/engine – various	46
06 56331 4271	24960	O-ring/engine – various	46
06 56332 0265	94442	O-ring/engine – various	46
06 56332 2167	80498	O-ring/engine – various	46
06 56332 4206	36751	O-ring/clutch/gearbox	64
06 56332 4254	6637	O-ring/engine – various	46
06 56332 4280	81047	O-ring/engine – various	46
06 56333 0240	33154	O-ring/engine – various	46
06 56333 0334	33313	O-ring/engine – various	46
06 56333 1169	4575	O-ring/engine – various	46
06 56333 1211	93420	O-ring/engine – various	46
06 56333 1242	81607	O-ring/engine – various	46
06 56333 2316	110891	O-ring/engine – various	46
06 56333 2363	33155	O-ring/engine – various	47

OEM-no.	dph-no.	description	page
06 56333 3180	33315	O-ring/engine – various	47
06 56333 3206	81048	O-ring/engine – various	47
06 56333 3248	110923	O-ring/engine – various	47
06 56333 3256	32660	O-ring/engine – various	47
06 56333 3276	32880	O-ring/engine – various	47
06 56333 3280	80589	O-ring/engine – various	47
06 56333 3306	97102	O-ring/engine – various	47
06 56333 3363	84385	O-ring/engine – various	47
06 56333 4245	34788	O-ring/engine – various	47
06 56333 4274	111015	O-ring/engine – various	47
06 56333 4277	84386	O-ring/engine – various	47
06 56333 4314	51469	O-ring/engine – various	47
06 56341 0209	93832	O-ring/engine – various	47
06 56341 0223	36762	O-ring/engine – various	47
06 56341 0234	33846	O-ring/engine – various	47
06 56341 0251	111077	O-ring/engine – various	47
06 56341 1118	81576	O-ring/engine – various	47
06 56341 1122	6669	O-ring/seal ring – engine/fuel/oil filter	43
06 56341 1201	68275	O-ring/engine – various	47
06 56341 1209	69857	O-ring/seal ring – engine/fuel/oil filter	43
06 56341 1213	93502	O-ring/seal ring – engine/fuel/oil filter	43
06 56341 1236	6670	O-ring/engine – various	47
06 56341 1239	33978	O-ring/engine – various	47
06 56341 1257	32082	O-ring/engine – various	47
06 56341 1260	61436	O-ring/engine – various	47
06 56341 2122	6671	O-ring/seal ring – engine/fuel/oil filter	43
06 56341 2129	33709	O-ring/engine – various	48
06 56341 3205	82928	O-ring/engine – various	48
06 56341 3219	33316	O-ring/engine – various	48
06 56341 3237	36262	O-ring/engine – various	48
06 56341 3245	82929	O-ring/engine – various	48
06 56341 3258	51559	O-ring/engine – various	48
06 56341 3259	51560	O-ring/engine – various	48
06 56341 3271	6672	O-ring/engine – various	48
06 56341 3350	6673	O-ring/engine – various	48
06 56341 4135	95606	O-ring/engine – various	48
06 56341 4210	32537	O-ring/engine – various	48
06 56341 4254	6525	O-ring/rear axle	70
06 56341 4259	70802	O-ring/engine – various	48
06 56342 0206	6675	O-ring/engine – various	48
06 56342 0331	35942	O-ring/engine – various	48
06 56342 2216	3933	O-ring/clutch/gearbox	64
06 56342 4241	93421	O-ring/engine – various	48
06 56343 1238	34844	O-ring/engine – various	48
06 56343 3236	93557	O-ring/engine – various	48
06 56343 3242	94687	O-ring/engine – various	48
06 56349 0037	33597	O-ring/engine – various	48
06 56349 0066	34177	Cylinder liner sealing ring	20
06 56349 0077	37003	O-ring/engine – various	48
06 56639 0011	4345	Gasket	59
06 56820 0323	84138	O-ring/engine – various	48
06 56822 0223	51533	O-ring/engine – various	48
06 56824 0125	110788	O-ring/engine – various	49
06 56824 0177	33968	O-ring/engine – various	49
06 56824 0302	110789	O-ring/engine – various	49

OEM-no.	dph-no.	description	page
06 56824 0327	48909	O-ring/engine – various	49
06 56824 0410	80790	O-ring/engine – various	49
06 56824 0419	32495	O-ring/engine – various	49
06 56824 0428	61535	O-ring/engine – various	49
06 56824 0430	34579	O-ring/engine – various	49
06 56824 0502	34167	O-ring/engine – various	49
06 56824 0601	34189	O-ring/engine – various	49
06 56824 0608	35730	O-ring/engine – various	49
06 56824 0623	61536	O-ring/engine – various	49
06 56824 0624	4120	O-ring/engine – various	49
06 56832 0337	68617	O-ring/engine – various	49
06 56832 0508	51743	O-ring/engine – various	49
06 56832 0518	33424	O-ring/engine – various	49
06 56832 0523	68570	O-ring/engine – various	49
06 56834 0121	34190	O-ring/engine – various	49
06 56834 0126	34168	O-ring/engine – various	49
06 56834 0133	15273	O-ring/engine – various	49
06 56834 0225	34191	O-ring/engine – various	49
06 56930 0632	68516	O-ring/seal ring – engine/fuel/oil filter	43
06 56930 2107	81158	O-ring/seal ring – engine/fuel/oil filter	43
06 56930 2618	68517	O-ring/engine – various	50
06 56930 3036	82486	O-ring/seal ring – engine/fuel/oil filter	43
06 56930 3307	96533	O-ring/engine – various	50
06 56930 3674	93493	O-ring/engine – various	49
06 56930 3692	80290	O-ring/engine – various	50
06 56930 3809	36263	O-ring/seal ring – engine/fuel/oil filter	43
06 56930 3880	80291	O-ring/engine – various	50
06 56930 4096	81608	O-ring/engine – various	50
06 56930 4388	93475	O-ring/seal ring – engine/fuel/oil filter	43
06 56936 0347	59314	O-ring/engine – various	50
06 56936 0459	109764	O-ring/engine – various	50
06 56936 1051	61638	O-ring/engine – various	50
06 56936 2479	94383	O-ring/engine – various	50
06 56936 2632	109766	O-ring/engine – various	50
06 56936 2846	82037	O-ring/engine – various	50
06 56936 6409	109765	O-ring/engine – various	50
06 56937 3914	6678	Cylinder liner sealing ring	19
06 56938 0522	51532	O-ring/engine – various	50
06 56939 0017	82109	O-ring/engine – various	50
06 56939 0018	82110	O-ring/engine – various	50
06 56939 0029	94649	O-ring/engine – various	50
06 56939 0030	82111	O-ring/engine – various	50
06 56939 0031	82112	O-ring – engine/various	35
06 56939 0033	94225	O-ring – engine/various	35
06 56939 0053	109767	O-ring – engine/various	35
06 56939 0054	109769	O-ring – engine/various	35
11202 0037	93833	O-ring/seal ring – engine/fuel/oil filter	43
50 96501 0354	69150	O-ring – engine/various	35
50 96501 0433	111091	O-ring – engine/various	35
50 96501 0434	111090	O-ring – engine/various	35
51 00900 6398	96840	Full set	22
51 00900 6404	84627	Full set	22
51 00900 6424	96540	Cylinder head gasket set	15
51 00900 6456	98566	Full set	22
51 00900 6458	96839	Full set	23

OEM-no.	dph-no.	description	page
51 00900 6471	96838	Full set	22
51 00900 6550	96542	Cylinder head gasket set	16
51 00900 6558	81542	Cylinder head gasket set	16
51 00900 6570	81193	Cylinder head gasket set	15
51 00900 6628	109693	Cylinder head gasket set	15
51 00900 6629	109694	Cylinder head gasket set	17
51 00900 6630	109287	Cylinder head gasket set	15
51 01222 0001	80367	Gasket	58
51 01222 0002	80369	Gasket	58
51 01510 0133	36178	Oil seal crankshaft	60
51 01510 0138	80244	Oil seal crankshaft	60
51 01510 0141	37179	Oil seal crankshaft	60
51 01510 0150	61360	Oil seal crankshaft	60
51 01510 0151	109688	Oil seal crankshaft – back	61
51 01510 0152	111394	Oil seal crankshaft – front	60
51 01510 0196	108819	Oil seal crankshaft	60
51 01510 0197	82544	Oil seal crankshaft – front	60
51 01510 0206	70512	Oil seal crankshaft – back	61
51 01510 0206	70512	Oil seals crankshaft – back	62
51 01510 0228	109687	Oil seal crankshaft – front	60
51 01510 6004	81122	Oil seal crankshaft	60
51 01903 0166	36179	Valve cover gasket	25
51 03901 0262	96511	Cylinder head gasket	14
51 03901 0275	96510	Cylinder head gasket	13
51 03901 0285	96539	Cylinder head gasket	13
51 03901 0298	96510	Cylinder head gasket	13
51 03901 0338	93642	Cylinder head gasket	14
51 03901 0342	94930	Cylinder head gasket	14
51 03901 0356	94931	Cylinder head gasket	13
51 03901 0356	94931	Cylinder head gasket	14
51 03901 0357	96541	Cylinder head gasket	14
51 03901 0379	109695	Cylinder head gasket	14
51 03905 0103	70815	Valve cover gasket	25
51 03905 0108	96328	Valve cover gasket	25
51 03905 0134	68993	Valve cover gasket	23
51 03905 0135	61251	Valve cover gasket	25
51 03905 0148	96263	Valve cover gasket	23
51 03905 0155	109692	Valve cover gasket	23
51 03905 0157	109810	Valve cover gasket	25
51 03905 0161	109811	Valve cover gasket	25
51 04902 0008	82878	Valve stem seal	18
51 04902 0023	4705	Valve stem seal	18
51 04902 0028	51314	Valve stem seal	17
51 05901 0107	93595	Gasket	58
51 05901 0116	93490	Gasket	58
51 05904 0083	61052	Oil pan gasket	27
51 05904 0131	97750	Oil pan gasket	27
51 05904 0132	59273	Oil pan gasket	27
51 05904 0133	96824	Oil pan gasket	26
51 05904 0134	84455	Oil pan gasket	26
51 05904 0139	96432	Oil pan gasket	25
51 05904 0157	97543	Oil pan gasket	26
51 05904 0171	109876	Oil pan gasket	25
51 05904 0198	109544	Oil pan gasket	27
51 06901 0027	98100	O-ring – engine/variou	35

OEM-no.	dph-no.	description	page
51 06901 0108	81915	Gasket	58
51 08901 0023	61060	Manifold gasket – EXHAUST	28
51 08901 0027	97113	Manifold gasket – EXHAUST	28
51 08902 0115	61054	Manifold gasket – INTAKE	30
51 08902 0121	97114	Manifold gasket – INTAKE	30
51 08902 0135	96870	Manifold gasket – INTAKE	30
51 08902 0161	83878	Manifold gasket – INTAKE	29
51 08902 0179	109876	Manifold gasket – INTAKE	29
51 54901 0012	82294	Gasket	58
51 54901 0027	96123	Gasket	58
51 54901 0028	61543	Gasket	58
51 54901 0029	61544	Gasket	59
51 54901 0051	111270	Gasket/engine	59
51 96001 0041	94306	Gasket/engine	59
51 96101 0048	6397	Gasket	59
51 96501 0007	68991	O-ring – engine/variou	35
51 96501 0023	84406	O-ring – engine/variou	35
51 96501 0035	33151	O-ring – engine/variou	35
51 96501 0092	6680	O-ring – engine/variou	35
51 96501 0146	36615	O-ring – engine/variou	35
51 96501 0151	6679	O-ring – engine/variou	35
51 96501 0166	6681	O-ring – engine/variou	36
51 96501 0184	33317	O-ring – engine/variou	36
51 96501 0203	32760	O-ring – engine/variou	36
51 96501 0234	6682	O-ring – engine/variou	36
51 96501 0260	32571	O-ring – engine/variou	36
51 96501 0261	69858	O-ring/seal ring – engine/fuel/oil filter	43
51 96501 0262	37302	O-ring – engine/variou	36
51 96501 0263	35291	Cylinder liner sealing ring	21
51 96501 0265	33146	O-ring/seal ring – engine/fuel/oil filter	42
51 96501 0286	93465	O-ring/seal ring – engine/fuel/oil filter	42
51 96501 0288	37296	O-ring/seal ring – engine/fuel/oil filter	42
51 96501 0295	35988	Gasket/engine	59
51 96501 0305	82759	O-ring – engine/variou	36
51 96501 0322	4600	O-ring/seal ring – engine/fuel/oil filter	42
51 96501 0324	33366	O-ring/seal ring – engine/fuel/oil filter	42
51 96501 0326	110895	O-ring – engine/variou	36
51 96501 0327	6683	O-ring/seal ring – engine/fuel/oil filter	43
51 96501 0337	6684	O-ring/seal ring – engine/fuel/oil filter	42
51 96501 0338	6685	Cylinder liner sealing ring	21
51 96501 0342	6473	O-ring/seal ring – engine/fuel/oil filter	42
51 96501 0346	4714	Cylinder liner sealing ring	21
51 96501 0347	33152	O-ring – engine/variou	36
51 96501 0348	3937	Gasket/engine	59
51 96501 0355	6686	O-ring – engine/variou	36
51 96501 0357	4571	Cylinder liner sealing ring	19
51 96501 0361	33149	O-ring – engine/variou	36
51 96501 0372	34822	O-ring – engine/variou	36
51 96501 0393	6524	O-ring/seal ring – engine/fuel/oil filter	43
51 96501 0409	6687	Cylinder liner sealing ring	21
51 96501 0412	6688	Cylinder liner sealing ring	20
51 96501 0412	6688	O-ring/seal ring – engine/fuel/oil filter	42
51 96501 0413	6689	O-ring/seal ring – engine/fuel/oil filter	42
51 96501 0414	94865	O-ring – engine/variou	36
51 96501 0415	6809	O-ring/seal ring – engine/fuel/oil filter	43

OEM-no.	dph-no.	description	page
51 96501 0417	4570	Cylinder liner sealing ring	18
51 96501 0417	4570	O-ring/seal ring – engine/fuel/oil filter	42
51 96501 0422	34577	O-ring – engine/variou	36
51 96501 0429	32761	O-ring – engine/variou	36
51 96501 0464	110933	O-ring – engine/variou	36
51 96501 0487	94535	O-ring – engine/variou	36
51 96501 0489	110819	O-ring – engine/variou	36
51 96501 0493	111083	O-ring/engine – variou	50
51 96501 0495	110809	O-ring/engine – variou	50
51 96501 0500	111034	O-ring/engine – variou	50
51 96501 0502	110929	O-ring/engine – variou	50
51 96501 0507	110821	O-ring/engine – variou	50
51 96501 0518	110835	O-ring/engine – variou	51
51 96501 0522	111084	O-ring/engine – variou	51
51 96501 0524	110825	O-ring/engine – variou	51
51 96501 0525	110824	O-ring/engine – variou	51
51 96501 0526	110886	O-ring/engine – variou	51
51 96501 0536	110992	O-ring/engine – variou	51
51 96504 0157	97543	Oil pan gasket	27
81 05901 0009	33147	O-ring/engine – variou	51
81 05902 0044	111082	O-ring/engine – variou	51
81 08903 0089	94464	O-ring/engine – variou	51
81 11904 0044	61403	Sealing washer, copper/variou	41
81 11904 0045	36430	O-ring/engine – variou	51
81 12902 0070	110852	O-ring/engine – variou	51
81 12902 0071	110920	O-ring/engine – variou	51
81 30725 6027	94384	Clutch servo cylinder	65
81 30725 6031	94466	Clutch servo cylinder	65
81 61951 0046	110901	O-ring/engine – variou	51
81 61951 0047	110879	O-ring/engine – variou	51
81 61951 0048	110850	O-ring/engine – variou	51
81 96501 0000	98097	O-ring/engine – variou	51
81 96501 0002	80832	O-ring/engine – variou	51
81 96501 0026	94714	Oil seal for rear axle	70
81 96501 0136	35202	Oil seal for rear axle	70
81 96501 0288	3934	O-ring/engine – variou	51
81 96501 0306	35204	Transmission oil seal	64
81 96501 0388	35208	Transmission oil seal	64
81 96501 0396	35929	O-ring/engine – variou	51
81 96501 0407	6634	O-ring/engine – variou	44
81 96501 0411	51470	O-ring/engine – variou	51
81 96501 0412	33600	O-ring/engine – variou	44
81 96501 0445	35209	Transmission oil seal	64
81 96501 0446	35210	Transmission oil seal	64
81 96501 0448	35211	Transmission oil seal	64
81 96501 0472	80794	O-ring/engine – variou	51
81 96501 0477	35614	Oil seal – engine housing	31
81 96501 0521	35212	Transmission oil seal	64
81 96501 0537	110894	O-ring/engine – variou	51
81 96501 0577	68556	O-ring/engine – variou	52
81 96501 0582	68501	O-ring/engine – variou	52
81 96501 0595	111016	O-ring/engine – variou	52
81 96501 0662	6633	O-ring/engine – variou	52
81 96501 0671	34394	O-ring/engine – variou	52
81 96501 0682	111069	O-ring/engine – variou	52



OEM-no.	dph-no.	description	page
81 96501 0683	110916	O-ring/engine – variou	52
81 96501 0684	110978	O-ring/engine – variou	52
81 96501 0710	110808	O-ring/engine – variou	52
81 96501 0714	110975	O-ring/engine – variou	52
81 96501 0719	110997	O-ring/engine – variou	52
81 96501 0720	110988	O-ring/engine – variou	52
81 96501 0767	37175	O-ring/engine – variou	52
81 96501 0768	111081	O-ring/engine – variou	52
81 96501 0774	34395	O-ring/engine – variou	52
81 96501 0775	35784	O-ring/engine – variou	52
81 96501 0789	111004	O-ring/engine – variou	52
81 96501 0810	111024	O-ring/engine – variou	52
81 96501 0816	110882	O-ring/engine – variou	52
81 96501 0831	6632	O-ring/engine – variou	52
81 96501 0842	84396	Oil seal for front axle	68
81 96501 0843	84198	Oil seal for rear axle	70
81 96501 0860	109841	Oil seal for rear axle	70
81 96501 0861	6649	Oil seal for rear axle	70
81 96501 0864	96084	Transmission oil seal	64
81 96501 0890	110930	O-ring/engine – variou	52
81 96501 0899	110998	O-ring/engine – variou	52
81 96501 0900	110896	O-ring/engine – variou	53
81 96501 0901	111001	O-ring/engine – variou	53
81 96501 0918	111020	O-ring/engine – variou	53
81 96501 0919	110936	O-ring/engine – variou	53
81 96501 0920	110902	O-ring/engine – variou	53
81 96501 0922	111033	O-ring/engine – variou	53
81 96501 0924	111022	O-ring/engine – variou	53
81 96501 0941	95830	Oil seal for front axle	68
81 96501 0945	110976	O-ring/engine – variou	53
81 96501 0978	111059	O-ring/engine – variou	53
81 96501 0979	111026	O-ring/engine – variou	53
81 96501 0980	111045	O-ring/engine – variou	53
81 96501 6003	110979	O-ring/engine – variou	53
81 96502 0012	36772	O-ring/engine – variou	53
81 96502 0021	111060	O-ring/engine – variou	53
81 96502 0044	34360	O-ring/engine – variou	53
81 96502 0045	34266	O-ring/engine – variou	53
81 96502 0049	111085	O-ring/engine – variou	53
81 96502 0053	110908	O-ring/engine – variou	53
81 96502 0057	111018	O-ring/engine – variou	53
81 96502 0068	110939	O-ring/engine – variou	53
81 96502 0075	110883	O-ring/engine – variou	53
81 96502 0077	110917	O-ring/engine – variou	53
81 96502 0079	111017	O-ring/engine – variou	54
81 96502 0087	110885	O-ring/engine – variou	54
81 96502 0091	111088	O-ring/engine – variou	54
81 96502 0097	110858	O-ring/engine – variou	54
81 96502 0106	111000	O-ring/engine – variou	54
81 96502 0107	110812	O-ring/engine – variou	54
81 96502 0133	110925	O-ring/engine – variou	54
81 96502 0144	111080	O-ring/engine – variou	54
81 96502 0157	111023	O-ring/engine – variou	54
81 96502 0158	111078	O-ring/engine – variou	54
81 96502 0163	111028	O-ring/engine – variou	54

OEM-no.	dph-no.	description	page
81 96502 0175	50909	O-ring/engine – various	54
81 96502 0183	110851	O-ring/engine – various	54
81 96502 0185	110803	O-ring/engine – various	54
81 96502 0188	110928	O-ring/engine – various	54
81 96502 0201	84507	O-ring/engine – various	54
81 96502 0208	50681	Transmission oil seal	64
81 96502 0225	93757	Transmission oil seal	64
81 96502 0226	69158	Transmission oil seal	64
81 96502 0247	82737	Transmission oil seal	64
81 96502 0248	34634	Transmission oil seal	64
81 96502 0255	33153	O-ring/engine – various	54
81 96502 0278	111006	O-ring/engine – various	54
81 96502 0280	110811	O-ring/engine – various	54
81 96502 0284	111062	O-ring/engine – various	54
81 96502 0285	110817	O-ring/engine – various	54
81 96502 0288	110837	O-ring/engine – various	54
81 96502 0289	110832	O-ring/engine – various	55
81 96502 0300	110854	O-ring/engine – various	55
81 96502 0349	80059	Transmission oil seal	64
81 96502 0350	61236	Oil seal crankshaft	60
81 96502 0353	110892	O-ring/engine – various	55
81 96502 0356	93880	Oil seal – various	34
81 96502 0359	94696	O-ring/engine – various	55
81 96502 0367	110804	O-ring/engine – various	55
81 96502 0384	111068	O-ring/engine – various	55
81 96502 0441	111044	O-ring/engine – various	55
81 96502 0467	111095	O-ring/engine – various	55
81 96502 0468	111063	O-ring/engine – various	55
81 96502 0469	111035	O-ring/engine – various	55
81 96502 0470	111013	O-ring/engine – various	55
81 96502 0540	111005	O-ring/engine – various	55
81 96502 0560	111025	O-ring/engine – various	55
81 96502 0638	68557	O-ring/engine – various	55
81 96502 0644	111012	O-ring/engine – various	55
81 96502 0645	111010	O-ring/engine – various	55
81 96502 0663	110991	O-ring/engine – various	55
81 96502 0672	110989	O-ring/engine – various	55
81 96502 0680	110818	O-ring/engine – various	55
81 96502 0685	110855	O-ring/engine – various	55
81 96502 0761	93804	Transmission oil seal	64
81 96502 0767	110931	O-ring/engine – various	55
81 96502 0768	111073	O-ring/engine – various	55
81 96502 0771	94864	O-ring/engine – various	56
81 96502 0776	111097	O-ring/engine – various	56
81 96502 0787	110985	O-ring/engine – various	56
81 96502 0850	111027	O-ring/engine – various	56
81 96502 0876	110921	O-ring/engine – various	56
81 96502 0897	111066	O-ring/engine – various	56
81 96502 0944	111032	O-ring/engine – various	56
81 96502 0958	81582	O-ring/engine – various	56
81 96502 0990	111050	O-ring/engine – various	56
81 96502 0991	111079	O-ring/engine – various	56
81 96502 0994	110999	O-ring/engine – various	56
81 96502 0997	111014	O-ring/engine – various	56
81 96502 0998	111021	O-ring/engine – various	56



OEM-no.	dph-no.	description	page
81 96503 0020	111092	O-ring/engine – various	56
81 96503 0023	110932	O-ring/engine – various	56
81 96503 0032	111074	O-ring/engine – various	56
81 96503 0041	93741	O-ring/engine – various	56
81 96503 0055	111052	O-ring/engine – various	56
81 96503 0088	111065	O-ring/engine – various	56
81 96503 0089	111030	O-ring/engine – various	56
81 96503 0090	111096	O-ring/engine – various	56
81 96503 0099	110829	O-ring/engine – various	56
81 96503 0103	110904	O-ring/engine – various	57
81 96503 0107	110927	O-ring/engine – various	57
81 96503 0130	110899	O-ring/engine – various	57
81 96503 0137	111019	O-ring/engine – various	57
81 96503 0173	110888	O-ring/engine – various	57
81 96503 0211	111002	O-ring/engine – various	57
81 96503 0217	110903	O-ring/engine – various	57
81 96503 0221	110833	O-ring/engine – various	57
81 96503 0223	110987	O-ring/engine – various	57
81 96503 0224	111029	O-ring/engine – various	57
81 96503 0240	110938	O-ring/engine – various	57
81 96503 0243	111042	O-ring/engine – various	57
81 96503 0246	111067	O-ring/engine – various	57
81 96503 0249	111061	O-ring/engine – various	57
81 96503 0251	110820	O-ring/engine – various	57
81 96503 0252	110838	O-ring – engine/various	36
81 96503 0253	110881	O-ring – engine/various	36
81 96503 0254	110898	O-ring – engine/various	36
81 96503 0266	111031	O-ring – engine/various	36
81 96503 0267	110937	O-ring – engine/various	37
81 96503 0268	111007	O-ring – engine/various	37
81 96503 0269	111049	O-ring – engine/various	37
81 96503 0272	110853	O-ring – engine/various	37
81 96503 0274	111086	O-ring – engine/various	37
81 96503 0275	110926	O-ring – engine/various	37
81 96503 0276	111064	O-ring – engine/various	37
81 96503 0279	110995	O-ring – engine/various	37
81 96503 0286	110934	O-ring – engine/various	37
81 96503 0297	110986	O-ring – engine/various	37
81 96503 0307	111043	O-ring – engine/various	37
81 96503 0325	110981	O-ring – engine/various	37
81 96503 0359	110840	O-ring – engine/various	37
81 96503 0360	110857	O-ring – engine/various	37
81 96503 0370	111058	O-ring – engine/various	37
81 96503 0376	110843	O-ring – engine/various	37
81 96503 0396	110841	O-ring – engine/various	37
81 96503 0400	110834	O-ring – engine/various	37
81 96503 0406	111054	O-ring – engine/various	37
81 96503 0409	110982	O-ring – engine/various	37
81 96503 0410	110993	O-ring – engine/various	37
81 96503 0411	111056	O-ring – engine/various	37
81 96503 0412	111048	O-ring – engine/various	38
81 96503 0422	111071	O-ring – engine/various	38
81 96503 0425	110918	O-ring – engine/various	38
81 96503 0428	111051	O-ring – engine/various	38
81 96503 0438	111053	O-ring – engine/various	38

Engine gaskets and gasket sets

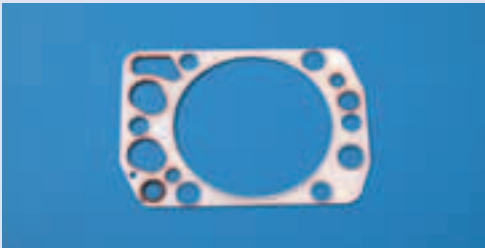

Cylinder head gasket

dph-no.	OEM-no.	application	
96539	51 03901 0285		
96510	51 03901 0298 51 03901 0275 (steel multi layer)		
94931	(rubber/metal)		
			<p>D2024 MF, 66 kW 4 cyl. 102 dia, from 1980</p> <p>D2026 M/MF/MFA 100kW, 6 cyl. dia. 102 from 1980</p> <p>D2026 MKF/MC/MCFO 125/141 kW 6 cyl. dia 102 from 1984 3 pcs. required</p> <p>D2542 MT/ME with re-inforced bushing 12 cyl. dia. 125</p> <p>D2542 ME with re-inforced bushing, exhaust water-cooled, from engine 4704650001 12 cyl. dia. 125</p> <p>D2542 MLE exhaust not-cooled, without air-pressure, from engine 4904675003 12 cyl. dia. 125</p> <p>D2542 MLE with re-inforced bushing, exhaust water-cooled from engine 4904675003 12 cyl. dia. 125</p> <p>D2542 MTE with re-inforced bushing, exhaust water-cooled, from engine 48046540006 12 cyl. dia. 125</p> <p>D2840 LE/LF 338kW/LF01/04/06/20/21/LXE/ME exhaust water-cooled 10 cyl. dia. 128</p> <p>D2840 MF/MFR/MH 10 cyl. dia. 128</p> <p>D2842 LXE/LYE/LYZ/LEE + D2842 ME exhaust water-cooled 12 cyl. dia. 128</p> <p>D2848 LE/LXE/M 8 cyl. dia. 128</p> <p>D2865 LF/LFR/LXF/LXFR/LF01../LF21-24, LFR01.. LOH01/02/05/07-09 5 cyl. dia. 128</p> <p>D2865 LU 01-03 5 cyl. dia. 128</p> <p>D2865 LUH02/03/05-09 5 cyl. dia. 128</p> <p>D2866 F/FR, DOH01/DF01 D2866 FZR/FG/OH D2866 KF/KFZ/KH/KOH, LOH02/03/06/07, LXOH, LF02-10/14-16, LFZ/LFZR, LH01-02/LXF D2866 LF20/21/22, LF29/30 D2866 LE/TE 6 cyl. dia. 128</p> <p>D2866 UH/UM/TUH/TUM/KUH/KUL/LXU/LU/LUL/LUH 6 cyl. dia. 128</p> <p>D2866 LUH20/21/22/26 6 cyl. dia. 128</p>
			<p>D2542 E with re-inforced bushing, from engine 4702001, 12 cyl. dia. 125 12 pcs required</p> <p>D2530 ME with re-inforced bushing, Exhaust not cooled, 10 cyl. dia. 125 10 pcs required</p> <p>D2530 MTE with re-inforced bushing, exhaust not cooled engine 4304585019 engine 4304590012 engine 4304614046 10 cyl. dia. 125 10 pcs required</p> <p>D2530 MTE with re-inforced bushing, exhaust water-cooled engine 4304585019 engine 4304590012 engine 4304614046 from engine 4304759011 10 cyl. dia. 125</p> <p>D2530 ME with re-inforced bushing exhaust water-cooled 10 cyl. dia. 125</p> <p>D2530 MXF/MXFR with re-inforced bushing, exhaust not-cooled, 10 cyl 125 dia</p> <p>D2538 MTE with re-inforced bushing, from engine 4655076, 8 cyl. dia. 125</p> <p>D2540 MLE with re-inforced bushing, exhaust water-cooled, from engine 4534610068, 10 cyl. dia. 125</p> <p>D2540 MTE with re-inforced bushing engine 4514598038 engine 4514598039 engine 4514598040 from engine 4514615058 10 cyl. dia. 125</p> <p>D2540 MTF/MTH with re-inforced bushing from engine 4584607064, 10 cyl. dia. 125</p>



Cylinder head gasket

dph-no.	OEM-no.	application
93642	51 03901 0338	
94931	51 03901 0356	D2876 LF01/LF02/LOH01 6 cyl. Dia 128
94930 96511	51 03901 0342 51 03901 0262 (steel multi layer)	 D2540 MTF/MTH up to engine 4584607063 10 cyl. dia. 125 10 pcs required D2530 ME , oil filter reversible, exhaust not-cooled, 10 cyl. dia. 125 10 pcs required D2530 MF/MXH/MXF/MXFR 235 kW, 10 cyl. dia. 125 from 1971 10 pcs required D2538 M/MF 189kW, 8 cyl. dia. 125 from 1972, 8 pcs required D2538 ME with re-inforced bushing, from engine 465507, 8 cyl. dia 125 D2538 ME/MTE oil filter reversible exhaust not-cooled, 8 cyl. dia. 125 D2566 MUH from engine 3294091103 D2566 MUM from engine 3394097095 6 cyl. dia. 125 D2542 ME oil filter reversible, exhaust not-cooled, 12 cyl. dia. 125 D2542 MLE 12 cyl. dia. 125 dia D2542 MTE oil filter reversible exhaust not-cooled, 12 cyl. dia. 125 D2555 M/MF/MX/MXF 5 cyl. dia. 125 D2555 MXE without air-compressor, exhaust cooled, fuel filter not reversible 5 cyl. dia. 125 D2555 MXUH/MXUL D2565 MXUH/MXUL up to engine 4135000, 5 cyl. dia. 125 D2565 M/MF/MFR/MH/MHO/MR 5 cyl. dia. 125 D2565 ME without air-compressor, exhaust not-cooled, 5 cyl. dia. 125 D2556 MXUH/MXUM up to engine 4091102 D2566 MUM from engine 4095094 D2566 UH/UH-200/UM 6cyl. dia. 125 D2566 M/MR/MF/MFR up to engine 4091059 D2566 MFG up to engine 4092000 D2566 MFO/FMOR up to engine 4093057 D2566 MH/MHO up to engine 4092102 6 cyl. dia. 125 D2566 M/MR/MF/MFR/MFO/MFOR from engine 4099001 6 cyl. dia. 125 D2566 ME from engine 4094086 D2566 MTE from engine 4069119 6 cyl. dia. 125 D2566 MFG from engine 4092001 6 cyl. dia. 125 D2566 MK/MKF/MKH/MK-Sibmas 1 cyl air-compressor 6 cyl. dia. 125 D2566 MLE exhaust not-cooled 6 cyl. dia. 125 D2566 MLUM USA/Canada 6 cyl. dia. 125 D2566 MT/MTF/MTH/MTHO/MTFG 6 cyl. dia. 125 D2566 MTUE/MTUH/MTUM USA 6 cyl. dia. 125 E2542 E exhaust water-cooled, oil filter not reversible 12 cyl. dia. 125 E2542E exhaust not-cooled, oil filter not reversible 12 cyl. dia. 125
96541	51 03901 0357	
109695	51 03901 0379	



Cylinder head gasket set

dph-no.	OEM-no.	application
81193	51 00900 6570	 <p>D2540 MTF/MTH up to engine 4584607063 10 cyl. dia. 125</p> <p>D2530 ME, oil filter reversible, exhaust not-cooled, 10 cyl. dia. 125 D2530 MF/MXH/MXF/MXFR 235 kW, 10 cyl. dia. 125 from 1971</p> <p>D2538 M/MF 189kW, 8 cyl. dia. 125 from 1972</p> <p>D2538 ME/MTE oil filter reversible, exhaust not-cooled, 8 cyl. dia. 125</p> <p>D2538 MT, 237kW, 8 cyl. dia. 125 from 1973</p> <p>D2566 MUH from engine 3294091103 D2566 MUM from engine 3394097095 6 cyl. dia. 125</p> <p>D2542 ME oil filter reversible, exhaust not-cooled, 12 cyl. dia. 125</p> <p>D2542 MLE 12 cyl. dia. 125 dia</p> <p>D2542 MTE oil filter reversible, exhaust not-cooled, 12 cyl. dia. 125</p> <p>D2555 M/MF/MX/MXF 5 cyl. dia. 125</p> <p>D2555 MXE without air-compressor, exhaust not-cooled, fuel filter not reversible 5 cyl. dia. 125</p> <p>D2555 MXUH/MXUL</p> <p>D2565 MXUH/MXUL up to engine 4135000, 5 cyl. dia. 125 D2565 M/MF/MFR/MH/MHO/MR 5 cyl. dia. 125</p> <p>D2565 ME without air-compressor, exhaust not-cooled 5 cyl. dia. 125</p> <p>D2556 MXUH/MXUM up to engine 4091102</p> <p>D2566 MUM from engine 4095094 D2566 UH/UH-200/UM 6cyl. dia. 125</p> <p>D2566 M/MR/MF/MFR up to engine 4091059 D2566 MFG up to engine 4092000 D2566 MFO/FMOR up to engine 4093057 D2566 MH/MHO up to engine 4092102 6 cyl. dia. 125</p> <p>D2566 M/MR/MF/MFR/MFO/MFOR from engine 4099001 6 cyl. dia. 125</p> <p>D2566 ME from engine 4094086 D2566 MTE from engine 4069119 6 cyl. dia. 125</p> <p>D2566 MFG from engine 4092001 6 cyl. dia. 125</p> <p>D2566 MK/MKF/MKH/MK-Sibmas 1 cyl, air-compressor 6 cyl. dia. 125</p> <p>D2566 MLE exhaust not-cooled 6 cyl. dia. 125</p> <p>D2566 MLUM USA/Canada 6 cyl. dia. 125</p> <p>D2566 MT/MTF/MTH/MTHO/MTFG 6 cyl. dia. 125</p> <p>D2566 MTUE/MTUH/MTUM USA 6 cyl. dia. 125</p>
109693	51 00900 6628	D0836 LFLO1 6 cyl. dia. 108
109287	51 00900 6630	 <p>D 2866</p>
96540	51 00900 6424	 <p>D 0224 MF, 66 kW 4 cyl. 102 dia., from 1980</p> <p>D0226 M/MF/MFA 100kW, 6 cyl. dia. 102 from 1980</p> <p>D0226 MKF/MC/MCFO 125/141 kW 6 cyl. dia 102 from 1984 3 pcs required</p>

Cylinder head gasket set

dph-no.	OEM-no.	application
96542	51 00900 6550	 <p>D0824 4 cyl. dia. 108 D0824 GF 75kW, 4 cyl. 108 dia from 1987</p> <p>D0826 6 cyl. dia. 108 D0826 6 cyl. dia. 108 with crank-case cover</p>
81542	51 00900 6558	 <p>D2530 ME with re-inforced bushing, exhaust not-cooled, 10 cyl. dia. 125 10 pcs required D2530 MTE with re-inforced bushing, exhaust not-cooled engine 4304585019 engine 4304590012 engine 4304614046 10 cyl. dia. 125 D2530 MTE with re-inforced bushing, exhaust water-cooled engine 4304585019 engine 4304590012 engine 4304614046 from engine 4304759011 10 cyl. dia. 125 D2530 ME with re-inforced bushing, exhaust water-cooled 10 cyl. dia. 125 D2530 MXF/MXFR with re-inforced bushing, exhaust not-cooled 10 cyl 125 dia</p> <p>D2538 ME with re-inforced bushing, from engine 4655076, 8 cyl. Dia 125 D2538 MTE with re-inforced bushing, from engine 4655076, 8 cyl. dia. 125</p> <p>D2540 MLE with re-inforced bushing, exhaust water-cooled, from engine 4534610068, 10 cyl. dia. 125# D2540 MTE with re-inforced bushing, engine 4514598038 engine 4514598039 engine 4514598040 from engine 4514615058 10 cyl. dia. 125 D2540 MTF/MTH with re-inforced bushing, from engine 4584607064, 10 cyl. dia. 125</p> <p>D2542 MT/ME with re-inforced bushing, 12 cyl. dia. 125 D2542 ME with re-inforced bushing, exhaust water-cooled, from engine 4704650001 12 cyl. dia. 125 D2542 MLE exhaust not-cooled, without air-compressor, from engine 4904675003 12 cyl. dia. 125 D2542 MLE with re-inforced bushing, exhaust water-cooled from engine 4904675003 12 cyl. dia. 125 D2542 MTE with re-inforced bushing, exhaust water-cooled, from engine 48046540006 12 cyl. dia. 125 D2542 E with re-inforced bushing, from engine 4702001, 12 cyl. dia. 125 E2542 E exhaust water-cooled, oil filter not reversible 12 cyl. dia. 125 E2542 E exhaust not-cooled oil filter reversible 12 cyl. dia. 125</p> <p>D2840 LE/LF 338kW/LF01/04/06/20/21/LXE/ME exhaust water cooled D2840 MF/MFR/MH 10 cyl. dia. 128</p> <p>D2842 LXE/LYE/LYZ/LEE + D2842 ME exhaust water cooled 12 cyl. dia. 128</p> <p>D2848 LE/LXE/M 8 cyl. dia. 128</p> <p>D2865 LF/LFR/LXF/LXFR/LF01../LF21-24, LFR01.. LOH01/02/05/07-09 5 cyl. dia. 128 D2865 LUH02/03/05-09 5 cyl. dia. 128</p> <p>D2866 F/FR, DOH01/DF01 D2866 FZR/FG/OH D2866 KF/KFZ/KH/KOH, LOH02/03/06/07, LXOH, LF02-10/14-16, LFZ/LFZR, LH01-02/LXF D2866 LF20/21/22, LF29/30 D2866 LE/TE 6 cyl. dia. 128 D2866 UH/UM/TUH/TUM/KUH/KUL/LXU/LU/LUL/LUH 6 cyl. dia. 128 D2866 LUH20/21/22/26 6 cyl. dia. 128</p> <p>D2876 LF01/LF02/LOH01 6 cyl. Dia 128</p>

Cylinder head gasket set

dph-no.	OEM-no.	application
109694	51 00900 6629	 <p>D2530 MXF/MXFR with re-inforced bushing, exhaust not-cooled 10 cyl 125 dia</p> <p>D2542 MT/ME with re-inforced bushing, 12 cyl. dia. 125</p> <p>D2542 ME with re-inforced bushing, exhaust water-cooled, from engine 4704650001 12 cyl. dia. 125</p> <p>D2542 MLE exhaust not-cooled without air-compressor, from engine 4904675003 12 cyl. dia. 125</p> <p>D2542 MLE with re-inforced bushing, exhaust water-cooled from engine 4904675003 12 cyl. dia. 125</p> <p>D2542 MTE with re-inforced bushing, exhaust water-cooled, from engine 48046540006 12 cyl. dia. 125</p> <p>D2542 E with re-inforced bushing, from engine 4702001 12 cyl. dia. 125</p> <p>D2840 LE/LF 338kW/LF01/04/06/20/21/LXE/ME exhaust water-cooled</p> <p>D2840 MF/MFR/MH 10 cyl. dia. 128</p> <p>D2842 LXE/LYE/LYZ/LEE + D2842 ME exhaust water-cooled 12 cyl. dia. 128</p> <p>D2848 LE/LXE/M 8 cyl. dia. 128</p> <p>D2865 LF/LFR/LXF/LXFR/LF01.../LF21-24, LFR01.. LOH01/02/05/07-09 5 cyl. dia. 128</p> <p>D2865 LUH02/03/05-09 5 cyl. dia. 128</p> <p>D2866 F/FR, DOH01/DF01</p> <p>D2866 FZR/FG/OH</p> <p>D2866 KF/KFZ/KH/KOH, LOH02/03/06/07, LXOH, LF02-10/14-16, LFZ/LFZR, LH01-02/LXF</p> <p>D2866 LF20/21/22, LF29/30</p> <p>D2866 LE/TE 6 cyl. dia. 128</p> <p>D2866 UH/UM/TUH/TUM/KUH/KUL/LXU/LU/LUL/LUH 6 cyl. dia. 128</p> <p>D2866 LUH20/21/22/26 6 cyl. dia. 128</p> <p>D2530 ME, with re-inforced bushing, exhaust not-cooled, 10 cyl. dia. 125 10 pcs required</p> <p>D2530 MTE with re-inforced bushing, exhaust not-cooled, engine 4304585019 engine 4304590012 engine 4304614046 10 cyl. dia. 125 10 pcs required</p> <p>D2530 MTE with re-inforced bushing, exhaust water-cooled engine 4304585019 engine 4304590012 engine 4304614046 from engine 4304759011 10 cyl. dia. 125</p> <p>D2530 ME with re-inforced bushing, exhaust water-cooled, 10 cyl. dia. 125</p> <p>D2538 ME with re-inforced bushing, from engine 465507, 8 cyl. Dia 125</p> <p>D2538 MTE with re-inforced bushing, from engine 4655076, 8 cyl. dia. 125</p> <p>D2540 MLE with re-inforced bushing, exhaust water-cooled, from engine 4534610068, 10 cyl. dia. 125</p> <p>D2540 MTE with re-inforced bushing, engine 4514598038 engine 4514598039 engine 4514598040 from engine 4514615058 10 cyl. dia. 125</p> <p>D2540 MTF/MTH with re-inforced bushing, from engine 4584607064, 10 cyl. dia. 125</p>
95899	93 21014 0021	 <p>E2542 E with re-inforced bushing, exhaust water-cooled, from engine 4702001 12 cyl. dia. 125</p>

95899 93 21014 0021



E2542 E with re-inforced bushing, exhaust water-cooled, from engine 4702001 12 cyl. dia. 125

Valve stem seal

dph-no.	OEM-no.	application
51314	51 04902 0028	 <p>D2876 LF01/LF02/LOH01 6 cyl. dia 128 exhaust valve, 6 pcs required</p>

Valve stem seal

dph-no.	OEM-no.	application
82878	51 04902 0008	
4705	51 04902 0023	

Cylinder liner sealing ring

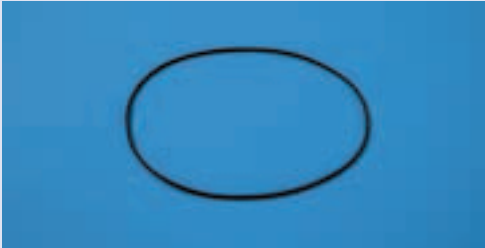
dph-no.	OEM-no.	application
4570	51 96501 0417	 <p>Size : 138 x 2,1 FPM black</p> <p>D2530 ME, oil filter reversible exhaust not-cooled, 10 cyl. dia. 125 20 pcs required, top</p> <p>D2530 ME with re-inforced bushing, exhaust not-cooled, 10 cyl. dia. 125 20 pcs required, top</p> <p>D2540 MTF/MTH up to engine 4584607063 10 cyl. dia. 125 20 pcs required, top</p> <p>D2530 MF/MXH/MXF/MXFR 235 kW, 10 cyl. dia. 125 from 1971 20 pcs required, top</p> <p>D2530 MTE with re-inforced bushing, exhaust not-cooled, engine 4304585019 engine 4304590012 engine 4304614046 10 cyl. dia. 125</p> <p>D2530 MTE with re-inforced bushing, exhaust water-cooled, engine 4304585019 engine 4304590012 engine 4304614046 from engine 4304759011 10 cyl. dia. 125</p> <p>D2530 ME with re-inforced bushing, exhaust water-cooled, 10 cyl. dia. 125</p> <p>D2538 M/MF 189kW, 8 cyl. dia. 125 from 1972, 16 pcs required, top</p> <p>D2538 ME with re-inforced bushing, from engine 465507, 8 cyl. dia. 125 16 pcs required, top</p> <p>D2538 ME/MTE oil filter reversible exhaust not-cooled, 8 cyl. dia. 125 16 pcs required, top</p> <p>D2538 MT, 237kW, 8 cyl. dia. 125 from 1973</p> <p>D2538 MTE with re-inforced bushing, from engine 4655076, 8 cyl. dia. 125</p> <p>D2540 MLE with re-inforced bushing, exhaust water-cooled, from engine 4534610068, 10 cyl. dia. 125</p> <p>D2540 MTE with re-inforced bushing, engine 4514598038 engine 4514598039 engine 4514598040 from engine 4514615058 10 cyl. dia. 125</p> <p>D2540 MTF/MTH with re-inforced bushing, from engine 4584607064, 10 cyl. dia. 125</p> <p>D2530 MXF/MXFR with re-inforced bushing, exhaust not-cooled, 10 cyl 125 dia</p> <p>D2566 MUH from engine 3294091103 D2566 MUM from engine 3394097095 6 cyl. dia. 125</p> <p>D2542 MT/ME with re-inforced bushing, 12 cyl. dia. 125</p> <p>D2542 ME oil filter reversible exhaust not-cooled, 12 cyl. dia. 125</p> <p>D2542 ME with re-inforced bushing, exhaust water-cooled, from engine 4704650001 12 cyl. dia. 125</p> <p>D2542 MLE exhaust not-cooled, without air-compressor, from engine 4904675003 12 cyl. dia. 125</p> <p>D2542 MLE with re-inforced bushing, exhaust water-cooled from engine 4904675003 12 cyl. dia. 125</p> <p>D2542 MLE 12 cyl. dia. 125 dia</p> <p>D2542 MTE with re-inforced bushing, exhaust water-cooled, from engine 48046540006 12 cyl. dia. 125</p> <p>D2542 MTE oil filter reversible exhaust not-cooled, 12 cyl. dia. 125</p> <p>D2555 M/MF/MX/MXF 5 cyl. dia. 125</p> <p>D2555 MXE without air-compressor, exhaust not cooled, fuel filter not reversible 5 cyl. dia. 125</p>



Cylinder liner sealing ring

dph-no.	OEM-no.	application
		<p>D2555 MXUH/MXUL D2565 MXUH/MXUL up to engine 4135000, 5 cyl. dia. 125 D2565 M/MF/MFR/MH/MHO/MR 5 cyl. dia. 125 D2565 ME without air-compressor, exhaust not-cooled 5 cyl. dia. 125 D2556 MXUH/MXUM up to engine 4091102 D2566 MUM from engine 4095094 D2566 UH/UH-200/UM 6cyl. dia. 125 D2566 M/MR/MF/MFR up to engine 4091059 D2566 MFG up to engine 4092000 D2566 MFO/FMOR up to engine 4093057 D2566 MH/MHO up to engine 4092102 6 cyl. dia. 125</p> <p>D2566 M/MR/MF/MFR/MFO/MFOR from engine 4099001 6 cyl. dia. 125 D2566 ME from engine 4094086 D25566 MTE from engine 4069119 6 cyl. dia. 125</p> <p>D2566 MFG from engine 4092001 6 cyl. dia. 125 D2566 MK/MKF/MKH/MK-Sibmas 1 cyl. air-compressor 6 cyl. dia. 125 D2566 MLE exhaust not-cooled 6 cyl. dia. 125</p> <p>D2566 MLUM USA/Canada 6 cyl. dia. 125 D2566 MT/MTF/MTH/MTHO/MTFG 6 cyl. dia. 125 D2566 MTUE/MTUH/MTUM USA 6 cyl. dia. 125</p> <p>D2840 LE/LF 338kW/LF01/04/06/20/21/LXE/ME exhaust water-cooled D2840 MF/MFR/MH 10 cyl. dia. 128</p>
		<p>D2842 LXE/LYE/LYZ/LEE + D2842 ME exhaust water-cooled 12 cyl. dia. 128</p> <p>D2848 LE/LXE/M 8 cyl. dia. 128</p> <p>D2865 LF/LFR/LXF/LXFR/LF01../LF21-24, LFR01.. LOH01/02/05/07-09 5 cyl. dia. 128 D2865 LU 01-03 5 cyl. dia. 128 D2865 LUH02/03/05-09 5 cyl. dia. 128</p> <p>D2866 F/FR, DOH01/DF01 D2866 FZR/FG/OH D2866 KF/KFZ/KH/KOH, LOH02/03/06/07, LXOH, LF02-10/14-16, LFZ/LFZR, LH01-02/LXF D2866 LF20/21/22, LF29/30 D2866 LE/TE 6 cyl. dia. 128 D2866 UH/UM/TUH/TUM/KUH/KUL/LXU/LU/LUL/LUH 6 cyl. dia. 128 D2866 LUH20/21/22/26 6 cyl. dia. 128</p> <p>D2876 LF01/LF02/LOH01 6 cyl. dia. 128</p> <p>E2542 E with re-inforced bushing, exhaust water-cooled, from engine 4702001 12 cyl. dia. 125 E2542 E exhaust water-cooled oil filter not reversible 12 cyl. dia. 125 E2542 E exhaust not-cooled oil filter not reversible 12 cyl. dia. 125</p>
4571 6678	51 96501 0357 06 56937 3914	<p>Size: 140 x 4 FPM green</p> <p>D2530 ME, oil filter reversible exhaust not-cooled, 10 cyl. dia. 125 20 pcs required, bottom</p> <p>D2540 MTF/MTH up to engine 4584607063 10 cyl. dia. 125 20 pcs required, bottom D2530 MF/MXH/MXF/MXFR 235 kW, 10 cyl. dia. 125 from 1971 20 pcs required, bottom</p> <p>D2538 M/MF 189kW, 8 cyl. dia. 125 from 1972, 16 pcs required, bottom D2538 ME/MTE oil filter reversible exhaust not-cooled, 8 cyl. dia. 125 16 pcs required, bottom</p> <p>D2538 MT, 237kW, 8 cyl. dia. 125 from 1973</p> <p>D2566 MUH from engine 3294091103 D2566 MUM from engine 3394097095 6 cyl. dia. 125</p> <p>D2542 ME oil filter reversible Exhaust not-cooled, 12 cyl. dia. 125 D2542 MLE 12 cyl. dia. 125 dia D2542MTE oil filter reversible Exhaust not-cooled, 12 cyl. dia. 125</p>
		<p>D2555 M/MF/MX/MXF 5 cyl. dia. 125 D2555 MXE without air-compressor exhaust not-cooled, oil filter not reversible 5 cyl. dia. 125</p> <p>D2555 MXUH/MXUL D2565 MXUH/MXUL up to engine 4135000, 5 cyl. dia. 125 D2565 M/MF/MFR/MH/MHO/MR 5 cyl. dia. 125 D2565ME without air-compressor exhaust not-cooled 5 cyl. dia. 125 D2556 MXUH/MXUM up to engine 4091102 D2566 MUM from engine 4095094 D2566 UH/UH-200/UM 6cyl. dia. 125 D2566 M/MR/MF/MFR up to engine 4091059 D2566 MFG up to engine 4092000 D2566 MFO/FMOR up to engine 4093057 D2566 MH/MHO up to engine 4092102 6 cyl. dia. 125</p> <p>D2566 M/MR/MF/MFR/MFO/MFOR from engine 4099001 6 cyl. dia. 125</p> <p>D2566 ME from engine 4094086 D25566 MTE from engine 4069119 6 cyl. dia. 125</p>

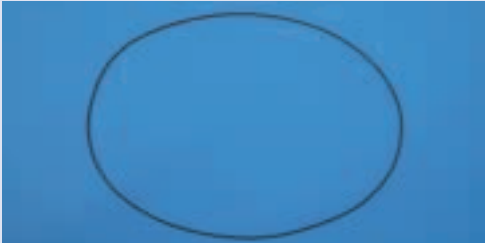



Cylinder liner sealing ring

dph-no.	OEM-no.	application
		<p>D2566 MFG from engine 4092001 6 cyl. dia. 125</p> <p>D2566 MK/MKF/MKH/MK-Sibmas 1 cyl air-compressor 6 cyl. dia. 125</p> <p>D2566MLE exhaust not-cooled 6 cyl. dia. 125</p> <p>D2566 MLUM USA/Canada 6 cyl. dia. 125</p>
		<p>D2566 MT/MTF/MTH/MTHO/MTFG 6 cyl. dia. 125</p> <p>D2566 MTUE/MTUH/MTUM USA 6 cyl. dia. 125</p> <p>E2542 E exhaust water-cooled oil filter not reversible 12 cyl. dia. 125</p> <p>E2542 E exhaust not-cooled oil filter reversible 12 cyl. dia. 125</p>
6688	51 96501 0412	 <p>Size: 144 x 4 FPM green</p> <p>D2530 ME with re-inforced bushing, exhaust not-cooled, 10 cyl. dia. 125 20 pcs required, bottom</p> <p>D2530 MTE with re-inforced bushing, exhaust not-cooled engine 4304585019 engine 4304590012 engine 4304614046 10 cyl. dia. 125</p> <p>D2530 MTE with re-inforced bushing, exhaust water-cooled engine 4304585019 engine 4304590012 engine 4304614046 from engine 4304759011 10 cyl. dia. 125</p> <p>D2530 ME with re-inforced bushing, exhaust water-cooled, 10 cyl. dia. 125</p> <p>D2538 ME with re-inforced bushing, from engine 465507, 8 cyl. Dia 125 16 pcs required, bottom</p> <p>D2538 MTE with re-inforced bushing, from engine 4655076, 8 cyl. dia. 125</p> <p>D2540 MLE with re-inforced bushing, exhaust water cooled, from engine 4534610068, 10 cyl. dia. 125</p> <p>D2540 MTE with re-inforced bushing, engine 4514598038 engine 4514598039 engine 4514598040 from engine 4514615058 10 cyl. dia. 125</p> <p>D2540 MTF/MTH with re-inforced bushing, from engine 4584607064, 10 cyl. dia. 125</p> <p>D2530 MXF/MXFR with re-inforced bushing, exhaust not-cooled, 10 cyl 125 dia</p> <p>D2542 MT/ME with re-inforced bushing, 12 cyl. dia. 125</p>
		<p>D2542 ME with re-inforced bushing, exhaust water-cooled, from engine 4704650001 12 cyl. dia. 125</p> <p>D2542 MLE exhaust not-cooled, without air-compressor, from engine 4904675003 12 cyl. dia. 125</p> <p>D2542 MLE with re-inforced bushing, exhaust water-cooled from engine 4904675003 12 cyl. dia. 125</p> <p>D2542 MTE with re-inforced bushing, exhaust water-cooled, from engine 48046540006 12 cyl. dia. 125</p> <p>D2840 LE/LF 338kW/LF01/04/06/20/21/LXE/ME exhaust water cooled</p> <p>D2840 MF/MFR/MH 10 cyl. dia. 128</p> <p>D2842 LXE/LYE/LYZ/LEE + D2842 ME Exhaust water-cooled 12 cyl. dia. 128</p> <p>D2848 LE/LXE/M 8 cyl. dia. 128</p> <p>D2865 LF/LFR/LXF/LXFR/LF01../LF21-24, LFR01.. LOH01/02/05/07-09 5 cyl. dia. 128</p> <p>D2865 LU 01-03 5 cyl. dia. 128</p> <p>D2865 LUH02/03/05-09 5 cyl. dia. 128</p> <p>D2866 F/FR, DOH01/DF01 D2866 FZR/FG/OH D2866 KF/KFZ/KH/KOH, LOH02/03/06/07, LXOH, LF02-10/14-16, LFZ/LFZR, LH01-02/LXF</p> <p>D2866 LF20/21/22, LF29/30 D2866 LE/TE 6 cyl. dia. 128</p> <p>D2866 UH/UM/TUH/TUM/KUH/KUL/LXU/LU/LUL/LUH 6 cyl. dia. 128</p> <p>D2866 LUH20/21/22/26 6 cyl. dia. 128</p> <p>D2876 LF01/LF02/LOH01 6 cyl. Dia 128</p> <p>E2542 E with re-inforced bushing, exhaust water-cooled, from engine 4702001 12 cyl. dia. 125</p>
34177	06 56349 0066	 <p>Size: 295 x 2, 4 FPM black</p>



Cylinder liner sealing ring

dph-no.	OEM-no.	application	
35291 6687	51 96501 0263 51 96501 0409		Size: 140 x 4 NBR black
6685	51 96501 0338		Size: 138 x 2, 10 FPM green
4714	51 96501 0346		Size: 138 x 3,5 FPM green

Cylinder liner sealing ring kit

dph-no.	OEM-no.	application	
84658	MAN 125 mm		Contents: 2 pcs of 140 x 4 FPM green 2 pcs of 138 x 2,10 FPM black
98298	MAN 125 mm		Contents: 12 pcs of 138 x 2,10 NBR black 12 pcs of 138 x 4 NBR green For 6 cyl.
97949	MAN 125 mm		Contents: 2 pcs of 140 x 4 FPM green 2 pcs of 138 x 2,1 FPM green
50847	MAN 128 mm		Contents: 2 pcs of 144 x 4 FPM green 2 pcs of 138 x 2,1 FPM black

Cylinder liner sealing ring kit

dph-no.	OEM-no.	application	
104117	MAN 128 mm		<p>Contents: 12 pcs of 138 x 2,10 NBR black 12 pcs of 144 x 4 FPM green</p> <p>For 6 cyl.</p>
97950	MAN 128 mm		<p>Contents: 2 pcs of 144 x 4 FPM green 2 pcs of 138 x 2,1 FPM green</p>

Full set

dph-no.	OEM-no.	application	
84627	51 00900 6404		<p>D0226 MKF/MC/MCFO 125/141 kW 6 cyl. dia 102 from 1984</p>
98566	51 00900 6456		<p>D2556 MXUH/MXUM up to engine 4091102</p> <p>D2566 MUM from engine 4095094 D2566 UH/UH-200/UM 6 cyl. dia. 125</p>
96838	51 00900 6471		<p>D2566 MK/MKF/MKH/MK-Sibmas 1 cyl air-compressor 6 cyl. dia. 125</p>
96840	51 00900 6398		<p>Incl. oil seals – 6 cyl.</p>

Full set

dph-no.	OEM-no.	application
96839	51 00900 6458	 <p>Incl oil seals – 6 cyl.</p>

Valve cover gasket

dph-no.	OEM-no.	application
96263	51 03905 0148	 <p>D0224 MF, 4 cyl. 102 dia. 66 kW, from 1980</p> <p>D0226 M/MF/MFA 100kW, 6 cyl. dia. 102 from 1980</p> <p>D0226 MKF/MC/MCFO 125/141 kW 6 cyl. dia 102 from 1984</p> <p>D0226 MKF/MC/MCFO 125/141 kW 6 cyl. dia 102 from 1984 3 pcs required</p> <p>D0824 4 cyl. dia. 108 2 pcs. required</p> <p>D0824 GF 75kW, 4 cyl. 108 dia from 1987 2 pcs required</p> <p>D0826 6 cyl. dia. 108, 3 pcs required</p> <p>D0826 6 cyl. dia. 108 with crank-case cover, 3 pcs required</p>
109692	51 03905 0155	D0836 LFL01 6 cyl. dia. 108
68993	51 03905 0134	 <p>D2538 ME/MTE oil filter reversible exhaust not-cooled 8 cyl. dia. 125</p> <p>D2538 MT, 237kW, 8 cyl. dia. 125 from 1973</p> <p>D2538 MTE with re-inforced bushing, from engine 4655076, 8 cyl. dia. 125</p> <p>D2540 MLE with re-inforced bushing, exhaust water-cooled, from engine 4534610068, 10 cyl. dia. 125</p> <p>D2540 MTE with re-inforced bushing, engine 4514598038 engine 4514598039 engine 4514598040 from engine 4514615058 10 cyl. dia. 125</p> <p>D2540 MTF/MTH with re-inforced bushing, from engine 4584607064, 10 cyl. dia. 125</p> <p>D2530 MXF/MXFR with re-inforced bushing, exhaust not- cooled, 10 cyl 125 dia</p> <p>D2566 MUH from engine 3294091103 D2566 MUM from engine 3394097095 6 cyl. dia. 125</p> <p>D2542 MT/ME with re-inforced bushing, 12 cyl. dia. 125</p> <p>D2542 ME oil filter reversible, exhaust not-cooled, 12 cyl. dia. 125</p> <p>D2542 ME with re-inforced bushing, exhaust water cooled, from engine 4704650001 12 cyl. dia. 125</p> <p>D2542 MLE exhaust not-cooled, without air-compressor, from engine 4904675003 12 cyl. dia. 125</p>

Valve cover gasket

dph-no. OEM-no. application

D2542 MLE with re-inforced bushing, exhaust water cooled from engine 4904675003
12 cyl. dia. 125

D2542 MLE 12 cyl. dia. 125 dia
D2542 MTE with re-inforced bushing, exhaust water cooled, from engine 48046540006 12 cyl. dia. 125
D2542MTE oil filter reversible, exhaust not-cooled,
12 cyl. dia. 125

D2555 M/MF/MX/MXF
5 cyl. dia. 125
D2555 MXE without air-compressor, exhaust not cooled,
fuel filter not reversible
5 cyl. dia. 125
D2555 MXUH/MXUL

D2565 MXUH/MXUL
up to engine 4135000, 5 cyl. dia. 125
D2565 M/MF/MFR/MH/MHO/MR
5 cyl. dia. 125
D2565 ME without air-compressor,
exhaust not cooled, 5 cyl. dia. 125
D2556 MXUH/MXUM up to engine 4091102

D2566 MUM from engine 4095094
D2566 UH/UH-200/UM
6 cyl. dia. 125
D2566 M/MR/MF/MFR up to engine 4091059
D2566 MFG up to engine 4092000
D2566 MFO/FMOR up to engine 4093057
D2566 MH/MHO up to engine 4092102
6 cyl. dia. 125
D2566 M/MR/MF/MFR/MFO/MFOR from engine
4099001
6 cyl. dia. 125
D2566 ME from engine 4094086
D25566 MTE from engine 4069119
6 cyl. dia. 125

D2566 MFG from engine 4092001
6 cyl. dia. 125

D2566 MK/MKF/MKH/MK-Sibmas
1 cyl air-compressor
6 cyl. dia. 125
D2566 MLE exhaust not-cooled
6 cyl. dia. 125

D2566 MLUM USA/Canada
6 cyl. dia. 125
D2566 MT/MTF/MTH/MTHO/MTFG
6 cyl. dia. 125
D2566 MTUE/MTUH/MTUM USA
6 cyl. dia. 125

D2840 LE/LF 338kW/LF01/04/06/20/21/LXE/ME
exhaust water-cooled
D2840 MF/MFR/MH
10 cyl. dia. 128

D2842 LXE/LYE/LYZ/LEE + D2842 ME
exhaust water-cooled
12 cyl. dia. 128





D2848 LE/LXE/M
8 cyl. dia. 128

D2865 LF/LFR/LXF/LXFR/LF01../LF21-24, LFR01..
LOH01/02/05/07-09
5 cyl. dia. 128
D2865 LU 01-03
5 cyl. dia. 128
D2865 LUH02/03/05-09
5 cyl. dia. 128

D2866 F/FR, DOH01/DF01
D2866 FZR/FG/OH
D2866 KF/KFZ/KH/KOH, LOH02/03/06/07, LXOH,
LF02-10/14-16, LFZ/LFZR, LH01-02/LXF
D2866 LF20/21/22, LF29/30
D2866 LE/TE
6 cyl. dia. 128
D2866 UH/UM/TUH/TUM/KUH/KUL/LXU/LU/LUL/LUH
6 cyl. dia. 128
D2866 LUH20/21/22/26
6 cyl. dia. 128

D2876 LF01/LF02/LOH01
6 cyl. Dia 128

Valve cover gasket

dph-no.	OEM-no.	application
61251 70815	51 03905 0135 51 03905 0103	 <p>E2542 E with re-inforced bushing, exhaust water cooled, from engine 4702001 12 cyl. dia. 125 E2542 E exhaust water-cooled, oil filter not reversible 12 cyl. dia. 125 E2542 E exhaust not-cooled, oil filter reversible 12 cyl. dia. 125</p>
96328	51 03905 0108	
109810	51 03905 0157	
109811	51 03905 0161	
36179	51 01903 0166	





Oil pan gasket

dph-no.	OEM-no.	application
109876	51 05904 0171	<p>D0224 MF, 66kW, 4 cyl. 102 dia. from 1980</p> <p>D0824 4 cyl. dia. 108</p> <p>D0824 GF 75kW, 4 cyl. 108 dia from 1987</p>
96432	51 05904 0139	 <p>D0226 M/MF/MFA 100kW, 6 cyl. dia. 102 from 1980 D0226 MKF/MC/MCFO 125/141 kW 6 cyl. dia 102 from 1984</p> <p>D0826 6 cyl. dia. 108</p>

Oil pan gasket

dph-no.	OEM-no.	application	
84455	51 05904 0134	 <p>D2530 ME, oil filter reversible exhaust not-cooled, 10 cyl. dia. 125</p> <p>D2540 MTF/MTH up to engine 4584607063 10 cyl. dia. 125</p> <p>D2530 MF/MXH/MXF/MXFR 235 kW, 10 cyl. dia. 125 from 1971</p> <p>D2530 MTE with re-inforced bushing, exhaust not-cooled engine 4304585019 engine 4304590012 engine 4304614046 10 cyl. dia. 125</p> <p>D2530 MTE with re-inforced bushing, exhaust water-cooled engine 4304585019 engine 4304590012 engine 4304614046 from engine 4304759011 10 cyl. dia. 125</p>	<p>D2530 ME with re-inforced bushing, exhaust water-cooled. 10 cyl. dia. 125</p> <p>D2540 MLE with re-inforced bushing, Exhaust water-cooled, from engine 4534610068, 10 cyl. dia. 125</p> <p>D2540 MTE with re-inforced bushing, engine 4514598038 engine 4514598039 engine 4514598040 from engine 4514615058 10 cyl. dia. 125</p> <p>D2540 MTF/MTH with re-inforced bushing, from engine 4584607064, 10 cyl. dia. 125</p> <p>D2530 MXF/MXFR with re-inforced bushing, exhaust not-cooled, 10 cyl 125 dia</p> <p>D2840 LE/LF 338kW/LF01/04/06/20/21/LXE/ME exhaust water-cooled</p> <p>D2840 MF/MFR/MH 10 cyl. dia. 128</p>
		<p>D2542 E with re-inforced bushing, from engine 4702001, 12 cyl. dia. 125</p> <p>D2542 MT/ME with re-inforced bushing, 12 cyl. dia. 125</p> <p>D2542 ME oil filter reversible, exhaust not-cooled 12 cyl. dia. 125</p> <p>D2542 ME with re-inforced bushing, exhaust water-cooled, from engine 4704650001 12 cyl. dia. 125</p> <p>D2542 MLE exhaust not-cooled, without air-compressor, from engine 4904675003 12 cyl. dia. 125</p> <p>D2542 MLE with re-inforced bushing, exhaust water-cooled from engine 4904675003, 12 cyl. dia. 125</p>	<p>D2542 MLE 12 cyl. dia. 125 dia</p> <p>D2542 MTE with re-inforced bushing, exhaust water-cooled, from engine 48046540006, 12 cyl. dia. 125</p> <p>D2542MTE oil filter reversible, exhaust not-cooled, 12 cyl. dia. 125</p> <p>D2842 LXE/LYE/LYZ/LEE + D2842 ME Exhaust water-cooled 12 cyl. dia. 128</p> <p>E2542 E with re-inforced bushing, exhaust water-cooled, from engine 4702001 12 cyl. dia. 125</p> <p>E2542 E exhaust water-cooled, oil filter not reversible, 12 cyl. dia. 125</p>
97543	51 05904 0157	<p>D2538 M/MF 189kW, 8 cyl. dia. 125 from 1972</p> <p>D2538 ME with re-inforced bushing, from engine 465507, 8 cyl. dia 125</p> <p>D2538 ME/MTE oil filter reversible, exhaust not-cooled, 8 cyl. dia. 125</p> <p>D2538 MT, 237kW, 8 cyl. dia. 125 From 1973</p> <p>D2538 MTE with re-inforced bushing, from engine 4655076, 8 cyl. dia. 125</p>	<p>D2566 M/MR/MF/MFR up to engine 4091059 D2566 MFG up to engine 4092000 D2566 MFO/FMOR up to engine 4093057 D2566 MH/MHO up to engine 4092102 6 cyl. dia. 125</p> <p>D2848 LE/LXE/M 8 cyl. dia. 128</p>

Oil pan gasket

dph-no.	OEM-no.	application
59273 61052	51 05904 0132 51 05904 0083	 <p>D2566 MUH from engine 3294091103 D2566 MUM from engine 3394097095 6 cyl. dia. 125 D2556 MXUH/MXUM up to engine 4091102 D2566 MUM from engine 4095094 D2566 UH/UH-200/UM 6 cyl. dia. 125</p> <p>D2566 M/MR/MF/MFR/MFO/MFOR from engine 4099001 6 cyl. dia. 125 D2566 MFG from engine 4092001 6 cyl. dia. 125 D2566 MK/MKF/MKH/MK-Sibmas 1 cyl air-compressor 6 cyl. dia. 125</p>
		<p>D2566 MLUM USA/Canada 6 cyl. dia. 125</p> <p>D2566 MT/MTF/MTH/MTHO/MTFG 6 cyl. dia. 125 D2566 MTUE/MTUH/MTUM USA 6 cyl. dia. 125</p> <p>D2866 F/FR, DOH01/DF01 D2866 FZR/FG/OH D2866 KF/KFZ/KH/KOH, LOH02/03/06/07, LXOH, LF02-10/14-16, LFZ/LFZR, LH01-02/LXF D2866 LF20/21/22, LF29/30 D2866 LE/TE 6 cyl. dia. 128</p> <p>D2866 UH/UM/TUH/TUM/KUH/KUL/LXU/LU/LUL/LUH 6 cyl. dia. 128 D2866 LUH20/21/22/26 6 cyl. dia. 128 D2876 LF01/LF02/LOH01 6 cyl. Dia 128</p>
97750	51 05904 0131	 <p>D2555 M/MF/MX/MXF 5 cyl. dia. 125, 5 pcs required D2555 MXE without air-compressor, exhaust not-cooled, fuel filter not reversible 5 cyl. dia. 125 D2555 MXUH/MXUL</p> <p>D2565 MXUH/MXUL up to engine 4135000, 5 cyl. dia. 125 D2565 ME without air-compressor exhaust not-cooled 5 cyl. dia. 125</p> <p>D256ME from engine 4094086 D25566 MTE from engine 4069119 6 cyl. dia. 125 D2566 MLE exhaust not-cooled 6 cyl. dia. 125</p> <p>D2865 LF/LFR/LXF/LXFR/LF01../LF21-24, LFR01.. LOH01/02/05/07-09 5 cyl. dia. 128 D2865 LU 01-03 5 cyl. dia. 128 D2865 LUH02/03/05-09 5 cyl. dia. 128</p>
109544	51 05904 0198	
97543	51 96504 0157	

Manifold gasket – EXHAUST

dph-no. OEM-no. application

97113 51 08901 0027



D0224 MF, 66kW, 4 cyl. 102 dia. from 1980,
4 pcs required

D0226 M/MF/MFA
100kW, 6 cyl. dia. 102 from 1980

D0824

4 cyl. dia. 108, 4 pcs required

D0824 GF 75kW, 4 cyl. 108 dia from 1987
4 pcs required

D0826 6 cyl. dia. 108 6 pcs required

D0826 6 cyl. dia. 108 with crank-case cover
6 pcs required

D0836 LFL01 6 cyl. dia. 108, 6 pcs required

61060 51 08901 0023



D2530 ME, oil filter reversible
exhaust not-cooled
10 cyl. dia. 125, 10 pcs required

D2530 ME with re-inforced bushing,
exhaust not-cooled 10 cyl. dia. 125
10 pcs required

D2540 MTF/MTH up to engine 4584607063
10 cyl. dia. 125
10 pcs required

D2542 E with re-inforced bushing,
from engine 4702001, 12 cyl. dia. 125
12 pcs required

D2530 MF/MXH/MXF/MXFR
235 kW, 10 cyl. dia. 125 from 1971
10 pcs required

D2530 MTE with re-inforced bushing, exhaust not-cooled
engine 4304585019
engine 4304590012
engine 4304614046
10 cyl. dia. 125

D2530 MTE with re-inforced bushing, exhaust
water-cooled
engine 4304585019
engine 4304590012
engine 4304614046
from engine 4304759011
10 cyl. dia. 125

D2530 ME with re-inforced bushing, exhaust
water-cooled 10 cyl. dia. 125

D2538 M/MF 189kW, 8 cyl. dia. 125
from 1972, 8 pcs required

D2538 ME with re-inforced bushing,
from engine 465507, 8 cyl. Dia 125

D2538 ME/MTE oil filter reversible
exhaust not-cooled, 8 cyl. dia. 125

D2538 MT, 237kW, 8 cyl. dia. 125
From 1973

D2538 MTE with re-inforced bushing,
from engine 4655076, 8 cyl. dia. 125

D2540 MLE with re-inforced bushing, exhaust water-
cooled from engine 4534610068
10 cyl. dia. 125

D2540 MTE with re-inforced bushing,
engine 4514598038
engine 4514598039
engine 4514598040
from engine 4514615058
10 cyl. dia. 125

D2540 MTF/MTH with re-inforced bushing, from engine
4584607064, 10 cyl. dia. 125

D2530MXF/MXFR with re-inforced bushing, exhaust not-
cooled, 10 cyl 125 dia

D2566 MUH from engine 3294091103

D2566 MUM from engine 3394097095
6 cyl. dia. 125

D2542 MT/ME with re-inforced bushing,
12 cyl. dia. 125

D2542 ME oil filter reversible, exhaust not cooled,
12 cyl. dia. 125

D2542 ME with re-inforced bushing, exhaust not-cooled,
from engine 4704650001
12 cyl. dia. 125

D2542 MLE exhaust not-cooled, without air-compressor,
from engine 4904675003
12 cyl. dia. 125

D2542 MLE with re-inforced bushing, exhaust water-cooled
from engine 4904675003
12 cyl. dia. 125

D2542 MLE 12 cyl. dia. 125

D2542 MTE with re-inforced bushing, exhaust water-cooled,
from engine 48046540006 12 cyl. dia. 125

D2542 MTE oil filter not reversible, exhaust not cooled
12 dia 125

D2555 M/MF/MX/MXF
5 cyl. dia. 125

D2555 MXE without air-compressor exhaust not-cooled,
fuel filter not reversible
5 cyl. dia. 125

D2555 MXUH/MXUL

D2565 MXUH/MXUL

up to engine 4135000, 5 cyl. dia. 125
D2565 M/MF/MFR/MH/MHO/MR
5 cyl. dia. 125

D2565 ME without air-compressor
exhaust not-cooled 5 cyl. dia. 125

D2556 MXUH/MXUM up to engine 4091102

D2566 MUM from engine 4095094

D2566 UH/UH-200/UM
6cyl. dia. 125

D2566 M/MR/MF/MFR up to engine 4091059
D2566MFG up to engine 4092000
D2566 MFO/FMOR up to engine 4093057
D2566 MH/MHO up to engine 4092102
6 cyl. dia. 125

Manifold gasket – EXHAUST

dph-no.	OEM-no.	application
		D2566 M/MR/MF/MFR/MFO/MFOR from engine 4099001 6 cyl. dia. 125
		D2566ME from engine 4094086
		D2566 MTE from engine 4069119 6 cyl. dia. 125
		D2566 MFG from engine 4092001 6 cyl. dia. 125
		D2566 MK/MKF/MKH/MK-Sibmas 1 cyl air-compressor 6 cyl. dia. 125
		D2566 MLE exhaust not-cooled 6 cyl. dia. 125
		D2566 MLUM USA/Canada 6 cyl. dia. 125
		D2566 MT/MTF/MTH/MTHO/MTFG 6 cyl. dia. 125
		D2566 MTUE/MTUH/MTUM USA 6 cyl. dia. 125
		D2840 LE/LF 338kW/LF01/04/06/20/21/LXE/ME exhaust water cooled
		D2840 MF/MFR/MH 10 cyl. dia. 128
		D2842 LXE/LYE/LYZ/LEE + D2842 ME exhaust water cooled 12 cyl. dia. 128
		D2848 LE/LXE/M 8 cyl. dia. 128
		D2865 LF/LFR/LXF/LXFR/LF01../LF21-24, LFR01.. LOH01/02/05/07-09 5 cyl. dia. 128
		D2865 LU 01-03 5 cyl. dia. 128
		D2865 LUH02/03/05-09 5 cyl. dia. 128
		D2866 F/FR, DOH01/DF01
		D2866 FZR/FG/OH
		D2866 KF/KFZ/KH/KOH, LOH02/03/06/07, LXOH, LF02-10/14-16, LFZ/LFZR, LH01-02/LXF
		D2866 LF20/21/22, LF29/30
		D2866 LE/TE 6 cyl. dia. 128
		D2866 UH/UM/TUH/TUM/KUH/KUL/LXU/LU/LUL/LUH 6 cyl. dia. 128
		D2866 LUH20/21/22/26 6 cyl. dia. 128
		D2876 LF01/LF02/LOH01 6 cyl. dia. 128
		E2542 E exhaust not-cooled oil filter reversible 12 cyl. dia. 125

Manifold gasket – INTAKE

dph-no.	OEM-no.	application
109876	51 08902 0179	D0824 4 cyl. dia.. 108, 4 pcs required D0824 GF 75kW, 4 cyl. 108 dia from 1987 4 pcs. required
83878	51 08902 0161	 D2530 ME , oil filter reversible, exhaust not cooled 10 cyl. dia. 125 10 pcs required D2530 ME with re-inforced bushing, exhaust not-cooled, 10 cyl. dia. 125 10 pcs required D2540 MTF/MTH up to engine 4584607063 10 cyl. dia. 125 10 pcs required D2542 E with re-inforced bushing, from engine 4702001, 12 cyl. dia. 125 12 pcs required D2530 MF/MXH/MXF/MXFR 235 kW, 10 cyl. dia. 125 from 1971, 10 pcs required D2530 MTE with re-inforced bushing, exhaust not-cooled engine 4304585019 engine 4304590012 engine 4304614046 10 cyl. dia. 125
		D0826 6 cyl. dia. 108 6 pcs required D0826 6 cyl. dia. 108 with crank-case cover, 6 pcs required
		D0836 LFL01 6 cyl. dia. 108 6 pcs required
		D2530 MTE with re-inforced bushing, exhaust water cooled engine 4304585019 engine 4304590012 engine 4304614046 from engine 4304759011 10 cyl. dia. 125 D2530 ME with re-inforced bushing, exhaust water cooled 10 cyl. dia. 125
		D2538 ME with re-inforced bushing, from engine 465507, 8 cyl. Dia 125 D2538 ME/MTE oil filter reversible exhaust not-cooled, 8 cyl. dia. 125 D2538 MT , 237kW, 8 cyl. dia. 125 from 1973 D2538 MTE with re-inforced bushing, from engine 4655076, 8 cyl. dia. 125
		D2540 MLE with re-inforced bushing, exhaust water-cooled, from engine 4534610068, 10 cyl. dia. 125 D2540 MTE with re-inforced bushing, engine 4514598038 engine 4514598039 engine 4514598040 from engine 4514615058 10 cyl. dia. 125 D2540 MTF/MTH with re-inforced bushing, from engine 4584607064, 10 cyl. dia. 125
		D2530 MXF/MXFR with re-inforced bushing, exhaust not-cooled, 10 cyl 125 dia

Manifold gasket – INTAKE

dph-no.	OEM-no.	application
		<p>D2566 MUH from engine 3294091103 D2566 MUM from engine 3394097095 6 cyl. dia. 125</p> <p>D2542 MT/ME with re-inforced bushing, 12 cyl. dia. 125 D2542 ME oil filter reversbile, exhaust not cooled, 12 cyl. dia. 125 D2542 ME with re-inforced bushing, exhaust water-cooled, from engine 4704650001 12 cyl. dia. 125 D2542 MLE exhaust not-cooled, without air-compressor, from engine 4904675003 12 cyl. dia. 125 D2542 MLE with re-inforced bushing, exhaust water-cooled from engine 4904675003 12 cyl. dia. 125 D2542 MLE 12 cyl. dia. 125 dia D2542 MTE with re-inforced bushing, exhaust water-cooled, from engine 48046540006 12 cyl. dia. 125 D2542 MTE oil filter reversible exhaust not cooled 12 cyl. dia. 125</p> <p>D2555 M/MF/MX/MXF 5 cyl. dia. 125 D2555 MXE without air-compressor, exhaust not-cooled, fuel filter not reversbile 5 cyl. dia. 125 D2555 MXUH/MXUL D2565 MXUH/MXUL up to engine 4135000, 5 cyl. dia. 125 D2565 M/MF/MFR/MH/MHO/MR 5 cyl. dia. 125 D2565 ME without air-compressor, exhaust not-cooled 5 cyl. dia. 125 D2556 MXUH/MXUM up to engine 4091102 D2566 MUM from engine 4095094 D2566 UH/UH-200/UM 6cyl. dia. 125 D2566 M/MR/MF/MFR up to engine 4091059 D2566 MFG up to engine 4092000 D2566 MFO/FMOR up to engine 4093057 D2566 MH/MHO up to engine 4092102 6 cyl. dia. 125</p> <p>D2566 M/MR/MF/MFR/MFO/MFOR from engine 4099001 6 cyl. dia. 125 D2566 ME from engine 4094086 D25566 MTE from engine 4069119 6 cyl. dia. 125</p> <p>D2566 MFG from engine 4092001 6 cyl. dia. 125</p>
		<p>D2566 MK/MKF/MKH/MK-Sibmas 1 cyl. air-compressor 6 cyl. dia. 125 D2566 MLE exhaust not-cooled 6 cyl. dia. 125</p> <p>D2566 MLUM USA/Canada 6 cyl. dia. 125 D2566 MT/MTF/MTH/MTHO/MTFG 6 cyl. dia. 125 D2566 MTUE/MTUH/MTUM USA 6 cyl. dia. 125</p> <p>D2840 LE/LF 338kW/LF01/04/06/20/21/LXE/ME exhaust water-cooled D2840 MF/MFR/MH 10 cyl. dia. 128</p> <p>D2842 LXE/LYE/LYZ/LEE + D2842 ME exhaust water-cooled 12 cyl. dia. 128</p> <p>D2848 LE/LXE/M 8 cyl. dia. 128</p> <p>D2865 LF/LFR/LXF/LXFR/LF01../LF21-24, LFR01.. LOH01/02/05/07-09 5 cyl. dia. 128 D2865 LU 01-03 5 cyl. dia. 128 D2865 LUH02/03/05-09 5 cyl. dia. 128</p> <p>D2866 F/FR, DOH01/DF01 D2866 FZR/FG/OH D2866 KF/KFZ/KH/KOH, LOH02/03/06/07, LXOH, LF02-10/14-16, LFZ/LFZR, LH01-02/LXF D2866 LF20/21/22, LF29/30 D2866 LE/TE 6 cyl. dia. 128 D2866 UH/UM/TUH/TUM, KUH/KUL/LXU/LU/LUL/LUH 6 cyl. dia. 128 D2876 LF01/LF02/LOH01 6 cyl. dia. 128</p> <p>E2542 E with re-inforced bushing, exhaust water-cooled, from engine 4702001 12 cyl. dia. 125</p> <p>E2542 E exhaust water-cooled, oil filter not reversible 12 cyl. dia. 125</p>
97114	51 08902 0121	
61054 96870	51 08902 0115 51 08902 0135	

● Oil seal – engine housing

dph-no.	OEM-no.	application	
46636	06 56279 0073		Size: 72 x 105 x 13 NBR CS blue
69160	06 56279 0312		Size: 72 x 105 x 13 NBR BS green
35614	81 96501 0477	Size: 11 x 17 x 4 NBR A	
35109	06 56279 0019	Size: 70 x 90 x 13 NBR C	

Engine parts, fuel, exhaust and cooling system parts

Oil seal – various



dph-no.	OEM-no.	application
35085	0024 411 524	Size: 80 x 100 x 10 NBR A
35086	0024 411 800	
35087	0024 411 971	Size: 120 x 150 x 13 NBR A
35088	0024 411 973	Size: 150 x 180 x 13 NBR A
35089	06 56261 1207	Size: 18 x 30 x 7 NBR B
35091	06 56269 0001	Size: 10 x 19 x 7 NBR B
82925	06 56271 0404	Size: 40 x 55 x 7 NBR B
82926	06 56271 0406	Size: 40 x 62 x 7 NBR B
82860	06 56271 1613	Size: 65 x 85 x 10 NBR B
82927	06 56271 1616	Size: 65 x 100 x 10 NBR B
35093	06 56271 2015	Size: 75 x 95 x 10 NBR B
84398	06 56271 3814	Size: 70 x 90x 10 NBR B

Oil seal – various

dph-no.	OEM-no.	application
35096	06 56272 1212	Size: 58 x 80x 10 NBR C
35098	06 56272 1313	Size: 60 x 85x x13 NBR C
35099	06 56272 1613	Size: 65 x 85x 12 NBR C
35100	06 56272 1614	Size: 65 x 90 x 12 NBR C
35101	06 56272 1714	Size: 68 x 90x 12 NBR C
35102	06 56272 1814	Size: 70 x 90x 12 NBR C
35103	06 56272 1816	Size: 70 x 100 x 13 NBR C
35108	06 56279 0014	Size: 42 x 65x 10 NBR C
35118	06 56279 0054	Size: 60 x 80 x 13 NBR B
35119	06 56279 0055	Size: 60 x 80 x 10 NBR BS
35123	06 56279 0059	Size: 62 x 85x 10 NBR C
35126	06 56279 0066	Size: 70 x 95 x 13 NBR C
104429	06 56279 0235	Size: 60 x 80 x 10 NBR CS
94804	06 56279 0262	Size: 42 x 52 x 7, 5/8 FPM A/BS RD W
61341	06 56279 0273	Size: 50 x 58 x 4 NBR BO
95831	06 56279 0284	Size: 37,5 x 45 x 4 NBR BO
95832	06 56279 0289	Size: 42 x 49 x 4 NBR BO
81191	06 56279 0297	Size: 42 x 55 x 9 FPM B
84546	06 56279 0310	Size: 42 x 58 x 7 NBR B
93350	06 56279 0323	Size: 68 x 90 x 10/9,5 FPM B WD
61407	06 56279 0327	Size: 68 x 90 x 10 A NBR blue
69845	06 56279 0335	Size: 75 x 95 x 10 NBR A blue

Oil seal – various

dph-no.	OEM-no.	application
81590	06 56279 0350	Size: 42 x 58 x 7 NBR BS
35128	06 56282 0906	Size: 115 x 140 x 15 NBR C
35130	06 56282 2015	Size: 190 x 220 x 15 NBR C blue
35145	06 56289 0031	Size: 80 x 105 x 15 NBR B green
35154	06 56289 0046	Size: 190 x 220 x 15 NBR C
35156 34819	06 56289 0063 06 56289 0065	Size: 145 x 175 x 13 NBR A/B W blue
110697	06 56289 0207	Size: 100 x 120 x 13/10 NBR C blue
51884	06 56289 0181	Size: 85 x 105 x 12 NBR green C
93450	06 56289 0241	Size: 110 x 140 x 13 NBR CS
96261	06 56289 0248	Size: 145 x 175 x 14/12 FPM A WD
81610	06 56289 0315	Size: 110 x 130 x 12 NBR A
80856	06 56289 0321	Size: 90 x 110 x 10 NBR A
82967	06 56289 0322	Size: 95 x 115 x 10/9,5 A/B NBR blue
37845	06 56289 0324	Size: 100 x 130 x 12 NBR A
80358	06 56289 0349	Size: 80 x 100 x 12 FPM A/B WB
61486	06 56289 0353	Size: 80 x 100 x 12 NBR BS blue
83892	06 56289 0366	Size: 160 x 180 x 10/11 NBR BS blue
109684	06 56289 0369	Size: 100 x 130 x 12 FPM A/B
81568	06 56289 0385	Size: 130 x 160 x 16 FPM A/BS WD
111280	06 56289 0387	Size: 132 x 160 x 10 FPM B WD
93880	81 96502 0356	Size: 26 x 37 x 7 AS NBR
93474	06 56289 0386	Size: 145 x 175 x 16 FPM AW/BS WD

● O-ring – engine/variou

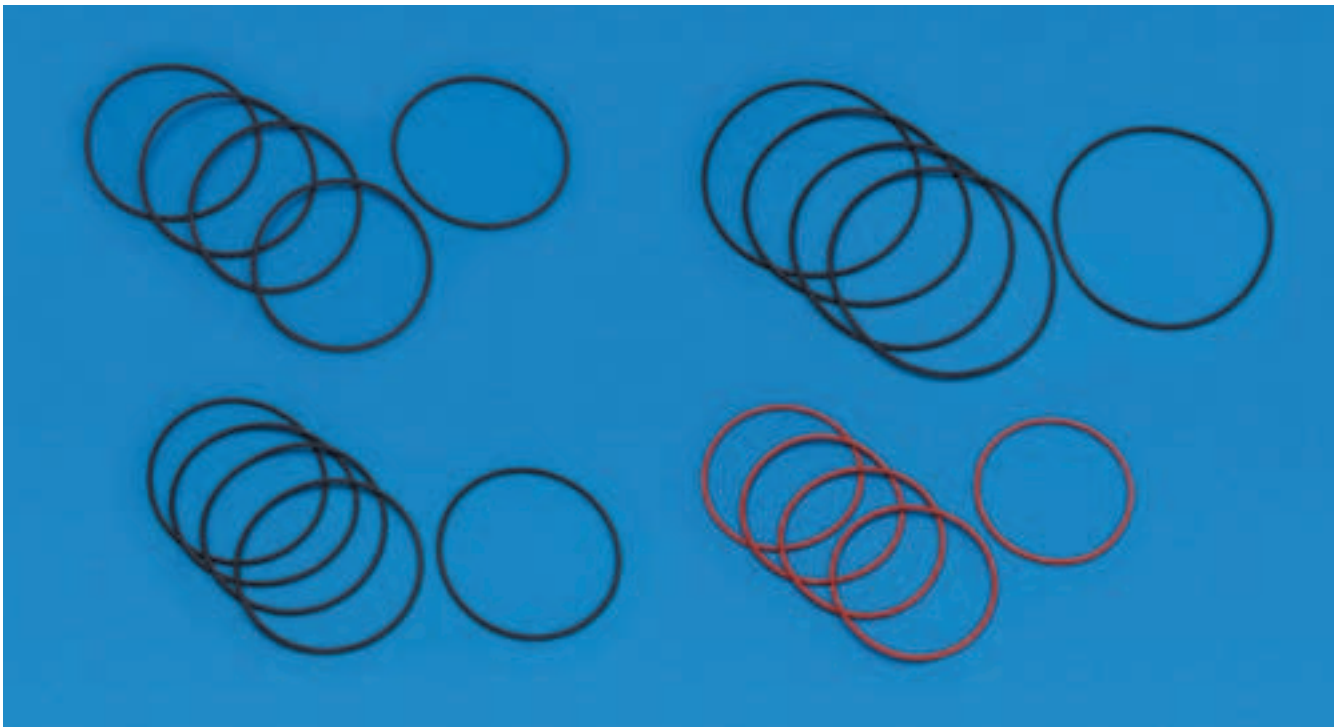

dph-no.	OEM-no.	application
82112	06 56939 0031	Size: 12 x 1,5 NBR 70
94225	06 56939 0033	Size: 6,07 x 1,78 EPDM 70
109767	06 56939 0053	Size: 7,5 x 2 NBR 70
109769	06 56939 0054	Size: 12 x 2 NBR 70
69150	50 96501 0354	Size: 168 x 4 FPM 80
111091	50 96501 0433	Size: 186 x 3,5 NBR 70
111090	50 96501 0434	Size: 172 x 4 NBR 70
98100	51 06901 0027	Size: 8 x 4 NBR 80
68991	51 96501 0007	Size: 67 x 4 NBR 70
84406	51 96501 0023	Size: 24,99 x 3,53 NBR 70
33151	51 96501 0035	Size: 60 x 4 NBR 70
6680	51 96501 0092	Size: 88 x 5 NBR 70
36615	51 96501 0146	Size: 75,8 x 3,53 NBR 70
6679	51 96501 0151	Size: 22 x 3 NBR 70

O-ring – engine/variou

dph-no.	OEM-no.	application
6681	51 96501 0166	Size: 20 x 2 NBR 70
33317	51 96501 0184	Size: 52 x 3 NBR 70
32760	51 96501 0203	Size: 72 x 4 NBR 70
6682	51 96501 0234	Size: 22 x 4 FPM 75 green
32571	51 96501 0260	Size: 78 x 3 NBR 70
37302	51 96501 0262	Size: 92 x 3 NBR 70
82759	51 96501 0305	Size: 36 x 3,2 NBR 70
110895	51 96501 0326	Size: 16 x 3,5 NBR 60
33152	51 96501 0347	Size: 108 x 4 NBR 70
6686	51 96501 0355	Size: 144 x 4 NBR 70
33149	51 96501 0361	Size: 96 x 4,3 NBR 70
34822	51 96501 0372	Size: 69,5 x 3 NBR 70
94865	51 96501 0414	Size: 26 x 3,5 FPM 75 green
34577	51 96501 0422	Size: 129,54 x 5,33 FPM 80
32761	51 96501 0429	Size: 72 x 4 FPM green 80
110933	51 96501 0464	Size: 23 x 3 NBR 70
94535	51 96501 0487	Size: 130 x 4 NBR 70
110819	51 96501 0489	Size: 7 x 1,5 FPM 80
110838	81 96503 0252	Size: 10,5 x 5 green 75
110881	81 96503 0253	Size: 14 x 2 Therban green 70
110898	81 96503 0254	Size: 17 x 2 FPM 75 green
111031	81 96503 0266	Size: 82,28 x 1,78 FPM 80

O-ring – engine/variou

dph-no.	OEM-no.	application
110937	81 96503 0267	Size: 24,5 x 3 FPM 80
111007	81 96503 0268	Size: 34,5 x 3 FPM 80
111049	81 96503 0269	Size: 118 x 2,5 FPM 80
110853	81 96503 0272	Size: 11,6 x 2,4 FPM 80
111086	81 96503 0274	Size: 151,99 x 3,53 FPM 80
110926	81 96503 0275	Size: 20,29 x 2,62 FPM 80
111064	81 96503 0276	Size: 60,04 x 1,78 FPM 80
110995	81 96503 0279	Size: 29,82 x 2,62 FPM 70
110934	81 96503 0286	Size: 23,4 x 3,53 FPM 80
110986	81 96503 0297	Size: 26,7 x 1,78 FPM 80
111043	81 96503 0307	Size: 107,54 x 3,53 EPDM 70
110981	81 96503 0325	Size: 25,07 x 2,62 FPM 80
110840	81 96503 0359	Size: 10,82 x 1,78 FPM 80
110857	81 96503 0360	Size: 13,47 x 2,08 FPM 80
111058	81 96503 0370	Size: 55 x 3 FPM 80
110843	81 96503 0376	Size: 11,1 x 1,6 FPM 80
110841	81 96503 0396	Size: 10,82 x 1,78 Therban 70 green
110834	81 96503 0400	Size: 9,5 x 2,5 NBR 80
111054	81 96503 0406	Size: 39 x 3 FPM 75 green
110982	81 96503 0409	Size: 26 x 3 FPM 75 green
110993	81 96503 0410	Size: 29 x 3 FPM 75 green
111056	81 96503 0411	Size: 52 x 3 FPM 75 green

O-ring – engine/variou

dph-no.	OEM-no.	application
111048	81 96503 0412	Size: 117,1 x 1,78 NBR 70
111071	81 96503 0422	Size: 73 x 2,5 FPM 75 green
110918	81 96503 0425	Size: 19.18 x 2,46 NBR 70
111051	81 96503 0428	Size: 120 x 2,5 NBR 80
111053	81 96503 0438	Size: 49,5 x 3 NBR 90
111072	81 96503 0439	Size: 74,5 x 4 NBR 90
111057	82 00001 2815	Size: 52 x 3 NBR 70
111094	84 96503 0050	Size: 245 x 3 FPM 80
110980	85 30001 1953	Size: 25 x 4 NBR 70
111075	85 30001 8611	Size: 78 x 3 NBR 70
111046	85 30001 9771	Size: 114,5 x 3 FPM 80
111055	85 30002 0091	Size: 47,2 x 5,7 FPM 75 green
110935	85 50001 1181	Size: 24 x 5 NBR 70
111087	85 50001 4583	Size: 154,2 x 5,7 NBR 70
111089	85 50001 4585	Size: 160 x 3 NBR 70
111003	85 50001 4657	Size: 33 x 5 NBR 70
110890	85 50001 4669	Size: 15 x 3 NBR 70
33320	88 01901 0247	Size: 140 x 5 NBR 70
33319	88 01902 0001	Size: 100 x 3 NBR 70
34342	88 96501 0014	Size: 125 x 5 NBR 70
33318	88 96501 0219	Size: 138 x 5 NBR 70
32283 33148	88 96501 0244 90 80119 5428	Size: 126 x 5 NBR 70

● O-ring – engine/variou

dph-no.	OEM-no.	application
111011	90 91148 7007	Size: 36 x 3 NBR 70
97683	K0 00117 4733	Size: 8 x 3 MVQ 50 red
111076	K0 00116 4294	Size: 120 x 4 MVQ red-brown
110922	K0 00116 6024	Size: 20 x 3 MVQ 50 red
110924	K0 00117 0540	Size: 20 x 4 MVQ 50 red
111070	K0 00117 0551	Size: 72 x 4 MVQ 50 red
110827	K0 00117 3438	Size: 8 x 2 MVQ 50 blue
110831	K0 00117 4733	Size: 8 x 3 MVQ 70
110856	K0 00130 6571	Size: 13 x 1,5 FPM 70

● Washer – engine

dph-no.	OEM-no.	application
34339	06 56190 0713	<div data-bbox="424 1043 911 1292" data-label="Image"> </div> <p>Size: 18 x 24 x 1,5 CU</p> <p>D0224 MF, 66kW, 4 cyl. 102 dia. from 1980</p> <p>D0226 M/MF/MFA 100kW, 6 cyl. dia. 102 from 1980</p> <p>D0226 MKF/MC/MCFO 125/141 kW 6 cyl. dia 102 from 1984</p>

● Sealing washer, copper/various



dph-no.	OEM-no.	application
34882	05 56190 0706	Size: 14 x 20 x 105
81101	06 56180 0704	Size: 5 x 9 x 1
80897	06 56180 0708	Size: 6,5 x 11 x 1
34953	06 56180 0709	Size: 8 x 11,5 x1
94224	06 56180 0713	Size: 10 x 13,5 x 1
51457	06 56190 0704	Size: 12 x 18 x 1,5
34812	06 56190 0705	Size: 14 x 18 x 1,5
4460	06 56190 0706	Size: 14 x 20 x 1,5
36176	06 56190 0708	Size: 16 x 20 x 1,5
21232	06 56190 0709	Size: 16 x 22 x 1,5
93160	06 56190 0712	Size: 18 x 22 x 1,5
82992	06 56190 0715	Size: 20 x 26 x 1,5
98714	06 56190 0716	Size: 21 x 26 x 1,5
36177	06 56190 0718	Size: 22 x 27 x 1,5

● Sealing washer, copper/variou

dph-no.	OEM-no.	application
94713	06 56190 0719	Size: 22 x 29 x 1,5
81518	06 56190 0722	Size: 24 x 29 x 2
36837	06 56190 0726	Size: 26 x 31 x 2
35243	06 56190 0727	Size: 26 x 34 x 2
51218	06 56190 0732	Size: 30 x 36 x 2
84506	06 56190 0734	Size: 32 x 38 x 2
94785	06 56190 0739	Size: 36 x 42 x 2
109079	06 56180 0712	Size: 8 x 14 x 1
34789	06 56180 0716	Size: 10 x 16 x 1
61403	81 11904 0044	Size: 16 x 20 x 1
98099	06 56192 0732	Size: 30 x 36 x 2

● Sealing washer, aluminium/variou

dph-no.	OEM-no.	application
35006	06 56190 0822	Size: 24 x 29 x 2
37553	06 56200 0811	Size: 45 x 52 x 2



O-ring/seal ring – engine/fuel-/oil filter

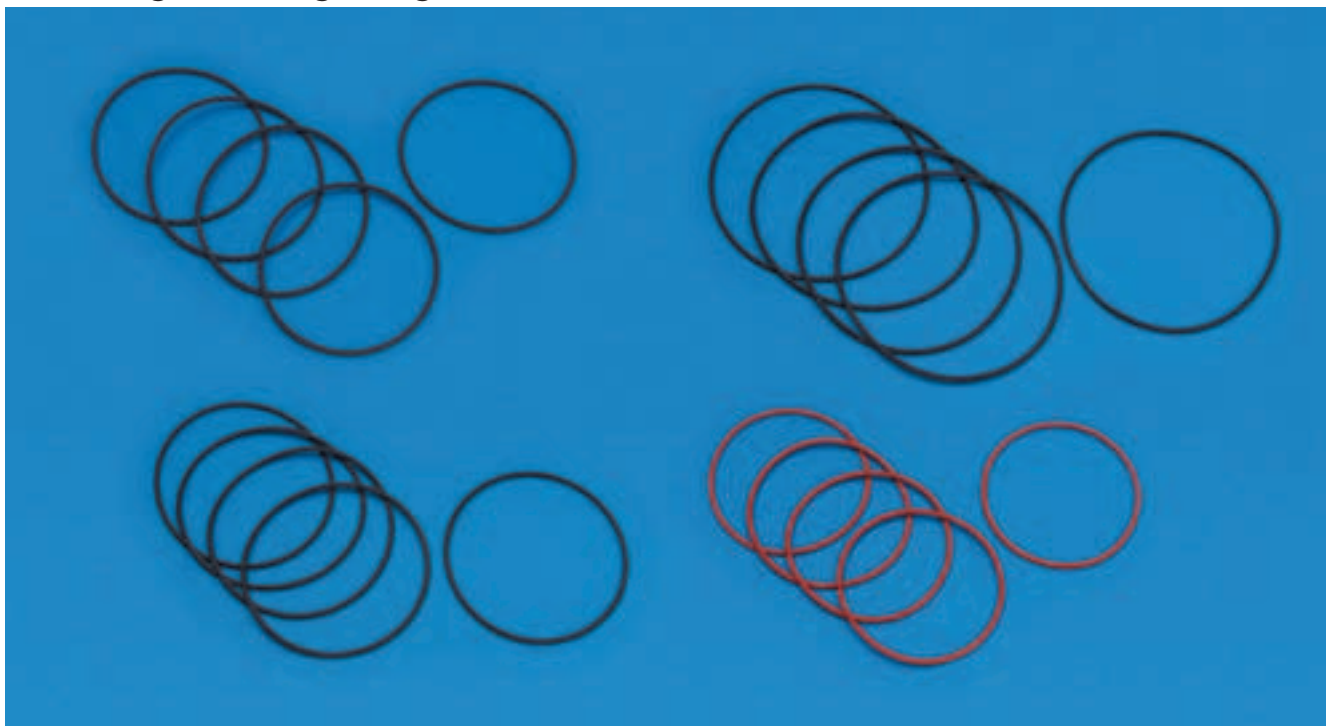

dph-no.	OEM-no.	application
4570	51 96501 0417	Size: 138 x 2,10 FPM 75 D2866 UH/UM/TUH/TUM/KUH/KUL/LXU/LU/LUL/LUH 6 cyl. dia. 128 12 pcs required, top
6688	51 96501 0412	Size: 144 x 4 FPM 75 green D2866 UH/UM/TUH/TUM/KUH/KUL/LXU/LU/LUL/LUH 6 cyl. dia. 128 12 pcs required, bottom
33310	06 56331 1165	Size: 30,3 x 2,4 NBR 70 Engine
110984	06 56331 1259	Size: 26 x 3 NBR 70 Fuel
93491	06 56331 2164	Size: 30 x 2,5 NBR 70 Engine
33146	51 96501 0265	Size: 134 x 4 NBR 70 Oil filter
93465	51 96501 0286	Size: 86 x 3 NBR 70 Engine
37296	51 96501 0288	Size: 138 x 3,5 NBR 70 Engine
4600	51 96501 0322	Size: 7 x 3 FPM 70 Engine
33366	51 96501 0324	Size: 126 x 3 FPM 80 Engine
6684	51 96501 0337	Size: 36,10 x 3,53 NBR 70 Engine
6473	51 96501 0342	Size: 120,25 x 3,53 NBR 70 Engine
6689	51 96501 0413	Size: 28 x 8 NBR 70 Engine

● O-ring/seal ring – engine/fuel-/oil filter

dph-no.	OEM-no.	application
6809	51 96501 0415	Size: 78 x 3 FPM 75 green Engine, oil pressure
33150	06 56331 3264	Size: 30 x 4 NBR 70 Engine
48734	06 56331 3269	Size: 34 x 3 NBR 70 Engine
6474	06 56331 4242	Size: 18 x 3 NBR 70 Engine
6669	06 56341 1122	Size: 60 x 3 NBR 70 Engine
69857	06 56341 1209	Size: 49 x 3 NBR 70 Engine
93502	06 56341 1213	Size: 52 x 3 NBR 70 Engine
6671 69858	06 56341 2122 51 96501 0261	Size: 60 x 4 NBR 70 Thermostat
68516 6683	06 56930 0632 51 96501 0327	Size: 11,91 x 2,62 NBR 70 Engine
81158	06 56930 2107	Size: 46 x 3 NBR 70 Engine
82486	06 56930 3036	Size: 88 x 5 NBR 70 Engine
36263 6524	06 56930 3809 51 96501 0393	Size: 133 x 4,4 NBR 70 Engine/oil filter
93475	06 56930 4388	Size: 185 x 5 NBR 70 Engine
93833	11202 0037	Size: 95 x 103 x 3 NBR 80 Gasoline filter ring

O-ring/engine - various

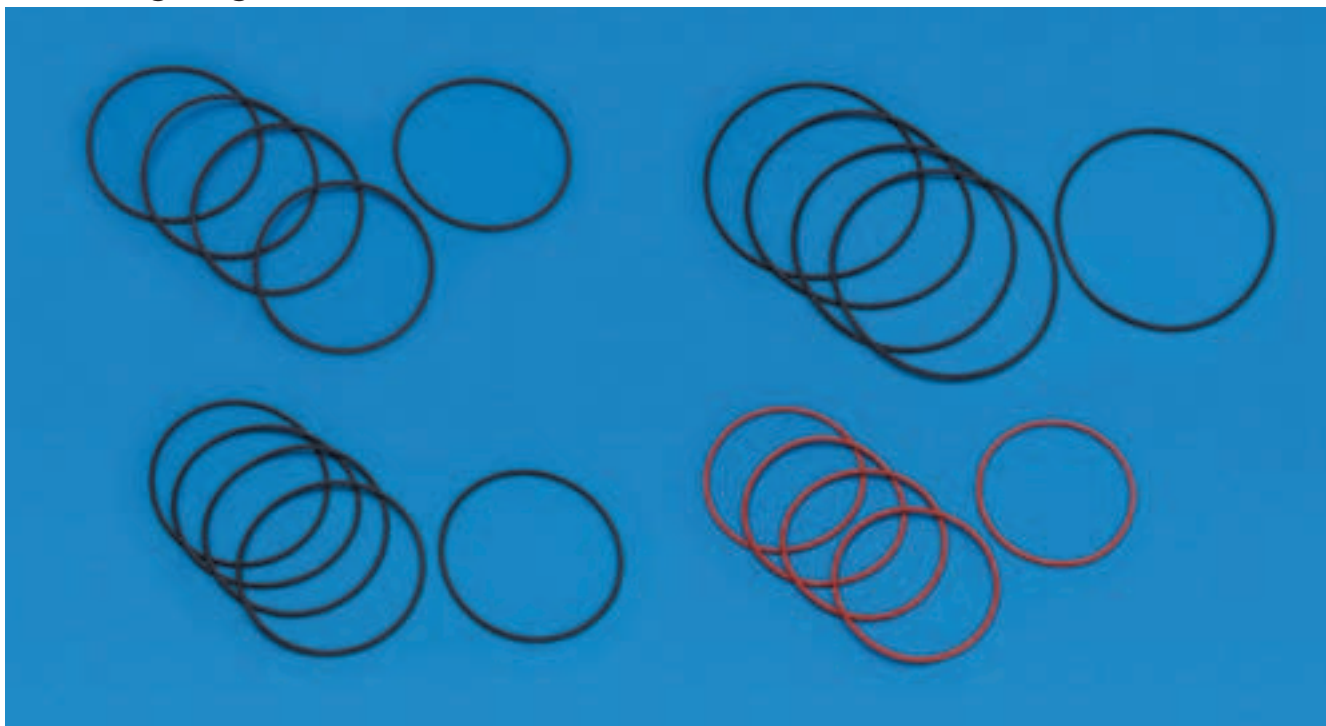

dph-no.	OEM-no.	application
6634	81 96501 0407	Size: 74,5 x 3 NBR 70
33600	81 96501 0412	Size: 142 x 5 NBR 70
95833	06 56279 0353	Size: 50 x 4 NBR 70
69856	06 56311 0139	Size: 16 x 3 NBR 70
33778	06 56331 0215	Size: 12,5 x 2,5 NBR 70
33305	06 56331 0216	Size: 14 x 2,5 NBR 70
33306	06 56331 0219	Size: 15 x 2,5 NBR 70
50873	06 56331 0220	Size: 16 x 2,5 NBR 70
98101	06 56331 0225	Size: 9 x 1,5 NBR 70
6665	06 56331 0226	Size: 9 x 2 NBR 70
6666	06 56331 0238	Size: 15 x 2 NBR 70
33307	06 56331 0252	Size: 23 x 2 NBR 70
35139	06 56331 0257	Size: 25,3 x 2,4 NBR 70
6667	06 56331 0263	Size: 29 x 3 NBR 70

O-ring/engine – various

dph-no.	OEM-no.	application
82933	06 56331 0264	Size: 30 x 2 NBR 70
33308	06 56331 0270	Size: 33,3 x 2,4 NBR 70
4110	06 56331 0334	Size: 12 x 2 NBR 70
33309	06 56331 1116	Size: 14 x 3 NBR 70
6668	06 56331 1209	Size: 6 x 2 NBR 70
50503	06 56331 1219	Size: 15,5 x 2,25 NBR 70
80469	06 56331 1227	Size: 9,5 x 2,5 NBR 70
82107	06 56331 1234	Size: 13 x 2 NBR 70
6635	06 56331 1248	Size: 20,3 x 2,4 NBR 70
82351	06 56331 1256	Size: 24 x 2 NBR 70
33311	06 56331 1280	Size: 40 x 2,5 NBR 70
98098	06 56331 2219	Size: 16 x 2 NBR 70
35941	06 56331 2222	Size: 12 x 1,5 NBR 70
37565	06 56331 2232	Size: 11,5 x 3 NBR 70
82108	06 56331 2241	Size: 18 x 2 NBR 70
80685	06 56331 2244	Size: 18,77 x 1,78 NBR 70
33714	06 56331 2245	Size: 19 x 2,5 NBR 70
94712	06 56331 3205	Size: 4 x 1,5 NBR 70
35940	06 56331 3222	Size: 14 x 1,5 NBR 70
6475	06 56331 3257	Size: 24,99 x 3,53 NBR 70
61437	06 56331 3274	Size: 36 x 5 NBR 70
4032	06 56331 3332	Size: 11 x 4 NBR 70

O-ring/engine – various

dph-no.	OEM-no.	application
37284	06 56331 3406	Size: 5 x 1,5 NBR 90
97139	06 56331 3423	Size: 14 x 2 NBR 90
33312	06 56331 4158	Size: 25 x 5 NBR 70
36399 34264	06 56331 4200 06 56331 4210	Size: 7 x 1,5 NBR 70
81694	06 56331 4207	Size: 5,3 x 2,4 NBR 70
34265	06 56331 4212	Size: 11 x 1,5 NBR 70
82279	06 56331 4217	Size: 17,3 x 2,4 NBR 70
33373	06 56331 4222	Size: 15,1 x 1,6 NBR 70
110919	06 56331 4244	Size: 19 x 3 NBR 70
36261	06 56331 4266	Size: 31,2 x 3 NBR 70
22976 22975	06 56331 4269 06 56331 4270	Size: 35,2 x 3 NBR 70
24960	06 56331 4271	Size: 34 x 2,3 NBR 70
94442	06 56332 0265	Size: 30 x 3 NBR 70
80498	06 56332 2167	Size: 32 x 2,5 NBR 70
6637	06 56332 4254	Size: 255 x 5 ACM 70
81047	06 56332 4280	Size: 40 x 3 FPM 80
33154	06 56333 0240	Size: 17 x 2 FPM 75 green
33313	06 56333 0334	Size: 12 x 2 FPM 75 green
4575	06 56333 1169	Size: 30 x 4,5 FPM 75 green
93420	06 56333 1211	Size: 8 x 2 FPM green
81607	06 56333 1242	Size :18 x ,5 FPM 80
110891	06 56333 2316	Size: 15,54 x 2,62 FPM 80

O-ring/engine – various

dph-no.	OEM-no.	application
33155	06 56333 2363	Size: 28 x 2,5 FPM green 75
33315	06 56333 3180	Size: 40 x 4 FPM 75 green
81048 97102	06 56333 3206 06 56333 3306	Size: 5 x 1,5 FPM 80
110923	06 56333 3248	Size: 20 x 3,5 FPM 80
32660	06 56333 3256	Size: 24 x 3 FPM 75 green
32880	06 56333 3276	Size: 36 x 3 FPM 75 green
80589	06 56333 3280	Size: 40 x 4 FPM 70
84385	06 56333 3363	Size: 28 x 3 FPM 75 green
34788	06 56333 4245	Size: 19,2 x 3 FPM 75 green
111015	06 56333 4274	Size: 37,69 x 3,53 FPM 70
84386	06 56333 4277	Size: 37 x 3 FPM green
51469	06 56333 4314	Size: 12 x 2,5 NBR 70
93832	06 56341 0209	Size: 48 x 3 NBR 70
36762	06 56341 0223	Size: 62 x2 NBR 70
33846	06 56341 0234	Size: 87 x 3 NBR 70
111077	06 56341 0251	Size: 120,25 x 3,53 NBR 70
81576	06 56341 1118	Size: 56 x 3 NBR 70
68275	06 56341 1201	Size: 40 x 3 NBR 70
6670	06 56341 1236	Size: 90 x 4 NBR 70
33978	06 56341 1239	Size: 101 x 4 NBR 70
32082	06 56341 1257	Size: 140 x 4 NBR 70
61436	06 56341 1260	Size: 150 x 4,5 NBR 70

O-ring/engine – various

dph-no.	OEM-no.	application
33709	06 56341 2129	Size: 72 x 5,5 NBR 70
82928	06 56341 3205	Size: 45 x 5 NBR 70
33316	06 56341 3219	Size: 59 x 3 NBR 70
36262	06 56341 3237	Size: 96 x 3 NBR 70
82929	06 56341 3245	Size: 109,2 x 5,7 NBR 70
51559	06 56341 3258	Size: 144 x 4 NBR 70
51560	06 56341 3259	Size: 160 x 4 NBR 70
6672	06 56341 3271	Size: 269 x 6 NBR 70
6673	06 56341 3350	Size: 120 x 4 NBR 70
95606	06 56341 4135	Size: 98 x 3 NBR 70
32537	06 56341 4210	Size: 76 x 2,5 NBR 70
70802	06 56341 4259	Size: 177,4 x 3,53 NBR 70
6675	06 56342 0206	Size: 47,29 x 2,62 NBR 70
35942	06 56342 0331	Size: 80 x 3 FPM 80
93421	06 56342 4241	Size: 94,5 x 3 NBR 70
34844	06 56343 1238	Size: 80 x 3 FPM 75 green
93557	06 56343 3236	Size: 82 x 3 FPM 80
94687	06 56343 3242	Size: 64 x 4 FPM green 75
33597	06 56349 0037	Size: 110,49 x 5,33 FPM 80
37003	06 56349 0077	Size: 135 x 2,5 FPM 80
84138	06 56820 0323	Size: 22 x 3 NBR 70
51533	06 56822 0223	Size: 13 x 3,5 NBR 70

O-ring/engine – various

dph-no.	OEM-no.	application
33968	06 56824 0177	Size: 4,2 x 1,9 FPM 80
110788	06 56824 0125	Size: 5 x 2,5 FPM 80
110789	06 56824 0302	Size: 17 x 2,5 FPM 80
48909	06 56824 0327	Size: 23 x 3 FPM 80
80790	06 56824 0410	Size: 28 x 3 FPM 75 green
32495	06 56824 0419	Size: 30 x 3 FPM 75 green
61535	06 56824 0428	Size: 32 x 2 FPM 80
34579	06 56824 0430	Size: 32 x 4 FPM 75 green
34167	06 56824 0502	Size: 24,2 x 3 FPM 80
34189	06 56824 0601	Size: 47 x 5,33 FPM 80
35730	06 56824 0608	Size: 50 x 3 FPM 80
61536	06 56824 0623	Size: 55 x 3 FPM 80
4120	06 56824 0624	Size: 55 x 2 FPM 80
68617	06 56832 0337	Size: 130 x 3 NBR 70
51743	06 56832 0508	Size: 170 x 4 NBR 70
33424	06 56832 0518	Size: 179 x 3 NBR 70
68570	06 56832 0523	Size: 180 x 4 NBR 70
34190	06 56834 0121	Size: 70 x 2 FPM 80
34168	06 56834 0126	Size: 74 x 3 FPM 75 green
15273	06 56834 0133	Size: 80 x 2,5 FPM 75 green
34191	06 56834 0225	Size: 100 x 3 FPM 80
93493	06 56930 3674	Size: 124 x 4 NBR 70

O-ring/engine – various

dph-no.	OEM-no.	application
80290	06 56930 3692	Size: 125 x 3,5 NBR 70
80291	06 56930 3880	Size: 138 x 3,5 NBR 70
81608	06 56930 4096	Size: 155 x 4 NBR 70
59314	06 56936 0347	Size: 7 x 3 FPM 70
109764	06 56936 0459	Size: 9 x 3 FPM 80
61638	06 56936 1051	Size: 20 x 2,5 FPM 75 green
94383	06 56936 2479	Size: 63 x 2,5 FPM 80
109766	06 56936 2632	Size: 70 x 3 FPM 70
82037	06 56936 2846	Size: 79,2 x 5,7 FPM 75 green
109765	06 56936 6409	Size: 24,5 x 2,5 FPM 80
51532	06 56938 0522	Size: 10 x 3 FPM 80
82109	06 56939 0017	Size: 7,5 x 1 NBR 70
82110	06 56939 0018	Size: 13 x 1 NBR 70
94649	06 56939 0029	Size: 67,5 x 4 FPM 75 green
82111	06 56939 0030	Size: 6,5 x 1,6 NBR 70
68517	06 56930 2618	Size: 69,5 x 3 NBR 70
96533	06 56930 3307	Size: 102 x 5 NBR 70
111083	51 96501 0493	Size: 138 x 2,1 FPM 75
110809	51 96501 0495	Size: 5,7 x 1,9 NBR 70
111034	51 96501 0500	Size: 93 x 4 FPM 80
110929	51 96501 0502	Size: 21 x 3 FPM 80
110821	51 96501 0507	Size: 7,52 x 3,53 FPM 80

O-ring/engine – various

dph-no.	OEM-no.	application
110835	51 96501 0518	Size: 10 x 2 ACM 60
111084	51 96501 0522	Size: 144 x 4 FPM 75 green
110825	51 96501 0524	Size: 8,1 x 1,6 NBR 70
110824	51 96501 0525	Size: 8 x 1,6 FPM 80
110886	51 96501 0526	Size: 15 x 2 FPM 80
110992	51 96501 0536	Size: 28,5 x 2 FPM 80
33147	81 05901 0009	Size: 128 x 5 NBR 70
111082	81 05902 0044	Size: 135 x 5 NBR 70
94464	81 08903 0089	Size: 210 x 8 NBR 70
36430	81 11904 0045	Size: 17 x 2 NBR 70
110852	81 12902 0070	Size: 11,5 x 2,5 FPM 80
110920	81 12902 0071	Size: 19,3 x 2,4 FPM 80
110901	81 61951 0046	Size: 11,1 x 1,78 Therban 70 green
110879	81 61951 0047	Size: 14 x 1,78 Therban 70 green
110850	81 61951 0048	Size: 17,17 x 1,78 Therban green
98097	81 96501 0000	Size: 103 x 2,5 NBR 70
80832	81 96501 0002	Size: 35,5 x 3 NBR 70
3934	81 96501 0288	Size: 118 x 4 NBR 70
35929	81 96501 0396	Size: 133 x 4,4 NBR 70
51470	81 96501 0411	Size: 116 x 4 NBR 70
80794	81 96501 0472	Size: 132,94 x 3,53 NBR 70
110894	81 96501 0537	Size: 16 x 2 NBR 70

O-ring/engine – various

dph-no.	OEM-no.	application
68556	81 96501 0577	Size: 15 x 2 FPM 80
68501	81 96501 0582	Size: 10 x 2 NBR 70
111016	81 96501 0595	Size: 38 x 2,5 NBR 70
6633	81 96501 0662	Size: 108 x 4 NBR 70
34394	81 96501 0671	Size: 52 x 3,5 NBR 70
111069	81 96501 0682	Size: 66,04 x 5,33 FPM 80
110916	81 96501 0683	Size: 18,72 x 2,62 FPM 70
110978	81 96501 0684	Size: 25 x 3,5 FPM 80
110808	81 96501 0710	Size: 5 x 2 NBR 70
110975	81 96501 0714	Size: 25 x 2,5 FPM 80
110997	81 96501 0719	Size: 31,34 x 3,53 FPM 80
110988	81 96501 0720	Size: 28,17 x 3,53 FPM 80
37175	81 96501 0767	Size: 22 x 2 FPM 80
111081	81 96501 0768	Size: 135 x 2,5 NBR 70
34395	81 96501 0774	Size: 8 x 2 NBR 70
35784	81 96501 0775	Size: 34 x 2,3 NBR 70
111004	81 96501 0789	Size: 33,5 x 4 NBR 75
111024	81 96501 0810	Size: 78 x 5 NBR 70
110882	81 96501 0816	Size: 14 x 2,5 NBR 70
6632	81 96501 0831	Size: 30 x 4,5 NBR 70
110930	81 96501 0890	Size: 21,3 x 2,4 NBR 70
110998	81 96501 0899	Size: 31,47 x 1,78 NBR 70

O-ring/engine – various

dph-no.	OEM-no.	application
110896	81 96501 0900	Size: 17 x 2 FPM 80
111001	81 96501 0901	Size: 33 x 2 NBR 80
111020	81 96501 0918	Size: 42 x 3 MVQ 70
110936	81 96501 0919	Size: 24 x 3 MVQ 70
110902	81 96501 0920	Size: 17,3 x 2,4 FPM 80
111033	81 96501 0922	Size: 86 x 2 NBR 70
111022	81 96501 0924	Size: 44,2 x 3 NBR 70
110976	81 96501 0945	Size: 25 x 2,5 NBR 90
111059	81 96501 0978	Size: 56,74 x 3,53 NBR 80
111026	81 96501 0979	Size: 78,97 x 3,53 NBR 70
111045	81 96501 0980	Size: 113,67 x 6,99 NBR 70
110979	81 96501 6003	Size: 25 x 4 MVQ 50 red
36772	81 96502 0012	Size: 39 x 3,5 FPM 80
111060	81 96502 0021	Size: 58,42 x 2,62 FPM 80
34360	81 96502 0044	Size: 9 x 1 NBR 70
34266	81 96502 0045	Size: 13 x 1 NBR 70
111085	81 96502 0049	Size: 148,6 x 6,99 NBR 90
110908	81 96502 0053	Size: 18 x 3 NBR 90
111018	81 96502 0057	Size: 40 x 2 FPM 80
110939	81 96502 0068	Size: 25 x 2 NBR 90
110883	81 96502 0075	Size: 14 x 3 NBR 90
110917	81 96502 0077	Size: 19 x 2 NBR 90

O-ring/engine – various

dph-no.	OEM-no.	application
111017	81 96502 0079	Size: 39,4 x 2,62 NBR 90
110885	81 96502 0087	Size: 14,3 x 2,4 NBR 70
111088	81 96502 0091	Size: 156 x 4 NBR 70
110858	81 96502 0097	Size: 13,95 x 2,62 NBR 90
111000	81 96502 0106	Size: 33 x 2,62 NBR 70
110812	81 96502 0107	Size: 6,07 x 1,78 NBR 70
110925	81 96502 0133	Size: 20,22 x 3,53 NBR 90
111080	81 96502 0144	Size: 130 x 3,5 NBR 70
111023	81 96502 0157	Size: 44,2 x 5,7 NBR 70
111078	81 96502 0158	Size: 124,2 x 5,7 NBR 70
111028	81 96502 0163	Size: 80 x 5 NBR 90
50909	81 96502 0175	Size: 88 x 3 NBR 70
110851	81 96502 0183	Size: 11,3 x 2,4 NBR 70
110803	81 96502 0185	Size: 2,9 x 1,78 FPM 80
110928	81 96502 0188	Size: 20,35 x 1,78 FPM 80
84507	81 96502 0201	Size: 82 x 3 MVQ 70
33153	81 96502 0255	Size: 20 x 3 FPM 75 green
111006	81 96502 0278	Size: 34 x 2,3 NBR 70
110811	81 96502 0280	Size: 6 x 2,5 NBR 70
111062	81 96502 0284	Size: 60 x 2,5 NBR 70
110817	81 96502 0285	Size: 6,5 x 2 FPM 80
110837	81 96502 0288	Size: 10 x 2,2 NBR 70

O-ring/engine – various

dph-no.	OEM-no.	application
110832	81 96502 0289	Size: 8,5 x 2,5 FPM 80
110854	81 96502 0300	Size: 12,3 x 2,4 NBR 70
110892	81 96502 0353	Size: 15,6 x 1,78 NBR 80
94696	81 96502 0359	Size: 9,5 x 1,5 NBR 70
110804	81 96502 0367	Size: 4 x 1 NBR 70
111068	81 96502 0384	Size: 66 x 2 NBR 70
111044	81 96502 0441	Size: 112 x 3 NBR 70
111095	81 96502 0467	Size: 297 x 4 FPM 80
111063	81 96502 0468	Size: 60 x 3 FPM 80
111035	81 96502 0469	Size: 95 x 4,5 FPM 80
111013	81 96502 0470	Size: 36 x 4 FPM 80
111005	81 96502 0540	Size: 34 x 1 NBR 70
111025	81 96502 0560	Size: 78,74 x 5,33 FPM 80
68557	81 96502 0638	Size: 28 x 2 FPM 80
111012	81 96502 0644	Size: 36 x 3 NBR 90
111010	81 96502 0645	Size: 35 x 4,5 NBR 90
110991	81 96502 0663	Size: 28,25 x 2,62 NBR 70
110989	81 96502 0672	Size: 28,2 x 3 NBR 70
110818	81 96502 0680	Size: 6,75 x 1,78 NBR 70
110855	81 96502 0685	Size: 12,42 x 1,78 NBR 70
110931	81 96502 0767	Size: 21,95 x 1,78 FPM 75
111073	81 96502 0768	Size: 75,8 x 3,53 FPM 80







O-ring/engine – various

dph-no.	OEM-no.	application
94864	81 96502 0771	Size: 21,82 x 3,53 MVQ 70
111097	81 96502 0776	Size: 425 x 3,5 FPM 80
110985	81 96502 0787	Size: 26,58 x 3,53 FPM
111027	81 96502 0850	Size: 78,97 x 3,53 NBR 80
110921	81 96502 0876	Size: 20 x 1,3 NBR 70
111066	81 96502 0897	Size: 63 x 2 FPM 80
111032	81 96502 0944	Size: 84,5 x 3 FPM 80
81582	81 96502 0958	Size: 17,13 x 2,62 NBR 70
111050	81 96502 0990	Size: 119,5 x 3 NBR 70
111079	81 96502 0991	Size: 124,5 x 3 NBR 70
110999	81 96502 0994	Size: 32,5 x 3 FPM 80
111014	81 96502 0997	Size: 37,69 x 3,53 FPM 80
111021	81 96502 0998	Size: 44,04 x 3,53 FPM 80
111092	81 96503 0020	Size: 190 x 5 NBR 70
110932	81 96503 0023	Size: 23 x 1,5 NBR 70
111074	81 96503 0032	Size: 77,2 x 5,7 FPM 80
93741	81 96503 0041	Size: 22 x 4 NBR 70
111052	81 96503 0055	Size: 47 x 3 NBR 70
111065	81 96503 0088	Size: 62 x 5 FPM 80
111030	81 96503 0089	Size: 82 x 5 FPM 80
111096	81 96503 0090	Size: 345 x 3,5 FPM 80
110829	81 96503 0099	Size: 8 x 2 NBR 70

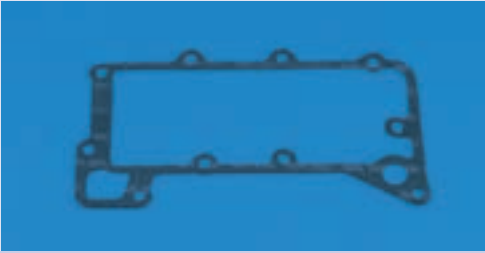

O-ring/engine – various

dph-no.	OEM-no.	application
110904	81 96503 0103	Size: 18 x 2,2 FPM 80
110927	81 96503 0107	Size: 20,3 x 2,4 EPDM 70
110899	81 96503 0130	Size: 17 x 2,5 EPDM 70
111019	81 96503 0137	Size: 40 x 4 EPDM 70
110888	81 96503 0173	Size: 15 x 2 MVQ 70
111002	81 96503 0211	Size: 33 x 2,5 NBR 70
110903	81 96503 0217	Size: 18 x 1,5 FPM 80
110833	81 96503 0221	Size: 9,1 x 1,6 FPM 80
110987	81 96503 0223	Size: 27,5 x 3 FPM 80
111029	81 96503 0224	Size: 81,2 x 5,7 FPM 80
110938	81 96503 0240	Size: 25 x 2 FPM 80
111042	81 96503 0243	Size: 105 x 3 FPM 80
111067	81 96503 0246	Size: 65 x 2,5 FPM 80
111061	81 96503 0249	Size: 60 x 2,5 FPM 80
110820	81 96503 0251	Size: 7,5 x 2 Therban green

Gasket

dph-no.	OEM-no.	application
80367	51 01222 0001	
80369	51 01222 0002	
93595 93490	51 05901 0107 51 05901 0116	
81915	51 06901 0108	
82294	51 54901 0012	
96123	51 54901 0027	 Spur gear cover
61543	51 54901 0028	

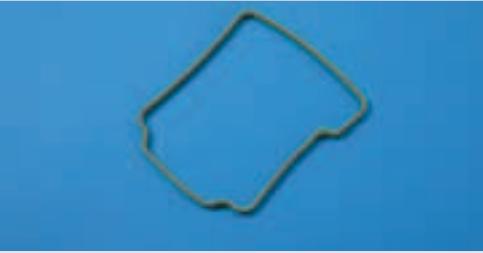
Gasket

dph-no.	OEM-no.	application
61544	51 54901 0029	
6397	51 96101 0048	Material: Viton 
4345	06 56639 0011	Bonded seal size: 6,7 x 11 x 1 

Gasket/engine

dph-no.	OEM-no.	application
111270	51 54901 0051	
35988	51 96501 0295	Injection 
3937	51 96501 0348	Engine 
94306	51 96001 0041	

Oil seal crankshaft

dph-no.	OEM-no.	application
36178	51 01510 0133	Size: 120 x 140 x 13 FPM AW/BS LD
80244	51 01510 0138	Size: 105 x 130 x 12 FPM AW/BS RD vlies
61236	81 96502 0350	
81122	51 01510 6004	
61360	51 01510 0150	
37179	51 01510 0141	Size: 120 x 140 x 13 FPM AW/BS LD
108819	51 01510 0196	

Oil seal crankshaft – front

dph-no.	OEM-no.	application
111394	51 01510 0152	Size: 60,4 x 80 x 12 BS SP RD FPM (dph 109799) D0224 MF , 66kW, 4 cyl. 102 dia. from 1980 D0226 M/MF/MFA 100kW, 6 cyl. dia. 102 from 1980 D0226 MKF/MC/MCFO 125/141 kW 6 cyl. dia 102 from 1984
109687	51 01510 0228	Size: 66 x 90 x 12 BS LA RD FPM D0824 4 cyl. dia. 108 D0824 GF , 75kW, 4 cyl. 108 dia from 1987 D0826 6 cyl. dia. 108 D0826 6 cyl. dia. 108 with crank-case cover
82544	51 01510 0197	Size: 105 x 130 x 12 FPM AW/BS RD vlies D2530 ME , oil filter reversible, exhaust not-cooled 10 cyl. dia. 125 D2530 ME with re-inforced bushing, exhaust not-cooled, 10 cyl. dia. 125 D2540 MTF/MTH up to engine 4584607063 10 cyl. dia. 125 D2542E with re-inforced bushing, from engine 4702001, 12 cyl. dia. 125 D2530 MF/MXH/MXF/MXFR 235 kW, 10 cyl. dia. 125 from 1971 D2530MTE with re-inforced bushing, exhaust not-cooled engine 4304585019 engine 4304590012 engine 4304614046 10 cyl. dia. 125 D2530 MTE with re-inforced bushing, exhaust water-cooled engine 4304585019 engine 4304590012 engine 4304614046 from engine 4304759011 10 cyl. dia. 125 D2530 ME with re-inforced bushing, exhaust water-cooled, 10 cyl. dia. 125 D2538 M/MF 189kW, 8 cyl. dia. 125 from 1972 D2538 ME with re-inforced bushing, from engine 465507, 8 cyl. Dia 125
		D2538 ME/MTE oil filter reversible, exhaust not cooled, 8 cyl. dia. 125 D2538 MT , 237kW, 8 cyl. dia. 125 from 1973 D2538 MTE with re-inforced bushing, from engine 4655076, 8 cyl. dia. 125 D2540 MLE with re-inforced bushing, exhaust water-cooled, from engine 4534610068, 10 cyl. dia. 125 D2540 MTE with re-inforced bushing, engine 4514598038 engine 4514598039 engine 4514598040 from engine 4514615058 10 cyl. dia. 125 D2540 MTF/MTH with re-inforced bushing, from engine 4584607064, 10 cyl. dia. 125 D2530 MXF/MXFR with re-inforced bushing, exhaust not-cooled 10 cyl 125 dia D2566 MUH from engine 3294091103 D2566 MUM from engine 3394097095 6 cyl. dia. 125 D2542 MT/ME with re-inforced bushing, 12 cyl. dia. 125 D2542 ME oil filter reversible, exhaust not-cooled 12 cyl. dia. 125 D2542 ME with re-inforced bushing, exhaust water-cooled, from engine 4704650001 12 cyl. dia. 125 D2542 MLE exhaust not-cooled, without air-compressor from engine 4904675003 12 cyl. dia. 125

Oil seal crankshaft – front

dph-no.	OEM-no.	application
		D2542 MLE with re-inforced bushing, exhaust water-cooled from engine 4904675003 12 cyl. dia. 125
		D2542 MLE 12 cyl. dia. 125
		D2542 MTE with re-inforced bushing, exhaust water-cooled, from engine 48046540006 12 cyl. dia. 125
		D2542 MTE oil filter reversible, exhaust not-cooled 12 cyl. dia. 125
		D2555 M/MF/MX/MXF 5 cyl. dia. 125
		D2555 MXE without air-compressor exhaust not-cooled, fuel filter not reversible 5 cyl. dia. 125
		D2555 MXUH/MXUL
		D2565 MXUH/MXUL up to engine 4135000, 5 cyl. dia. 125
		D2565 M/MF/MFR/MH/MHO/MR 5 cyl. dia. 125
		D2565 ME without air-compressor, exhaust not-cooled 5 cyl. dia. 125
		D2556 MXUH/MXUM up to engine 4091102
		D2566 MUM from engine 4095094
		D2566 UH/UH-200/UM 6 cyl. dia. 125
		D2566 M/MR/MF/MFR up to engine 4091059 D2566MFG up to engine 4092000 D2566 MFO/FMOR up to engine 4093057 D2566 MH/MHO up to engine 4092102 6 cyl. dia. 125
		D2566 M/MR/MF/MFR/MFO/MFOR from engine 4099001 6 cyl. dia. 125
		D2566 ME from engine 4094086
		D25566 MTE from engine 4069119 6 cyl. dia. 125
		D2566 MFG from engine 4092001 6 cyl. dia. 125
		D2566 MK/MKF/MKH/MK-Sibmas 1 cyl air-compressor 6 cyl. dia. 125
		D2566 MLE exhaust not-cooled 6 cyl. dia. 125
		D2566 MLUM USA/Canada 6 cyl. dia. 125
		D2566 MT/MTF/MTH/MTHO/MTFG 6 cyl. dia. 125
		D2566 MTUE/MTUH/MTUM USA 6 cyl. dia. 125
		D2840 LE/LF 338kW/LF01/04/06/20/21/LXE/ME exhaust water-cooled
		D2840 MF/MFR/MH 10 cyl. dia. 128
		D2842 LXE/LYE/LYZ/LEE + D2842 ME exhaust water-cooled 12 cyl. dia. 128
		D2848 LE/LXE/M 8 cyl. dia. 128
		D2865 LF/LFR/LXF/LXFR/LF01../LF21-24, LFR01.. LOH01/02/05/07-09 5 cyl. dia. 128
		D2865 LU 01-03 5 cyl. dia. 128
		D2865 LUH02/03/05-09 5 cyl. dia. 128
		D2866 F/FR, DOH01/DF01
		D2866 FZR/FG/OH
		D2866 KF/KFZ/KH/KOH, LOH02/03/06/07, LXOH, LF02-10/14-16, LFZ/LFZR, LH01-02/LXF
		D2866 LF20/21/22, LF29/30
		D2866 LE/TE 6 cyl. dia. 128
		D2866 UH/UM/TUH/TUM/KUH/KUL/LXU/LU/LUL/LUH 6 cyl. dia. 128
		D2866 LUH20/21/22/26 6 cyl. dia. 128
		D2876 LF01/LF02/LOH01 6 cyl. dia. 128
		E2542 E with re-inforced bushing, exhaust water-cooled from engine 4702001 12 cyl. dia. 125
		E2542 E exhaust water-cooled, oil filter not reversible 12 cyl. dia. 125
		E2542 E exhaust not-cooled, oil filter reversible 12 cyl. dia. 125

Oil seal crankshaft – back

dph-no.	OEM-no.	application
109688	51 01510 0151	Size: 110x130x13 BS SP LD FPM/PTFE
		D 0224 MF , 66kW, 4 cyl. 102 dia from 1980
		D0226 M/MF/MFA 100 kW, 6 cyl. dia. 102 from 1980
		D0226 MKF/MC/MCFO 125/141 kW 6 cyl. dia 102 from 1984
70512	51 01510 0206	Size: 120 x 140 x 13 FPM AW/BS LD
		D2530 ME , oil filter reversible, exhaust not-cooled, 10 cyl. dia. 125
		D2530 ME with re-inforced bushing, exhaust not-cooled, 10 cyl. dia. 125
		D2540 MTF/MTH up to engine 4584607063 10 cyl. dia. 125
		D2542 E with re-inforced bushing, from engine 4702001, 12 cyl. dia. 125
		D0824 4 cyl. dia. 108
		D0824 GF , 75kW, 4 cyl. 108 dia from 1987
		D0826 6 cyl. dia. 108
		D0826 6 cyl. dia. 108 with crank-case cover
		D2530 MF/MXH/MXF/MXFR 235 kW, 10 cyl. dia. 125 from 1971
		D2530 MTE with re-inforced bushing, exhaust not-cooled engine 4304585019 engine 4304590012 engine 4304614046 10 cyl. dia. 125
		D2530 MTE with re-inforced bushing, exhaust water-cooled engine 4304585019 engine 4304590012 engine 4304614046 from engine 4304759011 10 cyl. dia. 125

Oil seal crankshaft – back

dph-no.	OEM-no.	application
70512	51 01510 0206	<p>D2530ME with re-inforced bushing, exhaust water-cooled 10 cyl. dia. 125 D2538 M/MF 189kW, 8 cyl. dia. 125 From 1972</p> <p>D2538 ME with re-inforced bushing, from engine 465507, 8 cyl. Dia 125 D2538ME/MTE oil filter reversible, exhaust not-cooled, 8 cyl. dia. 125</p> <p>D2538MT, 237kW, 8 cyl. dia. 125 From 1973 D2538MTE with re-inforced bushing, from engine 4655076, 8 cyl. dia. 125</p> <p>D2540 MLE with re-inforced bushing, exhaust water-cooled, from engine 4534610068, 10 cyl. dia. 125</p> <p>D2540 MTE with re-inforced bushing, Engine 4514598038 Engine 4514598039 Engine 4514598040 From engine 4514615058 10 cyl. dia. 125</p> <p>D2540 MTF/MTH with re-inforced bushing, from engine 4584607064, 10 cyl. dia. 125 D2530MXF/MXFR with re-inforced bushing, exhaust not cooled, 10 cyl 125 dia</p> <p>D2566MUH from engine 3294091103 D2566MUM from engine 3394097095 6 cyl. dia. 125 D2542 MT/ME with re-inforced bushing, 12 cyl. dia. 125</p> <p>D2542ME oil filter reversible, exhaust not-cooled 12 cyl. dia. 125</p> <p>D2542ME with re-inforced bushing, exhaust water-cooled, from engine 4704650001 12 cyl. dia. 125</p> <p>D2542MLE exhaust not-cooled Without air-compressor from engine 4904675003 12 cyl. dia. 125</p> <p>D2542MLE with re-inforced bushing, exhaust water-cooled, from engine 4904675003 12 cyl. dia. 125 D2542 MLE 12 cyl. dia. 125 dia</p> <p>D2542MTE with re-inforced bushing, exhaust water cooled, from engine 48046540006 12 cyl. dia. 125 D2542MTE oil filter reversible, exhaust not cooled 12 cyl. dia. 125</p> <p>D2555 M/MF/MX/MXF 5 cyl. dia. 125 D2555MXE without air-compressor, exhaust not cooled, fuel filter not reversible 5 cyl. dia. 125 D2555 MXUH/MXUL D2565 MXUH/MXUL up to engine 4135000, 5 cyl. dia. 125</p> <p>D2565 M/MF/MFR/MH/MHO/MR 5 cyl. dia. 125 D2565ME without air-compressor exhaust not-cooled 5 cyl. dia. 125 D2556 MXUH/MXUM up to engine 4091102 D2566 MUM from engine 4095094 D2566 UH/UH-200/UM 6cyl. dia. 125</p> <p>D2566 M/MR/MF/MFR up to engine 4091059 D2566MFG up to engine 4092000 D2566 MFO/FMOR up to engine 4093057 D2566 MH/MHO up to engine 4092102 6 cyl. dia. 125</p> <p>D2566 M/MR/MF/MFR/MFO/MFOR from engine 4099001 6 cyl. dia. 125</p> <p>D2566ME from engine 4094086 D25566 MTE from engine 4069119 6 cyl. dia. 125 D2566MFG from engine 4092001 6 cyl. dia. 125 D2566 MK/MKF/MKH/MK-Sibmas 1 cyl air-compressor 6 cyl. dia. 125</p> <p>D2566MLE exhaust not-cooled 6 cyl. dia. 125</p> <p>D2566 MLUM USA/Canada 6 cyl. dia. 125</p> <p>D2566 MT/MTF/MTH/MTHO/MTFG 6 cyl. dia. 125 D2566 MTUE/MTUH/MTUM USA 6 cyl. dia. 125 D2840 LE/LF 338kW/LF01/04/06/20/21/LXE/ME exhaust water cooled</p> <p>D2840 MF/MFR/MH 10 cyl. dia. 128</p> <p>D2842 LXE/LYE/LYZ/LEE + D2842 ME Exhaust water-cooled 12 cyl. dia. 128</p> <p>D2848 LE/LXE/M 8 cyl. dia. 128</p> <p>D2865 LF/LFR/LXF/LXFR/LF01../LF21-24, LFR01.. LOH01/02/05/07-09 5 cyl. dia. 128 D2865 LU 01-03 5 cyl. dia. 128</p> <p>D2865 LUH02/03/05-09 5 cyl. dia. 128</p> <p>D2866 F/FR, DOH01/DF01 D2866 FZR/FG/OH D2866KF/KFZ/KH/KOH, LOH02/03/06/07, LXOH, LF02-10/14-16, LFZ/LFZR, LH01-02/LXF D2866 LF20/21/22, LF29/30 D2866 LE/TE 6 cyl. dia. 128</p> <p>D2866 UH/UM/TUH/TUM/KUH/KUL/LXU/LU/LUL/LUH 6 cyl. dia. 128 D2866 LUH20/21/22/26 6 cyl. dia. 128</p> <p>D2876 LF01/LF02/LOH01 6 cyl. Dia 128</p> <p>E2542E with re-inforced bushing, exhaust water cooled, from engine 4702001 12 cyl. dia. 125</p> <p>E2542 E exhaust water cooled, oil filter not reversible 12 cyl. dia. 125</p> <p>E2542E exhaust not-cooled, oil filter reversible 12 cyl. dia. 125</p>

Clutch, gearbox

Transmission oil seal



dph-no.	OEM-no.	application
35090	06 56261 1615	Size: 25 x 52 x 7 NBR B
4716	06 56261 1911	Size: 30 x 40 x 7 NBR B
35092	06 56271 0807	Size: 50 x 65 x 8 NBR B
35094 35116	06 56272 0047 06 56275 0047	Size: 52 x 72 x 12 NBR BS
35115	06 56279 0042	Size: 48 x 65 x 10 NBR B
35117	06 56279 0050	Size: 55 x 80 x 13 NBR B
35127	06 56279 0087	Size: 48 x 62 x 10 NBR B
96080	06 56279 0147	Size: 62 x 80 x 10 NBR B
96079	06 56279 0148	Size: 62 x 80 x 10 FPM B
35147 68541	06 56289 0033 06 56289 0167	Size: 85 x 105 x 13 NBR BS blue

Transmission oil seal

dph-no.	OEM-no.	application
96083	06 56289 0139	Size: 90 x 110 x 15 AW/BD FPM
80482	06 56289 0191	Size: 80 x 100 x 12
110696	06 56289 0191	FPM B NBR BS
93449	06 56289 0236	Size: 110 x 140 x 13 NBR CS
93804	81 96502 0761	Size: 55 x 75 x 8 FPM B RD
80059	81 96502 0349	Size: 105 x 130 x 12 NBR A
34634	81 96502 0248	Size: 48 x 65 x 10 NBR B
82737 35690	81 96502 0247 06 56289 0132	Size: 85 x 105 x 10 NBR B blue
69158	81 96502 0226	Size: 48 x 69 x 10 NBR B RD green
93757	81 96502 0225	Size: 48 x 75 x 8 FPM B RD brown
50681	81 96502 0208	Size: 85 x 105 x 10 FPM B LD
96084	81 96501 0864	Size: 25 x 35 x 7 NBR B
35204	81 96501 0306	Size: 7 x 16 x 7 NBR B
35208	81 96501 0388	Size: 22 x 30 x 7 NBR B
35209	81 96501 0445	Size: 55 x 80 x 10 NR A
35210	81 96501 0446	Size: 85 x 105 x 10 NBR B
35211	81 96501 0448	Size: 42 x 60 x 10 NBR B
35212	81 96501 0521	Size: 25 x 35 x 7 NBR B

O-ring/clutch-/gearbox

dph-no.	OEM-no.	application
36751	06 56332 4206	Size: 5,28 x 1,78 NBR 70
3933	06 56342 2216	Size: 68 x 4 NBR 70

● Clutch servo cylinder

dph-no.	OEM-no.	application
94384	81 30725 6027	Wabco 970 051 1110
94466	81 30725 6031	Wabco 970 051 1320



Brake parts/air brake components

Diaphragm

dph-no.	OEM-no.	application
81625	897 120 5164	 16" Long stroke
84630	897 120 5204	 20" Normal stroke
81626	897 120 5264	 20" Normal stroke
81624	897 120 5364	 24" Long stroke
81623	897 120 5464	 30" Long stroke

Front and rear axle parts, steering

Oil seal for front & rear axle



dph-no.	OEM-no.	application
35152	06 56289 0040	Size: 145 x 165 x 13 NBR C
35153	06 56289 0045	Size: 175 x 200 x 15 NBR C green
35157	06 56292 0101	Size: 200 x 230 x 15 NBR C

Oil seal for front axle

dph-no.	OEM-no.	application
69795	06 56279 0031	Size: 50 x 70 x 10/14 NBR BS blue
82931	06 56279 0025	Size: 57 x 75 x 7,5/6 AS K blue NBR
35110	06 56279 0028	Size: 72 x 105 x 13 BS green NBR
80537	06 56279 0029	Size: 50 x 70 x 8 NBR C blue
96525	06 56279 0095	Size: 42 x 55 x 9 FPM B
69190	06 56279 0181	Size: 64 x 80 x 13 NBR AS blue
33649	06 56281 0605	Size: 100 x 130 x 13 AW/BS NBR



Oil seal for front axle

dph-no.	OEM-no.	application
109419	06 56282 1007	Size: 120 x 150 x 15/12 CS NBR
35131	06 56289 0013	Size: 165 x 190 x 13 NBR C
35150	06 56289 0037	Size: 115 x 140 x 13 NBR CS green
51458 35155	06 56289 0050 06 56289 0052	Size: 160 x 180 x 10/11 BS blue NBR
82278	06 56289 0215	Size: 95 x 115 x 13 NBR CS green
35259	06 56289 0267	Size: 100 x 130 x 13 NBR AW/BS
80283	06 56289 0221	Size: 120 x 150 x 15/12 CS NBR
84396	81 96501 0842	Size: 42 x 55 x 9 FPM B
95830	81 96501 0941	Size: 30 x 35 x 4 BO NBR

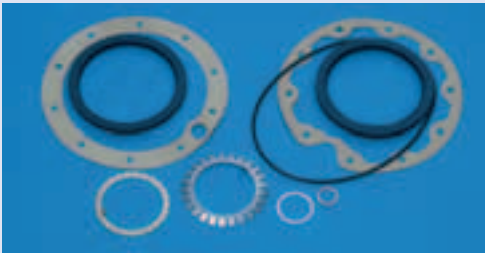
Repair kit for ABS rear axle

dph-no.	OEM-no.	application
81895		<p>Gasket set for outside planetary gear with steel plug</p> <p>Contents:</p> <ul style="list-style-type: none"> 1 pc lock plate dia 121 MAN 81 908010224 1 pc oil seal outside MAN 06 56289 0064 size: 145x175x14 NBR 1 pc oil seal inner MAN 06 56289 0063 size: 145x175x13 NBR <p>1 pc O-ring black MAN 06 56341 4254 size: 255x5</p> <p>1 pc paper gasket steel plug</p> <p>1 pc washer MAN 06 56190 0822 size: 24x29x2 CU</p> <p>1 pc washer MAN 06 56200 0811 size: 45x52x2 ALU</p>
94501		 <p>Combi gasket kit Outside Planetary Gear</p> <p>Contents:</p> <ul style="list-style-type: none"> 1 pc lock plate dia 121 MAN 81 908010224 1 pc lock plate dia 106 1 pc oil seal outside size: 145x175x14 NBR 1 pc oil seal inner size: 145x175x13 NBR 1 pc O-ring green size: 255x5 FPM 1 pc paper gasket steel plug 1 pc paper gasket cast iron plug 81 96601 0298 1 pc washer MAN 06 56190 0822 size: 24x29x2 CU 1 pc washer MAN 06 56200 0811 size: 45x52x2 ALU
80056		 <p>Combi gasket kit Outside Planetary Gear</p> <p>Contents:</p> <ul style="list-style-type: none"> 1 pc lock plate dia 121 MAN 81 908010224 1 pc lock plate dia 106 1 pc oil seal outside MAN 06 56289 0064 size: 145x175x14 NBR 1 pc oil seal inner MAN 06 56289 0063 size: 145x175x13 NBR 1 pc O-ring black MAN 06 56341 4254 size: 255x5 NBR 1 pc paper gasket steel plug 1 pc paper gasket cast iron plug MAN 81 96601 0298 1 pc washer MAN 06 56190 0822 size: 24x29x2 CU 1 pc washer MAN 06 56200 0811 size: 45x52x2 ALU

Repair kit for ABS rear axle

dph-no.	OEM-no.	application	
81548			<p>Contents:</p> <ul style="list-style-type: none"> 1 pc lock plate dia 121 MAN 81 908010224 1 pc oil seal outside MAN 06 56289 0064 size: 145x175x14 NBR 1 pc oil seal inner MAN 06 56289 0063 size: 145x175x13 NBR 1 pc O-ring black MAN 06 56341 4254 size: 255x5 1 pc paper gasket 1 pc washer MAN 06 56190 0822 size: 24x29x2 CU 1 pc washer MAN 06 56200 0811 size: 45x52x2 ALU
81438			<p>Contents:</p> <ul style="list-style-type: none"> 1 pc lock plate dia 121 81 90801 0224 1 pc lock plate dia 106 1 pc oil seal outside ABS Pole wheel 06 56289 0371 size: 145x175/205x9/14 1 pc oil seal inner size: 145x175x13 FPM 1 pc O-ring green size: 255x5 FPM 1 pc paper gasket steel plug 1 pc paper gasket cast iron plug 81 96601 0298 1 pc washer 06 56190 0822 size: 24x29x2 CU 1 pc washer 06 56200 0811 size: 45x52x2 ALU

Repair kit for ABS front axle

dph-no.	OEM-no.	application	
81896		Gasket set for outside planetary gear with cast iron plug	<p>Contents:</p> <ul style="list-style-type: none"> 1 pc lock plate dia 121 MAN 81 908010224 1 pc oil seal outside MAN 06 56289 0050 size: 80x160x10/11 NBR 1 pc oil seal inner MAN 06 56289 0052 size: 160x180x10 NBR 1 pc O-ring black MAN 06 56341 3271 size: 270x6 1 pc paper gasket 1 pc washer MAN 06 56190 0822 size: 24x29x2 CU 1 pc washer MAN 06 56200 0811 size: 45x52x2 ALU

Oil seal for rear axle

dph-no.	OEM-no.	application
35097	06 56272 1312	Size: 60 x 80 x 10 NBR C
35106	06 56272 2016	Size: 75 x 100 x 12 C NBR
84399	06 56272 8016	Size: 75 x 100 x 12 FPM C
35107	06 56274 1714	Size: 68 x 90 x 10 NBR C
35121	06 56279 0057	Size: 62 x 75 x 10 NBR B
48119	06 56279 0183	Size: 75 x 95 x 12,5 BS NBR blue
80282	06 56279 0184	Size: 68 x 90 x 12,5 BS NBR blue
81190	06 56279 0215	Size: 75 x 95 x 10/9,5 FPM B WD

Oil seal for rear axle





dph-no.	OEM-no.	application
35129	06 56282 1813	Size: 170 x 200 x 15 NBR C
80281 35264	06 56279 0114 06 56279 0133	Size: 42 x 58 x 7 BS NBR
34633	06 56289 0022	Size: 80 x 100 x 13 BS NBR
34647 82113 6652	06 56289 0027 06 56289 0332 06 56289 0335	Size: 145 x 175 x 14 A/BS W blue NBR
35149	06 56289 0035	Size: 110 x 130 x 13 NBR C
35151	06 56289 0039	Size: 135 x 160 x 13 C NBR
32782	06 56289 0041	Size: 145 x 170 x 15 NBR C
33421 68551	06 56289 0047 06 56289 0048	Size: 85 x 105 x 13 FPM B WD
34818 34645 32639	06 56289 0064 06 56289 0145 06 56289 0334	Size: 145 x 175 x 13 NBR A/BW
84522	06 56289 0066	Size: 145 x 175 x 13 FPM AW/B
84394	06 56289 0186	Size: 140 x 160 x 13 BS NBR blue
82322	06 56289 0309	Size: 145 x 175 x 16 FPM AW/BS WD
82320	06 56289 0371	Size: 145 x 175/205 x 9/14 NBR special
84198	81 96501 0843	Size: 42 x 58 x 7 NBR BS
109841	81 96501 0860	Size: 145 x 175 x 13 FPM C
6649	81 96501 0861	Size: 145 x 175 x 14 NBR A/BS W blue
94714	81 96501 0026	Size: 160 x 190 x 15 NBR C green
35202	81 96501 0136	Size: 120 x 150 x 13 NBR C





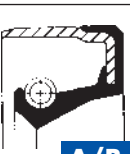

O-ring/rear axle

dph-no.	OEM-no.	application
6525	06 56341 4254	Size: 255 x 5 NBR 70

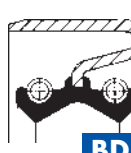

Overview of most popular oil seal types acc to DIN 3760/3761

Application	Description
 A	rubber version with single lip
 AS	rubber version with sealing and dust lip
 AD	rubber version with 2 lips and 2 springs
 AW	rubber version with sealing lip and corrugated profile
 ASW	rubber version with sealing lip and dust lip and corrugated profile
 A/B	seal with combined elastomer/ metal outer cover

Application	Description
 B	metal cased open
 BS	metal cased open with dust lip
 C	metal cased closed
 CS	metal cased closed with dust lip
 BD	metal cased open with 2 lips
 A/BS	seal with combined elastomer/ metal outer cover with dust lip

Abbreviations at „style“

FL Washer
PR Profile seal
OR O-Ring
WR Oil seal

Complimentary definitions

RD Right hand helix
LD Left hand helix
WD Double helix
SF Special design
OF Without spring
V Reinforced seal lip
LA With sealant film
W Corrugated profile
SP Special

Abbreviations at „mat“ (material)

ACM Polyacryl rubber
FPM Fluor rubber (Viton)
MVQ Silicone rubber
NBR Nitril rubber
EPDM Ethylen-Propylen-Dien-rubber
PTFE Polyterafluorethylen
HNBR Hydrogenated NBR
AL Aluminium
CU Copper
FE Iron
FZ Felt

Standard terms and conditions

Standard Terms and Conditions of Trade and Delivery, as established by Dichtungspartner Hamburg GmbH, Ferdinand-Harten-Str. 15, 22949 Ammersbek, Germany, hereafter referred to as "dph":

Application

The terms and conditions set out below form part of all contracts for services, supplies and quotations by dph. Sales shall be made solely on the basis of the terms and conditions below. Ancillary agreements and amendments shall only be deemed valid if in writing.

If our contracting partner has its own terms and conditions which differ from dph's terms and conditions, we shall only be bound by the aforementioned terms and conditions of the contracting partner if we specifically accepted them in writing on conclusion of the contract. We hereby specifically state that we shall not accept a counter-confirmation by the customer with reference to its own terms and conditions.

Quotations

All quotations are subject to change. We shall not be bound by any arrangements made orally, by telegraph or telephone until we have issued a written confirmation. Any details given in brochures, advertisements, etc., including prices, shall not be binding until specifically agreed in writing.

Prices

Our prices are given in euros (EUR) ex works and exclude German VAT. Prices exclude postage/delivery, packing and insurance.

Delivery

1. Prices are given ex works. Unless free delivery has been agreed, the purchaser shall bear the costs associated with dispatch/shipment. It shall also bear costs ex delivery destination. Freight refunds are not granted. The goods shall be insured only if the customer so requests in writing, and insurance shall be at the customer's expense.
2. Collection and dispatch of the goods ex works or distribution warehouse is in all cases at the customer's risk.
3. We reserve the right to charge a minimum-quantity flat rate or a minimum cost-contribution flat rate for small orders.
4. In the case of blanket/call orders, we are entitled to procure the material for the whole order and to manufacture the entire quantity ordered immediately. Any change requests by the customer cannot be accepted after the order has been placed, unless this was specifically agreed.

Payment

1. Our invoices are payable in euro (EUR).
2. Invoiced amounts are payable (free of dispatch costs and other expenses) within 14 days after invoice date less 2% discount, or within 30 days after invoice date without deduction. Default interest is payable at the rate of 8% above the base interest if payment is late.
3. Cheques shall be regarded as cash payments, provided they have been sent to us in sufficient time that they can be cashed within the above payment periods.
4. Only payments made at the place of performance have the effect of discharging obligations. Payments made to employees of our company shall only discharge obligations if such employees have the appropriate collecting power (Inkassovollmacht).
5. If it becomes apparent after conclusion of the contract that our claim to payment may be in jeopardy because the customer is not able to discharge its obligations, then any other debt claims we have shall become due and payable immediately. In this event, we are entitled to make any remaining deliveries subject to payment in cash or the provision of security. This will not affect any further legal claims.
6. The customer may only set off payments against counterclaims which we have accepted or which have the authority of a final court judgment. This also applies to the retention of payments.

Tools and equipment

Tools and equipment which we manufacture or engage a third party to manufacture shall be our property, even if our customer pays part of the manufacturing costs.

Packaging

Paper packaging shall be subject to the lowest-possible charge. Chests, crates, barrels, sacks and other types of packaging shall be invoiced and, if returned freight-paid and in good condition within 4 weeks after receipt of the delivery, a credit note will be issued for 2/3 of the amount charged. In the event that a rail company classifies a delivery as inadequately packed, this may not be used against us.

Periods of delivery

1. The periods of delivery shall begin when all details of the order have been explained, however, not before the purchaser has fulfilled any contractual obligations which must be performed beforehand. The delivery date is deemed to have been met if the goods have left the warehouse by the end of such date or, if the delivery is delayed for reasons not attributable to us, on notification that the goods are ready for dispatch within the agreed period of delivery.
2. The delivery obligation is subject to the condition that dph has been supplied correctly and in due time by its suppliers.
3. Partial deliveries within the agreed time and quantities are permissible and may be invoiced separately.
4. If any acts of force majeure, industrial disputes or their consequences or other events which are outside the scope of our control delay the performance of our delivery obligation, regardless of whether they affect us or our sub-contractors, the period of delivery shall be extended by the length of such delay. Both parties shall have the right to cancel the contract if the delivery later becomes impossible or unreasonable for one of the parties due to an event of the above nature.
5. The purchaser is entitled to terminate the contract, in accordance with the legal provisions, in the event of delay or if delivery is impossible for reasons attributable to us. If the delivery is delayed and if the purchaser thereby suffers loss, it is entitled to demand a lump-sum amount as compensation for the delay. Such compensation shall be, for each full week of delay, 0.5% of the value of that portion of the total delivery which, as a result of the delay, cannot be used on time or in accordance with the contract, up to a maximum of 5% of such value.
6. If delivery is delayed at the purchaser's request, the purchaser shall be charged the costs of storage, commencing 2 weeks after notification that delivery is ready, subject to a minimum charge of 1% of the invoice amount for each week.

Tolerances

Any recommendations we give as to the use of our products are made to the best of our knowledge. The purchaser is at all times under an obligation to satisfy itself by means of its own enquiries that the goods delivered are suitable for the intended purpose. Deviations from samples and earlier deliveries are permissible if they do not affect quality and use. We reserve the right to deviations in quantity of $\pm 10\%$.

Complaints and liability for defects

1. Immediately after receipt, the purchaser must inspect the goods and give written notification promptly, or no later than within 10 days after receipt, of any obvious visible defects, incorrect quantities or incorrect deliveries, specifying the defect. In the case of latent defects, it must do this within 10 days after discovery of the defect.
2. If there are defects, we guarantee as follows: We shall, at our discretion, replace free of charge or repair all parts which prove to be unusable or whose use is not inconsiderably affected as a result of circumstances existing before risk was transferred.

- The purchaser is entitled to rescission of the contract or to a reduction in price if we allow a reasonable extension of time for post-performance or repairs to elapse without resolving the defect, or if more than one attempt at post-performance or repair does not resolve the defect. If we deliver a defect-free item for the purpose of supplementary performance, or if the purchaser rescinds the contract, then it must pay value-related compensation for the benefit derived. The value of the benefit derived shall be determined by pro rata temporis straight-line depreciation in the ratio between the actual period of use and the estimated useful life.
- The statutory limitation period of 2 years shall apply to notification of defects under Section 437 BGB (Bürgerliches Gesetzbuch – German Civil Code).
- The provisions below under "General Liability" shall apply to liability to pay compensatory damages for liability for defects.

General liability

- Without prejudice to the provisions under point 5 of "Periods for delivery", claims for damages of any kind in connection with and apart from liability for defects are excluded – for delay or impossibility, for breach of other contractual obligations, for mistakes on conclusion of the contract, for tort or for any other legal reason, in particular also for damages which do not occur to the items delivered themselves. There shall only be liability where there is intentional conduct, gross negligence, culpable injury to life, limb or health, defects which we have fraudulently concealed, on assumption of a warranty made regarding the existence of any specific feature or for defects in the items delivered, to the extent that there is liability under product liability laws for material damage to privately used items and for personal injury.
- We shall also be liable for culpable breach of essential contractual obligations. However, provided there is no gross fault, such liability shall be limited to damage which is deemed typical as regards this type of contract and reasonably foreseeable.

Returns

Returns which are not based on a legal claim shall only be accepted, carriage paid, with our express written consent. As compensation for the costs incurred on any return, we shall retain from the credit note a corresponding reduction in the net invoiced value of the goods, subject to a minimum of 20% of the net invoiced value of the goods.

Reservation of title

- The goods delivered shall remain our property until all outstanding amounts owed to us in connection with the business relationship, including incidental expenses, have been paid. If operating an open account, the property subject to the reservation of title shall be deemed to be security for our current account.
- If our goods are combined or mixed with other goods which do not belong to us, we shall have joint ownership in the new object or the mixed item in proportion to the invoice value of the goods subject to the reservation of title compared with the value of the other combined or mixed goods at the time they were combined or mixed. If, as a result of combination, the purchaser acquires sole ownership in the new item, it hereby assigns to us joint ownership in the new item in proportion to the invoice value of our goods subject to the reservation of title compared with the value of the other combined goods remaining at the time they were combined, and shall keep such item in custody for us using the care of a prudent merchant.
- Resale of the goods delivered, even if combined or mixed, is only permitted to resellers in the usual course of business and subject to the reservation of title and only if the debt claim arising from the resale is assigned to us. The purchaser may not pledge the goods as collateral nor transfer ownership therein by way of security, nor may it agree on a non-assignment clause. The purchaser must notify us immediately if there is any pledge or any other third-party action which may affect our rights.
- The purchaser hereby assigns to us in advance any outstanding debts owed to it from the resale or for any other legal reason in respect of the goods we have supplied, both existing and arising in future as soon as they come into being. We accept such assignment. The value of the goods subject to the

reservation of title shall be our invoice amount plus a security premium of 10% which shall however not apply if third-party rights present an obstacle to this. If our goods are resold after they have been combined or mixed with other goods, or if the new item which arises through combination is resold, the claim against the purchaser's customer will be assigned in the amount of the invoice value of our processed, combined or mixed item, or up to the amount which corresponds to our share in the joint property, if this is lower.

- The purchaser is entitled to collect the debt claims assigned provided that it duly fulfils its payment obligations to us.
- If the value of the security assigned to us exceeds our debt claims by more than 10% in total, we are under an obligation to release the securities of our choice upon request by the purchaser. Ownership in the goods subject to the reservation of title and the assigned debt claims shall pass to the customer on payment of all our debt claims in connection with the business relationship.

Property rights

If we have made our supplies in accordance with drawings, models, samples or other documents provided by the purchaser, the purchaser guarantees that third-party property rights are not breached. If a third party claims in such a case that we are breaching a property right, e.g. through the manufacture or supply of the goods, then we shall be entitled, without further inspection, to discontinue our activity subject to our other rights. The purchaser undertakes to notify us immediately if there are any risks of breach or alleged cases of breach as soon as they become known.

Place of performance, jurisdiction, applicable law, general

- The place of performance for deliveries and payments is Ammersbek. The courts of Ahrensburg will have jurisdiction for any disputes with traders or with people who do not have a legal domicile within Germany – even in the cases involving bills of exchange and cheques. We are also entitled, at our discretion, to bring an action against the purchaser before the courts which have jurisdiction in the place where the purchaser has its head office.
- German law will apply to the contractual relationship. The provisions of UN sales of goods law will not apply.
- The latest version of Incoterms 2000 will apply if clauses defined in the Incoterms are agreed.

Data storage

As required by Section 28 of the Bundesdatenschutzgesetz (Federal Data Protection Act - BDSG), we draw attention to the fact that the data necessary for the purposes of our business will be processed and stored using data processing equipment in accordance with Section 33 of the BDSG. The purchaser agrees that we may use the data obtained from our business relationship with it, in accordance with data privacy provisions, only for our own business purposes.

Severability and concluding provision

If any individual provisions of these Terms and Conditions should be void, this shall not affect the validity of the remaining provisions. Any provision which is void will be replaced by a valid provision which comes as close as possible to the purpose sought by the void provision. This is an English translation of the original Standard Terms and Conditions. In the event of any conflict or inconsistency between the English translation and the German original, the German original shall prevail. Neither the Company nor the Language Professional can accept liability for any direct, indirect, special, consequential or other losses or damages arising out of erroneous translations. Only the German version shall be deemed authoritative.

Date: June 2004

Mercedes Benz

Spare parts for trucks

Qualität – made by
dph Germany



Dichtungspartner Hamburg

Important notes

- 1.** This catalogue replaces all previous issues.
- 2.** The catalogue is protected by copyright.
The duplication of it or any part of it is prohibited.
- 3.** The supply of dph components strictly adhere to our sales and delivery agreement and are subject to our conditions of payment.
- 4.** We reserve the right to modify our components as necessary.
- 5.** The original equipment part numbers, as well as SLP, Elring-No., etc. indicated in the catalogue only serve as a cross-reference comparison with dph numbers. They must not appear on any advice notes or invoices.
- 6.** All original part numbers of engine or vehicle manufacturers in this catalogue are mentioned for comparison reasons only and should not be used in contacts with vehicle owners.
- 7.** Every effort has been made to ensure that the information in this catalogue is correct at the time of printing, but dph cannot accept any responsibility for errors which may occur.

Qualität – made by dph Germany



High quality guarantees growing success



We have always supplied our customers with high quality seals for the following sectors: Automobile, hydraulic seals, mountings and other fields all at reasonable prices and quick delivery. We can count many well-known companies throughout the world as satisfied customers.

Four strategies guarantee our success:

- First rate products with top class quality assured
- Short delivery times due to our own stock levels
- Flexibility in the procurement of all parts
- Attractive pricing policy









Fully automated electronic quality checks and manufacturing to DIN standards guarantee continuous high quality products. To your advantage and always at very fair prices.

Perfect manufacturing and continuous quality assurance

Together we are strong – this is the maxim in our group. High quality is not achieved just as a result of monitoring but of production technique. Therefore, Dichtungspartner Hamburg receives the bulk of its products from OEM suppliers and from suppliers whose quality management is certified in accordance with DIN/ISO 9000/9001.

Despite this, we still think it is necessary to check the finished products thoroughly once more within our group according to DIN/ISO 9001. Our high-grade measuring instruments are checking the radial force of oil seals, the tensile strength of elastomers, the compression set and the surface quality by means of computer-based cameras and many more. The results of the checks are registered and filed. It is good to have confidence but qualification is better!

Contents

	OEM numbers, reference list	6 – 10
	Engine gaskets and gasket sets	11 – 41
	Cylinder head gaskets & sets, cylinder liner sealing rings & kits, complete gasket sets, valve cover gaskets, oil pan gaskets & kits, manifold gaskets, valve stem seals, conversion gasket sets, repair kits compressor	
	Engine parts, fuel, exhaust and cooling system parts	42 – 60
	Oil seals, washers, o-rings, gaskets, valve guides, valves	
	Clutch, gearbox	61 – 63
	Servo cylinders, repair kits, o-rings, oil seals	
	Brake parts	64 – 68
	Diaphragms, washers, oil seals	
	Front and rear axle parts	69 – 79
	Repair kits ABS, oil seals	
	Overview of most popular oil seal types	81
	Standard terms and conditions	82 – 83

OEM numbers, reference list

OEM number	page	description
000 053 35 58	24	Valve stem seal
000 094 25 80	52	O-ring/seal ring – engine
000 094 26 80	52	O-ring/seal ring – engine
000 184 31 80	49	O-ring/seal ring – engine/fuel/oil filter
000 184 65 80	46	O-ring/seal ring – engine/fuel/oil filter
000 184 65 80	51	O-ring/seal ring – engine/fuel/oil filter
000 267 17 15	62	Transmission
000 290 06 67	61	Repair kit clutch servo
000 290 32 67	61	Repair kit clutch servo
000 295 00 18	61	Clutch servo cylinder
000 421 20 86	64	Diaphragm/brake part
000 421 29 86	64	Diaphragm/brake part
000 423 12 86	64	Diaphragm/brake part
000 431 07 28	65	Diaphragm/brake part
000 477 23 80	48	O-ring/seal ring – engine/fuel/oil filter
000 477 31 80	48	O-ring/seal ring – engine/fuel/oil filter
000 477 33 80	51	O-ring/seal ring – engine
000 477 35 80	48	O-ring/seal ring – engine/fuel/oil filter
000 586 18 26	62	Transmission
000 997 00 40	51	O-ring/seal ring – engine
000 997 11 47	62	Transmission oil seal
000 997 40 46	70	Oil seal rear axle
000 997 53 48	44	O-ring/seal ring
000 997 54 46	70	Oil seal rear axle
000 997 64 47	73	Oil seal for front axle
000 997 74 46	69	Oil seal rear axle
000 997 96 41	67	Oil seal crankshaft
001 295 67 07	61	Clutch servo cylinder
001 997 05 47	74	Oil seal for front axle
001 997 06 46	73	Oil seal for front axle
001 997 41 41	68	Oil seal crankshaft
002 997 18 47	74	Oil seal for front axle
002 997 19 47	74	Oil seal for front axle
002 997 20 47	74	Oil seal for front axle
002 997 32 47	71	Oil seal rear axle
002 997 40 46	70	Oil seal rear axle
002 997 64 46	73	Oil seal for front axle
003 997 00 40	63	Transmission oil seal
003 997 07 47	59	Oil seal crankshaft
003 997 13 47	59	Oil seal crankshaft
003 997 45 46	73	Oil seal for front axle
003 997 45 47	67	Oil seal crankshaft
003 997 48 46	72	Oil seal rear axle
003 997 66 47	72	Oil seal rear axle
003 997 67 46	67	Oil seal crankshaft
003 997 98 46	63	Transmission oil seal
004 997 17 47	74	Oil seal for front axle
004 997 18 47	74	Oil seal for front axle
004 997 59 47	74	Oil seal for front axle
004 997 77 45	69	Oil seal rear axle
004 997 93 47	67	Oil seal crankshaft
005 997 03 46	70	Oil seal rear axle
005 997 44 46	70	Oil seal rear axle
005 997 45 47	74	Oil seal for front axle
005 997 51 46	59	Oil seal crankshaft

OEM number	page	description
005 997 84 47	72	Oil seal rear axle
006 997 05 46	70	Oil seal rear axle
006 997 13 46	74	Oil seal for front axle
006 997 16 47	59	Oil seal crankshaft
006 997 21 47	70	Oil seal rear axle
006 997 23 47	59	Oil seal crankshaft
006 997 25 48	47	O-ring/seal ring – engine/fuel/oil filter
006 997 31 47	74	Oil seal for front axle
006 997 48 48	52	O-ring/seal ring – engine
006 997 49 46	62	Transmission oil seal
006 997 49 48	51	O-ring/seal ring – engine
006 997 85 47	66	Oil seal crankshaft
006 997 93 46	69	Oil seal rear axle
007 997 04 46	70	Oil seal rear axle
007 997 34 48	51	O-ring/seal ring – engine
007 997 36 46	73	Oil seal for front axle
007603 006101	45	Sealing washer, copper/variou
007603 006106	45	Sealing washer, copper/variou
007603 008100	45	Sealing washer, copper/variou
007603 008101	45	Sealing washer, copper/variou
007603 008103	45	Sealing washer, copper/variou
007603 008105	45	Sealing washer, copper/variou
007603 008109	45	Sealing washer, copper/variou
007603 010103	45	Sealing washer, copper/variou
007603 012110	45	Sealing washer, copper/variou
007603 012111	45	Sealing washer, copper/variou
007603 012113	45	Sealing washer, copper/variou
007603 014102	45	Sealing washer, copper/variou
007603 014106	44	Washer – engine
007603 016102	46	Sealing washer, copper/variou
007603 016103	45	Sealing washer, copper/variou
007603 016105	45	Sealing washer, copper/variou
007603 016401	45	Sealing washer, copper/variou
007603 017102	45	Sealing washer, copper/variou
007603 018100	46	Sealing washer, copper/variou
007603 018101	45	Sealing washer, copper/variou
007603 020100	46	Sealing washer, copper/variou
007603 020103	45	Sealing washer, copper/variou
007603 022100	46	Sealing washer, copper/variou
007603 022102	45	Sealing washer, copper/variou
007603 022104	46	Sealing washer, copper/variou
007603 024105	46	Sealing washer, copper/variou
007603 024106	65	Washer/rear axle
007603 026100	46	Sealing washer, copper/variou
007603 026101	44	Washer – engine
007603 026104	44	Washer – engine
007603 026106	46	Sealing washer, copper/variou
007603 026109	42	Washer – engine
007603 026305	44	Washer – engine
007603 027101	46	Sealing washer, copper/variou
007603 045100	65	Washer/rear axle
007603 22103	45	Sealing washer, copper/variou
008 997 60 46	69	Oil seal rear axle
008 997 61 45	51	O-ring/seal ring – engine
008 997 61 46	70	Oil seal rear axle

OEM number	page	description
008 997 62 46	69	Oil seal rear axle
008 997 70 45	50	O-ring/seal ring – engine/fuel/oil filter
008 997 73 46	62	Transmission oil seal
009 997 00 46	72	Oil seal rear axle
009 997 03 46	70	Oil seal rear axle
009 997 34 47	59	Oil seal crankshaft
009 997 51 46	67	Oil seal crankshaft
009 997 67 47	75	Oil seal front & rear axle
009 997 77 47	65	Oil seal crankshaft
009 997 77 47	66	Oil seal crankshaft
009 997 88 48	24	Cylinder liner sealing ring
009 997 94 47	66	Oil seal crankshaft
010 997 00 46	72	Oil seal rear axle
010 997 30 46	74	Oil seal for front axle
010 997 31 46	75	Oil seal for front axle
010 997 78 47	69	Oil seal rear axle
010 997 79 47	69	Oil seal rear axle
010 997 81 47	70	Oil seal rear axle
010 997 84 47	69	Oil seal rear axle
011 997 00 46	72	Oil seal rear axle
011 997 01 46	71	Oil seal rear axle
011 997 12 46	71	Oil seal rear axle
011 997 13 46	59	Oil seal crankshaft
011 997 16 46	72	Oil seal rear axle
011 997 17 46	75	Oil seal for front axle
011 997 18 46	74	Oil seal for front axle
011 997 18 46	74	Oil seal for front axle
011 997 22 46	62	Transmission oil seal
011 997 23 46	72	Oil seal rear axle
011 997 26 46	75	Oil seal front & rear axle
011 997 31 46	71	Oil seal rear axle
011 997 36 46	75	Oil seal front & rear axle
011 997 44 46	72	Oil seal rear axle
011 997 52 47	71	Oil seal rear axle
011 997 54 46	74	Oil seal for front axle
011 997 57 47	67	Oil seal crankshaft
011 997 71 47	73	Oil seal for front axle
011 997 72 47	73	Oil seal for front axle
012 997 12 48	24	Cylinder liner sealing ring
012 997 19 47	74	Oil seal for front axle
012 997 20 47	75	Oil seal for front axle
012 997 71 48	24	Cylinder liner sealing ring
012 997 74 47	59	Oil seal crankshaft
012 997 91 47	73	Oil seal for front axle
013 997 14 47	60	Oil seal crankshaft
013 997 59 47	71	Oil seal rear axle
013 997 94 47	71	Oil seal rear axle
013 997 96 48	51	O-ring/seal ring – engine
014 997 13 47	60	Oil seal crankshaft
014 997 16 47	68	Oil seal crankshaft
014 997 46 47	59	Oil seal crankshaft
014 997 46 48	60	Oil seal crankshaft
015 997 49 47	71	Oil seal rear axle
015 997 56 47	70	Oil seal rear axle
015 997 90 48	25	Cylinder liner sealing ring

OEM number	page	description
015 997 91 48	25	Cylinder liner sealing ring
015 997 93 47	70	Oil seal rear axle
016 997 08 47	60	Oil seal crankshaft
016 997 56 47	72	Oil seal rear axle
016 997 82 48	44	O-ring/seal ring
018 997 33 47	74	Oil seal for front axle
020 997 05 47	71	Oil seal rear axle
021 997 69 47	74	Oil seal for front axle
022 997 34 47	73	Oil seal for front axle
024 997 48 47	75	Oil seal trailer
0634 314 018	63	Transmission seal ring
0634 314 019	63	Transmission seal ring
0634 314 020	63	Transmission seal ring
0750 112 066	63	Transmission seal ring
1295 298 915	76	Gasket set for steering
1295 298 917	76	Gasket set for steering
303 997 06 47	69	Oil seal rear axle
304 997 04 47	72	Oil seal rear axle
304 997 11 47	72	Oil seal rear axle
304 997 17 47	72	Oil seal rear axle
312 053 02 30	58	Valve guide
314 010 02 80	35	Oil pan gasket kit
314 010 02 80	35	Oil pan gasket kit
314 010 60 20	14	Cylinder head gasket set
314 016 03 21	29	Valve cover gasket
314 016 07 20	11	Cylinder head gasket
314 142 03 80	36	Manifold gasket
315 030 00 80	59	Oil seal crankshaft
317 333 11 64	73	Gasket for front axle
317 997 00 47	72	Oil seal rear axle
327 016 08 20	12	Cylinder head gasket
335 997 00 47	72	Oil seal rear axle
345 142 00 80	37	Manifold gasket
346 016 02 21	30	Valve cover gasket
346 016 03 20	12	Cylinder head gasket
346 017 01 60	57	Gasket/engine
346 017 02 60	51	O-ring/seal ring – engine
346 141 01 80	36	Manifold gasket
346 142 00 60	37	Manifold gasket
346 334 00 80S	78	Repair kit for ABS rear axle
346 356 01 27	75	Gasket for rear axle
346 997 04 45	51	O-ring/seal ring – engine
352 010 04 80	36	Oil pan gasket kit
352 010 08 80	35	Oil pan gasket kit
352 010 12 80	36	Oil pan gasket kit
352 010 12 80 (kork)	36	Oil pan gasket kit
352 010 26 21	17	Cylinder head gasket set
352 010 27 21	17	Cylinder head gasket set
352 015 01 60	53	Gasket
352 015 05 22	29	Valve cover gasket
352 016 07 20	14	Cylinder head gasket
352 016 09 21	29	Valve cover gasket
352 053 02 96	20	Valve stem seal
352 053 16 30	58	Valve guide
352 053 22 29	58	Valve guide

OEM number	page	description
352 053 37 30	58	Valve guide
352 076 02 80	56	Gasket/engine
352 078 00 80	44	Washer – engine
352 142 04 80	37	Manifold gasket
352 997 05 40	56	Gasket/engine
353 010 48 08	19	Conversion gasket set
355 010 00 27	35	Oil pan gasket kit
355 010 12 20	14	Cylinder head gasket set
355 010 55 08	17	Conversion gasket set
355 016 00 21	30	Valve cover gasket
355 016 04 20	12	Cylinder head gasket
355 141 02 80	36	Manifold gasket
355 142 01 80	37	Manifold gasket
355 142 04 80	37	Manifold gasket
355 188 00 80	57	Gasket/engine
355 203 00 80	57	Gasket/engine
355 356 01 73 S	79	Repair kit for ABS front axle
355 586 03 90	28	Full set
355 997 00 49	57	Gasket/engine
357 333 00 64	44	Washer – engine
360 010 03 44	27	Gasket set compl. engine overhaul incl...
360 010 33 20	14	Cylinder head gasket set
360 014 03 22	33	Oil pan gasket
360 016 02 21	29	Valve cover gasket
360 053 00 30	58	Valve guide
360 053 00 29	59	Valve guide
360 586 18 46	75	Gasket for rear axle
360 997 92 45	51	O-ring/seal ring – engine
364 010 01 80	33	Oil pan gasket
364 010 01 80	36	Oil pan gasket kit
364 010 22 08	19	Conversion gasket set
364 010 40 20	15	Cylinder head gasket set
364 016 00 21	30	Valve cover gasket
364 016 01 21	30	Valve cover gasket
364 184 03 80	33	Valve cover gasket
366 010 44 08	17	Conversion gasket set
366 010 61 20	15	Cylinder head gasket set
366 015 00 60	30	Valve cover gasket
366 015 00 60	53	Gasket
366 016 00 21	30	Valve cover gasket
366 016 03 21	30	Valve cover gasket
366 016 06 20	11	Cylinder head gasket
366 053 01 58	21	Valve stem seal
366 141 05 80	37	Manifold gasket
366 141 07 81	37	Manifold gasket
366 142 04 80	37	Manifold gasket
366 188 08 80	57	Gasket/engine
366 586 54 46	76	Gasket set for steering
383 350 00 68	78	Repair kit for ABS rear axle
385 350 00 68	78	Repair kit for ABS rear axle
385 350 02 68	79	Repair kit for ABS rear axle
387 460 26 01	76	Gasket set for steering
387 586 03 46	76	Gasket set for steering
402 130 02 20	41	Repair kit compressor
403 015 01 60	32	Valve cover gasket



OEM number	page	description
403 016 00 61	57	Gasket/engine
403 016 01 21	32	Valve cover gasket
403 016 03 21	31	Valve cover gasket
403 053 01 96	22	Valve stem seal
403 074 00 59	56	Gasket/engine
403 142 03 80	38	Manifold gasket
403 997 01 46	60	Oil seal crankshaft
405 014 02 22	34	Oil pan gasket kit
407 010 23 08	18	Conversion gasket set
407 131 05 80	57	Gasket/engine
421 010 04 08	18	Conversion gasket set
422 010 06 08	18	Conversion gasket set
422 053 01 96	23	Valve stem seal
422 053 04 30	58	Valve guide
422 142 00 80	41	Manifold gasket
422 144 02 80	51	O-ring/seal ring – engine
422 997 00 40	51	O-ring/seal ring – engine
423 010 03 20	16	Cylinder head gasket set
423 010 08 80	16	Cylinder head gasket set
423 010 48 33	53	Gasket set
423 011 02 59	24	Cylinder liner sealing ring
423 050 00 26	58	Valve
423 050 04 28	58	Valve
441 014 00 22	33	Oil pan gasket
442 011 00 59	54	Gasket/engine
442 011 00 80	54	Gasket/engine
442 011 02 59	54	Gasket/engine
442 014 02 22	34	Oil pan gasket kit
442 015 00 60	32	Valve cover gasket
442 016 01 21	31	Valve cover gasket
442 016 03 20	12	Cylinder head gasket
442 016 04 20	12	Cylinder head gasket
442 016 06 21	31	Valve cover gasket
442 018 00 80	56	Gasket/engine
442 074 00 59	56	Gasket/engine
442 098 09 80	54	Gasket/engine
442 098 10 80	54	Gasket/engine
442 131 00 80	54	Gasket/engine
442 131 01 80	55	Gasket/engine
442 131 09 80	55	Gasket/engine
442 141 04 80	55	Gasket/engine
442 141 07 80	40	Manifold gasket
442 141 09 80	55	Gasket/engine
442 141 17 80	39	Manifold gasket
442 184 04 80	55	Gasket/engine
442 184 05 80	55	Gasket/engine
442 187 00 80	55	Gasket/engine
442 187 01 80	56	Gasket/engine
442 188 05 80	56	Gasket/engine
442 201 10 80	56	Gasket/engine
442 492 00 80	52	Gaske t
443 014 00 22	34	Oil pan gasket kit
444 010 01 20	15	Cylinder head gasket set
447 014 00 22	34	Oil pan gasket kit
457 010 62 20	17	Cylinder head gasket set

Engine gaskets and gasket sets

Cylinder head gasket

dph-no.	OEM-no.	application
98588 / 98589	314 016 07 20/ 314 016 07 20 graphite	 <p>OM 314 up to engine 492711 from engine 492712 All engine types 40-63kW Diesel cyl. 97dia.</p> <p>MB Trac 65, 70 / 440 MB Trac 700, 800, 900 / 440 40-63kW Diesel cyl. 97dia.</p> <p>OM 364 906/907/912/918/919/921 OM 364 A 950/952/957/958</p>
		<p>OM 364 LA 981/986 63-100kW Diesel cyl. 97,5 dia.</p> <p>MB Trac 700, 800, 900 / 440 50-66kW Diesel cyl. 97,5 dia.</p> <p>MB Trac 65, 70 / 440 700, 800, 900 / 440 OM 314 up to engine 492711 MB 314: 956/957 OM 314 A up to engine 492711 MB 314: 970 48-63 kW Diesel cyl. 97 dia.</p> <p>MB Trac 65, 70 / 440 700, 800, 900 / 440 OM 314 from engine 492712 MB: 314: 956/957 OM 314 from engine 492712 MB 314: 970 48-63kW Diesel cy. 97 dia</p> <p>MB Trac 700, 800, 900 / 440 OM 364: 908, 909 OM 364: 951 50-66kW Diesel cyl. 97,5 dia.</p>
81134	366 016 06 20	 <p>OM 322 910-919/970/971 Diesel cyl. 97 dia.</p> <p>OM 352 up to engine 760548 OM 352 A from engine 760548 352 all, 353 all 74-96 kW, Diesel cyl. 97 dia. 96-127kW, Diesel dyl. 97 dia. OM 352 A up to engine 760548 OM 352 A from engine 760549</p> <p>OM 362 LA 906/909/910 141kW Diesel cyl. 97 dia.</p> <p>OM 366 M.B. 356: 901/902/904/905/908/910/ 911/913 M.B. 366: 905-907/909/910/914/917/919/930/ 932/933/936/938/940 OM 366 A M.B. 356: 940/943/944/946/948/ 951/953 MB. 366: 941-943/945/946/951-953/957/962/ 965/967-971/973 OM 366 LA M.B. 356: 984/987 M.B. 366: 980/981/983/988/990/993/995-997 95-150kW Diesel cyl. 97,5</p>
		<p>OM 366 M.B. 346: 903/909 M.B. 366: 918/931/937 OM 366 A M.B. 356: 941/945/947/952 M.B. 366: 944/966/974/976/978/979 OM 366LA M.B. 356: 985/986/990/992/994/995 M.B. 366: 992/994 95-150kW Diesel cyl. 97,5 OM 366 LA M.B. 356: 979/983/989/991/996/999 M.B. 366: 901/999 155-155kW Diesel cyl. 97,5 dia.</p> <p>MB Trac 1000 / 441 1100 / 442, 443 OM 352 up to engine 760548 M.B. 353: 936/949/985 70-81kW Diesel cyl. 97 dia.</p> <p>MB Trac 1000 / 441 1100 / 442, 443 OM 352 from engine 760549 M.B. 353: 936/949/985 70-81kW Diesel cyl. 97 dia.</p> <p>MB Trac 1000 / 441, 162 1100 / 441, 163 1300 / 443, 163 1400 / 443, 164 1600 / 443, 166 OM 366 M.B. 366: 908/912 OM 366 A M.B. 366: 954/958/977 74-115kW Diesel cyl. 97,5 dia.</p> <p>Unimog U900, U1000, U1150, U1200, U1250, U1350, U1400, U1450, U1550, U1600, U1650, U1700, U1750, U2100, U2150</p>



Cylinder head gasket

dph-no.	OEM-no.	application
98554	327 016 08 20	OM 327 914-917/919/921-946 Diesel cyl. 115 dia 2 pcs required
96520 110017	346 016 03 20 with silicone 346 016 03 20 without silicone	 OM 346 Up to engine 027399 910-919/940-947/951-953 154kW Diesel 128 cyl. Dia. 6 pcs required
96521	355 016 04 20	 2 pcs required OM 346 All engine types 154kW Diesel cyl. 128 OM 355, OM 355A/LA All engine types 136-207kW Diesel cyl. 128 di
84756 109284	442 016 03 20 / 442 016 04 20 new type	 OM 401 M.B. 401: 900/901/905-909/912-916/918/919/ 921-928 6 cyl. V-motor 129-144kW Diesel cyl. 125 dia 6 pcs required OM 401 A 917 6 cyl. V-motor 188kW Diesel cyl. 125 dia. 6 pcs required OM 401 LA Euro I 970/972-974/977-981 6 cyl. V-motor 213-230kW Diesel cyl. 125 dia 6 pcs required OM 403 900/905/906/910/911/915-919/930-935 10 cyl. V-motor 184-261kW Diesel cyl. 125 dia 10 pcs. Required OM 404, OM 404 A 900/901 12 cyl. V-motor Diesel cyl. 125 dia. 12 pcs required OM 407 / OM407 A, LA, H, HA 900/901/905/907-911/913-920/925/951/955 6 cyl. In-line engine 132-206kW Diesel cyl. 125 dia. 6 pcs required
		OM 409 901 5 cyl. Diesel in-line engine cyl. 125 dia. 5 pcs required OM 421 900/905-908/910 OM 421 A/LA 901/951 6 cyl. V-motor 159-184kW Diesel cyl. 128 dia. 6 pcs required OM 423 900/905-909 OM 423 A/LA 901/950 10 cyl. V-motor 261-368kW Diesel cyl. 128 dia 10 pcs required OM 424, OM 424 A/LA 900/901 12 cyl. V-motor Diesel cyl. 128 dia. 12 pcs required OM 427, OM 427 H 900/901/905/910/911 OM 427A / LA OM 427 HA 902/903/950/951/952 6 cylinder in-line engine 150-206kW Diesel cyl. 128 dia. 6 pcs required OM 441 900/905-909/911-921/923-937 150-165kW OM 441 Euro I 900/922/932/933 151kW 6 cyl. V-motor Diesel cyl. 128/130 dia. 6 pcs required



Cylinder head gasket

dph-no.	OEM-no.	application
		<p>OM 441 A / OM 441 LA 901/950/951/953/960-962/985 200-250kW OM 441 A Euro I, OM 441 LA Euro I 901/980-983/986-990/992/994 250kW 6 cyl. V-motor Diesel cyl. 128/130 dia. 6 pcs required</p> <p>OM 442 900/905-911/914-930/932-935/939 191-218kW OM 442 Euro I 900/931 195kW 8 cyl. V-motor Diesel cyl. 128/130 dia. 8 pcs required</p> <p>OM 442 A / OM 442 LA 901/941-946/950-955/957-968/976/978/980/ 982/983/985/989/992-994 269-362kW OM 442 A Euro I / OM 442 LA Euro I 940-942/972-973 250-370kW 8 cyl. V-motor Diesel cyl. 128/130 dia. 8 pcs required</p> <p>OM 442 900/905 271kW OM 443A, OM 443 LA 901/940/980 340-412kW OM 443 LA Euro I 901-504 10 cyl. V-motor Diesel cyl. 128 dia. 10 pcs required</p>
		<p>OM 444 A / OM 444 LA 901 12 cyl. V-motor Diesel cyl. 128 dia. 12 pcs required</p> <p>OM 447 900 OM 447 Euro I 900-004 OM 447 H 901/905-908, 910-913 150-184kW OM 447 H Euro I 901-04/914 157kW OM 447 A, OM 447 LA 902 OM 447 A Euro I, OM 447 LA Euro I 902-404/902-504 OM 447 HA, OM 447 HLA 903/950-953 206kW</p> <p>OM 447 HA Euro I / OM 447 HLA Euro I 903-604/903-704/956/957/959/981/ 982/984/986 184-220kW 6 cyl. In-line engine Diesel cyl. 128 dia. 6 pcs required</p> <p>OM 449 HLA 155-184 kW, 5 cyl. Diesel dia. 128</p> <p>OM 449 A/LA 184-235 kW, 5 cyl. Diesel dia. 128</p>
95489	422 016 04 20 version copper	 <p>OM 421 900/905-908/910 OM 421 A/LA 901/951 6 cyl. V-motor 159-184kW Diesel cyl. 128 dia. 6 pcs required</p> <p>OM 422 900/905-915/917-923 8 cyl. V-motor, 8 pcs required 184/206kW Diesel cyl. 128 dia. OM 422 900/905-915/917-923</p>
		<p>OM 422 A/LA 901/951-959-963 8 cyl. V-motor 184-276kW Diesel cyl. 128 dia. 8 pcs required</p> <p>OM 423 900/905-909 OM 423 A/LA 901/950 10 cyl. V-motor 261-368kW Diesel cyl. 128 dia 10 pcs required</p> <p>OM 424, OM 424 A/LA 900/901 12 cyl. V-motor Diesel cyl. 128 dia. 12 pcs required</p> <p>OM 427, OM 427 H 900/901/905/910/911 OM 427A / LA OM 427 HA 902/903/950/951/952 6 cylinder in-line engine 150-206kW Diesel cyl. 128 dia. 6 pcs required</p>
98608	541 016 04 20	
109803	541 016 11 20	
		<p>OM 501 LA / OM 501 LA IMO Actros M.B: 521: 940 M.B: 541: 920-928 M.B: 941: 910/920/929/930/940/960/970/990 6 cyl. V-motor Diesel 230-315kW 6 pcs required OM 502 LA Actros 8 cyl. V-engine 350-420 kw Diesel 8 pcs required</p>

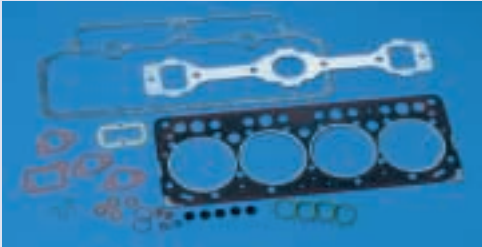

Cylinder head gasket

dph-no.	OEM-no.	application
98591	352 016 07 20	 OM 352
98592	352 016 07 20 graphite	 OM 352

Cylinder head gasket set

dph-no.	OEM-no.	application
94614	314 010 60 20	 <p>OM 314 Up to engine -492711 From engine 492711 All engine types 40-63kW Diesel cyl. 97dia.</p> <p>MB Trac 65, 70 / 440 MB Trac 700, 800, 900 / 440 40-63kW Diesel cyl. 97dia.</p> <p>MB Trac 65, 70 / 440 700, 800, 900 / 440 OM 314 up to engine 492711 MB 314: 956/957 OM 314 A up to engine 492711 MB 314: 970 48-63 kW Diesel cyl. 97 dia.</p> <p>MB Trac 65, 70 / 440 700, 800, 900 / 440 OM 314 from engine 492712 MB: 314: 956/957 OM 314 from engine 492712 MB 314: 970 48-63kW Diesel cy. 97 dia</p>
97284 / 94734	355 010 12 20 + 352 053 02 96 (24 pcs required)	 <p>OM 346 All engine types 154kW Diesel cyl. 128</p> <p>OM 355, OM 355A/LA All engine types 136-207kW Diesel cyl. 128 dia</p>
95823	360 010 33 20	<p>OM 360 910/914-918/930/931/933/935-944/946/948-952/ 960-973/975/979/980/981/983 125-141kW Diesel cyl. 115 dia.</p> <p>OM 360 A 154kW Diesel cyl. 115 dia.</p> <p>OM 360 H 911/912/934/947/954-956/959/974/976-978 horizontal engine 125/141kW Diesel cyl. 115 dia.</p>

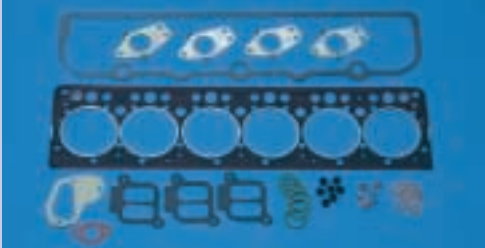

Cylinder head gasket set

dph-no.	OEM-no.	application
94615	364 010 40 20	 <p>OM 364 LA 981/986/ 63-100 kW Diesel cyl. 97,5 dia</p> <p>MB Trac 700, 800, 900 / 440 OM 364: 908, 909 OM 364: 951 50-66kW Diesel cyl. 97,5 dia.</p> <p>OM 364 906/907/912/918/921 OM 364 A 950/952/957/958</p>
94613	366 010 61 20	 <p>OM 366 A M.B. 356: 941/945/947/952 M.B. 366: 944/966/974/976/978/979 OM 366LA M.B. 356: 985/986/990/992/994/995 M.B. 366: 992/994 95-150kW Diesel cyl. 97,5</p> <p>MB Trac 1000 /441,162 1100 /441,163 1300 /443,163 1400 /443,164 1600 /443,166 OM 366 M.B. 366: 908/912 OM 366 A M.B. 366: 954/958/977 74-115kW Diesel cyl. 97,5 dia.</p> <p>OM 366 M.B. 356: 901/902/904/905/908/910/911/913 M.B. 366: 905-907/909/910/914/917/919/930/ 932/933/936/938/940 OM 366 A M.B. 356: 940/943/944/946/948/951/953 M.B. 366: 941-943/945/946/951-953/957/962/ 965/967-971/973 OM 366 LA M.B. 356: 984/987 M.B. 366: 980/981/983/988/990/993/995-997 95-150kW Diesel cyl. 97,5 OM 366 M.B. 346: 903/909 M.B. 366: 918/931/937</p> <p>Unimog U900, U1000, U1150, U1200, U1250, U1350, U1400, U1450, U1550, U1600, U1650, U1700, U1750, U2100, U2150</p>
81418 95800	444 010 01 20 444 010 01 20 with cyl. head gasket in CU	 <p>OM 401 M.B. 401: 900/901/905-909/912-916/918/919/ 921-928 6 cyl. V-motor 129-144kW Diesel cyl. 125 dia from engine 001207 OM 401 A 917 6 cyl. V-motor 188kW Diesel cyl. 125 dia. OM 401 LA Euro I 970/972-974/977-981 6 cyl. V-motor 213-230kW Diesel cyl. 125 dia</p> <p>OM 402 900/901/905-907/910-914/916/917/919/921/ 923-928 8cyl. V-motor 147-188kW Diesel cyl. 125 dia. From engine 013688</p> <p>OM 402 LA Euro I 970-973/975 8 cyl. V-motor 280kW Diesel cyl. 125 dia</p> <p>OM 403 900/905/906/910/911/915-919/930-935 10 cyl. V-motor 184-261kW Diesel cyl. 125 dia. From engine 002608</p> <p>OM 404, OM 404 A 900/901 12 cyl. V-motor Diesel cyl. 125 dia.</p> <p>OM 407 / OM407 A, LA, H, HA 900/901/905/907-911/913-920/925/ 951/955 6 cyl. In-line engine 132-206kW Diesel cyl. 125 dia. From engine 002810 M.B. 407: 900/905/ 907-911/951/955</p> <p>OM 409 901 5 cyl. Diesel in-line engine cyl. 125 dia.</p> <p>OM 421 900/905-908/910 OM 421 A/LA 901/951 6 cyl. V-motor 159-184kW Diesel cyl. 128 dia.</p>

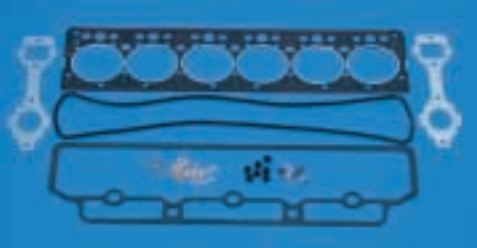

Cylinder head gasket set

dph-no.	OEM-no.	application
		<p>OM 422 900/905-915/917-923 8 cyl. V-motor 184/206kW Diesel cyl. 128 dia.</p> <p>OM 422 900/905-915/917-923</p> <p>OM 422 A/LA 901/951-959-963 8 cyl. V-motor 184-276kW Diesel cyl. 128 dia.</p> <p>OM 423 900/905-909</p> <p>OM 423 A/LA 901/950 10 cyl. V-motor 261-368kW Diesel cyl. 128 dia</p> <p>OM 424, OM 424 A/LA 900/901 12 cyl. V-motor Diesel cyl. 128 dia.</p> <p>OM 441 900/905-909/911-921/923-937 150-165kW</p> <p>OM 441 Euro I 900/922/932/933 151kW 6 cyl. V-motor Diesel cyl. 128/130 dia.</p> <p>OM 441 A / OM 441 LA 901/950/951/953/960-962/985 200-250kW</p> <p>OM 441 A Euro I, OM 441 LA Euro I 901/980-983/986-990/992/994 250kW 6 cyl. V-motor Diesel cyl. 128/130 dia.</p>
		<p>OM 442 900/905-911/914-930/932-935/939 191-218kW</p> <p>OM 442 Euro I 900/931 195kW 8 cyl. V-motor Diesel cyl. 128/130 dia.</p> <p>OM 442 A / OM 442 LA 901/941-946/950-955/957-968/976/978/980/982/ 983/985/989/992-994 269-362kW</p> <p>OM 442 A Euro I / OM 442 LA Euro I 940-942/972-973 250-370kW 8 cyl. V-motor Diesel cyl. 128/130 dia.</p> <p>OM 442 900/905 271kW</p> <p>OM 443A, OM 443 LA 901/940/980 340-412kW</p> <p>OM 443 LA Euro I 901-504 10 cyl. V-motor Diesel cyl. 128 dia.</p> <p>OM 444 A / OM 444 LA 901 12 cyl. V-motor Diesel cyl. 128 dia.</p> <p>OM 449 A/LA 184-235 kW, 5 cyl. Diesel dia. 128</p>
81830 84271	423 010 03 20 423 010 08 80	 <p>Without valve stem seals Same application as dph 81418</p>
98607	541 010 11 20	 <p>OM 501 LA / OM 501 LA IMO Actros M.B: 521: 940 M.B: 541: 920-928 M.B: 941: 910/920/929/930/940/960/970/990 6 cyl. V-motor Diesel 230-315kW, 6 pcs required</p> <p>OM 502 LA Actros 8 cyl. V-engine 350-420 kw Diesel, 8 pcs required</p>
109922	541 010 25 20	 <p>Actros</p>

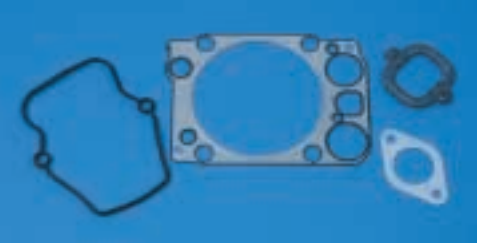

Cylinder head gasket set

dph-no.	OEM-no.	application
80277	352 010 26 21 / 352 010 27 21	 <p>MB Trac 1000 /441 1100 /442, 443 OM 352 up to engine 760548 M.B. 353: 936/949/985 70-81kW Diesel cyl. 97 dia.</p> <p>OM 352 from engine 760549 M.B. 353: 936/949/985 70-81kW Diesel cyl. 97 dia.</p>
110321	541 010 52 20	 <p>Actros MB 541</p>
110322	457 010 62 20	 <p>Actros MB 457</p>

Conversion gasket set

dph-no.	OEM-no.	application
97285	355 010 55 08	 <p>OM 355, OM 355A/LA All engine types 136-207kW Diesel cyl. 128 di</p>
94610	366 010 44 08	 <p>OM 366 M.B. 356: 901/902/904/905/908/910/911/913 M.B. 366: 905-907/909/910/914/917/919/930/ 932/933/936/938/940</p> <p>OM 366 A M.B. 356: 940/943/944/946/948/951/953 M.B. 366: 941-943/945/946/951-953/957/962/ 965/967-971/973</p> <p>OM 366 LA M.B. 356: 984/987 M.B. 366: 980/981/983/988/990/993/995-997 95-150kW Diesel cyl. 97,5</p> <p>OM 366 M.B. 346: 903/909 M.B. 366: 918/931/937</p> <p>OM 366 A M.B. 356: 941/945/947/952 M.B. 366: 944/966/974/976/978/979</p> <p>OM 366LA M.B. 356: 985/986/990/992/994/995 M.B. 366: 992/994 95-150kW Diesel cyl. 97,5 OM 366 LA M.B. 356: 979/983/989/991/996/999 M.B. 366: 901/999 155-177kW Diesel cyl. 97,5 dia.</p> <p>MB Trac 1000 /441,162 1100 /441,163 1300 /443,163 1400 /443,164 1600 /443,166 OM 366 M.B. 366: 908/912 OM 366 A M.B. 366: 954/958/977 74-115kW Diesel cyl. 97,5 dia.</p> <p>Unimog U900, U1000, U1150, U1200, U1250, U1350, U1400, U1450, U1550, U1600, U1650, U1700, U1750, U2100, U2150</p>

Conversion gasket set

dph-no.	OEM-no.	application
98337	421 010 04 08	 <p>OM 401 M.B. 401: 900/901/905-909/912-916/918/919/921-928 6 cyl. V-motor 129-144kW Diesel cyl. 125 dia</p> <p>OM 401 A 917 6 cyl. V-motor 188kW Diesel cyl. 125 dia.</p> <p>OM 401 LA Euro I 970/972-974/977-981 6 cyl. V-motor</p>
		<p>213-230kW Diesel cyl. 125 dia</p> <p>OM 421 900/905-908/910 OM 421 A/LA 901/951 6 cyl. V-motor 159-184kW Diesel cyl. 128 dia.</p> <p>OM 441 900/905-909/911-921/923-937 150-165kW OM 441 Euro I 900/922/932/933 151kW 6 cyl. V-motor Diesel cyl. 128/130 dia.</p> <p>OM 441 A / OM 441 LA 901/950/951/953/960-962/985 200-250kW OM 441 A Euro I, OM 441 LA Euro I 901/980-983/986-990/992/994 250kW 6 cyl. V-motor Diesel cyl. 128/130 dia.</p>
94584	422 010 06 08	 <p>OM 402 900/901/905-907/910-914/916/917/919/921/923-928 8cyl. V-motor 147-188kW Diesel cyl. 125 dia.</p> <p>OM 402 LA Euro I 970-973/975 8 cyl. V-motor 280kW Diesel cyl. 125 dia</p> <p>OM 422 900/905-915/917-923 8 cyl. V-motor 184/206kW Diesel cyl. 128 dia.</p>
		<p>OM 422 900/905-915/917-923 OM 422 A/LA 901/951-959-963 8 cyl. V-motor 184-276kW Diesel cyl. 128 dia.</p> <p>OM 442 900/905-911/914-930/932-935/939 191-218kW OM 442 Euro I 900/931 195kW 8 cyl. V-motor Diesel cyl. 128/130 dia.</p> <p>OM 442 A / OM 442 LA 901/941-946/950-955/957-968/976/ 978/980/982/983/985/989/992-994 269-362kW OM 442 A Euro I / OM 442 LA Euro I 940-942/972-973 250-370kW 8 cyl. V-motor Diesel cyl. 128/130 dia.</p>
94609	407 010 23 08	 <p>OM 407 / OM407 A, LA, H, HA 900/901/905/907-911/913-920/925/951/955 6 cyl. In-line engine 132-206kW Diesel cyl. 125 dia.</p>
98699	541 010 02 05	<p>OM 501 LA / OM 501 LA IMO Actros M.B: 521: 940 M.B: 541: 920-928 M.B: 941: 910/920/929/930/940/960/970/990 6 cyl. V-motor Diesel 230-315kW MB: 521: 940 MB: 541: 928 MB: 941: 910/920/929/940/960/970/990</p>
		<p>MB 541: 920/922/923/925 Up to engine 0120090</p> <p>OM 502 LA Actros 8 cyl. V-engine 350-420 kw Diesel 8 pcs required up to engine 012090</p>

Conversion gasket set

dph-no.	OEM-no.	application
98701	541 010 05 05	OM 501 LA / OM 501 LA IMO Actros M.B: 521: 940 M.B: 541: 920-928 M.B: 941: 910/920/929/930/940/960/970/990 6 cyl. V-motor Diesel 230-315kW MB: 541: 921/924/926/927 MB: 541: 920/922/923/925 From engine 012091
94611	364 010 22 08	 <p> MB Trac 65, 70 / 440 MB Trac 700, 800, 900 / 440 40-63kW Diesel cyl. 97dia. </p> <p> MB Trac 700, 800, 900 / 440 50-66kW Diesel cyl. 97,5 dia. </p> <p> MB Trac 65, 70 / 440 700, 800, 900 / 440 OM 314 from engine 492712 MB: 314: 956/957 OM 314 from engine 492712 MB 314: 970 48-63kW Diesel cy. 97 dia </p> <p> MB Trac 700, 800, 900 / 440 OM 364: 908, 909 OM 364: 951 50-66kW Diesel cyl. 97,5 dia. </p> <p> OM 314 up to engine 492711 from engine 492712 All engine types 40-63kW Diesel cyl. 97dia. </p> <p> OM 364 906/907/912/918/919/921 OM 364 A 950/952/957/958 OM 364 LA 981/986 63-100kW Diesel cyl. 97,5 dia. </p>
94612	353 010 48 08	 <p> OM 352 Up to engine 760548 352 all, 353 all; 74-96kW OM 352 A Up to engine 760549 352 all, 353 all; 96-127kW Diesel cyl. 97 dia OM 362 LA 906/909/910 141kW Diesel cyl. 97 dia. </p>

Valve stem seal

dph-no. OEM-no. application

94734 352 053 02 96



Size: 8,10 x 14,69 x 19,19 mm

OM 314 –motor 492711

All engine types 40-63kW
Diesel cyl. 97dia.
4 pcs. Required
up to engine 467999

OM 346

Up to engine 027399
910-919/940-947/951-953
154kW
Diesel 128 cyl. Dia.

All engine types OM 346
24 pcs required (input/output)

OM 352 up to engine 760548

OM 352 from engine 760548 (up to engine 794938)
352 all, 353 all
74-96 kW Diesel cyl. 97 dia.

OM 352 A up to engine 760548

OM 352 A from engine 760549 (up to engine 794938)
352 all, 353 all
96-127kW Diesel cyl. 97 dia.

6 pcs required

OM 355, OM 355A/LA

All engine types
136-207kW Diesel cyl. 128 dia
input/output 24 pcs required

OM 362 LA

906/909/910
141kW Diesel cyl. 97 dia.
Up to engine 794938
6 pcs required

MB Trac 65, 70 /440

MB Trac 700, 800, 900 /440
40-63kW
Diesel cyl. 97dia.
Up to engine 467999
4 pcs required

MB Trac

65, 70 /440
700, 800, 900 /440
OM 314 up to engine 492711
MB 314: 956/957

OM 314 A up to engine 492711

MB 314: 970
48-64 kW Diesel cyl. 97 dia.
4 pcs required / input
up to engine 467999

MB Trac

1000 /441
1100 /442, 443
OM 352 up to engine 760548
M.B. 353: 936/949/985
70-81kW Diesel cyl. 97 dia.
6 pcs required

MB Trac

1000 /441
1100 /442, 443
OM 352 from engine 760549
M.B. 353: 936/949/985
70-81kW Diesel cyl. 97 dia.
6 pcs required, up to engine 794938

Valve stem seal

dph-no.	OEM-no.	application
82483	366 053 0158	<p>OM 314 Up to engine -492711 From engine 492711 All engine types 40-63kW Diesel cyl. 97dia. 4 pcs required up to engine 468000</p> <p>OM 352 from engine 760548 (from engine 794938) 352 all, 353 all, 6 pcs 74-96kW Diesel cyl. 97 dia OM 352 A from engine 760549 (from engine 794939) 352 all, 353 all, 6 pcs. 96-127kW, Diesel cyl. 97 dia</p> <p>OM 362 LA 906/909/910 141kW Diesel cyl. 97 dia. From engine 794939 6 pcs required</p> <p>OM 364 906/907/912/918/919/921 OM 364 A 950/952/957/958 OM 364 LA 981/986 63-100kW Diesel cyl. 97,5 dia. 4 pcs required</p> <p>OM 366 M.B. 356: 901/902/904/905/908/910/911/913 M.B. 366: 905-907/909/910/914/917/919/930/ 932/933/936/938/940 OM 366 A M.B. 356: 940/943/944/946/948/951/953 M.B. 366: 941-943/945/946/951-953/957/962/ 965/967-971/973 OM 366 LA M.B. 356: 984/987 M.B. 366: 980/981/983/988/990/993/995-997 95-150kW Diesel cyl. 97,5 OM 366 M.B. 346: 903/909 M.B. 366: 918/931/937 OM 366 A M.B. 356: 941/945/947/952 M.B. 366: 944/966/974/976/978/979 OM 366LA M.B. 356: 985/986/990/992/994/995 M.B.: 366: 992/994 95-150kW Diesel cyl. 97,5</p> <p>OM 366 LA M.B. 356: 979/983/989/991/996/999 M.B. 366: 901/999 6 pcs required</p>
		<p>MB Trac 65, 70 /440 MB Trac 700, 800, 900 /440 40-63kW Diesel cyl. 97dia. from engine 468000 4 pcs required</p> <p>MB Trac 65, 70 /440 700, 800, 900 /440 OM 314 up to engine 492711 MB 314: 956/957 OM 314 A up to engine 492711 MB 314: 970 48-64 kW Diesel cyl. 97 dia. 4 pcs required / output from engine 468000</p> <p>MB Trac 65, 70 / 440 700, 800, 900 / 440 OM 314 from engine 492712 MB: 314: 956/957 OM 314 from engine 492712 MB 314: 970 48-63kW Diesel cy. 97 dia 4 pcs required</p> <p>MB Trac 700, 800, 900 / 440 OM 364: 908, 909 OM 364: 951 50-66kW Diesel cyl. 97,5 dia. 4 pcs required</p> <p>MB Trac 1000 /441 1100 /442, 443 OM 352 from engine 760549 M.B. 353: 936/949/985 70-81kW Diesel cyl. 97 dia. 6 pcs required, from engine 794939</p> <p>MB Trac 1000 /441,162 1100 /441,163 1300 /443,163 1400 /443,164 1600 /443,166 OM 366 M.B. 366: 908/912 OM 366 A M.B.: 366: 954/958/977 74-115kW Diesel cyl. 97,5 dia.</p> <p>Unimog U900, U1000, U1150, U1200, U1250, U1350, U1400, U1450, U1550, U1600, U1650, U1700, U1750, U2100, U2150 6 pcs required</p>

Valve stem seal

dph-no.	OEM-no.	application
94733	403 053 01 96	 <p>Material: ACM</p> <p>OM 401 M.B. 401: 900/901/905-909/912-916/918/919/921-928 6 cyl. V-motor, 12 pcs. required 129-144kW Diesel cyl. 125 dia from engine 001207</p> <p>OM 401 A 917 6 cyl. V-motor, 12 pcs. required 188kW Diesel cyl. 125 dia.</p> <p>OM 401 LA Euro I 970/972-974/977-981 6 cyl. V-motor, 12 pcs required 213-230kW Diesel cyl. 125 dia</p> <p>OM 402 900/901/905-907/910-914/916/917/919/921/923-928 8cyl. V-motor 147-188kW Diesel cyl. 125 dia 16 pcs required</p> <p>OM 403 900/905/906/910/911/915-919/930-935 10 cyl. V-motor 184-261kW Diesel cyl. 125 dia 20 pcs. Required</p> <p>OM 404, OM 404 A 900/901 12 cyl. V-motor Diesel cyl. 125 dia. 24 pcs required</p> <p>OM 407 / OM407 A, LA, H, HA 900/901/905/907-911/913-920/925/951/955 6 cyl. In-line engine 132-206kW Diesel cyl. 125 dia. 12 pcs required</p> <p>OM 409 901 5 cyl. Diesel in-line engine cyl. 125 dia. 10 pcs required</p> <p>OM 421 900/905-908/910 OM 421 A/LA 901/951 6 cyl. V-motor 159-184kW Diesel cyl. 128 dia. 12 pcs required</p> <p>OM 422 900/905-915/917-923 8 cyl. V-motor 184/206kW Diesel cyl. 128 dia.</p> <p>OM 422 900/905-915/917-923 OM 422 A/LA 901/951-959-963 8 cyl. V-motor 184-276kW Diesel cyl. 128 dia. 16 pcs required</p> <p>OM 423 900/905-909 OM 423 A/LA 901/950 10 cyl. V-motor 261-368kW Diesel cyl. 128 dia 20 pcs required</p> <p>OM 424, OM 424 A/LA 900/901 12 cyl. V-motor Diesel cyl. 128 dia. 24 pcs required</p> <p>OM 427, OM 427 H 900/901/905/910/911 OM 427A / LA OM 427 HA 902/903/950/951/952 6 cylinder in-line engine 150-206kW Diesel cyl. 128 dia. 12 pcs required</p>

Valve stem seal

dph-no. 98473
OEM-no. 422 053 01 96

application



Material: FPM

OM 401

M.B. 401: 900/901/905-909/912-916/918/919/921-928

6 cyl. V-motor, 12 pcs required
 129-144kW Diesel cyl. 125 dia

OM 401 A

917

6 cyl. V-motor, 12 pcs required
 188kW Diesel cyl. 125 dia.

OM 402

900/901/905-907/910-914/916/917/919/921/923-928

8cyl. V-motor
 147-188kW Diesel cyl. 125 dia
 from engine 013688, 16 pcs. Required

OM 402 LA Euro I

970-973/975

8 cyl. V-motor 280kW Diesel cyl. 125 dia.
 16 pcs required

OM 403

900/905/906/910/911/915-919/930-935
 10 cyl. V-motor

184-261kW Diesel cyl. 125 dia, 20 pcs. Required

OM 404, OM 404 A

900/901

12 cyl. V-motor Diesel cyl. 125 dia., 24 pcs required

OM 407 / OM407 A, LA, H, HA

900/901/905/907-911/913-920/925/951/955

6 cyl. In-line engine
 132-206kW Diesel cyl. 125 dia., 12 pcs required

OM 409

901

5 cyl. Diesel in-line engine cyl. 125 dia., 10 pcs required

OM 421

900/905-908/910

OM 421 A/LA

901/951

6 cyl. V-motor
 159-184kW Diesel cyl. 128 dia., 12 pcs required

OM 422

900/905-915/917-923

8 cyl. V-motor

184/206kW Diesel cyl. 128 dia.

OM 422

900/905-915/917-923

OM 422 A/LA

901/951-959-963

8 cyl. V-motor

184-276kW Diesel cyl. 128 dia., 16 pcs required

OM 423

900/905-909

OM 423 A/LA

901/950

10 cyl. V-motor

261-368kW Diesel cyl. 128 dia, 20 pcs required

OM 424, OM 424 A/LA

900/901

12 cyl. V-motor Diesel cyl. 128 dia. , 24 pcs required

OM 427, OM 427 H

900/901/905/910/911

OM 427A / LA

OM 427 HA

902/903/950/951/952

6 cylinder in-line engine

150-206kW Diesel cyl. 128 dia.

12 pcs required

OM 441

900/905-909/911-921/923-937

150-165kW

OM 441 Euro I

900/922/932/933

151kW

6 cyl. V-motor Diesel cyl. 128/130 dia.

12 pcs required

OM 441 A / OM 441 LA

901/950/951/953/960-962/985

200-250kW

OM 441 A Euro I, OM 441 LA Euro I

901/980-983/986-990/992/994

250kW

6 cyl. V-motor Diesel cyl. 128/130 dia.

12 pcs required

OM 442

900/905-911/914-930/932-935/939

191-218kW

OM 442 Euro I

900/931

195kW

8 cyl. V-motor Diesel cyl. 128/130 dia.

16 pcs required

OM 442 A / OM 442 LA

901/941-946/950-955/957-968/976/978/980/982/

983/985/989/992-994

269-362kW

OM 442 A Euro I / OM 442 LA Euro I

940-942/972-973

250-370kW

8 cyl. V-motor Diesel cyl. 128/130 dia.

16 pcs required

OM 442

900/905

271kW

OM 443A, OM 443 LA

901/940/980

340-412kW

OM 443 LA Euro I

901-504

10 cyl. V-motor Diesel cyl. 128 dia.

20 pcs required

OM 444 A / OM 444 LA

901

12 cyl. V-motor Diesel cyl. 128 dia.

24 pcs required

OM 447

900

OM 447 Euro I

900-004

OM 447 H

901/905-908, 910-913

150-184kW

OM 447 H Euro I

901-04/914

157kW

OM 447 A, OM 447 LA

902

OM 447 A Euro I, OM 447 LA Euro I

902-404/902-504

OM 447 HA, OM 447 HLA

903/950-953

206kW

OM 447 HA Euro I / OM 447 HLA Euro I

903-604/903-704/956/957/959/981/982/984/986

184-220kW

6 cyl. In-line engine Diesel cyl. 128 dia.

12 pcs required

OM 449 HLA

155-184 kW, 5 cyl. Diesel dia. 128

10 pcs. required

OM 449 A/LA





184-235 kW, 5 cyl. Diesel dia. 128

10 pcs. Required

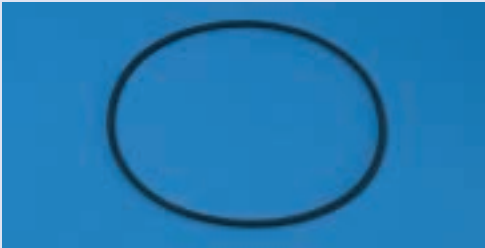

Valve stem seal

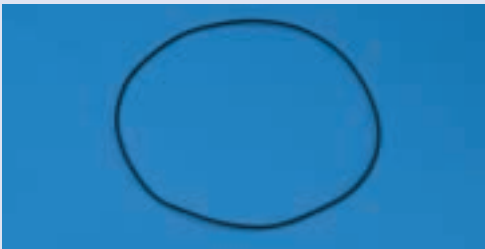
dph-no.	OEM-no.	application
35865	000 053 35 58	 <p>Input/output</p> <p>OM 501 LA / OM 501 LA IMO Actros M.B: 521: 940 M.B: 541: 920-928</p>
		<p>M.B: 941: 910/920/929/930/940/960/970/990 6 cyl. V-motor Diesel 230-315kW 24 pcs required</p> <p>OM 502 LA Actros 8 cyl. V-engine 350-420 kw Diesel 32 pcs required</p> <p>OM 457LA 265/280 kW, 6 cyl. Diesel 24 pcs required</p>



Cylinder liner sealing ring

dph-no.	OEM-no.	application
33288 / 4566	423 011 02 59/ 012 997 12 48	 <p>Size : 144 x 3,8 FPM 75 black</p> <p>OM 423 V-engine 10 cyl. (261-368kW)</p>
104089	541 997 09 45	 <p>OM 501 LA / OM 501 LA IMO Actros M.B: 521: 940 M.B: 541: 920-928</p>
4565	009 997 88 48	 <p>OM 401, OM 401A – 6 cyl (129-188kW) OM 402 – 8 cyl.(147-188kW) OM 403 – 10 cyl. (184-261kW) OM 404, OM 404A – 12 cyl. V-engine OM 407, OM 407A/LA/H/HA – 6 cyl. (132-206kW)</p>
4568	012 997 71 48	 <p>OM 401, OM 401A – 6 cyl (129-188kW) OM 402 – 8 cyl.(147-188kW) OM 403 – 10 cyl. (184-261kW) OM 404, OM 404A – 12 cyl. V-engine OM 407, OM 407A/LA/H/HA – 6 cyl. (132-206kW)</p>



Cylinder liner sealing ring

dph-no.	OEM-no.	application
34899	015 997 90 48	 <p>OM 401, OM 401A – 6 cyl (129-188kW) OM 402 – 8 cyl.(147-188kW) OM 403 – 10 cyl. (184-261kW) OM 404, OM 404A – 12 cyl. V-engine</p> <p>OM 407, OM 407A/LA/H/HA – 6 cyl. (132-206kW) OM 421A, OM 421 V-engine – 6 cyl. (159-184kW) OM 422, OM 422A/A V-engine – 8 cyl. (184-276kW) OM 423, OM 423A/LA V-engine – 10 cyl. (261-368kW) OM 424, OM 424A/LA V-engine – 12 cyl. OM 427, OM 427 A/LA/H/HA – 6 cyl. (105-206kW) OM 441, Om 441 Euro I, OM 442 Euro I V-engine – 8 cyl. (191-218 kW) OM 444, Om 444A/LA V-engine, 12 cyl. OM 447, OM 447A/LA/H/HA/HLA, Om 447 Eurol, Aeuro I, Heurol, HLA Euro I, HLA Euro II –6 cyl. (150-220kW)</p>
34900	015 997 91 48	 <p>OM 401, OM 401A – 6 cyl (129-188kW) OM 402 – 8 cyl.(147-188kW) OM 403 – 10 cyl. (184-261kW) OM 404, OM 404A – 12 cyl. V-engine</p> <p>OM 407, OM 407A/LA/H/HA – 6 cyl. (132-206kW) OM 421A, OM 421 V-engine – 6 cyl. (159-184kW) OM 422, OM 422A/A V-engine – 8 cyl. (184-276kW) OM 423, OM 423A/LA V-engine – 10 cyl. (261-368kW) OM 424, OM 424A/LA V-engine – 12 cyl. OM 427, OM 427 A/LA/H/HA – 6 cyl. (105-206kW) OM 441, Om 441 Euro I, OM 442 Euro I V-engine – 8 cyl. (191-218 kW) OM 444, Om 444A/LA V-engine, 12 cyl. OM 447, OM 447A/LA/H/HA/HLA, Om 447 Eurol, Aeuro I, Heurol, HLA Euro I, HLA Euro II –6 cyl. (150-220kW)</p>



Cylinder liner sealing ring kit

dph-no.	OEM-no.	application
50845	DB 125	 <p>Contents: 2 pcs. 009 997 8848 size: 144x 3,8 green FPM 75 2 pcs. 012 997 7148 size: 140 x 1,9 green FPM 75</p> <p>OM 401, OM 401A – 6 cyl (129-188kW) OM 402 – 8 cyl.(147-188kW) OM 403 – 10 cyl. (184-261kW) OM 404, OM 404A – 12 cyl. V-engine OM 407, OM 407A/LA/H/HA – 6 cyl. (132-206kW)</p>
50846	DB 128	 <p>Contents: 2 pcs. 015 997 9048 size : 140 x 109 FPM 75 green 2 pcs. 015 997 9148 size : 144 x 3,8 FPM 75 green</p> <p>OM 401, OM 401A – 6 cyl (129-188kW) OM 402 – 8 cyl.(147-188kW) OM 403 – 10 cyl. (184-261kW)</p> <p>OM 404, OM 404A – 12 cyl. V-engine OM 407, OM 407A/LA/H/HA – 6 cyl. (132-206kW) OM 421A, OM 421 V-engine – 6 cyl. (159-184kW) OM 422, OM 422A/A V-engine – 8 cyl. (184-276kW) OM 423, OM 423A/LA V-engine – 10 cyl. (261-368kW) OM 424, OM 424A/LA V-engine – 12 cyl. OM 427, OM 427 A/LA/H/HA – 6 cyl. (105-206kW) OM 441, Om 441 Euro I, OM 442 Euro I V-engine – 8 cyl. (191-218 kW) OM 444, Om 444A/LA V-engine, 12 cyl. OM 447, OM 447A/LA/H/HA/HLA, Om 447 Eurol, Aeuro I, Heurol, HLA Euro I, HLA Euro II –6 cyl. (150-220kW)</p>

Cylinder liner sealing ring kit

dph-no.	OEM-no.	application
94872	DB 128 + Tomback ring	 <p>Contents: 1 pcs. 442 011 0059 2 pcs. 015 997 9048 size: 140 x 1,9 FPM green 2 pcs. 015 997 9148 size: 144 x 3,8 FPM green</p> <p>OM 401, OM 401A – 6 cyl (129-188kW) OM 402 – 8 cyl.(147-188kW)</p> <p>OM 403 – 10 cyl. (184-261kW) OM 404, OM 404A – 12 cyl. V-engine OM 407, OM 407A/LA/H/HA – 6 cyl. (132-206kW) OM 421A, OM 421 V-engine – 6 cyl. (159-184kW) OM 422, OM 422A/A V-engine – 8 cyl. (184-276kW) OM 423, OM 423A/LA V-engine – 10 cyl. (261-368kW) OM 424, OM 424A/LA V-engine – 12 cyl. OM 427, OM 427 A/LA/H/HA – 6 cyl. (105-206kW) OM 441, Om 441 Euro I, OM 442 Euro I V-engine – 8 cyl. (191-218 kW) OM 444, Om 444A/LA V-engine, 12 cyl. OM 447, OM 447A/LA/H/HA/HLA, Om 447 Euro I, Aeuro I, Heuro I, HLA Euro I, HLA Euro II – 6 cyl. (150-220kW)</p>
98706		 <p>Actros, 1 cylinder</p> <p>Contents: 1 x 541 011 0059 2 x 541 997 0945</p>
109463	457 997 05 45	 <p>OM457LA (Electronic Injection) L1938, LS1938, L2638, LK2638 , L OM457LA (Electronic Injection) available for the trucks L1938, LS1938, L2638, LK2638 and LS2638. S2638.</p> <p>Actros Contents: 1 x 457 011 0259 1 x liner ring 144x154x7 FPM</p>

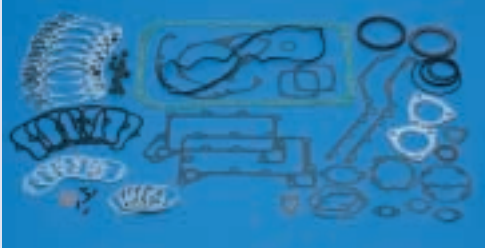
Gasket set complete engine overhaul excl. cylinder liner rings

dph-no.	OEM-no.	application
96842		 <p>OM 401 M.B. 401: 900/901/905-909/912-916/918/919/921-928 6 cyl. V-motor 129-144kW Diesel cyl. 125 dia</p> <p>OM 401 A 917 6 cyl. V-motor 188kW Diesel cyl. 125 dia.</p>
96820		 <p>OM 403 900/905/906/910/911/915-919/930-935 10 cyl. V-motor 184-261kW Diesel cyl. 125 dia</p>

Gasket set complete engine overhaul excl. cylinder liner rings

dph-no.	OEM-no.	application
98553		<p>OM 422 900/905-915/917-923</p> <p>OM 422 A/LA 901/951-959-963 8 cyl. V-motor 184-276kW Diesel cyl. 128 dia.</p>
96519		 <p>OM 442 A / OM 442 LA 901/941-946/950-955/957-968/976/978/980/982/ 983/985/989/992-994 269-362kW</p> <p>OM 442 A Euro I / OM 442 LA Euro I 940-942/972-973 250-370kW 8 cyl. V-motor Diesel cyl. 128/130 dia.</p>

Gasket set complete engine overhaul incl. cylinder liner rings

dph-no.	OEM-no.	application
96260		 <p>OM 352 A 6 cyl. 150-172 PS (110,5-127kW) loader 352 all, 353 all incl. Oil seals up to motor 760548</p>
97260		 <p>OM 352 normal 6 cyl. 100-130 PS (74-96kW) 352 all, 353 all from year 1964</p> <p>incl. Oil seals up to motor 760548</p>
98384	360 010 03 44	 <p>OM 360 910/914-918/930/931/933/935-944/946/948-952/ 960-973/975/979/980/981/983 125-141kW Diesel cyl. 115 dia.</p>
95802		 <p>OM 402 900/901/905-907/910-914/916/917/919/921/923-928 8cyl. V-motor 147-188kW Diesel cyl. 125 dia.</p>



Gasket set complete engine overhaul incl. cylinder liner rings

dph-no.	OEM-no.	application
94585		 <p>OM 442 Euro I 900/931 195kW 8 cyl. V-motor Diesel cyl. 128/130 dia.</p> <p>OM 442 A / OM 442 LA 901/941-946/950-955/957-968/976/ 978/980/982/983/985/989/992-994 269-362kW</p> <p>OM 442 A Euro I / OM 442 LA Euro I 940-942/972-973 250-370kW 8 cyl. V-motor Diesel cyl. 128/130 dia.</p> <p>OM 442 900/905-911/914-930/932-935/939 191-218kW</p>
96633	DB 421	 <p>OM 421 M.B. 421: 900/905-908/910</p> <p>OM 421 A/LA M.B. 421: 901/951 6 cyl. V-motor Diesel 159-184kW cyl. 128 dia.</p>



Full set

dph-no.	OEM-no.	application
96159	355 586 03 90	 <p>Full set, special version OM 355 960, 984 year from 1969 6 cyl. 154,5-191 kW</p>
96634		 <p>M.B. 366: 905-907/909/910/914/917/ 919/930/932/933/936/938/940</p> <p>OM 366 A M.B. 356: 940/943/944/946/948/951/ 953 M.B. 366: 941-943/945/946/951-953/ 957/962/965/967-971/973</p> <p>OM 366 LA M.B. 356: 984/987 M.B. 366: 980/981/983/988/990/993/ 995-997 95-150kW Diesel cyl. 97,5</p> <p>Full set OM 366 M.B. 356: 901/902/904/905/908/910/911/913</p>
96259	OM 314	<p>OM 314 4 cyl. 39-63kW M.B. 314: 910/946-948/949/951/959/961-965 M.B. 314: 900/947/950/954 up to engine 209443 From year 1965</p>

Valve cover gasket

dph-no.	OEM-no.	application
108774	314 016 03 21	 <p>OM 314 Up to engine -492711 From engine 492711 All engine types 40-63kW Diesel cyl. 97dia.</p> <p>MB Trac 65, 70 /440 MB Trac 700, 800, 900 /440 40-63kW Diesel cyl. 97dia. MB Trac 65, 70 /440 700, 800, 900 /440 OM 314 up to engine 492711 MB 314: 956/957 OM 314 A up to engine 492711 MB 314: 970 48-63 kW Diesel cyl. 97 dia. MB Trac 65, 70 / 440 700, 800, 900 / 440 OM 314 from engine 492712 MB: 314: 956/957 OM 314 from engine 492712 MB 314: 970 48-63kW Diesel cy. 97 dia</p>
108773	352 016 09 21	 <p>OM 322 910- 919/970/971 Diesel cyl. 97 dia.</p> <p>OM 352 up to engine 760548 OM 352 A from engine 760548 352 all, 353 all 74-96 kW, Diesel cyl. 97 dia. 96-127kW, Diesel dyl. 97 dia.</p> <p>OM 352 A up to engine 760548 OM 352 A from engine 760549 906/909/910 141kW Diesel cyl. 97 dia.</p> <p>MB Trac 1000 /441 1100 /442, 443 OM 352 up to engine 760548 M.B. 353: 936/949/985 70-81kW Diesel cyl. 97 dia.</p> <p>MB Trac 1000 /441 1100 /442, 443 OM 352 from engine 760549 M.B. 353: 936/949/985 70-81kW Diesel cyl. 97 dia.</p>
69209	352 015 05 22	<p>OM 322 910- 919/970/971 Diesel cyl. 97 dia.</p> <p>OM 352 up to engine 760548 OM 352 A up to engine 760548 352 all, 353 all 74-96 kW, Diesel cyl. 97 dia. 96-127 kW, Diesel cyl. 97 dia.</p>
108776	360 016 02 21	 <p>2 pcs. Required</p> <p>OM 327 914-917/919/921-946 Diesel cyl. 115 dia</p> <p>OM 360 910/914-918/930/931/933/935-944/ 946/948-952/960-973/975/979/980/ 981/983 125-141kW Diesel cyl. 115 dia. OM 360 A 154kW Diesel cyl. 115 dia. OM 360 H 911/912/934/947/954-956/959/974/ 976-978 horizontal engine 125/141kW Diesel cyl. 115 dia.</p> <p>MB Trac 1000 /441 1100 /442, 443 OM 352 up to engine 760548 M.B. 353: 936/949/985 70-81kW Diesel cyl. 97 dia.</p>

Valve cover gasket

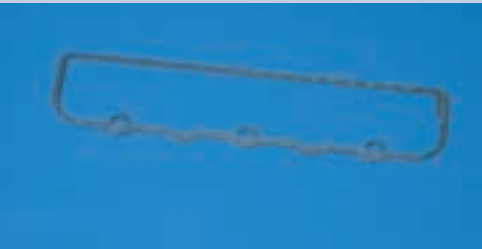
dph-no.	OEM-no.	application
61057 / 36606	355 016 00 21 / 346 016 02 21	 <p>OM 346 Up to engine 027399 910-919/940-947/951-953 154kW Diesel 128 cyl. Dia.</p> <p>All engine types 6 pcs required</p>
95087	366 015 00 60	 <p>OM 352 from engine 760548 OM 352 A from engine 760548 352 all, 353 all 96-127kW, Diesel cyl. 97 dia. 74-96 kW, Diesel cyl. 97 dia.</p> <p>OM 362 LA 906/909/910 141kW Diesel cyl. 97 dia.</p> <p>MB Trac 1000 /441 1100 /442, 443 OM 352 from engine 760549 M.B. 353: 936/949/985 70-81kW Diesel cyl. 97 dia.</p> <p>MB Trac 1000 /441,162 1100 /441,163 1300 /443,163 1400 /443,164 1600 /443,166 OM 366 M.B. 366: 908/912 OM 366 A M.B. 366: 954/958/977 74-115kW Diesel cyl. 97,5 dia.</p> <p>Unimog U900, U1000, U1150, U1200, U1250, U1350, U1400, U1450, U1550, U1600, U1650, U1700, U1750, U2100, U2150</p>
36776 / 80018	364 016 01 21 / 364 016 00 21	 <p>OM 364 906/907/912/918/919/921 OM 364 A 950/952/957/958 OM 364 LA 981/986 63-100kW Diesel cyl. 97,5 dia. MB Trac 700, 800, 900 / 440 OM 364: 908, 909 OM 364: 951, 50-66kW Diesel cyl. 97,5 dia.</p>
37562	366 016 03 21 / 366 016 00 21	 <p>OM 366 M.B. 356: 901/902/904/905/908/910/911/913 M.B. 366: 905-907/909/910/914/917/919/930/ 932/933/936/938/940 OM 366 A M.B. 356: 940/943/944/946/948/951/953 M.B. 366: 941-943/945/946/951-953/957/962/ 965/967-971/973 OM 366 LA M.B. 356: 984/987 M.B. 366: 980/981/983/988/990/993/995-997 95-150kW Diesel cyl. 97,5 OM 366 M.B. 346: 903/909 M.B. 366: 918/931/937</p> <p>MB Trac 1000 /441,162 1100 /441,163 1300 /443,163 1400 /443,164 1600 /443,166 OM 366 M.B. 366: 908/912 OM 366 A M.B. 366: 954/958/977 74-115kW Diesel cyl. 97,5 dia.</p> <p>Unimog U900, U1000, U1150, U1200, U1250, U1350, U1400, U1450, U1550, U1600, U1650, U1700, U1750, U2100, U2150</p>

Valve cover gasket

dph-no.	OEM-no.	application
---------	---------	-------------

82296/	442 016 06 21/	
59272/	442 016 01 21/	
68587	403 016 03 21	



6 pcs required

OM 401

M.B. 401: 900/901/905-909/912-916/918/919/921-928

6 cyl. V-motor
129-144kW Diesel cyl. 125 dia
from engine 001207

OM 401 A

917
6 cyl. V-motor
188kW Diesel cyl. 125 dia.

OM 401 LA Euro I

970/972-974/977-981
6 cyl. V-motor
213-230kW Diesel cyl. 125 dia

OM 402

900/901/905-907/910-914/916/917/919/921/923-928

8cyl. V-motor
147-188kW Diesel cyl. 125 dia
from engine 013688

8 pcs. Required

OM 402 LA Euro I

970-973/975
8 cyl. V-motor 280kW Diesel cyl. 125 dia.
8 pcs required

OM 403

900/905/906/910/911/915-919/930-935

10 cyl. V-motor
184-261kW Diesel cyl. 125 dia
10 pcs. Required
from engine 022608

OM 404, OM 404 A

900/901
12 cyl. V-motor Diesel cyl. 125 dia.
12 pcs required
up to engine 000234
from engine 000234

OM 407 / OM407 A, LA, H, HA

900/901/905/907-911/913-920/925/951/955
6 cyl. In-line engine
132-206kW Diesel cyl. 125 dia.
From engine 002810, 6 pcs required

OM 409

901
5 cyl. Diesel in-line engine cyl. 125 dia.
6 pcs required

OM 421

900/905-908/910
OM 421 A/LA
901/951
6 cyl. V-motor
159-184kW Diesel cyl. 128 dia.
6 pcs required

OM 422

900/905-915/917-923
8 cyl. V-motor, 8 pcs required
184/206kW Diesel cyl. 128 dia.

OM 422

900/905-915/917-923

OM 422 A/LA

901/951-959-963
8 cyl. V-motor
184-276kW Diesel cyl. 128 dia.
8 pcs. Required

OM 423

900/905-909
OM 423 A/LA
901/950
10 cyl. V-motor
261-368kW Diesel cyl. 128 dia
10 pcs required

OM 424, OM 424 A/LA

900/901
12 cyl. V-motor Diesel cyl. 128 dia.
12 pcs required

OM 427, OM 427 H

900/901/905/910/911
OM 427A / LA
OM 427 HA
902/903/950/951/952
6 cylinder in-line engine
150-206kW Diesel cyl. 128 dia.
6 pcs required

OM 441

900/905-909/911-921/923-937
150-165kW

OM 441 Euro I

900/922/932/933
151kW
6 cyl. V-motor Diesel cyl. 128/130 dia.
6 pcs required

OM 441 A / OM 441 LA

901/950/951/953/960-962/985
200-250kW
OM 441 A Euro I, OM 441 LA Euro I
901/980-983/986-990/992/994
250kW
6 cyl. V-motor Diesel cyl. 128/130 dia.
6 pcs required

OM 442

900/905-911/914-930/932-935/939
191-218kW

OM 442 Euro I

900/931
195kW
8 cyl. V-motor Diesel cyl. 128/130 dia.
8 pcs required

OM 442 A / OM 442 LA

901/941-946/950-955/957-968/976/978/980/982/
983/985/989/992-994
269-362kW

OM 442 A Euro I / OM 442 LA Euro I

940-942/972-973
250-370kW
8 cyl. V-motor Diesel cyl. 128/130 dia.
8 pcs required

Valve cover gasket

dph-no.	OEM-no.	application
		<p>OM 442 900/905 271kW</p> <p>OM 443A, OM 443 LA 901/940/980 340-412kW</p> <p>OM 443 LA Euro I 901-504 10 cyl. V-motor Diesel cyl. 128 dia. 10 pcs required</p> <p>OM 444 A / OM 444 LA 901 12 cyl. V-motor Diesel cyl. 128 dia. 12 pcs required</p> <p>OM 447 900</p> <p>OM 447 Euro I 900-004</p>
		<p>OM 447 H 901/905-908, 910-913 150-184kW</p> <p>OM 447 H Euro I 901-04/914 157kW</p> <p>OM 447 A, OM 447 LA 902</p> <p>OM 447 A Euro I, OM 447 LA Euro I 902-404/902-504</p> <p>OM 447 HA, OM 447 HLA 903/950-953 206kW</p> <p>OM 447 HA Euro I / OM 447 HLA Euro I 903-604/903-704/956/957/959/981/982/984/986 184-220kW</p> <p>6 cyl. In-line engine Diesel cyl. 128 dia. 6 pcs required</p> <p>OM 449 HLA 155-184 kW, 5 cyl. Diesel dia. 128</p> <p>OM 449 A/LA 184-235 kW, 5 cyl. Diesel dia. 128</p>
3991	403 016 01 21	 <p>OM 401 M.B. 401: 900/901/905-909/912-916/918/919/ 921-928 6 cyl. V-motor 129-144kW Diesel cyl. 125 dia up to engine 001206 6 pcs required</p>
		<p>OM 402 900/901/905-907/910-914/916/917/ 919/921/923-928 8cyl. V-motor 147-188kW Diesel cyl. 125 dia up to engine 013687 8 pcs. Required</p> <p>OM 403 900/905/906/910/911/915-919/930-935 10 cyl. V-motor 184-261kW Diesel cyl. 125 dia up to engine 022607 10 pcs. Required</p> <p>OM 407 / OM407 A, LA, H, HA 900/901/905/907-911/913-920/925/ 951/955 6 cyl. In-line engine 132-206kW Diesel cyl. 125 dia. Up to engine 002809, 6 pcs required</p>
93426 108784 108785	541 016 03 21 541 016 04 21 457 016 01 21	 <p>OM 501 LA / OM 501 LA IMO Actros M.B: 521: 940</p>
		<p>M.B: 541: 920-928 M.B: 941: 910/920/929/930/940/960/ 970/990 6 cyl. V-motor Diesel 230-315kW 6 pcs required</p> <p>OM 502 LA Actros 8 cyl. V-engine 350-420 kw Diesel 8 pcs required</p>
81268 32394	442 015 00 60 403 015 01 60	 <p>New version Old version</p> <p>engine housing OM 401, 402, 421, 422, 423, 424, 443, 444 A / LA OM 403 OM 404 A OM 441 A/LA Euro I+II OM 442 A/LA Euro I+II</p>



Valve cover gasket

dph-no.	OEM-no.	application
97126	364 184 03 80	



Oil pan gasket

dph-no.	OEM-no.	application
98590	364 010 01 80	 <p>OM 314 Up to engine -492711 From engine 492711 All engine types 40-63kW Diesel cyl. 97dia. Plate-iron</p>
82204	360 014 03 22	 <p>OM 327 914-917/919/921-946 Diesel cyl. 115 dia. OM 360 910/914-918/930/931/933/935-944/946/948-952/ 960-973/975/979/980/981/983 125-141kW Diesel cyl. 115 dia. OM 360 A 154kW Diesel cyl. 115 dia</p>
68590	441 014 00 22	 <p>OM 401 M.B. 401: 900/901/905-909/912-916/918/919/ 921-928 6 cyl. V-motor 129-144kW Diesel cyl. 125 dia OM 401 A 917 6 cyl. V-motor 188kW Diesel cyl. 125 dia. OM 401 LA Euro I 970/972-974/977-981 6 cyl. V-motor 213-230kW Diesel cyl. 125 dia</p> <p>OM 421 900/905-908/910 OM 421 A/LA 901/951 6 cyl. V-motor 159-184kW Diesel cyl. 128 dia.</p> <p>OM 441 900/905-909/911-921/923-937 150-165kW OM 441 Euro I 900/922/932/933 151kW 6 cyl. V-motor Diesel cyl. 128/130 dia.</p> <p>OM 441 A / OM 441 LA 901/950/951/953/960-962/985 200-250kW OM 441 A Euro I, OM 441 LA Euro I 901/980-983/986-990/992/994 250kW 6 cyl. V-motor Diesel cyl. 128/130 dia.</p>

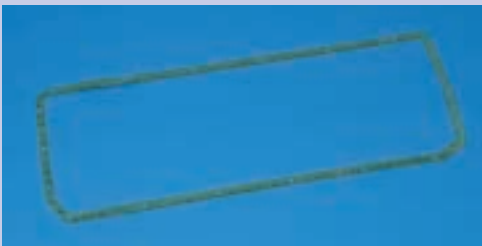
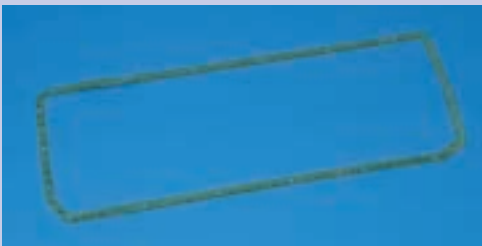
Oil pan gasket

dph-no.	OEM-no.	application	
37622	442 014 02 22	 <p>OM 402 900/901/905-907/910-914/916/917/919/921/923-928 8cyl. V-motor 147-188kW Diesel cyl. 125 dia</p> <p>OM 402 LA Euro I 970-973/975 8 cyl. V-motor 280kW Diesel cyl. 125 dia.</p> <p>OM 422 900/905-915/917-923 8 cyl. V-motor 184/206kW Diesel cyl. 128 dia.</p>	<p>OM 422 900/905-915/917-923</p> <p>OM 422 A/LA 901/951-959-963 8 cyl. V-motor 184-276kW Diesel cyl. 128 dia.</p> <p>OM 442 900/905-911/914-930/932-935/939 191-218kW</p> <p>OM 442 Euro I 900/931 195kW 8 cyl. V-motor Diesel cyl. 128/130 dia.</p> <p>OM 442 A / OM 442 LA 901/941-946/950-955/957-968/976/978/980/982/983/985/989/992-994 269-362kW</p> <p>OM 442 A Euro I / OM 442 LA Euro I 940-942/972-973 250-370kW 8 cyl. V-motor Diesel cyl. 128/130 dia.</p>
		 <p>OM 403 900/905/906/910/911/915-919/930-935 10 cyl. V-motor 184-261kW Diesel cyl. 125 dia</p> <p>OM 423 900/905-909</p>	<p>OM 423 A/LA 901/950 10 cyl. V-motor 261-368kW Diesel cyl. 128 dia</p> <p>OM 442 900/905 271kW</p> <p>OM 443A, OM 443 LA 901/940/980 340-412kW</p> <p>OM 443 LA Euro I 901-504 10 cyl. V-motor Diesel cyl. 128 dia.</p> <p>OM 457LA 265/280 kW, 6 cyl. Diesel</p>
81192	447 014 00 22	 <p>OM 407 / OM407 A, LA, H, HA 900/901/905/907-911/913-920/925/951/955 6 cyl. In-line engine 132-206kW Diesel cyl. 125 dia.</p> <p>OM 427, OM 427 H 900/901/905/910/911</p> <p>OM 427A / LA OM 427 HA 902/903/950/951/952 6 cylinder in-line engine 150-206kW Diesel cyl. 128 dia.</p>	<p>OM 447 900</p> <p>OM 447 Euro I 900-004</p> <p>OM 447 H 901/905-908, 910-913 150-184kW</p> <p>OM 447 H Euro I 901-04/914 157kW</p> <p>OM 447 A, OM 447 LA 902</p> <p>OM 447 A Euro I, OM 447 LA Euro I 902-404/902-504</p> <p>OM 447 HA, OM 447 HLA 903/950-953 206kW</p> <p>OM 447 HA Euro I / OM 447 HLA Euro I 903-604/903-704/956/957/959/981/ 982/984/986 184-220kW 6 cyl. In-line engine Diesel cyl. 128 dia.</p>
			<p>OM 409 5 cyl. dia 125 in-line engine</p> <p>OM 409 HLA 155-184 kW 5 cyl. dia 128 in-line engine</p>
109795	405 014 02 22		<p>OM 409 5 cyl. dia 125 in-line engine</p> <p>OM 409 HLA 155-184 kW 5 cyl. dia 128 in-line engine</p>

Oil pan gasket kit

dph-no.	OEM-no.	application
5270 59271	314 010 02 80 314 010 02 80 (kork)	 <p>OM 314 Up to engine -492711 From engine 492711 All engine types 40-63kW Diesel cyl. 97dia. Cast-iron</p> <p>MB Trac 65, 70 / 440 MB Trac 700, 800, 900 / 440 40-63kW Diesel cyl. 97dia.</p> <p>MB Trac 700, 800, 900 / 440 50-66kW Diesel cyl. 97,5 dia.</p> <p>MB Trac 65, 70 / 440 700, 800, 900 / 440 OM 314 up to engine 492711 MB 314: 956/957 OM 314 A up to engine 492711 MB 314: 970 48-63 kW Diesel cyl. 97 dia.</p> <p>MB Trac 65, 70 / 440 700, 800, 900 / 440 OM 314 from engine 492712 MB: 314: 956/957 OM 314 from engine 492712 MB 314: 970 48-63kW Diesel cy. 97 dia</p> <p>MB Trac 700, 800, 900 / 440 OM 364: 908, 909 OM 364: 951 50-66kW Diesel cyl. 97,5 dia.</p>
70565	352 010 08 80	 <p>OM 322 910-919/970/971 Diesel cyl. 97 dia.</p> <p>OM 366 M.B. 356: 901/902/904/905/908/910/911/913 M.B. 366: 905-907/909/910/914/917/919/930/ 932/933/936/938/940 OM 366 A M.B. 356: 940/943/944/946/948/951/953 MB. 366: 941-943/945/946/951-953/957/962/ 965/967-971/973</p> <p>OM 366 LA M.B. 356: 984/987 M.B. 366: 980/981/983/988/990/993/ 995-997 95-150kW Diesel cyl. 97,5</p> <p>OM 366 LA M.B. 356: 979/983/989/991/996/999 M.B. 366: 901/999</p> <p>OM 352 A up to engine 760548 OM 352 A from engine 760549 352 all, 353 all 96-127kW, Diesel cyl. 97 dia</p> <p>OM 352 up to engine 760548 OM 352 from engine 760548 352 all, 353 all 74-96kW, Diesel cyl. 97 dia</p> <p>OM 362 LA 906/909/910 141kW Diesel cyl. 97 dia.</p>
96160	355 010 00 27	<p>OM 346 Up to engine 027399 910-919/940-947/951-953 154kW Diesel 128 cyl. Dia.</p> <p>All engine types OM 355, OM 355A/LA All engine types 136-207kW Diesel cyl. 128 dia</p>



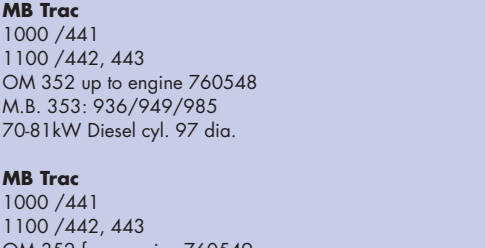

Oil pan gasket kit

dph-no.	OEM-no.	application	
98590	364 010 01 80		 <p>OM 364 906/907/912/918/919/921 OM 364 A 950/952/957/958 OM 364 LA 981/986 63-100kW Diesel cyl. 97,5 dia.</p>
82961	352 010 04 80	MB Trac	 <p>MB Trac 1000 /441,162 1100 /441,163 1300 /443,163 1400 /443,164 1600 /443,166 OM 366 M.B. 366: 908/912 OM 366 A M.B. 366: 954/958/977 74-115kW Diesel cyl. 97,5 dia.</p> <p>Unimog U900, U1000, U1150, U1200, U1250, U1350, U1400, U1450, U1550, U1600, U1650, U1700, U1750, U2100, U2150</p>
59269	352 010 12 80 (kork)	1000 /441 1100 /442, 443	
59268	352 010 12 80	OM 352 up to engine 760548 M.B. 353: 936/949/985 70-81kW Diesel cyl. 97 dia.	
		MB Trac 1000 /441 1100 /442, 443 OM 352 from engine 760549 M.B. 353: 936/949/985 70-81kW Diesel cyl. 97 dia.	

Manifold gasket

dph-no.	OEM-no.	application	
95082	314 142 03 80		 <p>MB Trac 65, 70 /440 700, 800, 900 /440 OM 314 up to engine 492711 MB 314: 956/957 OM 314 A up to engine 492711 MB 314: 970 48-63 kW Diesel cyl. 97 dia.</p> <p>MB Trac 65, 70 / 440 700, 800, 900 / 440 OM 314 from engine 492712 MB: 314: 956/957 OM 314 from engine 492712 MB 314: 970 48-63kW Diesel cy. 97 dia</p>
		OM 314 Up to engine -492711 From engine 492711 All engine types 40-63kW Diesel cyl. 97dia.	
		MB Trac 65, 70 /440 MB Trac 700, 800, 900 /440 40-63kW Diesel cyl. 97dia.	
82206 / 36607	355 141 02 80 / 346 141 01 80		 <p>OM 346 Up to engine 027399 910-919/940-947/951-953 154kW Diesel 128 cyl. Dia. All engine types OM 346, 2 pcs required</p> <p>OM 355, OM 355A/LA All engine types 136-207kW Diesel cyl. 128 dia, 2 pcs required</p>

Manifold gasket

dph-no.	OEM-no.	application	
32506	352 142 04 80	 <p>2 pcs required</p> <p>OM 322 910- 919/970/971 Diesel cyl. 97 dia.</p> <p>OM 352 up to engine 760548 OM 352 from engine 769548 352 all, 353 all, 74-96kW, Diesel cyl. 97 dia</p>	<p>OM 352 A up to engine 760548 OM 352 A from engine 760549 352 all, 353 all, 96-127kW, Diesel cyl. 97 dia</p> <p>OM 362 LA 906/909/910 141kW Diesel cyl. 97 dia.</p> <p>MB Trac 1000 /441 1100 /442, 443 OM 352 up to engine 760548 M.B. 353: 936/949/985 70-81kW Diesel cyl. 97 dia.</p> <p>MB Trac 1000 /441 1100 /442, 443 OM 352 from engine 760549 M.B. 353: 936/949/985 70-81kW Diesel cyl. 97 dia.</p>
		 <p>OM 364 906/907/912/918/919/921 OM 364 A 950/952/957/958 OM 364 LA 981/986 63-100kW Diesel cyl. 97,5 dia. 3 pcs required</p> <p>OM 366 M.B. 356: 901/902/904/905/908/910/911/913 M.B. 366: 905-907/909/910/914/917/919/930/ 932/933/936/938/940 OM 366 A M.B. 356: 940/943/944/946/948/951/953 M.B. 366: 941-943/945/946/951-953/957/962/ 965/967-971/973 OM 366 LA M.B. 356: 984/987 M.B. 366: 980/981/983/988/990/993/995-997 95-150kW Diesel cyl. 97,5</p>	<p>OM 366 M.B. 346: 903/909 M.B. 366: 918/931/937 OM 366 A M.B. 356: 941/945/947/952 M.B. 366: 944/966/974/976/978/979 OM 366LA M.B. 356: 985/986/990/992/994/995 M.B. 366: 992/994 95-150kW Diesel cyl. 97,5 OM 366 LA M.B. 356: 979/983/989/991/996/999 M.B. 366: 901/999 4 pcs required</p> <p>MB Trac 700, 800, 900 / 440 OM 364: 908, 909 OM 364: 951 50-66kW Diesel cyl. 97,5 dia. 3 pcs required</p> <p>MB Trac 1000 /441,162 1100 /441,163 1300 /443,163 1400 /443,164 1600 /443,166 OM 366 M.B. 366: 908/912 OM 366 A M.B. 366: 954/958/977 74-115kW Diesel cyl. 97,5 dia. 4 pcs required</p>
95073	366 142 04 80		<p>OM 364, A, LA, LA Euro II 61-100kW Diesel 97,5 dia cyl.</p> <p>OM 366, A, LA 95-150 kW Diesel 97,5 dia cyl. OM 366A Euro II, OM 366LA Euro II 125/155kW Diesel 97,5 dia. OM 366 A Euro, OM 366 LA Euro II 125/125 kW Diesel 97,5 cyl.</p>
61056	345 142 00 80 355 142 04 80 355 142 01 80		<p>OM 355, OM 355A/LA All engine types 136-207kW Diesel cyl. 128 dia 6 pcs required</p>
36608	346 142 00 60		

Manifold gasket

dph-no.	OEM-no.	application
4211	403 142 03 80	 <p>OM 401 M.B. 401: 900/901/905-909/912-916/918/919/921-928 6 cyl. V-motor 129-144kW Diesel cyl. 125 dia</p> <p>OM 401 A 917 6 cyl. V-motor 188kW Diesel cyl. 125 dia.</p> <p>OM 401 LA Euro I 970/972-974/977-981 6 cyl. V-motor 213-230kW Diesel cyl. 125 dia</p> <p>OM 402 900/901/905-907/910-914/916/917/919/921/923-928 8cyl. V-motor 147-188kW Diesel cyl. 125 dia 8 pcs. Required</p> <p>OM 402 LA Euro I 970-973/975 8 cyl. V-280kW Diesel cyl. 125 dia., 8 pcs required</p> <p>OM 403 900/905/906/910/911/915-919/930-935 10 cyl. V-motor 184-261kW Diesel cyl. 125 dia, 10 pcs. Required</p> <p>OM 404, OM 404 A 900/901 12 cyl. V-motor Diesel cyl. 125 dia., 12 pcs required</p> <p>OM 407 / OM407 A, LA, H, HA 900/901/905/907-911/913-920/925/951/955 6 cyl. In-line engine 132-206kW Diesel cyl. 125 dia. 6 pcs required 905/907-911/951/955</p> <p>OM 409 901 5 cyl. Diesel in-line engine cyl. 125 dia. , 5 pcs required</p> <p>OM 422 900/905-915/917-923 8 cyl. V-motor, 8 pcs required 184/206kW Diesel cyl. 128 dia.</p> <p>OM 422 900/905-915/917-923 OM 422 A/LA 901/951-959-963 8 cyl. V-motor 184-276kW Diesel cyl. 128 dia. , 8 pcs required</p> <p>OM 423 900/905-909 OM 423 A/LA 901/950 10 cyl. V-motor 261-368kW Diesel cyl. 128 dia 10 pcs required</p> <p>OM 424, OM 424 A/LA 900/901 12 cyl. V-Diesel cyl. 128 dia., 12 pcs required</p> <p>OM 441 900/905-909/911-921/923-937 150-165kW</p> <p>OM 441 Euro I 900/922/932/933 151kW 6 cyl. V-motor Diesel cyl. 128/130 dia. 6 pcs required</p> <p>OM 441 A / OM 441 LA 901/950/951/953/960-962/985 200-250kW</p> <p>OM 441 A Euro I, OM 441 LA Euro I 901/980-983/986-990/992/994 250kW 6 cyl. V-motor Diesel cyl. 128/130 dia. 6 pcs required</p> <p>OM 442 900/905-911/914-930/932-935/939 191-218kW</p> <p>OM 442 Euro I 900/931 195kW 8 cyl. V-motor Diesel cyl. 128/130 dia. 8 pcs required</p> <p>OM 442 A / OM 442 LA 901/941-946/950-955/957-968/976/978/980/982/983/985/989/992-994 269-362kW</p> <p>OM 442 A Euro I / OM 442 LA Euro I 940-942/972-973 250-370kW 8 cyl. V-motor Diesel cyl. 128/130 dia. 8 pcs required</p> <p>OM 443 900/905 271kW</p> <p>OM 443A, OM 443 LA 901/940/980 340-412kW</p> <p>OM 443 LA Euro I 901-504 10 cyl. V-motor Diesel cyl. 128 dia. 10 pcs required</p> <p>OM 444 A / OM 444 LA 901 12 cyl. V-motor Diesel cyl. 128 dia. 12 pcs required</p> <p>OM 447 900</p> <p>OM 447 Euro I 900-004</p> <p>OM 447 H 901/905-908, 910-913 150-184kW</p> <p>OM 447 H Euro I 901-04/914 157kW</p> <p>OM 447 A, OM 447 LA 902</p> <p>OM 447 A Euro I, OM 447 LA Euro I 902-404/902-504</p> <p>OM 447 HA, OM 447 HLA 903/950-953 206kW</p> <p>OM 447 HA Euro I / OM 447 HLA Euro I 903-604/903-704/956/957/959/981/982/984/986 184-220kW 6 cyl. In-line engine Diesel cyl. 128 dia. For: 957/959/984/986, 6 pcs required</p> <p>OM 457LA 265/280 kW, 6 cyl. Diesel , 6 pcs required</p> <p>OM 449 A/LA 184-235 kW, 5 cyl. Diesel dia. 128 5 pcs required</p>

Manifold gasket

dph-no. OEM-no. application

81777 442 141 17 80



OM 401

M.B. 401: 900/901/905-909/912-916/918/919/921-928

6 cyl. V-motor, 6 pcs. required
129-144kW Diesel cyl. 125 dia.

OM 401 A

917

6 cyl. V-motor, 6 pcs. required
188kW Diesel cyl. 125 dia.

OM 401 LA Euro I

970/972-974/977-981

6 cyl. V-motor, 6 pcs. required
213-230kW Diesel cyl. 125 dia

OM 402

900/901/905-907/910-914/916/917/919/921/923-928

8cyl. V-motor
147-188kW Diesel cyl. 125 dia, 8 pcs. Required

OM 402 LA Euro I

970-973/975

8 cyl. V-280kW Diesel cyl. 125 dia., 8 pcs required

OM 403

900/905/906/910/911/915-919/930-935

10 cyl. V-motor
184-261kW Diesel cyl. 125 dia, 10 pcs. Required

OM 404, OM 404 A

900/901

12 cyl. V-motor Diesel cyl. 125 dia., 12 pcs required

OM 407 / OM407 A, LA, H, HA

900/901/905/907-911/913-920/925/951/955

6 cyl. In-line engine, 6 pcs required
132-206kW Diesel cyl. 125 dia.

OM 409

901

5 cyl. Diesel in-line engine cyl. 125 dia. , 5 pcs required

OM 421

900/905-908/910

OM 421 A/LA

901/951

6 cyl. V-motor
159-184kW Diesel cyl. 128 dia., 6 pcs required

OM 422

900/905-915/917-923

8 cyl. V-motor, 8 pcs required
184/206kW Diesel cyl. 128 dia.

OM 422

900/905-915/917-923

OM 422 A/LA

901/951-959-963

8 cyl. V-motor, 8 pcs required
184-276kW Diesel cyl. 128 dia.

OM 423

900/905-909

OM 423 A/LA

901/950

10 cyl. V-motor
261-368kW Diesel cyl. 128 dia, 10 pcs required

OM 424, OM 424 A/LA

900/901

12 cyl. V-motor Diesel cyl. 128 dia.
12 pcs required

OM 427, OM 427 H

900/901/905/910/911

OM 427A / LA

OM 427 HA

902/903/950/951/952

6 cylinder in-line engine
150-206kW Diesel cyl. 128 dia.
6 pcs required

OM 441

900/905-909/911-921/923-937

150-165kW

OM 441 Euro I

900/922/932/933

151kW

6 cyl. V-motor Diesel cyl. 128/130 dia.

6 pcs required

OM 441 A / OM 441 LA

901/950/951/953/960-962/985

200-250kW

OM 441 A Euro I, OM 441 LA Euro I

901/980-983/986-990/992/994

250kW

6 cyl. V-motor Diesel cyl. 128/130 dia.

6 pcs required

OM 442

900/905-911/914-930/932-935/939

191-218kW

OM 442 Euro I

900/931

195kW

8 cyl. V-motor Diesel cyl. 128/130 dia.

8 pcs required

OM 442 A / OM 442 LA

901/941-946/950-955/957-968/976/978/980/982/

983/985/989/992-994

269-362kW

OM 442 A Euro I / OM 442 LA Euro I

940-942/972-973

250-370kW

8 cyl. V-motor Diesel cyl. 128/130 dia.

8 pcs required

OM 443

900/905

271kW

OM 443A, OM 443 LA

901/940/980

340-412kW

OM 443 LA Euro I

901-504

10 cyl. V-motor Diesel cyl. 128 dia.

10 pcs required

OM 444 A / OM 444 LA

901

12 cyl. V-motor Diesel cyl. 128 dia.

12 pcs required

OM 447

900-004

OM 447 Euro I

900-004

OM 447 H

901/905-908, 910-913

150-184kW

OM 447 H Euro I

901-04/914

157kW

Manifold gasket

dph-no.	OEM-no.	application
		<p>OM 447 A, OM 447 LA 902 OM 447 A Euro I, OM 447 LA Euro I 902-404/902-504 OM 447 HA, OM 447 HLA 903/950-953 206kW</p>
		<p>OM 447 HA Euro I / OM 447 HLA Euro I 903-604/903-704/956/957/959/981/982/984/986 184-220kW 6 cyl. In-line engine Diesel cyl. 128 dia. 6 pcs required</p> <p>OM 449 HLA 155-184 kW, 5 cyl. Diesel dia. 128</p> <p>OM 449 A/LA 184-235 kW, 5 cyl. Diesel dia. 128</p>
82157	442 141 07 80	 <p>OM 402 900/901/905-907/910-914/916/917/919/921/ 923-928 8cyl. V-motor 147-188kW Diesel cyl. 125 dia 2 pcs. Required</p> <p>OM 403 900/905/906/910/911/915-919/930-935 10 cyl. V-motor 184-261kW Diesel cyl. 125 dia 2 pcs. Required</p> <p>OM 421 900/905-908/910 OM 421 A/LA 901/951 6 cyl. V-motor 159-184kW Diesel cyl. 128 dia. 2 pcs required 905/906-908/910</p> <p>OM 422 900/905-915/917-923 8 cyl. V-motor, 2 pcs required 184/206kW Diesel cyl. 128 dia.</p> <p>OM 422 900/905-915/917-923 OM 422 A/LA 901/951-959-963 8 cyl. V-motor 184-276kW Diesel cyl. 128 dia. 2 pcs required</p>
		<p>OM 423 900/905-909 OM 423 A/LA 901/950 10 cyl. V-motor 261-368kW Diesel cyl. 128 dia 2 pcs required</p> <p>OM 441 900/905-909/911-921/923-937 150-165kW OM 441 Euro I 900/922/932/933 151kW 6 cyl. V-motor Diesel cyl. 128/130 dia. 2 pcs required</p> <p>OM 441 A / OM 441 LA 901/950/951/953/960-962/985 200-250kW OM 441 A Euro I, OM 441 LA Euro I 901/980-983/986-990/992/994 250kW 6 cyl. V-motor Diesel cyl. 128/130 dia. 2 pcs required</p> <p>OM 442 900/905-911/914-930/932-935/939 191-218kW OM 442 Euro I 900/931 195kW 8 cyl. V-motor Diesel cyl. 128/130 dia. 2 pcs required</p> <p>OM 442 A / OM 442 LA 901/941-946/950-955/957-968/976/ 978/980/982/983/985/989/992-994 269-362kW OM 442 A Euro I / OM 442 LA Euro I 940-942/972-973 250-370kW 8 cyl. V-motor Diesel cyl. 128/130 dia. 2 pcs required</p>
98609	541 142 01 80	 <p>OM 501 LA / OM 501 LA IMO Actros M.B: 521: 940 M.B: 541: 920-928 M.B: 941: 910/920/929/930/940/960/970/990 6 cyl. V-motor Diesel 230-315kW, 6 pcs required</p> <p>OM 502 LA Actros 8 cyl. V-engine 350-420 kw Diesel, 8 pcs required</p>

Manifold gasket

dph-no.	OEM-no.	application
98610	541 098 04 80	 <p>OM 501 LA / OM 501 LA IMO Actros M.B: 521: 940 M.B: 541: 920-928 M.B: 941: 910/920/929/930/940/960/970/990 6 cyl. V-motor Diesel 230-315kW 6 pcs required</p>
95816	422 142 00 80	

Repair kit

dph-no.	OEM-no.	application
95867	402 130 02 20 compressor	 <p>OM 401 M.B. 401: 900/901/905-909/912-916/918/919/ 921-928 6 cyl. V-motor 129-144kW Diesel cyl. 125 dia from engine 001207</p> <p>OM 401 A 917 6 cyl. V-motor 188kW Diesel cyl. 125 dia.</p> <p>OM 401 LA Euro I 970/972-974/977-981 6 cyl. V-motor 213-230kW Diesel cyl. 125 dia</p> <p>OM 402 900/901/905-907/910-914/916/917/919/921/ 923-928 8cyl. V-motor 147-188kW Diesel cyl. 125 dia.</p> <p>OM 403 900/905/906/910/911/915-919/930-935 10 cyl. V-motor 184-261kW Diesel cyl. 125 dia</p> <p>OM 407 / OM407 A, LA, H, HA 900/901/905/907-911/913-920/925/ 951/955 6 cyl. In-line engine 132-206kW Diesel cyl. 125 dia.</p> <p>OM 409 901 5 cyl. Diesel in-line engine cyl. 125 dia.</p> <p>OM 421 900/905-908/910</p> <p>OM 421 A/LA 901/951 6 cyl. V-motor 159-184kW Diesel cyl. 128 dia. 905-907 <468903 908/951, 910 <612006</p> <p>OM 423 900/905-909</p> <p>OM 423 A/LA 901/950 10 cyl. V-motor 261-368kW Diesel cyl. 128 dia 906/909/905/907/908 <468903 950 <592679</p>

Engine parts, fuel, exhaust and cooling system parts

Washer – engine

dph-no.	OEM-no.	application
37246	007603 026109	 <p>Size: 26 x 34 x 2 CU</p> <p>OM 314 Up to engine -492711 From engine 492711 All engine types 40-63kW Diesel cyl. 97dia.</p> <p>OM 352 up to engine 760548 OM 352 from engine 769548 352 all, 353 all, 2 pcs. 74-96kW, Diesel cyl. 97 dia OM 352 A up to engine 760548 OM 352 A from engine 760549 352 all, 353 all, 2 pcs 96-127kW, Diesel cyl. 97 dia</p> <p>OM 362 LA 906/909/910 141kW Diesel cyl. 97 dia.</p> <p>OM 364 906/907/912/918/919/921</p> <p>OM 364 A 950/952/957/958</p> <p>OM 364 LA 981/986 63-100kW Diesel cyl. 97,5 dia.</p> <p>OM 366 M.B. 356: 901/902/904/905/908/910/911/913 M.B. 366: 905-907/909/910/914/917/919/930/ 932/933/936/938/940 OM 366 A M.B. 356: 940/943/944/946/948/951/953 M.B. 366: 941-943/945/946/951-953/957/962/ 965/967-971/973 OM 366 LA M.B. 356: 984/987 M.B. 366: 980/981/983/988/990/993/995-997 95-150kW Diesel cyl. 97,5 OM 366 M.B. 346: 903/909 M.B. 366: 918/931/937 OM 366 A M.B. 356: 941/945/947/952 M.B. 366: 944/966/974/976/978/979 OM 366LA M.B. 356: 985/986/990/992/994/995 M.B. 366: 992/994 95-150kW Diesel cyl. 97,5 OM 366 LA M.B. 356: 979/983/989/991/996/999 M.B. 366: 901/999 155-177kW Diesel cyl. 97,5 dia.</p> <p>OM 401 M.B. 401: 900/901/905-909/912-916/918/919/921-928 6 cyl. V-motor 129-144kW Diesel cyl. 125 dia OM 401 A 917 6 cyl. V-motor 188kW Diesel cyl. 125 dia. OM 401 LA Euro I 970/972-974/977-981 6 cyl. V-motor 213-230kW Diesel cyl. 125 dia OM 402 900/901/905-907/910-914/916/917/919/921/923-928 8cyl. V-motor 147-188kW Diesel cyl. 125 dia OM 402 LA Euro I 970-973/975 8 cyl. V-motor 280kW Diesel cyl. 125 dia.</p> <p>OM 403 900/905/906/910/911/915-919/930-935 10 cyl. V-motor 184-261kW Diesel cyl. 125 dia</p> <p>OM 407 / OM407 A, LA, H, HA 900/901/905/907-911/913-920/925/951/955 6 cyl. In-line engine 132-206kW Diesel cyl. 125 dia.</p> <p>OM 409 901 5 cyl. Diesel in-line engine cyl. 125 dia.</p> <p>OM 421 900/905-908/910 OM 421 A/LA 901/951 6 cyl. V-motor, 2 pcs required 159-184kW Diesel cyl. 128 dia.</p> <p>OM 422 900/905-915/917-923 8 cyl. V-motor 184/206kW Diesel cyl. 128 dia. OM 422 900/905-915/917-923 OM 422 A/LA 901/951-959-963 8 cyl. V-motor 184-276kW Diesel cyl. 128 dia.</p> <p>OM 423 900/905-909 OM 423 A/LA 901/950 10 cyl. V-motor 261-368kW Diesel cyl. 128 dia</p> <p>OM 427, OM 427 H 900/901/905/910/911 OM 427A / LA, OM 427 HA 902/903/950/951/952 6 cylinder in-line engine 150-206kW Diesel cyl. 128 dia.</p>

Washer – engine

dph-no.	OEM-no.	application
		OM 441 900/905-909/911-921/923-937 150-165kW OM 441 Euro I 900/922/932/933 151kW 6 cyl. V-motor Diesel cyl. 128/130 dia.
		OM 441 A / OM 441 LA 901/950/951/953/960-962/985 200-250kW OM 441 A Euro I, OM 441 LA Euro I 901/980-983/986-990/992/994 250kW 6 cyl. V-motor Diesel cyl. 128/130 dia.
		OM 442 900/905-911/914-930/932-935/939 191-218kW OM 442 Euro I 900/931 195kW 8 cyl. V-motor Diesel cyl. 128/130 dia. OM 442 A / OM 442 LA 901/941-946/950-955/957-968/976/978/980/ 982/983/985/989/992-994 269-362kW OM 442 A Euro I / OM 442 LA Euro I 940-942/972-973 250-370kW 8 cyl. V-motor Diesel cyl. 128/130 dia.
		OM 443 900/905 271kW OM 443A, OM 443 LA 901/940/980 340-412kW OM 443 LA Euro I 901-504 10 cyl. V-motor Diesel cyl. 128 dia.
		OM 447 900 OM 447 Euro I 900-004 OM 447 H 901/905-908, 910-913 150-184kW OM 447 H Euro I 901-04/914 157kW OM 447 A, OM 447 LA 902 OM 447 A Euro I, OM 447 LA Euro I 902-404/902-504 OM 447 HA, OM 447 HLA 903/950-953 206kW
		OM 447 HA Euro I / OM 447 HLA Euro I 903-604/903-704/956/957/959/981/982/984/986 184-220kW 6 cyl. In-line engine Diesel cyl. 128 dia.
		MB Trac 65, 70 /440 MB Trac 700, 800, 900 /440 40-63kW Diesel cyl. 97dia.
		MB Trac 65, 70 /440 700, 800, 900 /440 OM 314 up to engine 492711 MB 314: 956/957 OM 314 A up to engine 492711 MB 314: 970 48-63 kW Diesel cyl. 97 dia. MB Trac 65, 70 / 440 700, 800, 900 / 440 OM 314 from engine 492712 MB: 314: 956/957 OM 314 from engine 492712 MB 314: 970 48-63kW Diesel cy. 97 dia MB Trac 1000 /441 1100 /442, 443 OM 352 up to engine 760548 M.B. 353: 936/949/985 70-81kW Diesel cyl. 97 dia. MB Trac 1000 /441 1100 /442, 443 OM 352 from engine 760549 M.B. 353: 936/949/985 70-81kW Diesel cyl. 97 dia. MB Trac 1000 /441,162 1100 /441,163 1300 /443,163 1400 /443,164 1600 /443,166 OM 366 M.B. 366: 908/912 OM 366 A M.B: 366: 954/958/977 74-115kW Diesel cyl. 97,5 dia.
		Unimog U900, U1000, U1150, U1200, U1250, U1350, U1400, U1450, U1550, U1600, U1650, U1700, U1750, U2100, U2150 OM 457LA 265/280 kW, 6 cyl. Diesel

Washer – engine

dph-no.	OEM-no.	application
47914	007603 026101	Size: 26 x 32 x 2 CU OM 314 – motor 492711 All engine types 40-63kW Diesel cyl. 97dia.
47919	007603 026305	Size: 26 x 34 x 2,5 OM 352 up to engine, 760548 OM 352 from engine 760548 352 all, 353 all 74-96kW, Diesel cyl. 97 dia
47915	007603 026104	Size: 26 x 31 x 2 CU OM 360 910/914-918/930/931/933/935-944/946/948-952/960-973/975/979/980/981/983 125-141kW Diesel cyl. 115 dia. OM 360 A 154kW Diesel cyl. 115 dia. OM 360 H 911/912/934/947/954-956/959/974/976-978 horizontal engine 125/141kW Diesel cyl. 115 dia.
32948	352 078 00 80	Size: 8 x 12 x 8 CU injection
80569	357 333 00 64	Size: 54 x 80 x 3 NBR 70 Material: rubber NBR
80476	007603 014106	Size: 14 x 20 x 1,5 CU OM 355

O-ring/seal ring

dph-no.	OEM-no.	application
34313	000 997 5348	 <p>Size: 36,4 x 3,2</p> <p>OM 401 LA M.B. 970/972-975/977-981/984-987/989-991/993/994</p> <p>OM 401 LA M.B. 970,972-975, 977-981, 984-987, 989-991, 993, 994</p> <p>OM 402LA M.B. 970,972-975, 977, 982-987, 989, 990, 995, 996</p> <p>OM421/A up to 532630 M.B. 905-908, 910, 951</p> <p>OM 422 up to 532630 M.B. 905-915, 917-923</p> <p>OM422A/LA M.B. 952-959, 963</p> <p>OM 423/LA up to 532630 M.B. 905-909, 950</p> <p>OM 441 M.B. 920-927, 932, 933</p> <p>OM 441 up to 532630 M.B. 905, 908, 909, 911-919</p> <p>OM 441 A/LA M.B. 950/951/953/960/961/980-983/985-999</p> <p>OM 441 LA M.B. 920-927-929-931, 933-941</p> <p>OM 442 M.B. 907, 909</p> <p>OM 442 up to 532630 M.B. 905-911, 914-935, 939</p> <p>OM 442 A M.B. 940-942, 945</p> <p>OM 442 A M.B. 941-946, 950, 952, 954, 955, 957-968, 971, 972, 976-978</p> <p>OM 442 LA M.B. 970-973, 975, 976, 978, 979-991</p> <p>OM 442 LA M.B. 951, 953, 980, 982, 983, 985, 989, 992-998</p> <p>OM 442 LA M.B. 920, 922, 924-927, 929-932, 935, 936, 938, 939</p> <p>OM 443 A M.B. 940, 980</p> <p>OM 352 OM 355</p>
35434	016 997 8248	Size: 30,8 x 3,7 FPM green OM 352 OM 355

● Sealing washer, copper/various

dph-no.	OEM-no.	application
47840	007603 006106	Size: 6 x 10 x 1
6841		Size: 6 x 12x x 1
109996 47847	007603 008100 007603 008109	Size: 8 x 11,5 x 1
47844	007603 008103	Size: 8 x 12 x 1
47850	007603 010103	Size: 10 x 14 x 1
34545	007603 012111	Size: 12 x 15,5 x 1,5
47858	007603 012110 007603 012113	Size: 12 x 17 x 1,5
34546	007603 014102	Size: 14 x 18 x 1,5
97948 34547	007603 016401 007603 016105	Size: 16 x 20 x 1,5
47887	007603 016103	Size: 16 x 22 x 1,5
47891	007603 017102	Size: 17 x 21 x 1,5
37245	007603 018101	Size: 18 x 22 x 1,5
47899	007603 020103	Size: 20 x 26 x 1,5
47905 32869	007603 022102 007603 22103	Size: 22 x 27 x 1,5
37288		Size: 22 x 28 x 1,5

● Sealing washer, aluminium/various

dph-no.	OEM-no.	application
93754	007603 006101	Size: 6 x 10 x 1
47843	007603 008101	Size: 8 x 12 x 1
47845	007603 008105	Size: 8 x 14 x 1
47859	007603 012112	Size: 12 x 15,5 x 1,5
33739	007603 014104	Size: 14 x 20 x 1,5
80833	007603 016100	Size: 16 x 20 x 1,5

Sealing washer, aluminium/various

dph-no.	OEM-no.	application
47886	007603 016102	Size: 16 x 22 x 1,5
32870	007603 018100	Size: 18 x 22 x 1,5
109992	007603 020100	Size: 20 x 24 x 1,5
34548	007603 022100	Size: 22 x 27 x 1,5
109993	007603 022104	Size: 22 x 29 x 1,5
34963	007603 024105	Size: 24 x 29 x 1,5
81080	007603 026106	Size: 26 x 31 x 2
109994	007603 026100	Size: 26 x 32 x 2
109995	007603 027101	Size: 27 x 32 x 2

O-ring/seal ring – engine/fuel-/oil filter

dph-no.	OEM-no.	application
4556	000 184 65 80	 <p>For oil filter, Size: 115 x 5,1 NBR 70</p> <p>OM 314 Up to engine -492711 From engine 492711 All engine types 40-63kW Diesel cyl. 97dia.</p> <p>OM 327 914-917/919/921-946 Diesel cyl. 115 dia</p> <p>OM 346 Up to engine 027399 910-919/940-947/951-953 154kW Diesel cyl. 128 All engine types</p> <p>OM 352 A up to engine 760548 OM 352 A from engine 760549 352 all, 353 all 96-127kW Diesel cyl. 97 dia</p> <p>OM 352 up to engine 760548 OM 352 from engine 760548 352 all, 353 all 74-96kW Diesel cyl. 97 dia OM 355, OM 355A/LA All engine types 136-207kW Diesel cyl. 128 dia</p> <p>OM 360 910/914-918/930/931/933/935-944/ 946/948-952/960-973/975/979/980/ 981/983 125-141kW Diesel cyl. 115 dia.</p> <p>OM 360 H 911/912/934/947/954-956/959/974/ 976-978 horizontal engine 125/141kW Diesel cyl. 115 dia.</p> <p>MB Trac 1000 /441,162 - 1100 /441,163 - 1300 / 443,163 - 1400 /443,164 - 1600 /443,166</p> <p>OM 366 M.B. 366: 908/912</p> <p>OM 366 A M.B. 366: 954/958/977 74-115kW Diesel cyl. 97,5 dia.</p> <p>Unimog U900, U1000, U1150, U1200, U1250, U1350, U1400, U1450, U1550, U1600, U1650, U1700, U1750, U2100, U2150</p>

O-ring/seal ring – engine/fuel-/oil filter

dph-no.	OEM-no.	application
6532	006 997 25 48	 <p>For oil filter, Size: 101 x 4,3 NBR 70</p> <p>OM 314 Up to engine -492711 From engine 492711 All engine types 40-63kW Diesel cyl. 97dia.</p> <p>OM 352 A up to engine 760548 OM 352 A from engine 760549 352 all, 353 all 96-127kW Diesel cyl. 97 dia</p> <p>OM 352 up to engine 760548 OM 352 from engine 760548 352 all, 353 all 74-96kW Diesel cyl. 97 dia</p> <p>OM 364 906/907/912/918/919/921 OM 364 A 950/952/957/958 OM 364 LA 981/986 63-100kW Diesel cyl. 97,5 dia.</p> <p>OM 366 M.B. 356: 901/902/904/905/908/910/911/913 M.B. 366: 905-907/909/910/914/917/919/930/ 932/933/936/938/940 OM 366 A M.B. 356: 940/943/944/946/948/951/953 M.B. 366: 941-943/945/946/951-953/957/962/ 965/967-971/973 OM 366 LA M.B. 356: 984/987 M.B. 366: 980/981/983/988/990/993/995-997 95-150kW Diesel cyl. 97,5 OM 366 M.B. 346: 903/909 M.B. 366: 918/931/937 OM 366 A M.B. 356: 941/945/947/952 M.B. 366: 944/966/974/976/978/979 OM 366LA M.B. 356: 985/986/990/992/994/995 M.B.: 366: 992/994 95-150kW Diesel cyl. 97,5 OM 366 LA M.B. 356: 979/983/989/991/996/999 M.B. 366: 901/999</p> <p>MB Trac 65, 70 /440 MB Trac 700, 800, 900 /440 40-63kW Diesel cyl. 97dia.</p> <p>MB Trac 700, 800, 900 /440 50-66kW Diesel cyl. 97,5 dia.</p> <p>MB Trac 65, 70 /440 700, 800, 900 /440 OM 314 up to engine 492711 MB 314: 956/957 OM 314 A up to engine 492711 MB 314: 970 48-63 kW Diesel cyl. 97 dia.</p> <p>MB Trac 65, 70 / 440 700, 800, 900 / 440 OM 314 from engine 492712 MB: 314: 956/957 OM 314 from engine 492712 MB 314: 970 48-63kW Diesel cy. 97 dia</p> <p>MB Trac 700, 800, 900 / 440 OM 364: 908, 909 OM 364: 951 50-66kW Diesel cyl. 97,5 dia.</p> <p>MB Trac 1000 /441 1100 /442, 443 OM 352 up to engine 760548 M.B. 353: 936/949/985 70-81kW Diesel cyl. 97 dia.</p> <p>MB Trac 1000 /441 1100 /442, 443 OM 352 from engine 760549 M.B. 353: 936/949/985 70-81kW Diesel cyl. 97 dia.</p> <p>MB Trac 1000 /441,162 1100 /441,163 1300 /443,163 1400 /443,164 1600 /443,166 OM 366 M.B. 366: 908/912 OM 366 A M.B.: 366: 954/958/977 74-115kW Diesel cyl. 97,5 dia.</p> <p>Unimog U900, U1000, U1150, U1200, U1250, U1350, U1400, U1450, U1550, U1600, U1650, U1700, U1750, U2100, U2150</p>

O-ring/seal ring – engine/fuel-/oil filter

dph-no. OEM-no. application

6513 000 477 31 80
6572 000 477 23 80



Size: 95 x 103 x 3 NBR 80

OM 401

M.B. 401: 900/901/905-909/912-916/918/919/921-928
 6 cyl. V-motor
 129-144kW Diesel cyl. 125 dia

OM 401 LA Euro I

970/972-974/977-981
 6 cyl. V-motor
 213-230kW Diesel cyl. 125 dia

OM 402

900/901/905-907/910-914/916/917/919/921/923-928
 8cyl. V-motor, 2 pcs required
 147-188kW Diesel cyl. 125 dia

OM 402 LA Euro I

970-973/975, 2 pcs. required
 8 cyl. V-motor 280kW Diesel cyl. 125 dia.

OM 403

900/905/906/910/911/915-919/930-935
 10 cyl. V-motor, 2 pcs required
 184-261kW Diesel cyl. 125 dia

OM 421

900/905-908/910
 OM 421 A/LA
 901/951
 6 cyl. V-motor
 159-184kW Diesel cyl. 128 dia.

OM 422

900/905-915/917-923
 8 cyl. V-motor
 184/206kW Diesel cyl. 128 dia.

OM 422

900/905-915/917-923

OM 422 A/LA

901/951-959-963
 8 cyl. V-motor
 184-276kW Diesel cyl. 128 dia.
 2 pcs required

OM 423

900/905-909
OM 423 A/LA
 901/950
 10 cyl. V-motor
 261-368kW Diesel cyl. 128 dia
 2 pcs required

OM 441

900/905-909/911-921/923-937
 150-165kW

OM 441 Euro I

900/922/932/933
 151kW
 6 cyl. V-motor Diesel cyl. 128/130 dia.

OM 441 A / OM 441 LA

901/950/951/953/960-962/985
 200-250kW

OM 441 A Euro I, OM 441 LA Euro I

901/980-983/986-990/992/994
 250kW
 6 cyl. V-motor Diesel cyl. 128/130 dia.

OM 442

900/905-911/914-930/932-935/939
 191-218kW

OM 442 Euro I

900/931
 195kW
 8 cyl. V-motor Diesel cyl. 128/130 dia.
 2 pcs required

OM 442 A / OM 442 LA

901/941-946/950-955/957-968/976/978/980/982/
 983/985/989/992-994
 269-362kW

OM 442 A Euro I / OM 442 LA Euro I

940-942/972-973
 250-370kW
 8 cyl. V-motor Diesel cyl. 128/130 dia.
 2 pcs required

OM 443

900/905
 271kW
OM 443A, OM 443 LA
 901/940/980
 340-412kW
OM 443 LA Euro I
 901-504
 10 cyl. V-motor Diesel cyl. 128 dia.

4564 000 477 35 80



Size: 75 x 81,4 x 3 NBR 80

For fuel filter, 2 pcs required

OM 314

Up to engine -492711
 From engine 492711
 All engine types 40-63kW
 Diesel cyl. 97dia.

OM 352 A up to engine 760548

OM 352 A from engine 760549
 352 all, 353 all
 96-127kW Diesel cyl. 97 dia

OM 352 up to engine 760548

OM 352 from engine 760548
 352 all, 353 all
 74-96kW Diesel cyl. 97 dia

OM 360

910/914-918/930/931/933/935-944/
 946/948-952/960-973/975/979/980/
 981/983
 125-141kW Diesel cyl. 115 dia.

OM 360 A

154kW Diesel cyl. 115 dia.

OM 362 LA

906/909/910
 141kW Diesel cyl. 97 dia.

OM 364

906/907/912/918/919/921

OM 364 A

950/952/957/958

OM 364 LA

981/986
 63-100kW Diesel cyl. 97,5 dia.

O-ring/seal ring – engine/fuel-/oil filter

dph-no.	OEM-no.	application
		<p>OM 366 M.B. 356: 901/902/904/905/908/910/911/913 M.B. 366: 905-907/909/910/914/917/919/930/932/933/936/938/940</p> <p>OM 366 A M.B. 356: 940/943/944/946/948/951/953 M.B. 366: 941-943/945/946/951-953/957/962/965/967-971/973</p> <p>OM 366 LA M.B. 356: 984/987 M.B. 366: 980/981/983/988/990/993/995-997 95-150kW Diesel cyl. 97,5</p> <p>OM 366 M.B. 346: 903/909 M.B. 366: 918/931/937</p> <p>OM 366 A M.B. 356: 941/945/947/952 M.B. 366: 944/966/974/976/978/979</p> <p>OM 366LA M.B. 356: 985/986/990/992/994/995 M.B. 366: 992/994 95-150kW Diesel cyl. 97,5</p> <p>OM 366 LA M.B. 356: 979/983/989/991/996/999 M.B. 366: 901/999</p> <p>OM 401 M.B. 401: 900/901/905-909/912-916/918/919/921-928 6 cyl. V-motor 129-144kW Diesel cyl. 125 dia</p> <p>OM 402 900/901/905-907/910-914/916/917/919/921/923-928 8cyl. V-motor, 2 pcs required 147-188kW Diesel cyl. 125 dia</p> <p>OM 403 900/905/906/910/911/915-919/930-935 10 cyl. V-motor, 2 pcs required 184-261kW Diesel cyl. 125 dia</p> <p>OM 422 900/905-915/917-923 8 cyl. V-motor 184/206kW Diesel cyl. 128 dia.</p> <p>OM 422 900/905-915/917-923</p> <p>OM 422 A/LA 901/951-959-963 8 cyl. V-motor 184-276kW Diesel cyl. 128 dia. 2 pcs required</p> <p>MB Trac 65, 70 /440 MB Trac 700, 800, 900 /440 40-63kW Diesel cyl. 97dia.</p>
		<p>MB Trac 700, 800, 900 /440 50-66kW Diesel cyl. 97,5 dia.</p> <p>MB Trac 65, 70 /440 700, 800, 900 /440 OM 314 up to engine 492711 MB 314: 956/957 OM 314 A up to engine 492711 MB 314: 970 48-63 kW Diesel cyl. 97 dia.</p> <p>MB Trac 65, 70 / 440 700, 800, 900 / 440 OM 314 from engine 492712 MB: 314: 956/957 OM 314 from engine 492712 MB 314: 970 48-63kW Diesel cy. 97 dia</p> <p>MB Trac 700, 800, 900 / 440 OM 364: 908, 909 OM 364: 951 50-66kW Diesel cyl. 97,5 dia.</p> <p>MB Trac 1000 /441 1100 /442, 443 OM 352 up to engine 760548 M.B. 353: 936/949/985 70-81kW Diesel cyl. 97 dia.</p> <p>MB Trac 1000 /441 1100 /442, 443 OM 352 from engine 760549 M.B. 353: 936/949/985 70-81kW Diesel cyl. 97 dia.</p> <p>MB Trac 1000 /441,162 1100 /441,163 1300 /443,163 1400 /443,164 1600 /443,166</p> <p>OM 366 M.B. 366: 908/912</p> <p>OM 366 A M.B. 366: 954/958/977 74-115kW Diesel cyl. 97,5 dia.</p> <p>Unimog U900, U1000, U1150, U1200, U1250, U1350, U1400, U1450, U1550, U1600, U1650, U1700, U1750, U2100, U2150</p>
82207	000 184 31 80	 <p>OM 322 910- 919/970/971 Diesel cyl. 97 dia.</p> <p>Size: 126 x 5 NBR 70</p> <p>For oil filter</p>

O-ring/seal ring – engin/fuel-/oil filter

dph-no.	OEM-no.	application
4556	000 184 65 80	 <p>OM 327 914-917/919/921-946 Diesel cyl. 115 dia</p> <p>Size: 115 x 5,1 NBR 70</p>
4560	008 997 70 45	 <p>Size: 134 x 4 NBR 70</p> <p>OM 401 M.B. 401: 900/901/905-909/912-916/918/919/921-928 6 cyl. V-motor 129-144kW Diesel cyl. 125 dia</p> <p>OM 401 A 917 6 cyl. V-motor 188kW Diesel cyl. 125 dia.</p> <p>OM 401 LA Euro I 970/972-974/977-981 6 cyl. V-motor 213-230kW Diesel cyl. 125 dia</p> <p>OM 402 900/901/905-907/910-914/916/917/919/921/923-928 8cyl. V-motor 147-188kW Diesel cyl. 125 dia</p> <p>OM 402 LA Euro I 970-973/975 8 cyl. V-motor 280kW Diesel cyl. 125 dia.</p> <p>OM 403 900/905/906/910/911/915-919/930-935 10 cyl. V-motor 184-261kW Diesel cyl. 125 dia</p> <p>OM 407 / OM407 A, LA, H, HA 900/901/905/907-911/913-920/925/951/955 6 cyl. In-line engine 132-206kW Diesel cyl. 125 dia.</p> <p>OM 409 901 5 cyl. Diesel in-line engine cyl. 125 dia.</p> <p>OM 421 900/905-908/910 OM 421 A/LA 901/951 6 cyl. V-motor 159-184kW Diesel cyl. 128 dia.</p> <p>OM 422 900/905-915/917-923 8 cyl. V-motor 184/206kW Diesel cyl. 128 dia.</p> <p>OM 422 900/905-915/917-923 OM 422 A/LA 901/951-959-963 8 cyl. V-motor 184-276kW Diesel cyl. 128 dia.</p> <p>OM 423 900/905-909 OM 423 A/LA 901/950 10 cyl. V-motor 261-368kW Diesel cyl. 128 dia</p> <p>OM 427, OM 427 H 900/901/905/910/911 OM 427A / LA OM 427 HA 902/903/950/951/952 6 cylinder in-line engine 150-206kW Diesel cyl. 128 dia</p> <p>OM 441 900/905-909/911-921/923-937 150-165kW</p> <p>OM 441 Euro I 900/922/932/933 151kW 6 cyl. V-motor Diesel cyl. 128/130 dia.</p> <p>OM 441 A / OM 441 LA 901/950/951/953/960-962/985 200-250kW</p> <p>OM 441 A Euro I, OM 441 LA Euro I 901/980-983/986-990/992/994 250kW 6 cyl. V-motor Diesel cyl. 128/130 dia.</p> <p>OM 442 900/905-911/914-930/932-935/939 191-218kW</p> <p>OM 442 Euro I 900/931 195kW 8 cyl. V-motor Diesel cyl. 128/130 dia.</p> <p>OM 442 A / OM 442 LA 901/941-946/950-955/957-968/976/978/980/982/983/ 985/989/992-994 269-362kW</p> <p>OM 442 A Euro I / OM 442 LA Euro I 940-942/972-973 250-370kW 8 cyl. V-motor Diesel cyl. 128/130 dia.</p> <p>OM 443 900/905 271kW</p> <p>OM 443A, OM 443 LA 901/940/980 340-412kW</p> <p>OM 443 LA Euro I 901-504 10 cyl. V-motor Diesel cyl. 128 dia.</p> <p>OM 444 A / OM 444 LA 901 12 cyl. V-motor Diesel cyl. 128 dia.</p>

● O-ring/seal ring – engine/fuel-/oil filter

dph-no.	OEM-no.	application
		OM 447 900 OM 447 Euro I 900-004 OM 447 H 901/905-908, 910-913 150-184kW OM 447 H Euro I 901-04/914 157kW OM 447 A, OM 447 LA 902 OM 447 A Euro I, OM 447 LA Euro I 902-404/902-504
		OM 447 HA, OM 447 HLA 903/950-953 206kW OM 447 HA Euro I / OM 447 HLA Euro I 903-604/903-704/956/957/959/981/982/984/986 184-220kW 6 cyl. In-line engine Diesel cyl. 128 dia.
		OM 457LA 265/280 kW, 6 cyl. Diesel
		OM 449 HLA 155-184 kW, 5 cyl. Diesel dia. 128

● O-ring/seal ring – engine

dph-no.	OEM-no.	application
34880	000 477 33 80	OM 409 901 5 cyl. Diesel in-line engine cyl. 125 dia. 2 pcs required
104091	541 011 00 59	OM 501 LA / OM 501 LA IMO Actros M.B: 521: 940 M.B: 541: 920-928 M.B: 941: 910/920/929/930/940/960/970/990 6 cyl. V-motor Diesel 230-315kW
81999	360 997 92 45	Size: 24,99 x 3,53 NBR 70
95814	422 144 02 80	Turbocharger
84300	422 997 00 40	Turbocharger
61041	346 017 02 60	Engine
33812	346 997 04 45	Engine
33410	000 997 00 40	All engine types
34012	008 997 61 45	Size: 7 x 3 FPM 70 OM 402 OM 403 OM 422/A OM 423
36614	007 997 34 48	OM 422/A
37079	013 997 96 48	OM 401 LA OM 402 LA OM 441 A OM 442 A OM 443 A OM 447 A
34312	006 997 49 48	Size: 60 x 8 MVQ 60 red OM 355 A

O-ring/seal ring – engine

dph-no.	OEM-no.	application
34311	006 997 48 48	Size: 45 x 8 MVQ 60 red OM 442A M.B. 951, 952, 954, 956-958.963 OM 422LA M.B. 953, 955, 959 OM 442A MB : 941-946, 950, 952, 954, 955, 957-959 OM 442 A Euro I MB: 940-942- 945 OM 442 LA MB: 951, 953, 960-968, 971, 972, 976, 980, 982, 983, 985, 989, 992-994 OM 442 LA Euro I MB: 970-973,975, 976, 978-987, 989-991, OM 442 LA Euro II MB: 920, 922, 924-936, 938, 939 OM 492
6733	000 094 26 80	1924/L/LA 26247
34994	000 094 25 80	1924/L/LA 2624

Gasket

dph-no.	OEM-no.	application
95855	442 492 00 80	 <p>OM 424, OM 424 A/LA 900/901 12 cyl. V-motor Diesel cyl. 128 dia. 2 pcs required</p> <p>OM 427, OM 427 H 900/901/905/910/911 OM 427A / LA OM 427 HA 902/903/950/951/952 6 cylinder in-line engine 150-206kW Diesel cyl. 128 dia.</p> <p>OM 441 900/905-909/911-921/923-937 150-165kW OM 441 Euro I 900/922/932/933 151kW 6 cyl. V-motor Diesel cyl. 128/130 dia. OM 441 A / OM 441 LA 901/950/951/953/960-962/985 200-250kW OM 441 A Euro I, OM 441 LA Euro I 901/980-983/986-990/992/994 250kW 6 cyl. V-motor Diesel cyl. 128/130 dia.</p> <p>OM 442 900/905-911/914-930/932-935/939 191-218kW OM 442 Euro I 900/931 195kW 8 cyl. V-motor Diesel cyl. 128/130 dia. OM 442 A / OM 442 LA 901/941-946/950-955/957-968/976/ 978/980/982/983/985/989/992-994 269-362kW OM 442 A Euro I / OM 442 LA Euro I 940-942/972-973 250-370kW 8 cyl. V-motor Diesel cyl. 128/130 dia.</p> <p>OM 360 910/914-918/930/931/933/935-944/946/948- 952/960-973/975/979/980/981/983 125-141kW Diesel cyl. 115 dia.</p> <p>OM 402 900/901/905-907/910-914/916/917/919/921/ 923-928 8cyl. V-motor 147-188kW Diesel cyl. 125 dia</p> <p>OM 403 900/905/906/910/911/915-919/930-935 10 cyl. V-motor 184-261kW Diesel cyl. 125 dia</p> <p>OM 407 / OM407 A, LA, H, HA 900/901/905/907-911/913-920/925/951/955 6 cyl. In-line engine 132-206kW Diesel cyl. 125 dia.</p> <p>OM 421 900/905-908/910 OM 421 A/LA 901/951 6 cyl. V-motor, 2 pcs required 159-184kW Diesel cyl. 128 dia.</p> <p>OM 422 900/905-915/917-923 8 cyl. V-motor 184/206kW Diesel cyl. 128 dia. OM 422 900/905-915/917-923 OM 422 A/LA 901/951-959-963 8 cyl. V-motor 184-276kW Diesel cyl. 128 dia., 2 pcs required</p>

Gasket

dph-no.	OEM-no.	application
95087	366 015 00 60	
82263	352 015 01 60	
<p>OM 366 LA M.B. 356: 984/987 M.B. 366: 980/981/983/988/990/993/995-997 95-150kW Diesel cyl. 97,5</p> <p>OM 366 M.B. 346: 903/909 M.B. 366: 918/931/937</p> <p>OM 366 A M.B. 356: 941/945/947/952 M.B. 366: 944/966/974/976/978/979</p> <p>OM 366LA M.B. 356: 985/986/990/992/994/995 M.B. 366: 992/994 95-150kW Diesel cyl. 97,5</p> <p>OM 366 LA M.B. 356: 979/983/989/991/996/999 M.B. 366: 901/999</p>		
<p>OM 366 M.B. 356: 901/902/904/905/908/910/911/913 M.B. 366: 905-907/909/910/914/917/919/930/932/933/936/938/940</p> <p>OM 366 A M.B. 356: 940/943/944/946/948/951/953 M.B. 366: 941-943/945/946/951-953/957/962/965/967-971/973</p>		





Gasket set

dph-no.	OEM-no.	application
61053	423 010 48 33	
<p>OM 401 M.B. 401: 900/901/905-909/912-916/918/919/921-928 6 cyl. V-motor 129-144kW Diesel cyl. 125 dia</p> <p>OM 401 A 917 6 cyl. V-motor 188kW Diesel cyl. 125 dia.</p> <p>OM 401 LA Euro I 970/972-974/977-981 6 cyl. V-motor 213-230kW Diesel cyl. 125 dia</p> <p>OM 402 900/901/905-907/910-914/916/917/919/921/923-928 8cyl. V-motor 147-188kW Diesel cyl. 125 dia.</p> <p>OM 402 LA Euro I 970-973/975 8 cyl. V-motor 280kW Diesel cyl. 125 dia</p> <p>OM 403 900/905/906/910/911/915-919/930-935 10 cyl. V-motor 184-261kW Diesel cyl. 125 dia</p> <p>OM 404, OM 404 A 900/901 12 cyl. V-motor Diesel cyl. 125 dia.</p> <p>OM 421 900/905-908/910 OM 421 A/LA 901/951 6 cyl. V-motor 159-184kW Diesel cyl. 128 dia.</p> <p>OM 422 900/905-915/917-923 8 cyl. V-motor 184/206kW Diesel cyl. 128 dia. OM 422 900/905-915/917-923</p> <p>OM 422 A/LA 901/951-959-963 8 cyl. V-motor 184-276kW Diesel cyl. 128 dia.</p> <p>OM 423 900/905-909 OM 423 A/LA 901/950 10 cyl. V-motor 261-368kW Diesel cyl. 128 dia</p> <p>OM 424, OM 424 A/LA 900/901 12 cyl. V-motor Diesel cyl. 128 dia.</p> <p>OM 441 900/905-909/911-921/923-937 150-165kW</p> <p>OM 441 Euro I 900/922/932/933 151kW 6 cyl. V-motor Diesel cyl. 128/130 dia.</p> <p>OM 441 A / OM 441 LA 901/950/951/953/960-962/985 200-250kW</p> <p>OM 441 A Euro I, OM 441 LA Euro I 901/980-983/986-990/992/994 250kW 6 cyl. V-motor Diesel cyl. 128/130 dia.</p> <p>OM 442 900/905-911/914-930/932-935/939 191-218kW</p> <p>OM 442 Euro I 900/931 195kW 8 cyl. V-motor Diesel cyl. 128/130 dia.</p> <p>OM 442 A / OM 442 LA 901/941-946/950-955/957-968/976/978/980/982/983/985/989/992-994 269-362kW</p> <p>OM 442 A Euro I / OM 442 LA Euro I 940-942/972-973 250-370kW 8 cyl. V-motor Diesel cyl. 128/130 dia.</p> <p>OM 442 900/905 271kW</p> <p>OM 443A, OM 443 LA 901/940/980 340-412kW</p> <p>OM 443 LA Euro I 901-504 10 cyl. V-motor Diesel cyl. 128 dia.</p> <p>OM 444 A / OM 444 LA 901 12 cyl. V-motor Diesel cyl. 128 dia.</p>		







Gasket for steering

dph-no.	OEM-no.	application
98705	541 010 09 33	 <p>OM 501 LA / OM 501 LA IMO Actros M.B: 521: 940 M.B: 541: 920-928 M.B: 941: 910/920/929/930/940/960/970/990 6 cyl. V-motor Diesel 230-315kW</p> <p>OM 502 LA Actros 8 cyl. V-engine 350-420 kw Diesel</p>

Gasket/engine

dph-no.	OEM-no.	application
80038	442 011 00 59	 <p>Tombac-ring For cylinder liner</p>
97117	442 011 00 80	 <p>Engine</p>
95529	442 011 02 59	For cylinder liner - shim
95905	442 098 09 80	 <p>Material: rubber/metal</p>
95907	442 098 10 80	 <p>Material: rubber/metal</p>
68588	442 131 00 80	 <p>Engine</p>







Gasket/engine

dph-no.	OEM-no.	application
70274	442 131 01 80	
84782	442 131 09 80	
37561	442 141 04 80	
95908	442 141 09 80	Material: rubber/metal
81775	442 184 04 80	 For oil filter
81776	442 184 05 80	 For oil filter
95817	442 187 00 80	 Engine

Gasket/engine

dph-no.	OEM-no.	application	
95818	442 187 01 80		Engine
61061	442 188 05 80		Oil filter
80783	442 201 10 80		Water pump
37159 4296	442 074 00 59 403 074 00 59		Seal ring, injection pump to crankcase OM 401, 402, 421, 422, 423, 424, 443, 444 A / LA OM 403 OM 404 A OM 441 A/LA Euro I+II OM 442 A/LA Euro I+II
95815	442 018 00 80		
82292	352 076 02 80		Injection
80260	352 997 05 40		Injection Material: rubber

● Gasket/engine

dph-no.	OEM-no.	application	
95252	355 188 00 80		Oil cooler
68591	355 203 00 80		Thermostat
97128	355 997 00 49		Water pump
95909	366 188 08 80		Engine
3993	407 131 05 80		Engine
33745	346 017 01 60		OM 401, OM 402, OM 403, OM 421, OM 422, OM 423, OM 441, OM 442, OM 443
81893	403 016 00 61		

Valve

dph-no.	OEM-no.	application
94069	423 050 00 26	
94070	423 050 04 28	

Valve guide

dph-no.	OEM-no.	application
110774	312 053 02 30	LP 608, 709, 808 ,809, 811, 911 Inner dia. 9,0 mm Outer dia 15,0 mm
109534	352 053 16 30	Inner dia. 10,0 mm Outer dia. 15,03 mm
109535	352 053 37 30	Inner dia. 10,0 mm Outer dia. 15,0 mm LK/LN2 1114 (since 03/84), 1117, 1120, 1314, 1317, 1320, 709, 809, 814, 914 NG 1417
109536	360 053 00 30	Inner dia. 10,0 mm Outer dia. 16,0 mm
109537	422 053 04 30	Exhaust/intake Inner dia. 12,0 mm Outer dia. 18,0 mm
109538	352 053 22 29	Inner dia. 9,0 mm Outer dia. 15,0 mm



Valve guide

dph-no.	OEM-no.	application
109539	360 053 00 29	 <p>Inner dia. 10,0 mm Outer dia. 16,04 mm</p>

Oil seal crankshaft

dph-no.	OEM-no.	application
94506	315 030 00 80	 <p>Size: 24 x 25 x 10 OM 327 914-917/919/921-946, Diesel cyl. 115 dia OM 346 up to engine 027399 910-919/940-947/951-953 154kW, Diesel 128 cyl. Dia. OM 355, OM 355A/LA 136-207kW Diesel cyl. 128 dia All engine types, crankshaft rear</p>
37088 36222 47592 47594 47381 47662 47025 47512 47515	014 997 46 47 012 997 74 47 006 997 16 47 006 997 23 47 011 997 13 46 009 997 34 47 005 997 51 46 003 997 07 47 003 997 13 47	 <p>Size: 105 x 130 x 12 FPM AB/BS RD</p> <p>OM 401 M.B. 401: 900/901/905-909/912-916/918/919/ 921-928 6 cyl. V-motor 129-144kW Diesel cyl. 125 dia</p> <p>OM 401 A 917 6 cyl. V-motor 188kW Diesel cyl. 125 dia.</p> <p>OM 401 LA Euro I 970/972-974/977-981 6 cyl. V-motor 213-230kW Diesel cyl. 125 dia</p> <p>OM 402 900/901/905-907/910-914/916/917/919/921/ 923-928 8cyl. V-motor 147-188kW Diesel cyl. 125 dia</p> <p>OM 402 LA Euro I 970-973/975 8 cyl. V-motor 280kW Diesel cyl. 125 dia.</p> <p>OM 403 900/905/906/910/911/915-919/930-935 10 cyl. V-motor 184-261kW Diesel cyl. 125 dia</p> <p>OM 407 / OM407 A, LA, H, HA 900/901/905/907-911/913-920/925/951/955 6 cyl. In-line engine 132-206kW Diesel cyl. 125 dia.</p> <p>OM 501 LA / OM 501 LA IMO Actros M.B: 521: 940 M.B: 541: 920-928 M.B: 941: 910/920/929/930/940/960/970/990 6 cyl. V-motor Diesel 230-315kW</p> <p>OM 502 LA Actros 8 cyl. V-engine 350-420 kw Diesel 8 pcs required</p> <p>OM 449 HLA 155-184 kW, 5 cyl. Diesel dia. 128</p> <p>OM 457 LA/LAIII, HLA, HLAIII 6 cyl. 185-335 kW</p>

Oil seal crankshaft

dph-no.	OEM-no.	application
36223	013 997 14 47 optional with 014 997 13 47	 <p>Size: 120 x 140 x 13 FPM AW/BS LD</p> <p>Crankshaft rear OM 501 LA / OM 501 LA IMO Actros M.B: 521: 940 M.B: 541: 920-928 M.B: 941: 910/920/929/930/940/960/970/990 6 cyl. V-motor Diesel 230-315kW</p> <p>OM 502 LA Actros 8 cyl. V-engine 350-420 kw Diesel 8 pcs required</p>
104349	014 997 46 48	
47419	403 997 01 46	
		OM 401 A/LA OM 402 A/LA OM 403 OM 404/a OM 407 H/A/LA/HA OM 421 A/LA OM 422 A/LA OM 423 A/LA OM 424 A/LA OM 427 H/A/LA/HA OM 441 A/LA OM 442 A/LA OM 443 A/LA OM 444 A/LA OM 447 H/A/LA/HA/HLA OM 449 HLA 155-184 kW, 5 cyl. Diesel dia. 128 OM 404, OM 404 A 900/901 12 cyl. V-motor Diesel cyl. 125 dia. OM 457 LA/LAIII, HLA, HLAIII 6 cyl. 185-335 kW
47737	016 997 08 47	 <p>Size: 120 x 140 x 13 AW/BS LD FPM</p> <p>Crankshaft OM 402</p>

Clutch, gearbox

Clutch servo cylinder

dph-no.	OEM-no.	application	
81311	001 295 67 07		Wabco 970 051 1310 Repair kit: dph 82066 NG 1628, 1633, 1638, 1922, 1928, 1933, 1935, 1936, 1938, 1944, 2033, 2228, 2233, 2238, 2633 SK 1922, 1935
109397	000 295 00 18		Wabco 970 051 13 70 Repair kit: 82067 OM 442

Repair kit clutch servo

dph-no.	OEM-no.	application	
82066	000 290 06 67		Wabco 970 051 9032
82067			Wabco 970 051 9102
81894	000 290 32 67		

Transmission

dph-no.	OEM-no.	application
37568	000 586 18 26	 <p>Repair kit Gear shift lever Atego 1/1517, Atego II/2628 Econic 2628 LK/LN2 1517 NG 1624, 1928, 2628</p>
98567	000 267 17 15	





Transmission oil seal

dph-no.	OEM-no.	application
47306	008 997 73 46	 <p>Steering ZF 0634 300 355 Size: 30 x 40 x 7 NBR B blue</p>
47434	000 997 11 47	 <p>Steering ZF 0634 302 460 Size: 32 x 45 x 7 NBR A</p>
47240	006 997 49 46	 <p>Steering ZF 0634 300 302 Size: 25 x 35 x 7 NBR B</p>
47385	011 997 22 46	 <p>Steering ZF 0634 300 020 Size: 25 x 32 x 5 B OF NBR</p>
95501		ZF 0634 301 302 25 x 33 x 6

● Transmission oil seal

dph-no.	OEM-no.	application
46980	003 997 98 46	 <p>ZF 0634 300 185 Size: 10 x 15 x 3 NBR BO</p>
6440	003 997 00 40	 <p>ZF 0634 307 405 30x40x7/10</p>

● Transmission seal ring

dph-no.	OEM-no.	application
80962	0634 314 018	 <p>16 S 130 16 S 160 Size: 59 x 2 FPM 80</p>
80963	0634 314 019	 <p>16 S 130 16 S 160 Size: 94 x 3 FPM 80</p>
80964	0634 314 020	 <p>16 S 130 16 S 160 Size: 8 x 2 FPM 80</p>
95686	0750 112 066	 <p>16 S 130 16 S 160 Size: 85 x 5,6</p>

Brake parts

Diaphragm/brake part

dph-no.	OEM-no.	application	
82977	000 421 20 86		Flat type T 24
82978	000 421 29 86		T 16
82979	000 423 12 86		Deep type T 30
81625	897 120 51 64		16"
84630	897 120 52 04		20"
81624	897 120 53 64		24"

Diaphragm/brake part

dph-no.	OEM-no.	application
81623	897 120 54 64	 <p>30"</p>
81626	897 120 52 64	 <p>20"</p>
82980	000 431 07 28	 <p>T 20</p>

Washer/rear axle

dph-no.	OEM-no.	application
37646	007603 024106	 <p>Size: 24x29x2 copper</p>
37645	007603 045100	 <p>Size: 45x52x2 ALU</p>

Oil seal crankshaft

dph-no.	OEM-no.	application
47669	009 997 77 47	 <p>Crankshaft front</p> <p>OM 314 –motor 492711 All engine types 40-63kW Diesel cyl. 97dia.</p> <p>OM 322 910-919/970/971 Diesel cyl. 97 dia</p> <p>OM 352 A up to engine 598249 352 all, 353 all 96-127kW, Diesel cyl. 97 dia</p> <p>OM 352 up to engine 598249 352 all, 353 all 74-96kW, Diesel cyl. 97 dia</p> <p>Size: 65 x 90 x 15 B RD FPM (dph 47957)</p> <p>Size: 65 x 90 x 15 MVQ B RD white (dph 51726)</p>

Oil seal crankshaft

dph-no.	OEM-no.	application
---------	---------	-------------

47604	006 997 85 47	
47669	009 997 77 47	
47673	009 997 94 47	
82131	014 997 16 47	



Size: 65 x 90 x 13 FPM AW/BS RD

Crankshaft front

OM 314 –motor 492711

All engine types 40-63kW
Diesel cyl. 97dia.

OM 322

910-919/970/071

Diesel cyl. 97 dia.

OM 352 A up to engine 760548

352 all, 353 all

96-127kW, Diesel cyl. 97 dia

OM 352 up to engine 598249

352 all, 353 all

74-96kW, Diesel cyl. 97 dia

MB Trac

1000 /441

1100 /442, 443

OM 352 up to engine 760548

M.B. 353: 936/949/985

70-81kW Diesel cyl. 97 dia.

Up to engine 598249

OM 314 –motor 492711

Diesel cyl. 97dia.

Up to engine 369095

OM 352 A up to engine 760548

(from engine 598250)

OM 352 A from engine 760549

352 all, 353 all

96-127kW Diesel cyl. 97 dia

OM 352 up to engine 760548 (from engine 598250)

OM 352 from engine 760548

352 all, 353 all

74-96kW Diesel cyl. 97 dia.

OM 362 LA

906/909/910

141kW Diesel cyl. 97 dia.

OM 364

906/907/912/918/919/921

OM 364 A

950/952/957/958

OM 364 LA

981/986

63-100kW Diesel cyl. 97,5 dia.

OM 366

M.B. 356: 901/902/904/905/908/910/911/913

M.B. 366: 905-907/909/910/914/917/919/930/

932/933/936/938/940

OM 366 A

M.B. 356: 940/943/944/946/948/951/953

MB. 366: 941-943/945/946/951-953/957/962/

965/967-971/973

OM 366 LA

M.B. 356: 984/987

M.B. 366: 980/981/983/988/990/993/

995-997

95-150kW Diesel cyl. 97,5

OM 366

M.B. 346: 903/909

M.B. 366: 918/931/937

OM 366 A

M.B. 356: 941/945/947/952

M.B. 366: 944/966/974/976/978/979

OM 366LA

M.B. 356: 985/986/990/992/994/995

M.B. 366: 992/994

95-150kW Diesel cyl. 97,5

OM 366 LA

M.B. 356: 979/983/989/991/996/999

M.B. 366: 901/999

MB Trac 65, 70 /440

MB Trac 700, 800, 900 /440

40-63kW

Diesel cyl. 97dia.

MB Trac 65, 70 / 440

700, 800, 900 / 440

OM 314 from engine 492712

MB: 314: 956/957

OM 314 from engine 492712

MB 314: 970

48-63kW Diesel cy. 97 dia

MB Trac 700, 800, 900 / 440

OM 364: 908, 909

OM 364: 951

50-66kW Diesel cyl. 97,5 dia.

MB Trac

1000 /441

1100 /442, 443

OM 352 up to engine 760548

M.B. 353: 936/949/985

70-81kW Diesel cyl. 97 dia.

From engine 5982502

MB Trac

1000 /441

1100 /442, 443

OM 352 from engine 760549

M.B. 353: 936/949/985

70-81kW Diesel cyl. 97 dia.

MB Trac

1000 /441,162

1100 /441,163

1300 /443,163

1400 /443,164

1600 /443,166

OM 366

M.B. 366: 908/912

OM 366 A

M.B. 366: 954/958/977

74-115kW Diesel cyl. 97,5 dia.

Unimog

U900, U1000, U1150, U1200, U1250,

U1350, U1400, U1450, U1550, U1600,

U1650, U1700, U1750, U2100, U2150

Oil seal crankshaft

dph-no.	OEM-no.	application
48261	000 997 96 41	 <p>Crankshaft rear, 2 pcs required</p> <p>OM 314 –motor 492711 From engine 369096 Diesel cyl. 97dia.</p> <p>OM 352 A up to engine 760548 OM 352 A from engine 760549 352 all, 353 all 96-127kW Diesel cyl. 97 dia OM 352 up to engine 760548 OM 352 from engine 760548 352 all, 353 all 74-96kW Diesel cyl. 97 dia OM 362 LA 906/909/910 141kW Diesel cyl. 97 dia.</p> <p>OM 366 LA M.B. 356: 979/983/989/991/996/999 M.B. 366: 901/999</p> <p>MB Trac 65, 70 /440 MB Trac 700, 800, 900 /440 40-63kW Diesel cyl. 97dia.</p> <p>MB Trac 65, 70 /440 700, 800, 900 /440 OM 314 up to engine 492711 MB 314: 956/957 OM 314 A up to engine 492711 MB 314: 970 48-64 kW Diesel cyl. 97 dia.</p> <p>MB Trac 65, 70 / 440 700, 800, 900 / 440 OM 314 from engine 492712 MB: 314: 956/957 OM 314 from engine 492712 MB 314: 970 48-63kW Diesel cy. 97 dia</p> <p>MB Trac 1000 /441 1100 /442, 443 OM 352 from engine 760549 M.B. 353: 936/949/985 70-81kW Diesel cyl. 97 dia.</p>
36221 47522	011 997 57 47 003 997 45 47	 <p>Size: 75 x 100 x 12/13 FPM BS RD</p> <p>Crankshaft front - Size:</p> <p>OM 327 914-917/919/921-946 Diesel cyl. 115 dia</p> <p>OM 346 Up to engine 027399 910-919/940-947/951-953 154 kW Diesel cyl. 128 dia. All engine types</p> <p>OM 355, OM 355A/LA All engine types 136-207kW Diesel cyl. 128 dia</p> <p>OM 360 910/914-918/930/931/933/935-944/ 946/948-952/960-973/975/979/980/ 981/983 125-141kW Diesel cyl. 115 dia. OM 360 A 154kW Diesel cyl. 115 dia. OM 360 H 911/912/934/947/954-956/959/974/ 976-978 horizontal engine 125/141kW Diesel cyl. 115 dia.</p>
36216 46971 47335	004 997 93 47 003 997 67 46 009 997 51 46	 <p>Size: 125 x 160 x 18 FPM BS LD</p> <p>OM 327 M.B. 327: 914/915/916/917/919/921-946 Cyl. 115 dia, Diesel</p> <p>OM 360 M.B. 360: 910/914-918, 930/931/933/ 935-944/946/948-952/960-973/975/ 979/980/981/983 125-141kW, Diesel Cyl. 115 dia</p> <p>OM 360 A MB: 982 154kW, Diesel, cyl. 115 dia.</p> <p>OM 360 H M.B. 360: 911/912/934/947/954-956/ 959/974/976-978 Horizontal engine 125/141kW Diesel cyl. 115 dia.</p>

Oil seal crankshaft

dph-no. OEM-no. application

94963 001 997 41 41



OM 364

906/907/912/918/919/921

OM 364 A

950/952/957/958

OM 364 LA

981/986

63-100kW Diesel cyl. 97,5 dia.

2 pcs required

OM 366

M.B. 356: 901/902/904/905/908/910/911/913

M.B. 366: 905-907/909/910/914/917/919/930/
932/933/936/938/940

OM 366 A

M.B. 356: 940/943/944/946/948/951/953

M.B. 366: 941-943/945/946/951-953/957/962/
965/967-971/973

OM 366 LA

M.B. 356: 984/987

M.B. 366: 980/981/983/988/990/993/995-997

95-150kW Diesel cyl. 97,5

OM 366

M.B. 346: 903/909

M.B. 366: 918/931/937

OM 366 A

M.B. 356: 941/945/947/952

M.B. 366: 944/966/974/976/978/979

OM 366LA

M.B. 356: 985/986/990/992/994/995

M.B. 366: 992/994

95-150kW Diesel cyl. 97,5

2 pc required

MB Trac 65, 70 /440

MB Trac 700, 800, 900 /440

40-63kW

Diesel cyl. 97dia.

2 pcs required

MB Trac

65, 70 /440

700, 800, 900 /440

OM 314 up to engine 492711

MB 314: 956/957

OM 314 A up to engine 492711

MB 314: 970

48-64 kW Diesel cyl. 97 dia.

MB Trac 700, 800, 900 / 440

OM 364: 908, 909

OM 364: 951

50-66kW Diesel cyl. 97,5 dia.

MB Trac

1000 /441

1100 /442, 443

OM 352 up to engine 760548

M.B. 353: 936/949/985

70-81kW Diesel cyl. 97 dia.

MB Trac

1000 /441,162

1100 /441,163

1300 /443,163

1400 /443,164

1600 /443,166

OM 366

M.B. 366: 908/912

OM 366 A

M.B. 366: 954/958/977

74-115kW Diesel cyl. 97,5 dia.

Unimog

U900, U1000, U1150, U1200, U1250,

U1350, U1400, U1450, U1550, U1600,

U1650, U1700, U1750, U2100, U2150

Front and rear axle parts, steering



Oil seal rear axle

dph-no.	OEM-no.	application	
47247	006 997 93 46		Size: 100 x 125 x 13/10 C 
47301 35022	008 997 62 46 000 997 74 46		Size: 110 x 140 x 13 NBR C 
47690 47694	010 997 78 47 010 997 84 47		Size: 115 x 140 x 13 NBR A/BS blue 
47691	010 997 79 47		Size: 115 x 140 x 13 NBR green 
47743	303 997 06 47		Size: 115 x 140 x 13 A NBR 
46846 47299	004 997 77 45 008 997 60 46		Size: 115 x 150 x 13 NBR C Rear axle 





Oil seal rear axle

dph-no.	OEM-no.	application	
46887	000 997 54 46		Size: 115 x 150 x 15 NBR CS blue
95130	015 997 93 47		Size: 120 x 145 x 15/12 FPM A/BS F WD
47693 47038 47010	010 997 81 47 006 997 05 46 005 997 03 46		Size: 120 x 145 x 15/12 C blue
94407	015 997 56 47		Size : 125 x 150 x 15/13 NBR A/BS WD
46879 33377	000 997 40 46 002 997 40 46		Size: 125 x 152,4 x 15 NBR CS
47022 47593 47300	005 997 44 46 006 997 21 47 008 997 61 46		Size: 125 x 150 x 15 C blue
47251	007 997 04 46		Size: 135 x 165 x 14/10 BS blue
47311	009 997 03 46		Size: 135 x 165 x 13/15 BS

Oil seal rear axle

dph-no.	OEM-no.	application	
47493	002 997 32 47		Size: 140 x 160 x 13 BS blue
82049	020 997 05 47		Size: 145 x 175/205 x 18/20 FPM ABS pole wheel outside
80835 36646	013 997 59 47 013 997 94 47		Size: 145 x 175 x 13 AW/B FPM
47389	011 997 31 46		Size: 145 x 175 x 13 FPM C
36407 47377 47710	011 997 12 46 011 997 01 46 011 997 52 47		Size: 145 x175 x13 A/B W NBR blue Rear axle, inner Size: 145 x175 x13 NBR C green (dph 6729)
82394	015 997 49 47		Size: 145 x 175/205 x 9/14 special

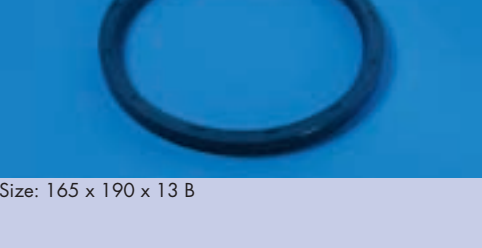
Oil seal rear axle

dph-no.	OEM-no.	application	
51230 47376	016 997 56 47 011 997 00 46		Rear axle, outside Size: 145 x175 x14 A /BS W blue NBR
4440 47527	011 997 44 46 003 997 66 47		Size: 145 x175 x14 NBR BS green (dph 4376)
47382 47386	011 997 16 46 011 997 23 46		Size: 148 x 170 x 15 NBR C
47759	335 997 00 47		Size: 150 x 180 x 13 NBR A blue
47758	317 997 00 47		Size: 150 x 180 x 14 NBR AS
4500 47753	304 997 04 47 304 997 11 47		Size: 165 x 190 x 13 A blue
46966	003 997 48 46	Size: 165 x 190 x 13 B	
4615	005 997 84 47		Size: 170 x 190 x 8,5 AS K
47309 47348 6477	009 997 00 46 010 997 00 46 304 997 17 47		Size: 185 x 210 x 13 NBR A blue

● Gasket for front axle

dph-no.	OEM-no.	application	
4276	317 333 11 64		Engine mount
			

● Oil seal for front axle

dph-no.	OEM-no.	application	
35021 46965	000 997 64 47 003 997 45 46		Size: 105 x 130 x 13 NBR C
			
47260 47716	007 997 36 46 011 997 71 47		Size: 100 x 120 x 13/10 front axle
			
109784	022 997 34 47	Front axle ATEGO Size: 100 x 120 x 11/16,5 BS special blue	
47728 47717	012 997 91 47 011 997 72 47		Size: 100 x 125x x 13 NBR A/BS
			
46949	002 997 64 46		Size: 110,3 x 133,3 x 12/10 C blue
			
46896	001 997 06 46		Size: 110 x 115x x 15 NBR C
			

Oil seal for front axle

dph-no.	OEM-no.	application	
47397	011 997 54 46		Size: 115 x 140 x 13 NBR C 
47040	006 997 13 46		Size: 118 x 140 x 13 NBR B 
47488 47489 47490 47541 47542	002 997 18 47 002 997 19 47 002 997 20 47 004 997 17 47 004 997 18 47		Size: 120 x 150 x 15/12 NBR CS 
109592	021 997 69 47	Size : 124 x 150 x 14,3 + 120 x 150 x 14,3 special Front axle Actros	
109470	018 997 33 47		Size: 137 x 165 x 13,5 FPM/NBR Cassette special 
47549 47574 47595 47459	004 997 59 47 005 997 45 47 006 997 31 47 001 997 05 47		Size: 140 x 165 x 12/15 FPM 
47356	010 997 30 46		Size: 160 x 180 x 10 NBR B 

● Oil seal for front axle

dph-no.	OEM-no.	application	
47357 47384 47723 47384	010 997 31 46 011 997 18 46 012 997 19 47 011 997 18 46		Size: 160 x 180 x 10/11 BS blue
47383	011 997 17 46		Size: 160 x 180 x 10 A/BS blue
47724	012 997 20 47		Size: 160 x 180 x 10 NBR B blue

● Oil seal trailer

dph-no.	OEM-no.	application	
109601	024 997 48 47	Size: 120 x 150 x 14,3/20 FPM SP	

● Oil seal front & rear axle

dph-no.	OEM-no.	application	
46760 47388 47391	009 997 67 47 011 997 26 46 011 997 36 46		Size: 100 x 130 x 13 NBR AS blue

● Gasket for rear axle

dph-no.	OEM-no.	application	
94626	346 356 01 27		Rear axle
35677	360 586 18 46		Washer / o-ring kit Repair kit Servo pump





Gasket set for steering

dph-no.	OEM-no.	application	
4044	366 586 54 46		Gasket set dph 
51740 36885	387 460 26 01 387 586 03 46		Repair kit power steering 
98015	1295 298 915		Repair kit manual transmission 
61250	1295 298 917		Oil seal kit manual transmission 





Repair kit for ABS rear axle

dph-no.	OEM-no.	application	
94500	659 350 00 35 659 350 01 35		 <p>Combi gasket kit for outside planetary gear with ABS</p> <p>Contents:</p> <ul style="list-style-type: none"> 1 pc lock plate dia 121 DB 355 356 01 73 1 pc lock plate dia 106 DB 346 356 00 73 1 pc oil seal outside ABS pole wheel DB 020 997 05 47 size: 145x175/205x18/20 FPM 1 pc oil seal inner DB 013 997 94 47 size: 145x175x13 FPM 1 pc O-ring green DB 016 997 40 48 size: 255x5 1 pc paper gasket steel plug 650 356 00 80 (DB 624 356 00 80) 1 pc paper gasket cast iron plug DB 650 356 01 80 (346 334 00 80) 1 pc washer 007603 024106 size: 24x29x2 CU 1 pc washer 007603 045100 size: 45x52x2 ALU

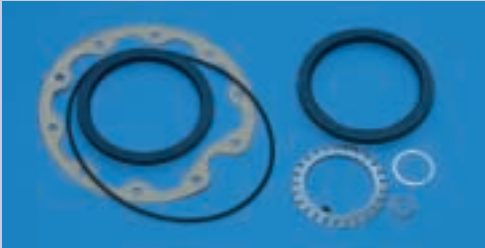

Repair kit for ABS rear axle

dph-no.	OEM-no.	application	
81438	659 350 01 35S	 <p>Combi gasket kit for ABS rear axle</p> <p>Contents:</p> <ul style="list-style-type: none"> 1 pc lock plate dia 121 DB 355 356 01 73 1 pc lock plate dia 106 DB 346 356 00 73 	<ul style="list-style-type: none"> 1 pc oil seal outside ABS pole wheel DB 015 997 49 47 size: 145x175/205x9/14 1 pc oil seal inner DB 013 997 94 47 size: 145x175x13 FPM 1 pc O-ring green DB 016 997 40 48 size: 255x5 1 pc paper gasket steel plug 650 356 00 80 (DB 624 356 00 80) 1 pc paper gasket cast iron plug DB 650 356 01 80 (346 334 00 80) 1 pc washer 007603 024106 size: 24x29x2 CU 1 pc washer 007603 045100 size: 45x52x2 ALU
35850	624 356 00 80S	 <p>Gasket set for outside planetary gear with steel plug</p> <p>Contents:</p> <ul style="list-style-type: none"> 1 pc lock plate dia 121 DB 355 356 01 73 1 pc oil seal outside DB 011 997 0046 size: 145x175x14 NBR 	<ul style="list-style-type: none"> 1 pc oil seal inner DB 011 997 01 46 size: 145x175x13 NBR 1 pc O-ring black DB 002 997 42 48 size: 255x5 1 pc paper gasket steel plug 650 356 00 80 (DB 624 356 00 80) 1 pc washer 007603 024106 size: 24x29x2 CU 1 pc washer 007603 045100 size: 45x52x2 ALU
94501	624 350 00 35	 <p>Combi gasket kit</p> <p>Contents:</p> <ul style="list-style-type: none"> 1 pc lock plate dia 121 DB 355 356 01 73 1 pc lock plate dia 106 DB 346 356 00 73 1 pc oil seal outside DB 016 997 56 47 size: 145x175x14 NBR 	<ul style="list-style-type: none"> 1 pc oil seal inner DB 011 997 12 46 size: 145x175x13 NBR 1 pc O-ring green 016 997 40 48 size: 255x5 FPM 1 pc paper gasket steel plug 650 356 00 80 (DB 624 356 00 80) 1 pc paper gasket cast iron plug DB 650 356 01 80 (346 334 00 80) 1 pc washer 007603 024106 size: 24x29x2 CU 1 pc washer 007603 045100 size: 45x52x2 ALU
80056	624 356 00 80KS	 <p>Combi gasket kit</p> <p>Contents:</p> <ul style="list-style-type: none"> 1 pc lock plate dia 121 DB 355 356 01 73 1 pc lock plate dia 106 DB 346 356 00 73 	<ul style="list-style-type: none"> 1 pc oil seal outside DB 011 997 00 46 size: 145x175x14 NBR 1 pc oil seal inner DB 011 997 01 46 size: 145x175x13 NBR 1 pc O-ring black DB 002 997 42 48 size: 255x5 NBR 1 pc paper gasket steel plug 650 356 00 80 (DB 624 356 00 80) 1 pc paper gasket cast iron plug DB 650 356 01 80 (346 334 00 80) 1 pc washer 007603 024106 size: 24x29x2 CU 1 pc washer 007603 045100 size: 45x52x2 ALU

Repair kit for ABS rear axle

dph-no.	OEM-no.	application	
109852	624 356 00 80SA		<p>size: 145 x 175 x 14 NBR 1 pc oil seal inner DB 011 997 01 46 size: 145 x 175 x 13 NBR 1 pc O-ring black DB 002 997 42 48 size: 255 x 5 NBR 1 pc paper gasket steel plug DB 650 356 00 80 1 pc washer 007603 024106 size: 24 x 29 x 2 CU 1 pc washer 07603 045100 size: 45 x 52 x 2 ALU</p>
		Repair kit rear axle, outside planetary gear	
		Contents:	
		1 pc lock plate dia 106 DB 346 356 00 73	
		1 pc oil seal outside DB 011 997 00 46	
81548	346 334 00 80S		<p>1 pc oil seal inner DB 011 997 01 46 size: 145 x 175 x 13 NBR 1 pc O-ring black DB 002 997 42 48 size: 255 x 5 1 pc paper gasket steel plug DB 346 334 00 80 1 pc washer 007603 024106 size: 24 x 29 x 2 CU 1 pc washer 007603 045100 size: 45 x 52 x 2 ALU</p>
		Gasket set for outside planetary gear with cast iron plug	
		Contents:	
		1 pc lock plate dia 121 DB 355 356 01 73	
		1 pc oil seal outside DB 011 997 00 46 size: 145x175x14 NBR	
81527	APL short set NBR		<p>Contents:</p> <p>1 pc oil seal outside DB 011 997 00 46 size: 145 x 175 x 14 NBR 1 pc oil seal inner DB 011 997 01 46 size: 145 x 175 x 13 NBR 1 pc O-ring black DB 002 997 42 48 size: 255 x 5</p>
81528	APL short set FPM	Contents:	
		1 pc oil seal outside DB 011 997 4446 size: 145 x 175 x 14 NBR BS green	
		1 pc oil seal inner DB 011 997 4346 size: 145 x 175 x 13 NBR C green	
		1 pc O-ring green DB 016 997 4048 size: 255 x 5	
93469	383 350 00 68		<p>Seal kit for rear wheel hub</p> <p>Contents:</p> <p>1 pc oil seal DB 004 997 7745 size: 115 x 150 x 13 NBR C 1 pc DB 327 356 01 80 1 pc DB 322 356 01 79 1 pc DB 322 356 01 73</p>
93470	385 350 00 68		<p>Seal kit for rear wheel hub</p> <p>Contents:</p> <p>1 pc oil seal DB 015 997 5647 size: 125 x 150 x 15/13 NBR A/BS WD 1 pc DB 317 356 00 80 1 pc DB 070952 085102</p>







● Repair kit for ABS rear axle







dph-no.	OEM-no.	application
48174	385 350 02 68	 <p>Seal kit for rear wheel hub</p> <p>Contents: 1 pc oil seal DB 010 997 81 47 (DB 006 997 05 46) size: 120 x 145 x 15/12 NBR C blue 1 pc DB 327 356 01 80 1 pc DB 070952 075103</p>
109823	942 350 39 35	 <p>Seal kit for Hypoid rear axle</p> <p>Contents: 1 pc oil seal DB 020 997 39 47 size: 145 x 175 x 17 1 pc lock washer 942 350 39 35 1 pc ABS seal ring DB 942 356 03 14 size: 150 x 196 x 15 1 pc cover plate DB 346 356 00 27 1 pc thrust ring DB 946 356 00 15</p>
109682	940 350 08 35	 <p>Seal kit for rear axle with ABS, 11,5 tons</p> <p>Contents: 1 pc oil seal DB 013 997 94 47 size: 145 x 175 x 13 FPM 1 pc oil seal DB 016 997 56 47 size: 14 5x 175 x 14 NBR</p>
109683	940 350 06 35	 <p>Seal kit for rear axle with ABS, 13 and 16 tons</p> <p>Contents: 1 pc oil seal DB 013 997 9447 size: 145 x 175 x 13 FPM</p>
		<p>1 pc seal ring DB 942 356 03 15 size: 150 x 196 x 15 1 pc cover plate DB 346 356 00 27 1 pc paper gasket steel plug DB 650 356 00 80 1 pc seal ring 255 x 5 FPM 75 green 1 pc lock plate dia 106 mm DB 346 356 00 73 1 pc washer DB 007603 045100 size: 45 x 52 x 2 ALU 1 pc washer DB 007603 024106 size: 24x29x2 CU 1 pc thrust ring wheel hub DB 355 356 12 15</p>
		<p>1 pc oil seal DB 016 997 56 47 size: 145 x 175 x 14 NBR 1 pc seal ring DB 942 356 03 15 size: 150 x 196 x 15 1 pc cover plate DB 346 356 00 27 1 pc paper gasket steel plug DB 650 356 00 80 1 pc seal ring 255 x 5 FPM 75 green 1 pc lock plate dia 106 mm DB 346 356 00 73 1 pc washer DB 007603 045100 size: 45 x 52 x 2 ALU 1 pc washer DB 007603 024106 size: 24 x 29 x 2 CU 1 pc thrust ring wheel hub DB 346 356 14 15</p>

● Repair kit for ABS front axle

dph-no.	OEM-no.	application
81517	355 356 01 73 S	 <p>Repair kit / Outside Planetary Gear</p> <p>Contents: 1 pc lock plate dia 121 DB 355 356 01 73 1 pc oil seal outside DB 015 997 57 47 size: 160 x 180 x 10/11 NBR</p>
		<p>1 pc oil seal inner DB 011 997 17 46 size: 160 x 180 x 10 NBR 1 pc o-ring black DB 494 334 00 59 size: 270 x 6 NBR 1 pc paper gasket cast iron plug DB 346 334 00 80 1 pc paper gasket steel plug DB 624 356 00 80 1 pc washer 007603 024106 size: 24 x 29 x 2 CU 1 pc washer 007603 045100 size: 45 x 52 x 2 ALU</p>

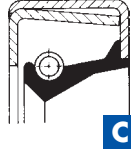
Overview of most popular oil seal types acc to DIN 3760/3761

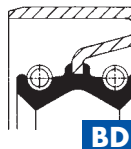
Application	Description
 A	rubber version with single lip
 AS	rubber version with sealing and dust lip
 AD	rubber version with 2 lips and 2 springs
 AW	rubber version with sealing lip and corrugated profile
 ASW	rubber version with sealing lip and dust lip and corrugated profile
 A/B	seal with combined elastomer/ metal outer cover

Application	Description
 B	metal cased open
 BS	metal cased open with dust lip
 C	metal cased closed
 CS	metal cased closed with dust lip
 BD	metal cased open with 2 lips
 A/BS	seal with combined elastomer/ metal outer cover with dust lip

Abbreviations at „style“

FL Washer
PR Profile seal
OR O-Ring
WR Oil seal

Complimentary definitions

RD Right hand helix
LD Left hand helix
WD Double helix
SF Special design
OF Without spring
V Reinforced seal lip
LA With sealant film
W Corrugated profile
SP Special

Abbreviations at „mat“ (material)

ACM Polyacryl rubber
FPM Fluor rubber (Viton)
MVQ Silicone rubber
NBR Nitril rubber
EPDM Ethylen-Propylen-Dien-rubber
PTFE Polyterafluorethylen
HNBR Hydrogenated NBR
AL Aluminium
CU Copper
FE Iron
FZ Felt

Standard terms and conditions

Standard Terms and Conditions of Trade and Delivery, as established by Dichtungspartner Hamburg GmbH, Ferdinand-Harten-Str. 15, 22949 Ammersbek, Germany, hereafter referred to as "dph":

Application

The terms and conditions set out below form part of all contracts for services, supplies and quotations by dph. Sales shall be made solely on the basis of the terms and conditions below. Ancillary agreements and amendments shall only be deemed valid if in writing.

If our contracting partner has its own terms and conditions which differ from dph's terms and conditions, we shall only be bound by the aforementioned terms and conditions of the contracting partner if we specifically accepted them in writing on conclusion of the contract. We hereby specifically state that we shall not accept a counter-confirmation by the customer with reference to its own terms and conditions.

Quotations

All quotations are subject to change. We shall not be bound by any arrangements made orally, by telegraph or telephone until we have issued a written confirmation. Any details given in brochures, advertisements, etc., including prices, shall not be binding until specifically agreed in writing.

Prices

Our prices are given in euros (EUR) ex works and exclude German VAT. Prices exclude postage/delivery, packing and insurance.

Delivery

1. Prices are given ex works. Unless free delivery has been agreed, the purchaser shall bear the costs associated with dispatch/shipment. It shall also bear costs ex delivery destination. Freight refunds are not granted. The goods shall be insured only if the customer so requests in writing, and insurance shall be at the customer's expense.
2. Collection and dispatch of the goods ex works or distribution warehouse is in all cases at the customer's risk.
3. We reserve the right to charge a minimum-quantity flat rate or a minimum cost-contribution flat rate for small orders.
4. In the case of blanket/call orders, we are entitled to procure the material for the whole order and to manufacture the entire quantity ordered immediately. Any change requests by the customer cannot be accepted after the order has been placed, unless this was specifically agreed.

Payment

1. Our invoices are payable in euro (EUR).
2. Invoiced amounts are payable (free of dispatch costs and other expenses) within 14 days after invoice date less 2% discount, or within 30 days after invoice date without deduction. Default interest is payable at the rate of 8% above the base interest if payment is late.
3. Cheques shall be regarded as cash payments, provided they have been sent to us in sufficient time that they can be cashed within the above payment periods.
4. Only payments made at the place of performance have the effect of discharging obligations. Payments made to employees of our company shall only discharge obligations if such employees have the appropriate collecting power (Inkassovollmacht).
5. If it becomes apparent after conclusion of the contract that our claim to payment may be in jeopardy because the customer is not able to discharge its obligations, then any other debt claims we have shall become due and payable immediately. In this event, we are entitled to make any remaining deliveries subject to payment in cash or the provision of security. This will not affect any further legal claims.
6. The customer may only set off payments against counterclaims which we have accepted or which have the authority of a final court judgment. This also applies to the retention of payments.

Tools and equipment

Tools and equipment which we manufacture or engage a third party to manufacture shall be our property, even if our customer pays part of the manufacturing costs.

Packaging

Paper packaging shall be subject to the lowest-possible charge. Chests, crates, barrels, sacks and other types of packaging shall be invoiced and, if returned freight-paid and in good condition within 4 weeks after receipt of the delivery, a credit note will be issued for 2/3 of the amount charged. In the event that a rail company classifies a delivery as inadequately packed, this may not be used against us.

Periods of delivery

1. The periods of delivery shall begin when all details of the order have been explained, however, not before the purchaser has fulfilled any contractual obligations which must be performed beforehand. The delivery date is deemed to have been met if the goods have left the warehouse by the end of such date or, if the delivery is delayed for reasons not attributable to us, on notification that the goods are ready for dispatch within the agreed period of delivery.
2. The delivery obligation is subject to the condition that dph has been supplied correctly and in due time by its suppliers.
3. Partial deliveries within the agreed time and quantities are permissible and may be invoiced separately.
4. If any acts of force majeure, industrial disputes or their consequences or other events which are outside the scope of our control delay the performance of our delivery obligation, regardless of whether they affect us or our sub-contractors, the period of delivery shall be extended by the length of such delay. Both parties shall have the right to cancel the contract if the delivery later becomes impossible or unreasonable for one of the parties due to an event of the above nature.
5. The purchaser is entitled to terminate the contract, in accordance with the legal provisions, in the event of delay or if delivery is impossible for reasons attributable to us. If the delivery is delayed and if the purchaser thereby suffers loss, it is entitled to demand a lump-sum amount as compensation for the delay. Such compensation shall be, for each full week of delay, 0.5% of the value of that portion of the total delivery which, as a result of the delay, cannot be used on time or in accordance with the contract, up to a maximum of 5% of such value.
6. If delivery is delayed at the purchaser's request, the purchaser shall be charged the costs of storage, commencing 2 weeks after notification that delivery is ready, subject to a minimum charge of 1% of the invoice amount for each week.

Tolerances

Any recommendations we give as to the use of our products are made to the best of our knowledge. The purchaser is at all times under an obligation to satisfy itself by means of its own enquiries that the goods delivered are suitable for the intended purpose. Deviations from samples and earlier deliveries are permissible if they do not affect quality and use. We reserve the right to deviations in quantity of $\pm 10\%$.

Complaints and liability for defects

1. Immediately after receipt, the purchaser must inspect the goods and give written notification promptly, or no later than within 10 days after receipt, of any obvious visible defects, incorrect quantities or incorrect deliveries, specifying the defect. In the case of latent defects, it must do this within 10 days after discovery of the defect.
2. If there are defects, we guarantee as follows: We shall, at our discretion, replace free of charge or repair all parts which prove to be unusable or whose use is not inconsiderably affected as a result of circumstances existing before risk was transferred.

3. The purchaser is entitled to rescission of the contract or to a reduction in price if we allow a reasonable extension of time for post-performance or repairs to elapse without resolving the defect, or if more than one attempt at post-performance or repair does not resolve the defect. If we deliver a defect-free item for the purpose of supplementary performance, or if the purchaser rescinds the contract, then it must pay value-related compensation for the benefit derived. The value of the benefit derived shall be determined by pro rata temporis straight-line depreciation in the ratio between the actual period of use and the estimated useful life.
4. The statutory limitation period of 2 years shall apply to notification of defects under Section 437 BGB (Bürgerliches Gesetzbuch – German Civil Code).
5. The provisions below under "General Liability" shall apply to liability to pay compensatory damages for liability for defects.

General liability

1. Without prejudice to the provisions under point 5 of "Periods for delivery", claims for damages of any kind in connection with and apart from liability for defects are excluded – for delay or impossibility, for breach of other contractual obligations, for mistakes on conclusion of the contract, for tort or for any other legal reason, in particular also for damages which do not occur to the items delivered themselves. There shall only be liability where there is intentional conduct, gross negligence, culpable injury to life, limb or health, defects which we have fraudulently concealed, on assumption of a warranty made regarding the existence of any specific feature or for defects in the items delivered, to the extent that there is liability under product liability laws for material damage to privately used items and for personal injury.
2. We shall also be liable for culpable breach of essential contractual obligations. However, provided there is no gross fault, such liability shall be limited to damage which is deemed typical as regards this type of contract and reasonably foreseeable.

Returns

Returns which are not based on a legal claim shall only be accepted, carriage paid, with our express written consent. As compensation for the costs incurred on any return, we shall retain from the credit note a corresponding reduction in the net invoiced value of the goods, subject to a minimum of 20% of the net invoiced value of the goods.

Reservation of title

1. The goods delivered shall remain our property until all outstanding amounts owed to us in connection with the business relationship, including incidental expenses, have been paid. If operating an open account, the property subject to the reservation of title shall be deemed to be security for our current account.
2. If our goods are combined or mixed with other goods which do not belong to us, we shall have joint ownership in the new object or the mixed item in proportion to the invoice value of the goods subject to the reservation of title compared with the value of the other combined or mixed goods at the time they were combined or mixed. If, as a result of combination, the purchaser acquires sole ownership in the new item, it hereby assigns to us joint ownership in the new item in proportion to the invoice value of our goods subject to the reservation of title compared with the value of the other combined goods remaining at the time they were combined, and shall keep such item in custody for us using the care of a prudent merchant.
3. Resale of the goods delivered, even if combined or mixed, is only permitted to resellers in the usual course of business and subject to the reservation of title and only if the debt claim arising from the resale is assigned to us. The purchaser may not pledge the goods as collateral nor transfer ownership therein by way of security, nor may it agree on a non-assignment clause. The purchaser must notify us immediately if there is any pledge or any other third-party action which may affect our rights.
4. The purchaser hereby assigns to us in advance any outstanding debts owed to it from the resale or for any other legal reason in respect of the goods we have supplied, both existing and arising in future as soon as they come into being. We accept such assignment. The value of the goods subject to the

reservation of title shall be our invoice amount plus a security premium of 10% which shall however not apply if third-party rights present an obstacle to this. If our goods are resold after they have been combined or mixed with other goods, or if the new item which arises through combination is resold, the claim against the purchaser's customer will be assigned in the amount of the invoice value of our processed, combined or mixed item, or up to the amount which corresponds to our share in the joint property, if this is lower.

5. The purchaser is entitled to collect the debt claims assigned provided that it duly fulfils its payment obligations to us.
6. If the value of the security assigned to us exceeds our debt claims by more than 10% in total, we are under an obligation to release the securities of our choice upon request by the purchaser. Ownership in the goods subject to the reservation of title and the assigned debt claims shall pass to the customer on payment of all our debt claims in connection with the business relationship.

Property rights

If we have made our supplies in accordance with drawings, models, samples or other documents provided by the purchaser, the purchaser guarantees that third-party property rights are not breached. If a third party claims in such a case that we are breaching a property right, e.g. through the manufacture or supply of the goods, then we shall be entitled, without further inspection, to discontinue our activity subject to our other rights. The purchaser undertakes to notify us immediately if there are any risks of breach or alleged cases of breach as soon as they become known.

Place of performance, jurisdiction, applicable law, general

1. The place of performance for deliveries and payments is Ammersbek. The courts of Ahrensburg will have jurisdiction for any disputes with traders or with people who do not have a legal domicile within Germany – even in the cases involving bills of exchange and cheques. We are also entitled, at our discretion, to bring an action against the purchaser before the courts which have jurisdiction in the place where the purchaser has its head office.
2. German law will apply to the contractual relationship. The provisions of UN sales of goods law will not apply.
3. The latest version of Incoterms 2000 will apply if clauses defined in the Incoterms are agreed.

Data storage

As required by Section 28 of the Bundesdatenschutzgesetz (Federal Data Protection Act - BDSG), we draw attention to the fact that the data necessary for the purposes of our business will be processed and stored using data processing equipment in accordance with Section 33 of the BDSG. The purchaser agrees that we may use the data obtained from our business relationship with it, in accordance with data privacy provisions, only for our own business purposes.

Severability and concluding provision

If any individual provisions of these Terms and Conditions should be void, this shall not affect the validity of the remaining provisions. Any provision which is void will be replaced by a valid provision which comes as close as possible to the purpose sought by the void provision. This is an English translation of the original Standard Terms and Conditions. In the event of any conflict or inconsistency between the English translation and the German original, the German original shall prevail. Neither the Company nor the Language Professional can accept liability for any direct, indirect, special, consequential or other losses or damages arising out of erroneous translations. Only the German version shall be deemed authoritative.

Date: June 2004

Repair Kits

Air Compressor Repair Kits

Wheel Brake Z-CAM

Brake Caliper Repair Kits

Clutch Master Cylinder Repair Kits

Clutch Servo Unit Repair Kits

Brake Master Cylinder Repair Kits

LSV Repair Kits

EBS & ABS Modulator Repair Kits

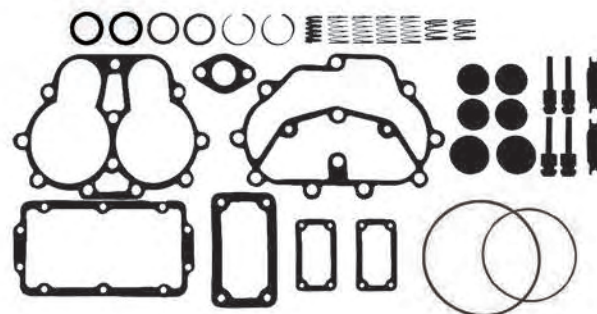
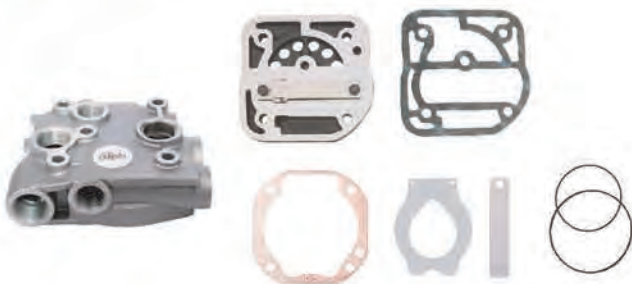

Dichtungspartner Hamburg



Contents

COMPRESSOR REPAIR KITS

DAF	003 - 024
IVECO	027 - 040
MAN	043 - 082
MERCEDES	085 - 132
RENAULT	135 - 146
SCANIA	149 - 156
VOLVO	159 - 184
Piston & Rings	187 - 190
Wheel Brake (Z-CAM)	191 - 194
Brake Caliper Repair Kit	195 - 221
Clutch Master Cylinder Repair Kit	222 - 229
Brake Master Cylinder Repair Kit	230
Clutch Servo Unit Repair Kit	231 - 239
Load Sensing Limiting Valve Repair Kit	240
EBS & ABS Modulator Repair Kit	241-243



DAF



DAF

95XF COMPRESSOR REPAIR KIT

TWIN CYLINDER AIR COMPRESSOR

dph-nr 1458166

DAF

1310523
1451651

WABCO

911 504 500 0
911 504 501 0
911 504 503 0

VEHICLE APPLICATION

95 XF
CF75
CF85
CKD
F75
F95
YTZ95



Complete Cylinderhead

dph-nr 1455102



Repair Kit

dph-nr 1258910

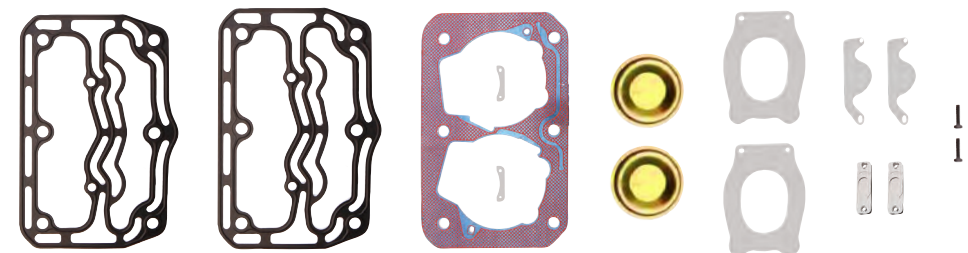

Gasket Kit

dph-nr 1455100

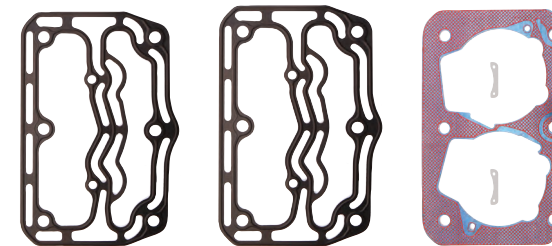

Valve Kit

dph-nr 1455101



All manufacturers names, numbers, symbols and descriptions are used for reference purposes only.



All manufacturers names, numbers, symbols and descriptions are used for reference purposes only.





DAF

85CF COMPRESSOR REPAIR KIT

TWIN CYLINDER AIR COMPRESSOR

dph-nr 1458167

DAF

- 1282723
- 1241874
- 1321470
- 1321708
- 1396290

KNORR-BREMSE

- LP4823
- LP4830
- II18599
- SEB01782
- II34841
- II15697
- II34840

VEHICLE APPLICATION

- 85CF
- 865AVM
- 1160AVM
- 825AVM
- CKD
- 75CF



Complete Cylinderhead

dph-nr 1424695

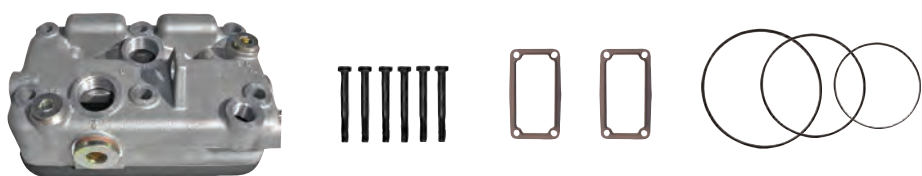

Valve Plate Kit

dph-nr 1455105

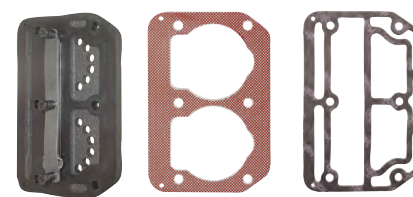

Valve Plate

dph-nr 1455106



Repair Kit

dph-nr 1455103

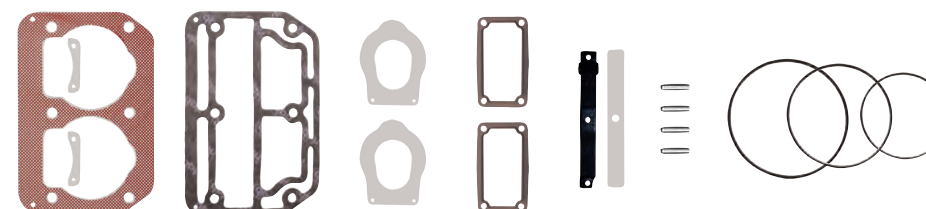

Repair Kit

dph-nr 1258845

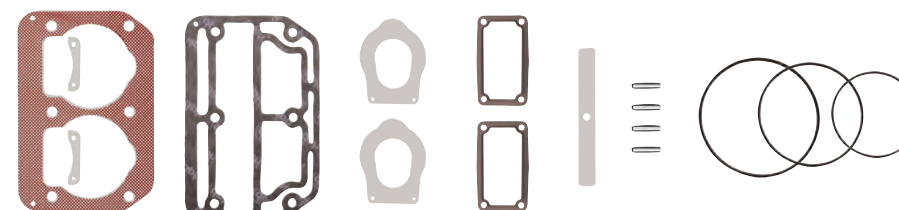

Gasket Kit

dph-nr 1258846

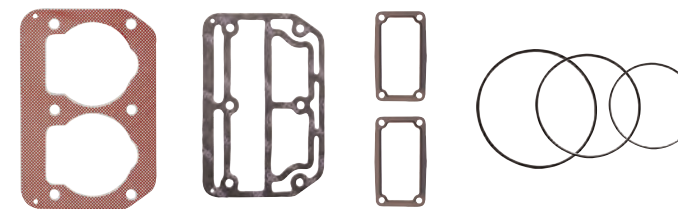

Valve Kit

dph-nr 1455104



All manufacturers names, numbers, symbols and descriptions are used for reference purposes only.



All manufacturers names, numbers, symbols and descriptions are used for reference purposes only.





DAF

LP4869 TWIN CYLINDER COMPRESSOR REPAIR KIT

TWIN CYLINDER AIR COMPRESSOR

dph-nr 1458168

DAF

- 1320400
- 1320401
- 1348480
- 1396282
- 1396283



KNORR-BREMSE

- LP4969
- LP4970
- LP4983

VEHICLE APPLICATION

- 825 AVM
- 865 AVM
- 85 CF
- DB250
- F2100

Valve Plate Kit

dph-nr 1455109

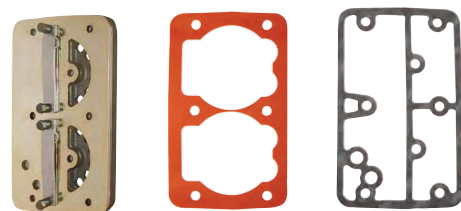

Repair Kit

dph-nr 1258867

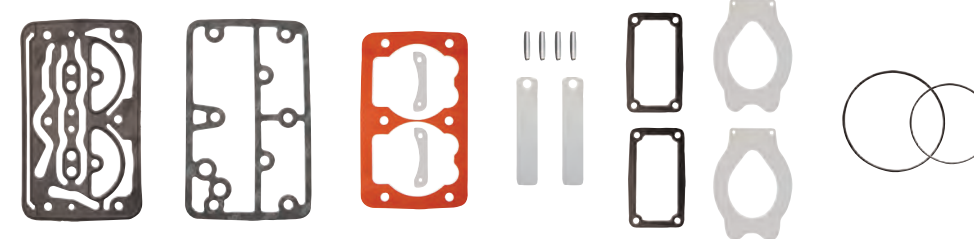

Gasket Kit

dph-nr 1258868

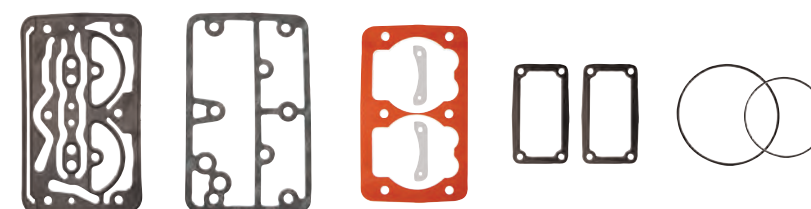

Valve Kit

dph-nr 1455108



Valve Plate

dph-nr 1455110



All manufacturers names, numbers, symbols and descriptions are used for reference purposes only.



All manufacturers names, numbers, symbols and descriptions are used for reference purposes only.





DAF

F95 380 COMPRESSOR REPAIR KIT

TWIN CYLINDER AIR COMPRESSOR

dph-nr 1458169

DAF

0537990
0528737
0762788

WABCO

911 504 050 0
911 504 051 0
911 504 052 0

VEHICLE APPLICATION

F95 380



Valve Plate Kit

dph-nr 1455112

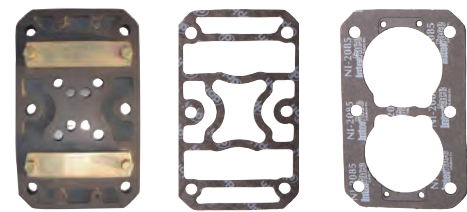

Full Repair Kit

dph-nr 1455111



Repair Kit

dph-nr 1258907



Gasket Kit

dph-nr 1258908

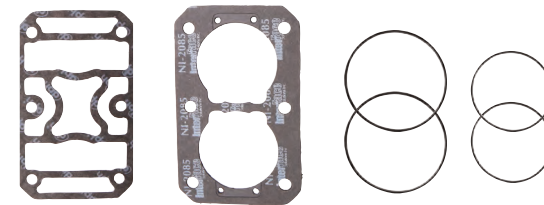

Valve Kit

dph-nr 1258909



Cooling Plate

dph-nr 1455113



All manufacturers names, numbers, symbols and descriptions are used for reference purposes only.



All manufacturers names, numbers, symbols and descriptions are used for reference purposes only.





DAF

F95 400 COMPRESSOR REPAIR KIT

TWIN CYLINDER AIR COMPRESSOR

dph-nr 1458170

DAF

- 1243571
- 1274407
- 1298052
- 1271789
- 1265249
- 1212618
- 1279029
- 1279031
- 1212617

WABCO

- 911 504 056 0
- 911 504 059 0
- 911 504 060 0

VEHICLE APPLICATION

F95 400



Complete Cylinderhead

dph-nr 1455118



Full Repair Kit

dph-nr 1455114



Repair Kit

dph-nr 1455115

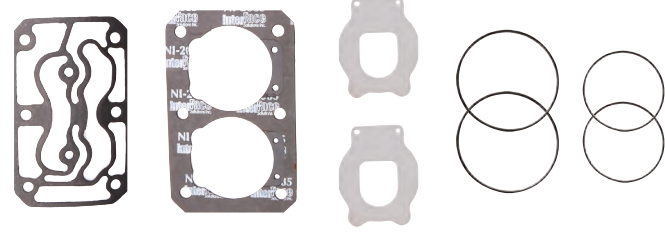

Gasket Kit

dph-nr 1455116

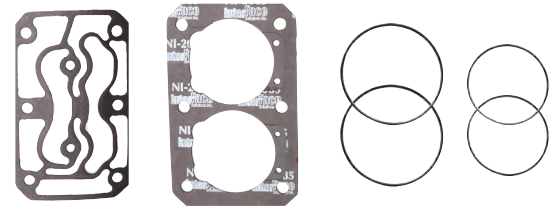

Valve Kit

dph-nr 1455117



All manufacturers names, numbers, symbols and descriptions are used for reference purposes only.



All manufacturers names, numbers, symbols and descriptions are used for reference purposes only.





DAF

TWIN CYLINDER 704cc COMPRESSOR REPAIR KIT

TWIN CYLINDER AIR COMPRESSOR dph-nr 1458171

DAF
 1506365
 1518141
 3255427
 1361098
WABCO
 911 505 153 0
 911 505 154 0
VEHICLE APPLICATION
 2800 ATI
 3300 ATI
 3600 ATI



Complete Cylinderhead dph-nr 1455121



Repair Kit dph-nr 1258911

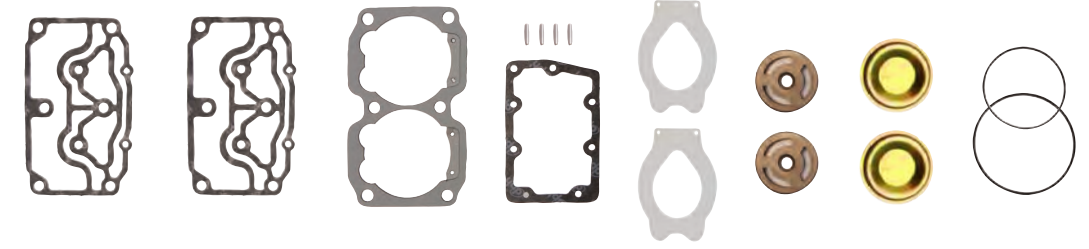

Repair Kit dph-nr 1455119

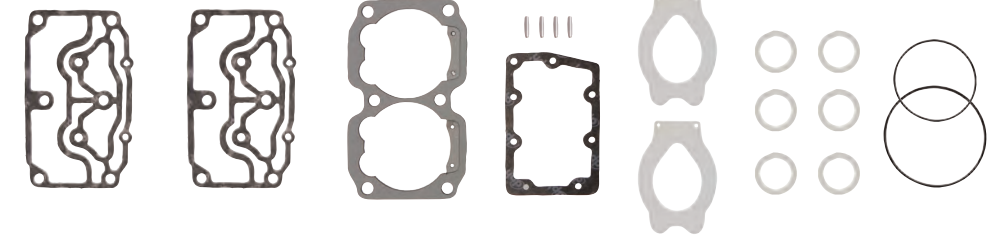

Gasket Kit dph-nr 1455120

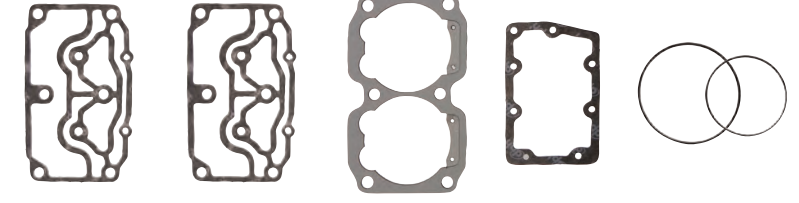

Valve Kit dph-nr 1258912

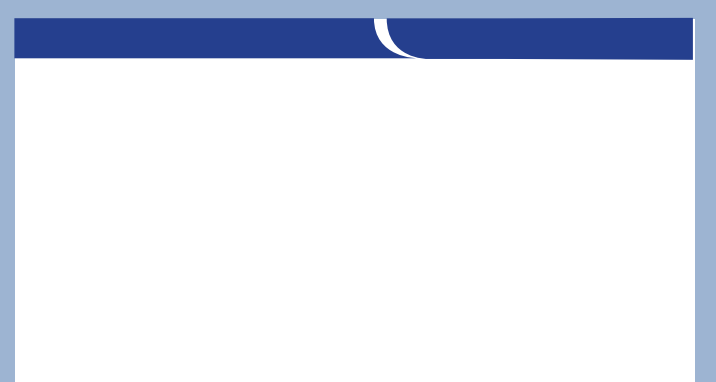
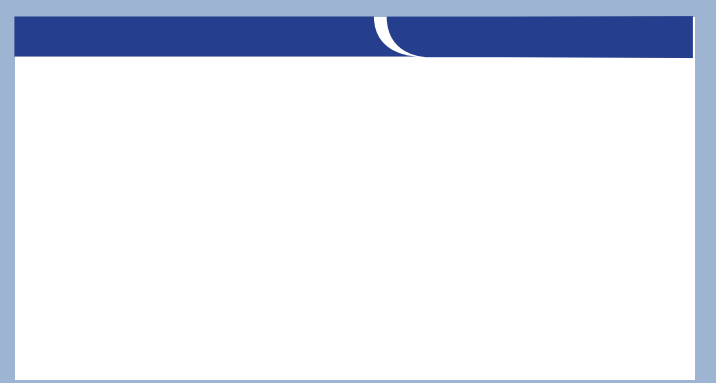
All manufacturers names, numbers, symbols and descriptions are used for reference purposes only.



All manufacturers names, numbers, symbols and descriptions are used for reference purposes only.





DAF

TWIN CYLINDER 704cc COMPRESSOR REPAIR KIT

TWIN CYLINDER AIR COMPRESSOR dph-nr 1458172

DAF

- 555097
- 555098
- 537745

WABCO

- 911 501 060 0
- 911 501 061 0
- 911 501 050 0
- 911 501 051 0

VEHICLE APPLICATION

- 2800 ATI
- 3300 ATI
- 3600 ATI

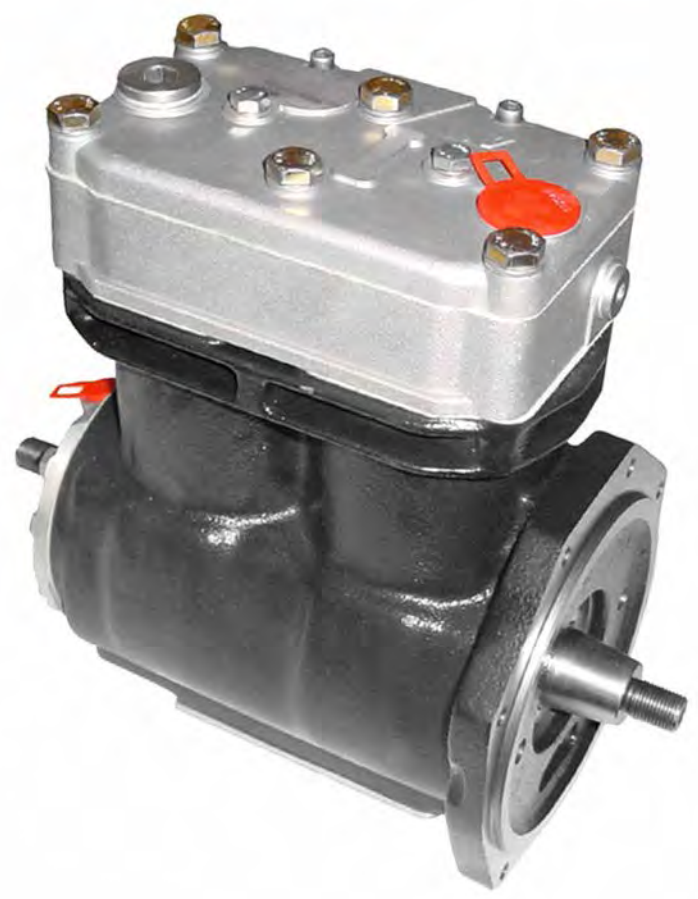

Full Repair Kit dph-nr 1258904

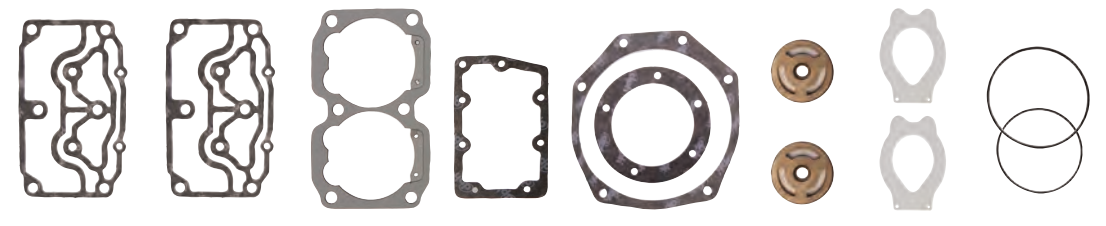

Repair Kit dph-nr 1455122

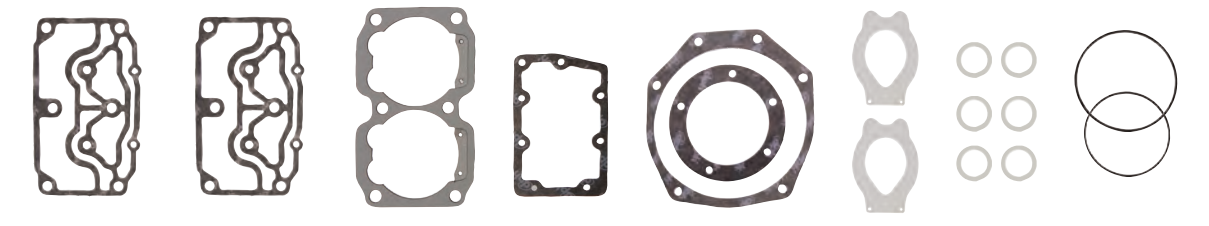

Gasket Kit dph-nr 1258905

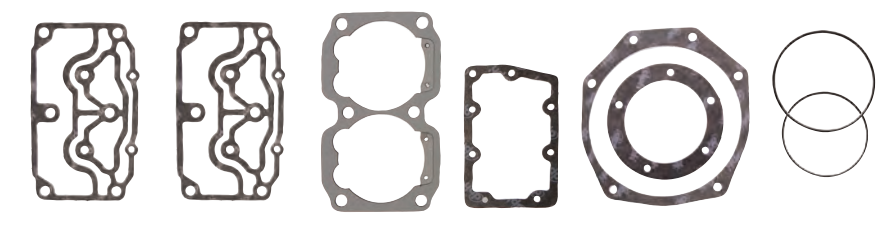

Valve Kit dph-nr 1258906

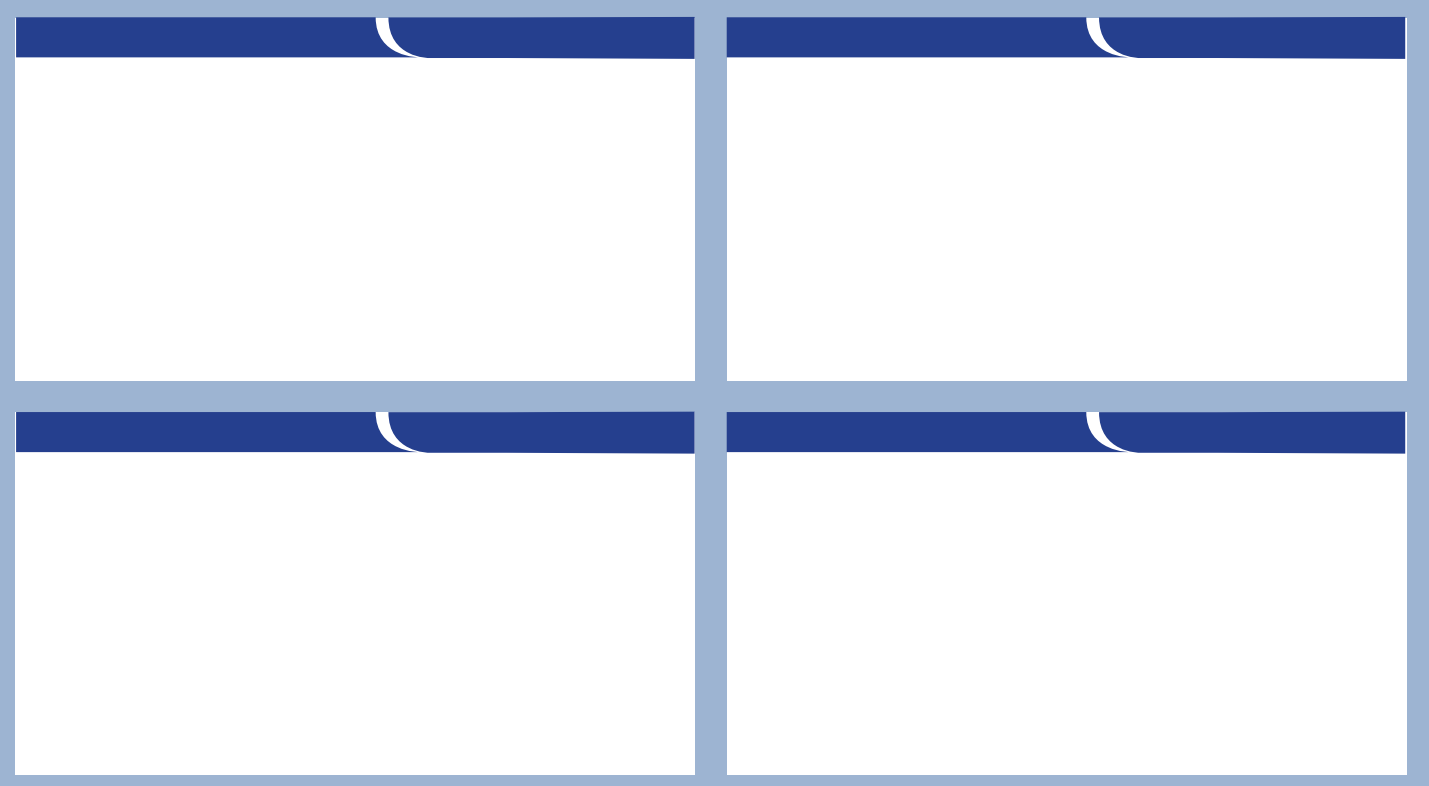

All manufacturers names, numbers, symbols and descriptions are used for reference purposes only.



All manufacturers names, numbers, symbols and descriptions are used for reference purposes only.





DAF

XF95 TWIN CYLINDER COMPRESSOR REPAIR KIT

TWIN CYLINDER AIR COMPRESSOR

dph-nr 1458173

DAF

- 1628444
- 1604420
- 1736785

WABCO

- 911 504 504 0
- 911 504 505 0
- 911 504 506 0

VEHICLE APPLICATION

- XF95
- 1260VS
- TBR2175
- 95XF
- 1160AVM
- F95
- CF85II
- CF85C
- F75
- 1260PP
- 85CF
- 75CF
- KD



Complete Cylinderhead

dph-nr 1455127

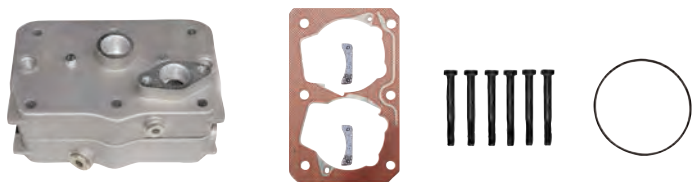

Repair Kit

dph-nr 1455123

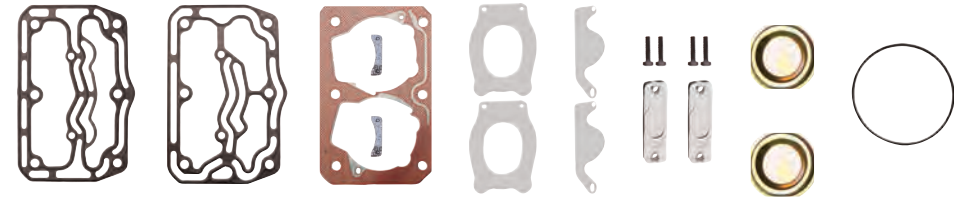

Gasket Kit

dph-nr 1455124

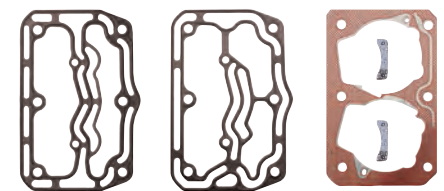

Valve Kit

dph-nr 1455125



Valve Plate

dph-nr 1455126



All manufacturers names, numbers, symbols and descriptions are used for reference purposes only.



All manufacturers names, numbers, symbols and descriptions are used for reference purposes only.





Dichtungspartner Hamburg

DAF

TWIN CYLINDER 75mm COMPRESSOR REPAIR KIT

TWIN CYLINDER AIR COMPRESSOR

dph-nr 1458174

DAF

1287663
0280408

WABCO

911 506 052 0

VEHICLE APPLICATION

KD
MB230
SB220
SB225
SB3000
SBG220



Full Repair Kit

dph-nr 1258856

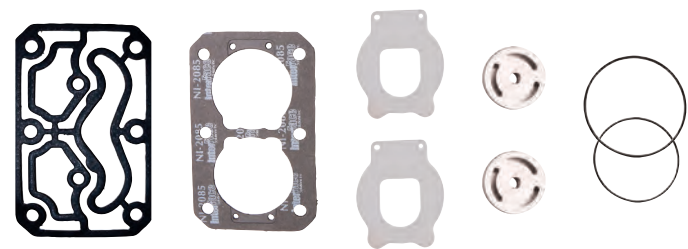

Repair Kit

dph-nr 1455128

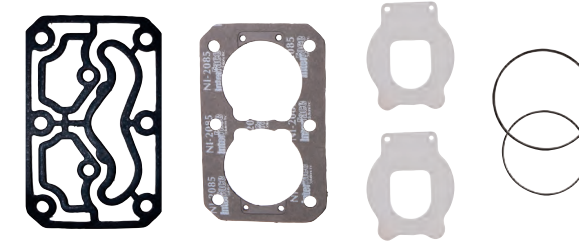

Gasket Kit

dph-nr 1455129

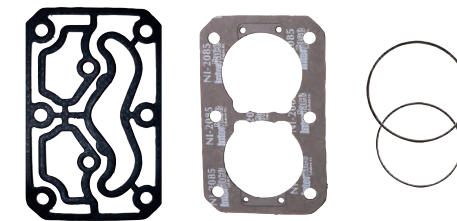

Valve Kit

dph-nr 1258857

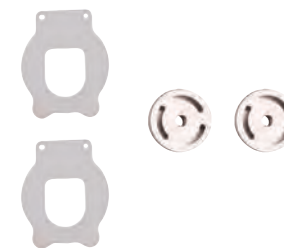

All manufacturers names, numbers, symbols and descriptions are used for reference purposes only.



All manufacturers names, numbers, symbols and descriptions are used for reference purposes only.





DAF

CF75 NEW MODEL TWIN CYLINDER COMPRESSOR REPAIR KIT

TWIN CYLINDER AIR COMPRESSOR

dph-nr 1458175

DAF

- 1795776
- 1736790
- 1689065
- 1696200
- 1805490
- 1736795
- 1795775
- 1813541
- 1813542

WABCO

- 912 518 100 0
- 912 518 102 0
- 912 518 103 0
- 912 518 200 0
- 912 518 201 0
- 912 518 202 0
- 912 518 204 0
- 912 518 205 0
- 912 518 206 0
- 912 518 207 0

VEHICLE APPLICATION

CF75



Complete Cylinderhead

dph-nr 1455134

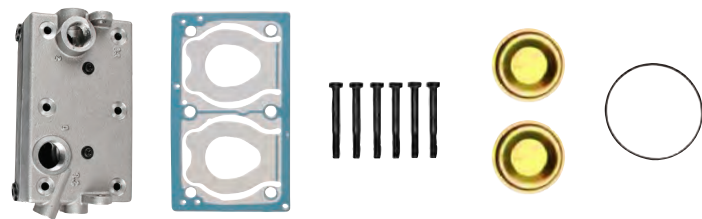

Valve Kit

dph-nr 1455133

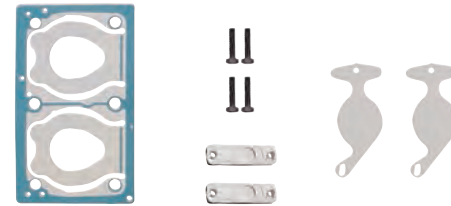

Valve Plate

dph-nr 1424697



Repair Kit

dph-nr 1455130

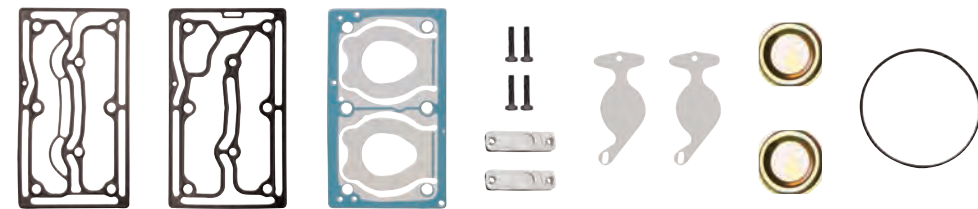

Head Repair Kit

dph-nr 1455131

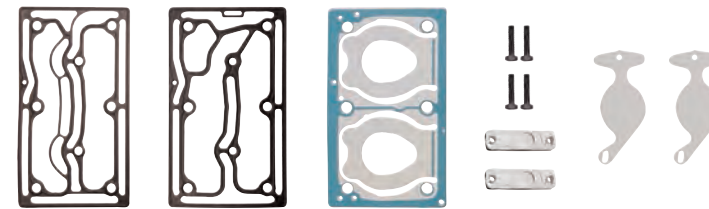

Gasket Kit

dph-nr 1455132

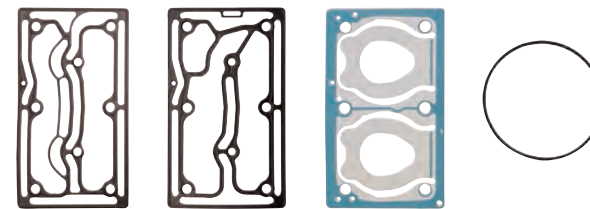



DAF

TWIN CYLINDER COMPRESSOR REPAIR KIT

TWIN CYLINDER AIR COMPRESSOR

dph-nr 1458176

DAF

1505917

WABCO

412 704 008 0



Complete Cylinderhead

dph-nr 1455139

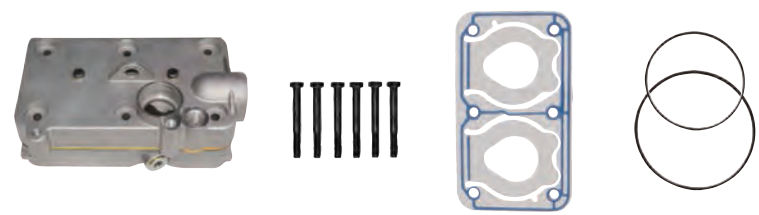

Repair Kit

dph-nr 1455135

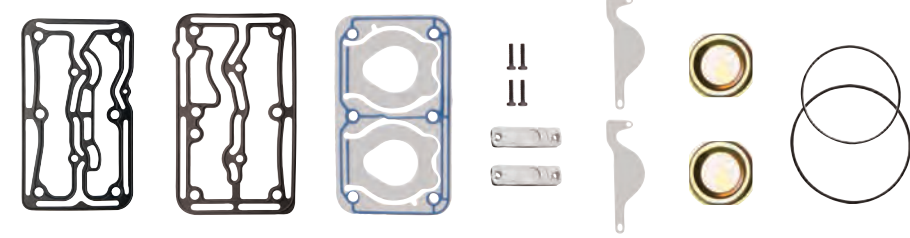

Head Repair Kit

dph-nr 1455136

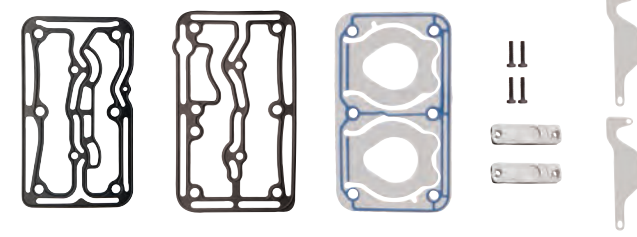

Gasket Kit

dph-nr 1455137

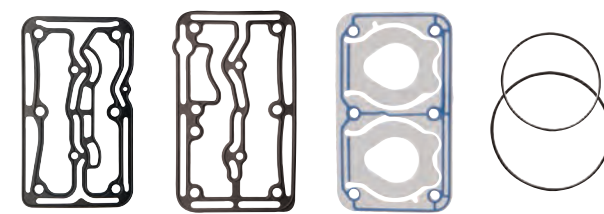

Valve Kit

dph-nr 1455138

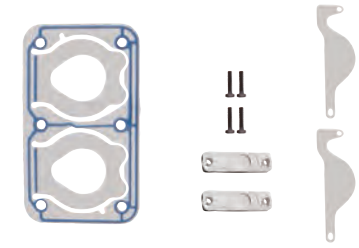

Valve Plate

dph-nr 1455140



All manufacturers names, numbers, symbols and descriptions are used for reference purposes only.



All manufacturers names, numbers, symbols and descriptions are used for reference purposes only.



IVECO



IVECO

IVECO





Dichtungspartner Hamburg

IVECO

TWIN CYLINDER 82mm COMPRESSOR REPAIR KIT

TWIN CYLINDER AIR COMPRESSOR

dph-nr 1458177

IVECO

- 98452939
- 98421120
- 99476238
- 4850697
- 500314094

KNORR-BREMSE

- ACX82A
- ACX83A
- ACX76
- ACX805

VEHICLE APPLICATION

- TURBOCITY
- EUROCARGO 370SE.27
- EUROFIRE
- EUROTECH
- EUROSTAR
- EUROTRAKKER



Complete Cylinderhead

dph-nr 1455143



Repair Kit

dph-nr 1455141

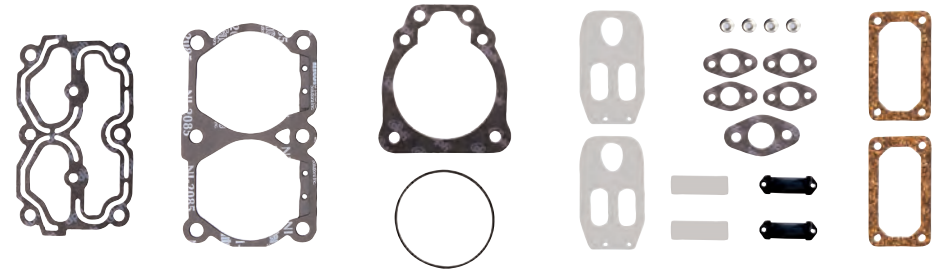

Repair Kit

dph-nr 1258843

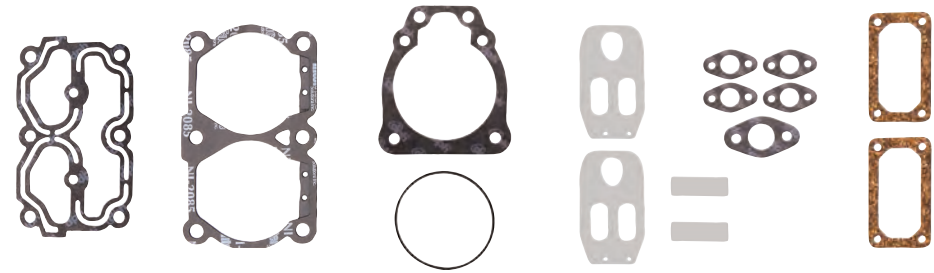

Gasket Kit

dph-nr 1455142

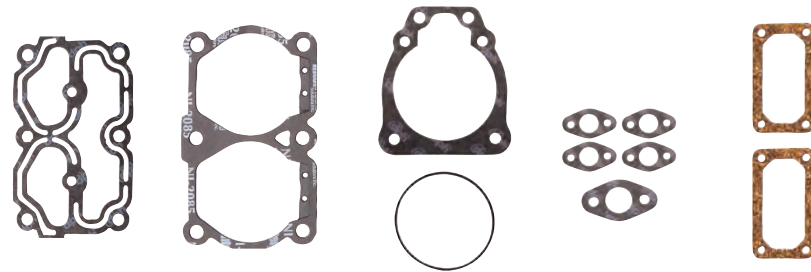

Valve Kit

dph-nr 1258844



All manufacturers names, numbers, symbols and descriptions are used for reference purposes only.



All manufacturers names, numbers, symbols and descriptions are used for reference purposes only.



IVECO

IVECO



Dichtungspartner Hamburg

IVECO

TWIN CYLINDER 80mm COMPRESSOR REPAIR KIT

SINGLE CYLINDER AIR COMPRESSOR

dph-nr 1458178

IVECO

41211219

WABCO

412 352 008 0

VEHICLE APPLICATION

STRALIS
TRAKKER
EUROTECH
EUROSTAR



Repair Kit

dph-nr 1455144

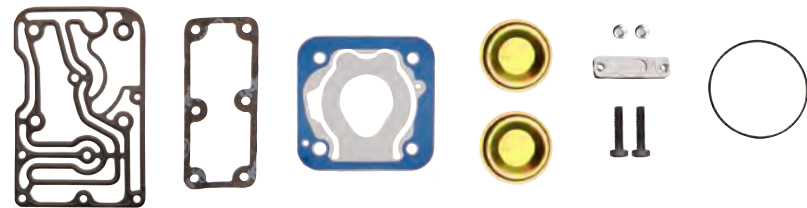

Gasket Kit

dph-nr 1455145

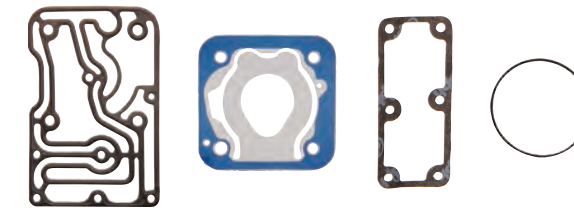

Valve Kit

dph-nr 1455146

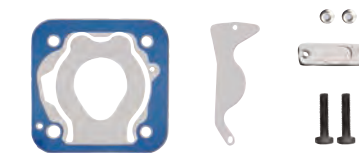

All manufacturers names, numbers, symbols and descriptions are used for reference purposes only.



All manufacturers names, numbers, symbols and descriptions are used for reference purposes only.



IVECO

IVECO

IVECO

4713813
98421114

KNORR-BREMSE

ACX75ZFG
ACX75ZF
ACX75ZGG
ACX79CG
ACX79EG

VEHICLE APPLICATION

TURBOSTAR



Complete Cylinderhead

dph-nr 1455149

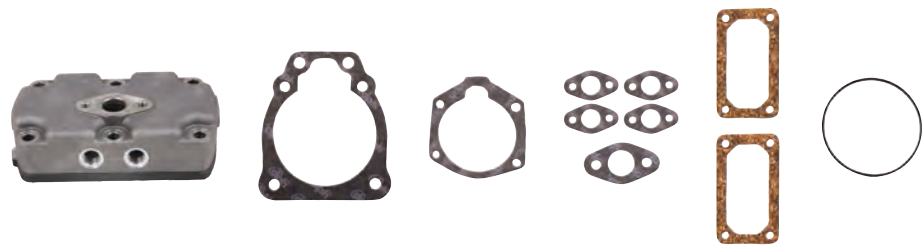

Repair Kit

dph-nr 1258914

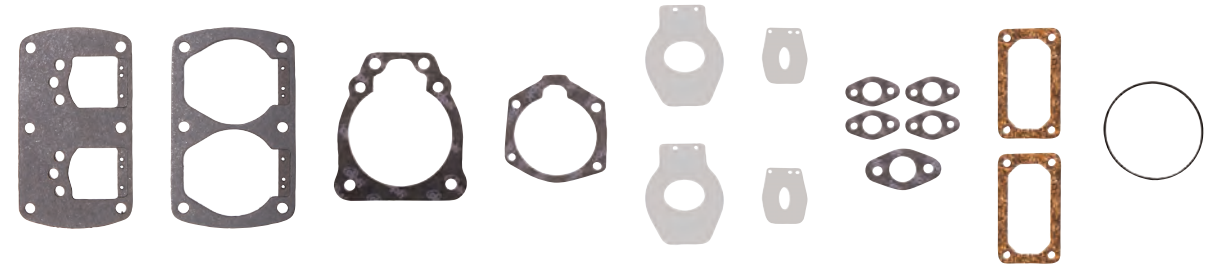

Gasket Kit

dph-nr 1455147

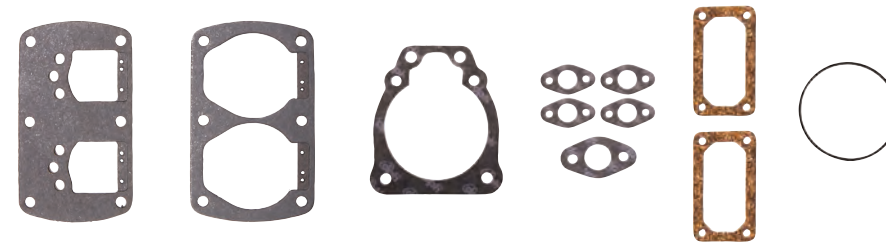

Repair Kit

dph-nr 1455148

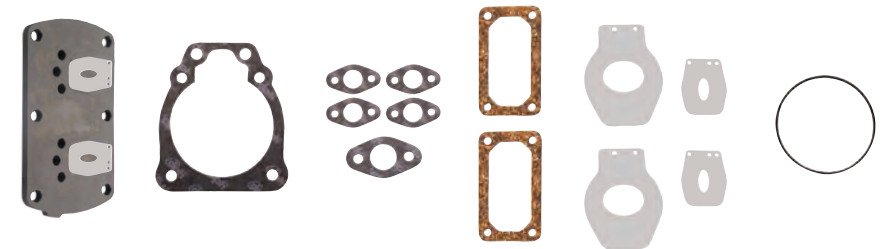

Valve Kit

dph-nr 1258915





Dichtungspartner Hamburg

IVECO

SINGLE CYLINDER 80mm COMPRESSOR REPAIR KIT

SINGLE CYLINDER AIR COMPRESSOR

dph-nr 1458180

IVECO

- 99440234
- 98422110
- 98421107
- 99440235

KNORR-BREMSE

- ACX67AAG - K007564
- ACX67BAG - K007569

VEHICLE APPLICATION

- 175
- 190
- 240
- 260
- 330



Repair Kit

dph-nr 1455154

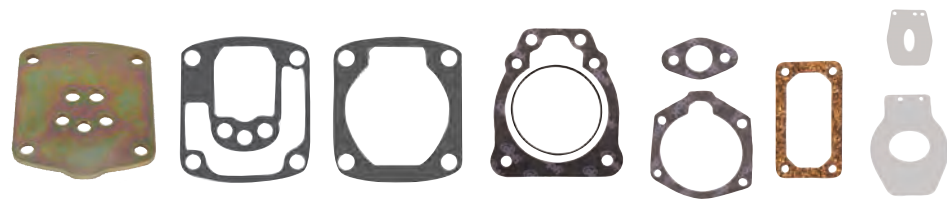

Repair Kit

dph-nr 1455150

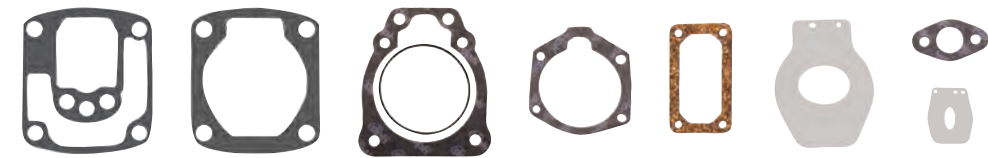

Repair Kit

dph-nr 1455151



Gasket Kit

dph-nr 1455152

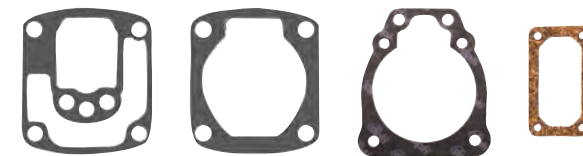

Complete Cylinderhead

dph-nr 1455155

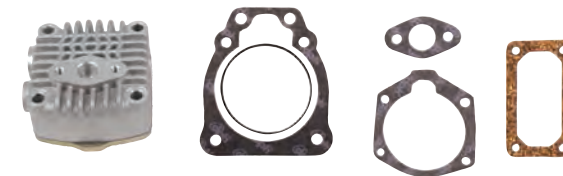

Valve Kit

dph-nr 1455153



All manufacturers names, numbers, symbols and descriptions are used for reference purposes only.



All manufacturers names, numbers, symbols and descriptions are used for reference purposes only.



IVECO

IVECO

IVECO

99440223
65256373
99440222
65006372
65006373

KNORR-BREMSE

AC63ZB
AC63ZA
AC63ZAG
AC63ZBG

VEHICLE APPLICATION

697
619
300PC
684

Repair Kit

dph-nr 1455161

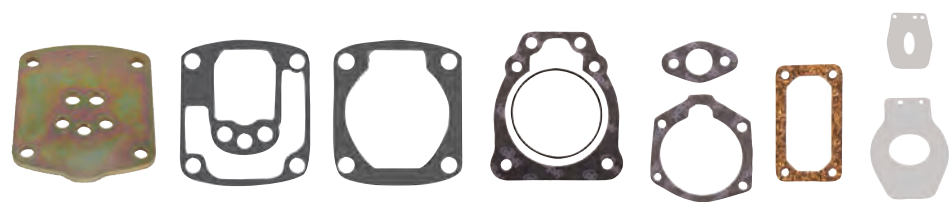

Repair Kit

dph-nr 1455156

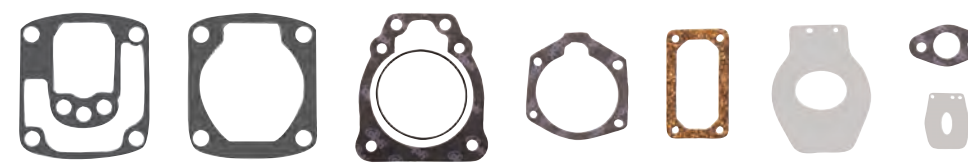

Repair Kit

dph-nr 1455157



Gasket Kit

dph-nr 1455158



Complete Cylinderhead

dph-nr 1455160

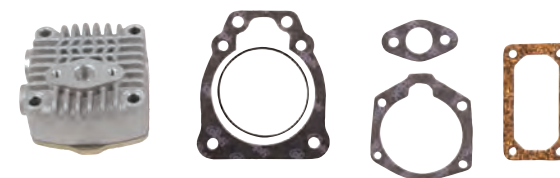

Valve Kit

dph-nr 1455159



IVECO

4860565
500329471
93199704
8023474
500310906

WABCO

911 506 050 0
911 506 053 0
911 506 054 0

VEHICLE APPLICATION

EURO TRAKKER
EURO CARGO 150E
320E
MP190 / MP260
MP340 / MP380
MP400 / MP410
MP440 / MP720
EUROTECH MT180

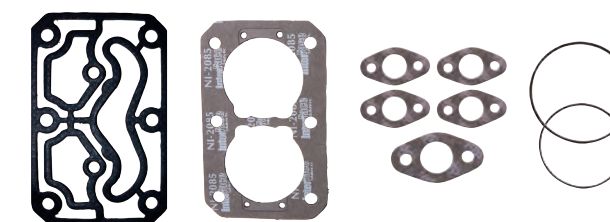
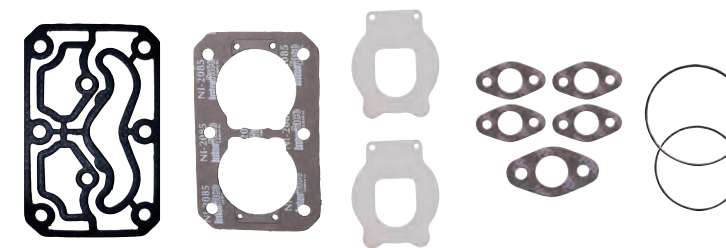
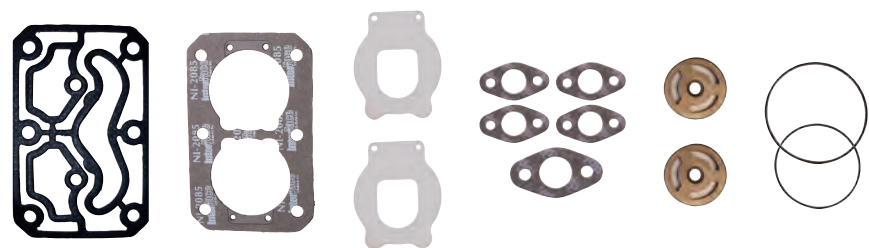



Dichtungspartner Hamburg

IVECO

SINGLE CYLINDER 88mm COMPRESSOR REPAIR KIT

SINGLE CYLINDER AIR COMPRESSOR

dph-nr 1458185

IVECO

- 01174474
- 01173720
- 01177290
- 01174519
- 01173793

KNORR-BREMSE

- LK3904
- LK3908



Complete Cylinderhead

dph-nr 1455169

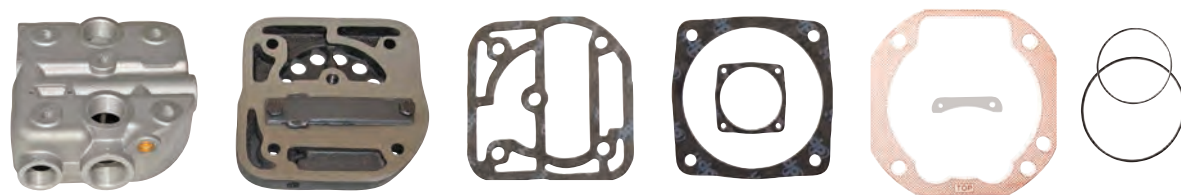

Full Repair Kit

dph-nr 1455168

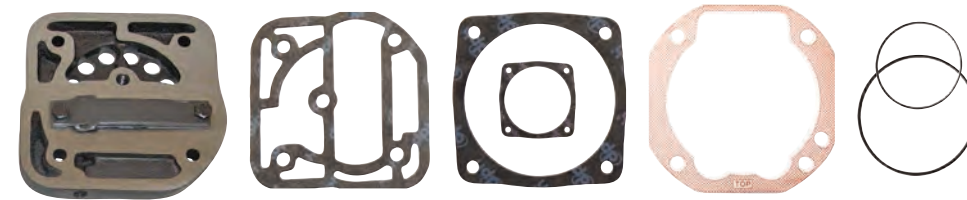

Repair Kit

dph-nr 1455165

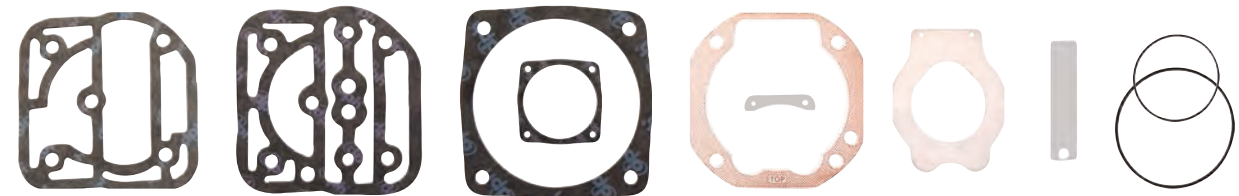

Repair Kit For Plate

dph-nr 1455166

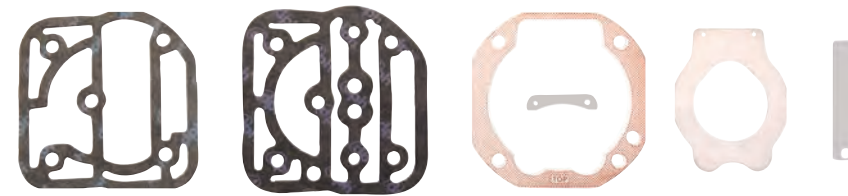

Gasket Kit

dph-nr 1455167

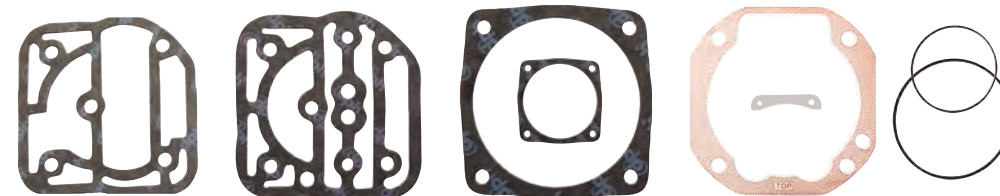

All manufacturers names, numbers, symbols and descriptions are used for reference purposes only.



All manufacturers names, numbers, symbols and descriptions are used for reference purposes only.



MAN



MAN

MAN

MAN

51.54100-7096

KNORR-BREMSE

LP3986 - K005977

VEHICLE APPLICATION

- TGA 18T D20/D26
- TGA 19T D20/D26
- TGA 26T D20/D26
- TGA 28T D20/D26
- TGA 32T D20/D26
- TGA 33T D20/D26
- TGA 35T D20/D26
- TGA 40T D20/D26
- TGA 41T D20/D26
- TGS 18T D20/D26
- TGS 26T D20/D26
- TGS 33T D20/D26
- TGS 35T D20/D26
- TGX 18T D20/D26
- TGX 26T D20/D26
- TGX 33T D20/D26
- NEOPLAN BUS



Complete Cylinderhead

dph-nr 1455176

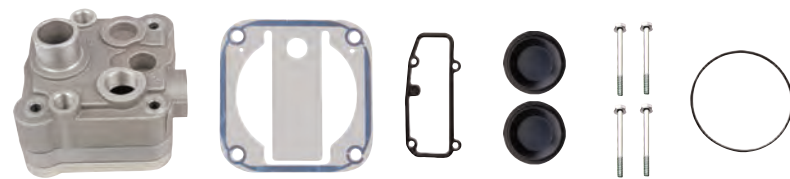

Full Repair Kit

dph-nr 1455171

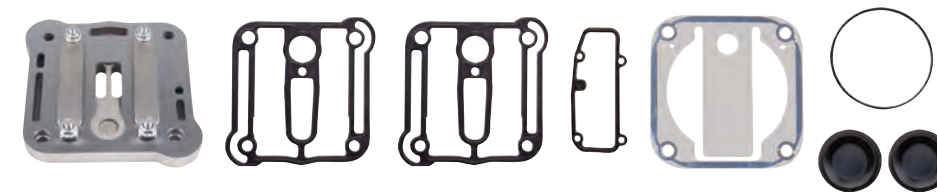

Valve Plate

dph-nr 1455175

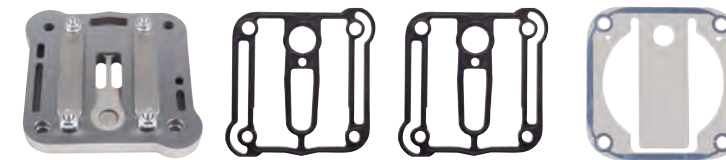

Repair Kit

dph-nr 1455170

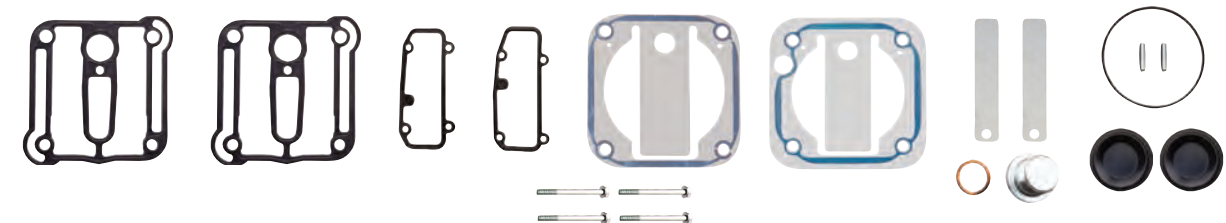

Gasket Kit

dph-nr 1455172

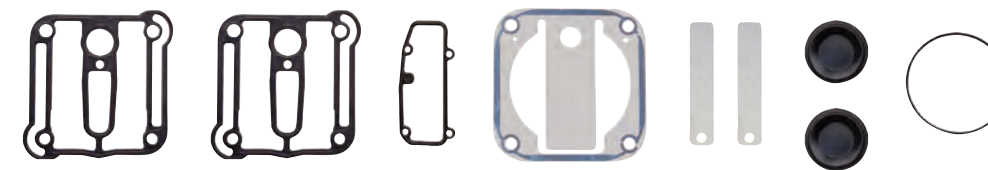

Gasket Kit

dph-nr 1455173

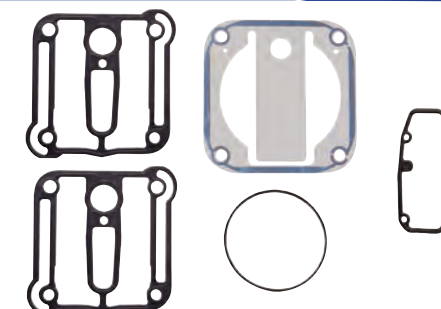

Valve Kit

dph-nr 1455174



MAN

51.54100-7095

KNORR-BREMSE

LP3980 - K004489

VEHICLE APPLICATION

TGA 18T D20/D26
TGA 19T D20/D26
TGA 26T D20/D26
TGA 28T D20/D26
TGA 32T D20/D26
TGA 33T D20/D26
TGA 35T D20/D26
TGA 40T D20/D26
TGA 41T D20/D26
TGS 18T D20/D26
TGS 26T D20/D26
TGS 33T D20/D26
TGS 35T D20/D26
TGX 18T D20/D26
TGX 26T D20/D26
TGX 33T D20/D26

STARLINER
CITYLINER
TOURLINER
SKYLINER
TRENDLINER
LION'S COACH
LION'S REGIO
LION'S CITY



Complete Cylinderhead

dph-nr 1455182



Full Repair Kit

dph-nr 1455177

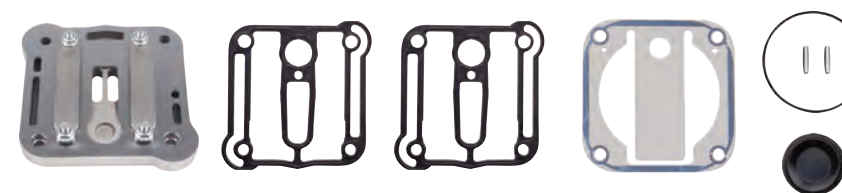

Full Repair Kit

dph-nr 1455181

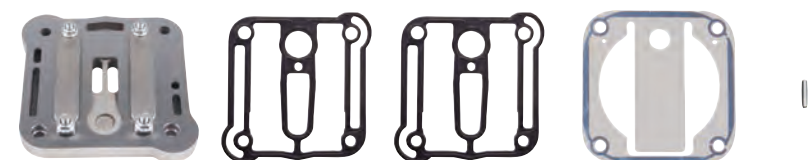

Repair Kit

dph-nr 1455170

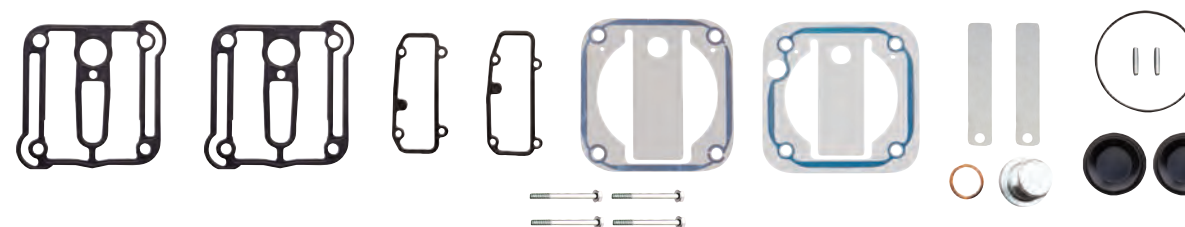

Gasket Kit

dph-nr 1455178

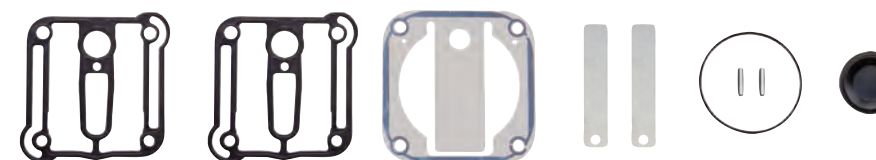

Gasket Kit

dph-nr 1455179

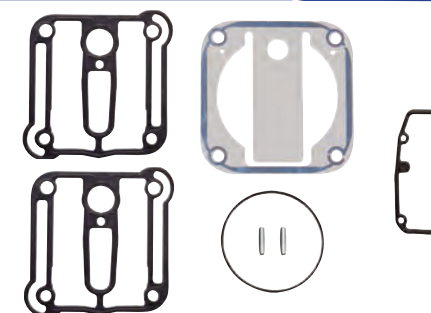

Valve Kit

dph-nr 1455180

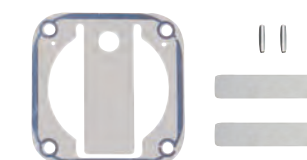

MAN

51.54100-7121

KNORR-BREMSE

LP3997 - K015948
LP3997 - K015948ES

VEHICLE APPLICATION

- | | |
|-----------------|--------------|
| TGA 18T D20/D26 | NEOPLAN BUS |
| TGA 19T D20/D26 | STARLINER |
| TGA 26T D20/D26 | CITYLINER |
| TGA 28T D20/D26 | TOURLINER |
| TGA 32T D20/D26 | SKYLINER |
| TGA 33T D20/D26 | TRENDLINER |
| TGA 35T D20/D26 | LION'S COACH |
| TGA 40T D20/D26 | LION'S REGIO |
| TGA 41T D20/D26 | LION'S CITY |
| TGS 18T D20/D26 | |
| TGS 26T D20/D26 | |
| TGS 33T D20/D26 | |
| TGS 35T D20/D26 | |
| TGX 18T D20/D26 | |
| TGX 26T D20/D26 | |
| TGX 33T D20/D26 | |



Complete Cylinderhead

dph-nr 1455187

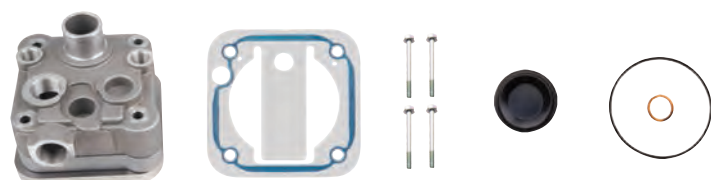

Full Repair Kit

dph-nr 1455186



Repair Kit

dph-nr 1455170

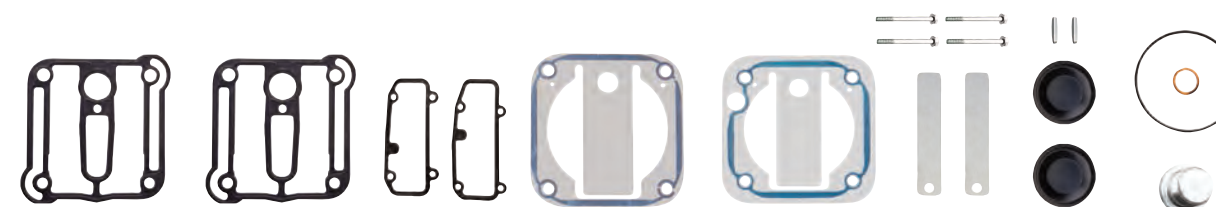

Repair Kit

dph-nr 1455183

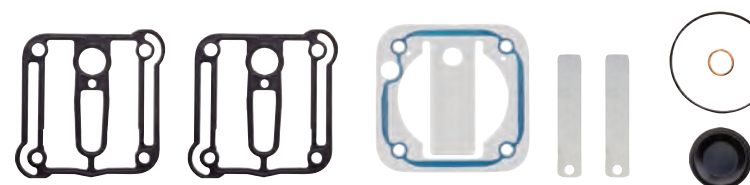

Gasket Kit

dph-nr 1455184



Valve Kit

dph-nr 1455185

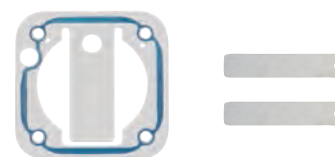

MAN

51.54100-7117

KNORR-BREMSE

LK8901 - K015410

VEHICLE APPLICATION

- | | |
|-----------------|--------------|
| TGA 18T D20/D26 | NEOPLAN BUS |
| TGA 19T D20/D26 | STARLINER |
| TGA 26T D20/D26 | CITYLINER |
| TGA 28T D20/D26 | TOURLINER |
| TGA 32T D20/D26 | SKYLINER |
| TGA 33T D20/D26 | TRENDLINER |
| TGA 35T D20/D26 | LION'S COACH |
| TGA 40T D20/D26 | LION'S REGIO |
| TGA 41T D20/D26 | LION'S CITY |
| TGS 18T D20/D26 | |
| TGS 26T D20/D26 | |
| TGS 33T D20/D26 | |
| TGS 35T D20/D26 | |
| TGX 18T D20/D26 | |
| TGX 26T D20/D26 | |
| TGX 33T D20/D26 | |



Complete Cylinderhead

dph-nr 1455192

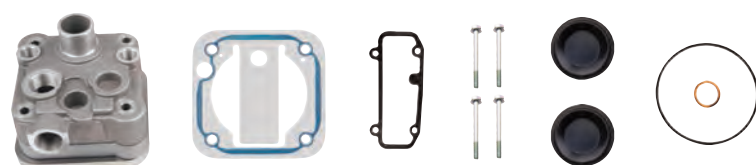

Full Repair Kit

dph-nr 1455191



Repair Kit

dph-nr 1455170



Repair Kit

dph-nr 1455188

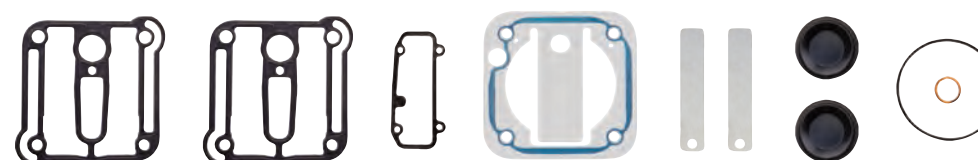

Gasket Kit

dph-nr 1455189

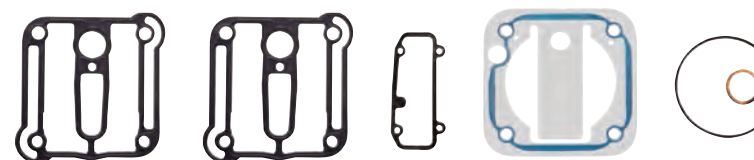

Valve Kit

dph-nr 1455190

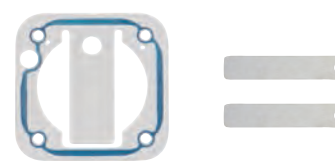

MAN

- 51.54100-6011
- 51.54100-6015
- 51.54100-6005
- 51.54100-6023
- 51.54100-7003

VEHICLE APPLICATION

- TGA 18T D28
- TGA 19T D28
- TGA 26T D28
- TGA 32T D28
- TGA 33T D28
- TGA 35T D28
- TGA 40T D28
- TGA 41T D28
- SL 202
- NL 202
- NL 232 CNG
- NG 232 CNG
- LIONS CITY
- NL 223
- NL 263
- NL 313

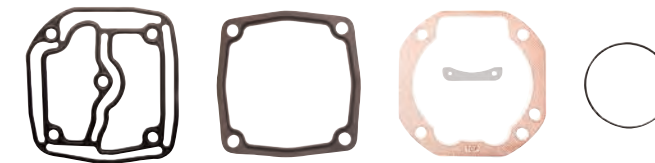

MAN

- 51.54100-6007
- 51.54100-6009
- 51.54100-7010
- 51.54100-7028
- 51.54100-7033

VEHICLE APPLICATION

TGA



Complete Cylinderhead

dph-nr 1455199

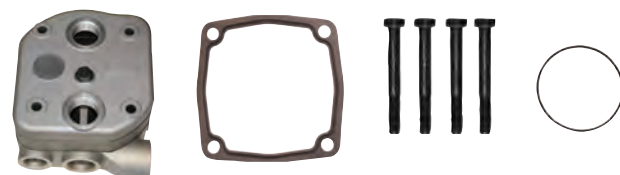

Repair Kit

dph-nr 1258896

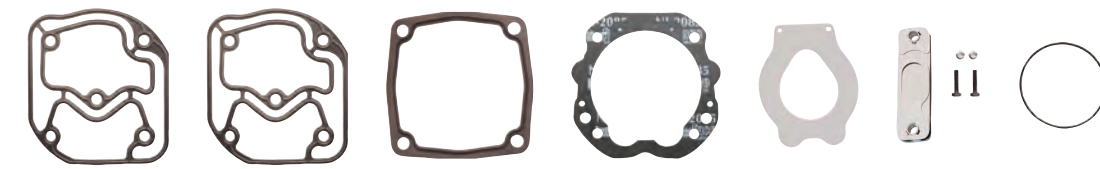

Gasket Kit

dph-nr 1455197

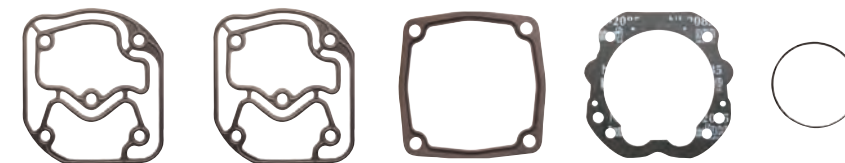

Valve Kit

dph-nr 1455198



MAN

51.54100-7005
51.54100-7070
51.54100-7071

WABCO

412 352 003 0
912 117 000 0
912 116 000 0

VEHICLE APPLICATION

TGL
TGM
LIONS CITY
LE 11/12
32270
D0834 ENGINE
D0836 ENGINE

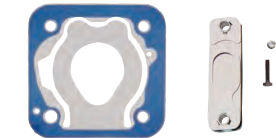
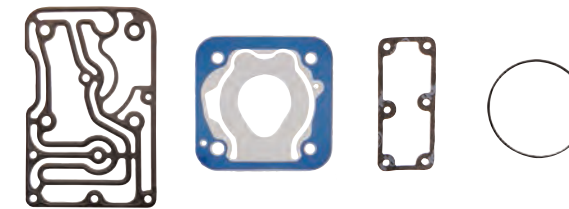
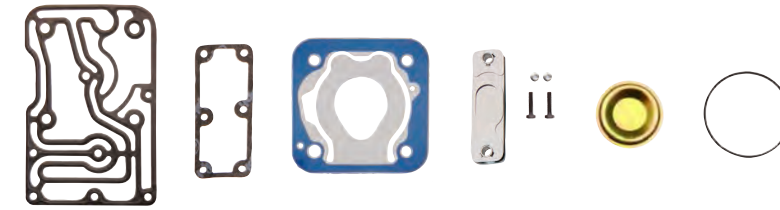

MAN

- 51.54101-7261
- 51.54101-7254
- 51.54101-7219
- 51.54101-7239
- 51.54101-9254

WABCO

- 911 514 001 0
- 911 514 002 0

VEHICLE APPLICATION

- 13220
- 18220
- 18250
- 19270
- 26270
- 25270
- 32310
- 32270
- D0826 ENGINE

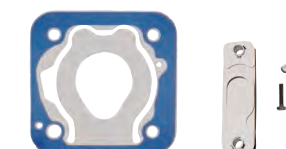
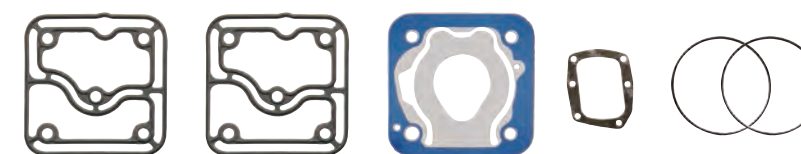

SINGLE CYLINDER AIR COMPRESSOR

MAN

51.54101-7240

WABCO

411 151 004 0

VEHICLE APPLICATION

- LE 8T
- LE 9T
- LE 10T
- LE 11T
- LE 12T
- LE 13T
- LE 14T
- LE 15T
- LE 18T
- LE 26T
- D0834 ENGINE
- D0836 ENGINE

Repair Kit

dph-nr 1455206



Gasket Kit

dph-nr 1455207



Valve Kit

dph-nr 1455208

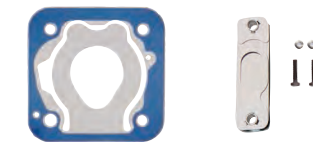

SINGLE CYLINDER AIR COMPRESSOR

MAN

WABCO

VEHICLE APPLICATION

2556
2566
2866

Repair Kit

dph-nr 1455209

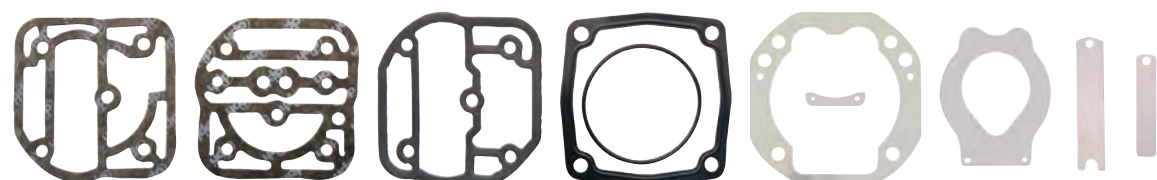

Gasket Kit

dph-nr 1455210

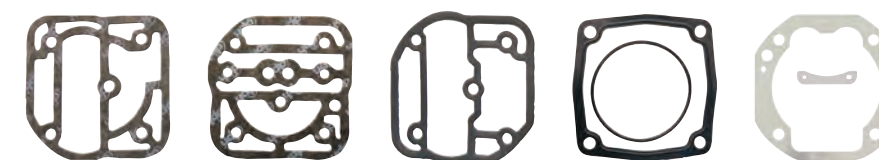

Valve Kit

dph-nr 1455211



MAN

- 51.54000-7086
- 51.54000-7121
- 51.54000-7127
- 51.54101-7140

WABCO

- 411 142 507 0
- 411 142 566 0
- 411 142 681 0
- 411 142 880 0
- 411 142 960 0
- 411 143 680 0
- 411 143 682 0
- 411 143 861 0
- 411 143 881 0

VEHICLE APPLICATION

- 19.422
- 26.281

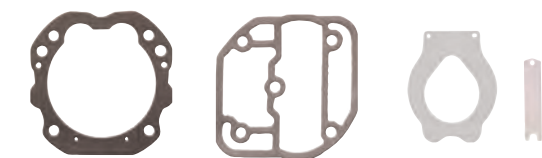
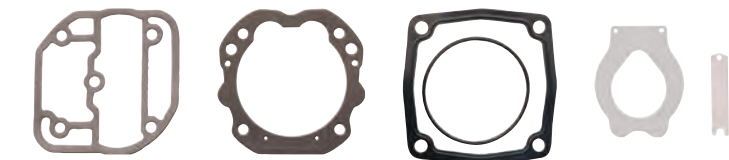
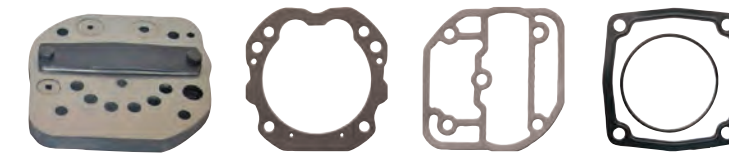
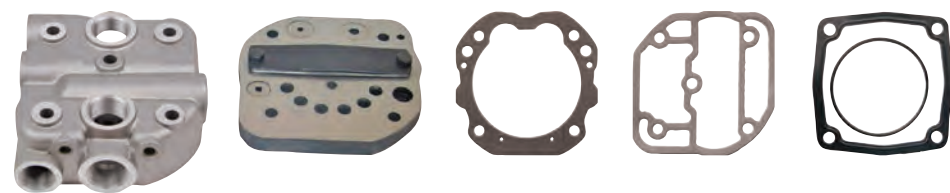

SINGLE CYLINDER AIR COMPRESSOR

MAN

WABCO

VEHICLE APPLICATION

2556
2566
2866

Repair Kit

dph-nr 1455217

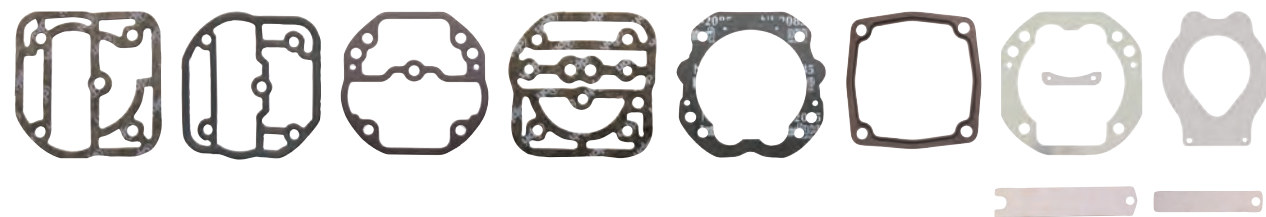

Gasket Kit

dph-nr 1455218

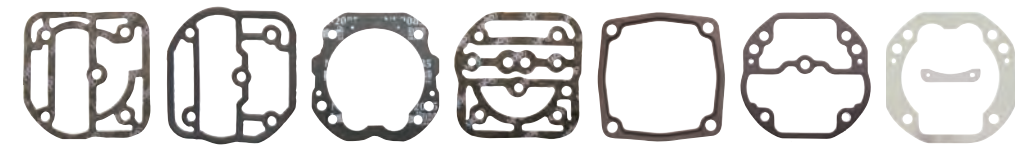

Valve Kit

dph-nr 1455219

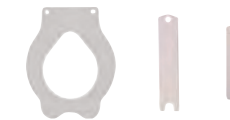

MAN

- 51.54100-7069
- 51.54101-7212
- 51.54101-7215
- 51.54000-6011
- 51.54000-6014
- 51.54000-6021
- 51.54101-7243
- 51.54101-9215
- 51.54100-7041

KNORR-BREMSE

- LK4908
- LK4911
- LK4932
- LK4939
- LK4913
- LK4909
- LK4910
- LK4912

VEHICLE APPLICATION

- | | |
|-------------------------|---------------|
| NEOPLAN CENTROLINER BUS | NG SERIES BUS |
| LIONS CITY BUS | NU SERIES BUS |
| LIONS CLASSIC BUS | SL SERIES BUS |
| NL SERIES BUS | SG SERIES BUS |
| | SU SERIES BUS |

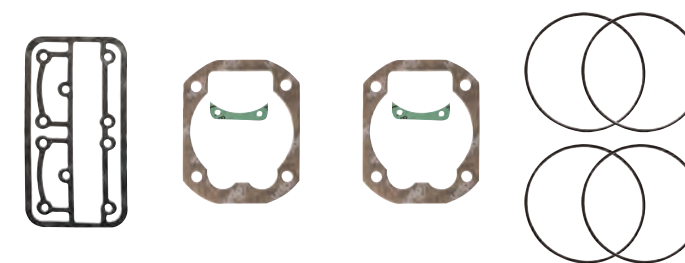
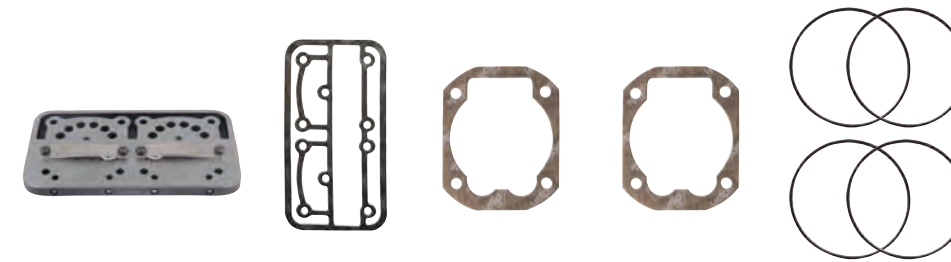
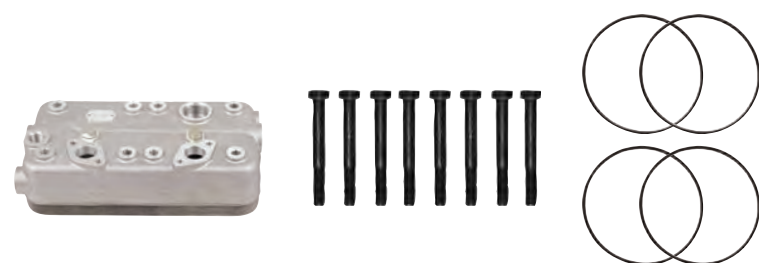

MAN

51.54101-7201
51.54101-7205
51.54101-7247

KNORR-BREMSE

LK3927

VEHICLE APPLICATION

26.230



Complete Cylinderhead

dph-nr 1455231

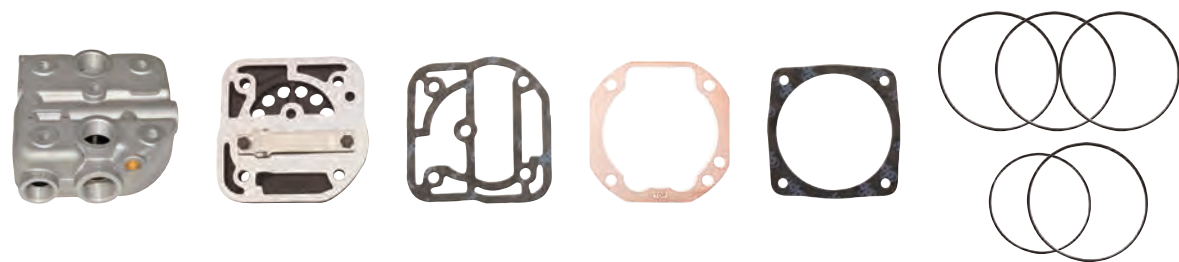

Full Repair Kit

dph-nr 1455229

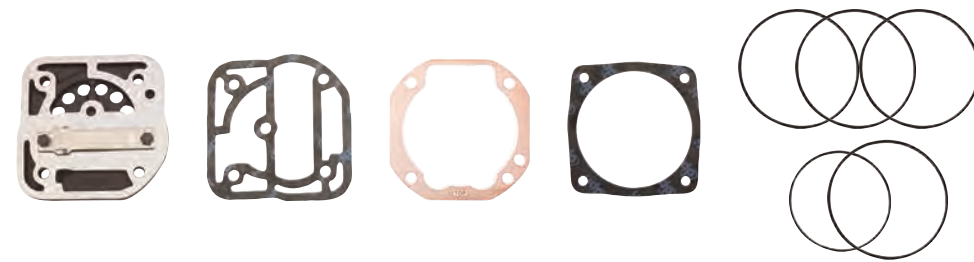

Valve Plate Kit

dph-nr 1455228



Valve Plate

dph-nr 1455230



Repair Kit

dph-nr 1455225



Repair Kit For Plate

dph-nr 1455226



Gasket Kit

dph-nr 1455227

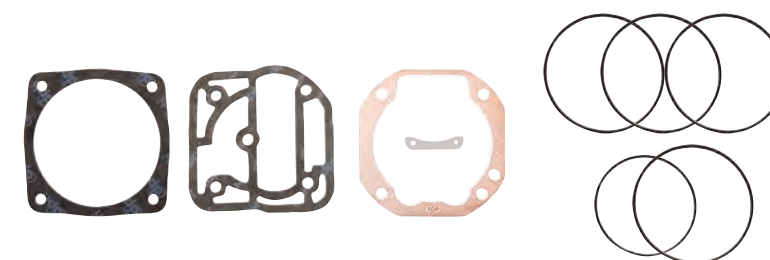

MAN

51.54101-7150

KNORR-BREMSE

VEHICLE
APPLICATION

2556
2566
2866

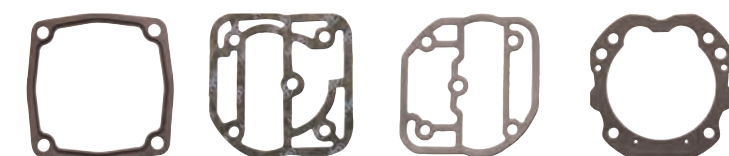
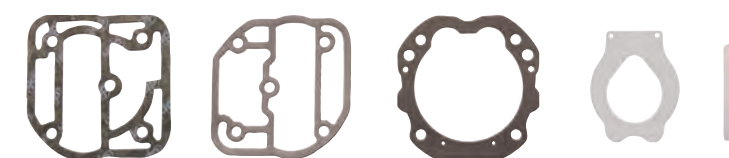

MAN

51.54000-7132
51.54000-7108

WABCO

VEHICLE
APPLICATION

DS2866

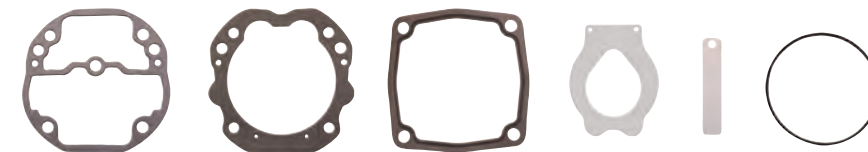
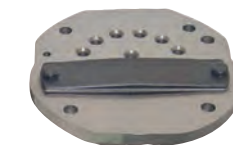
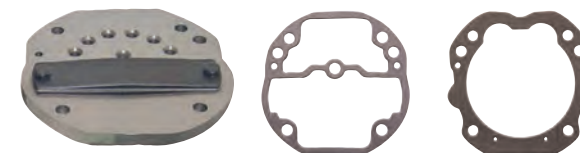
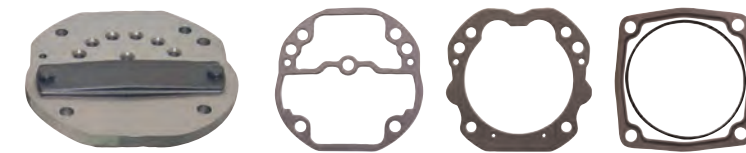
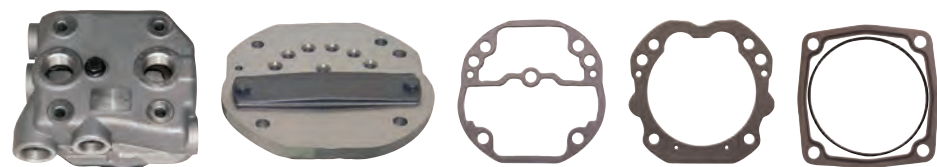

MAN

51.54000-7079

KNORR-BREMSE

K3812
LK3927

VEHICLE
APPLICATION

26.230



Complete Cylinderhead

dph-nr 1455244



Full Repair Kit

dph-nr 1455243



Valve Plate Kit

dph-nr 1455241



Valve Plate

dph-nr 1455242



Repair Kit

dph-nr 1455238

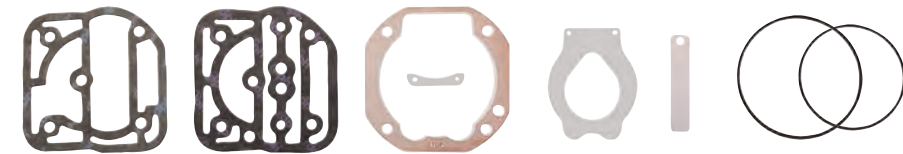

Repair Kit For Plate

dph-nr 1455239

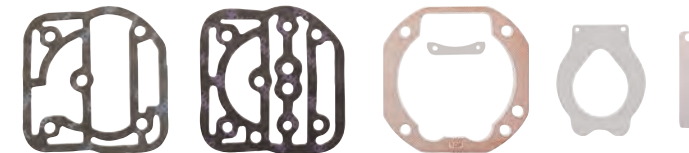

Gasket Kit

dph-nr 1455240



MAN

51.54101-7150

KNORR-BREMSE

VEHICLE
APPLICATION

2556
2566
2866



MAN

- 51.54101-7150
- 51.54101-7195
- 51.54101-7201
- 51.54101-7204
- 51.54101-7189

WABCO

- LK3802
- LK3805
- LK3806
- LK3808
- LK3809
- LK3826
- LK3832
- LP3830
- LP3928
- LP3934
- LP3940
- LP3943

VEHICLE APPLICATION

26.230



Complete Cylinderhead

dph-nr 1455254

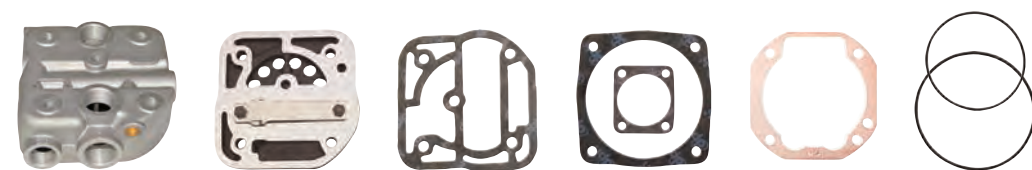

Full Repair Kit

dph-nr 1455253

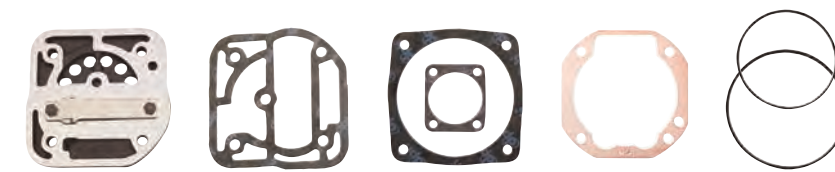

Valve Plate Kit

dph-nr 1455251



Valve Plate

dph-nr 1455252



Repair Kit

dph-nr 1455248



Repair Kit For Plate

dph-nr 1455249



Gasket Kit

dph-nr 1455250

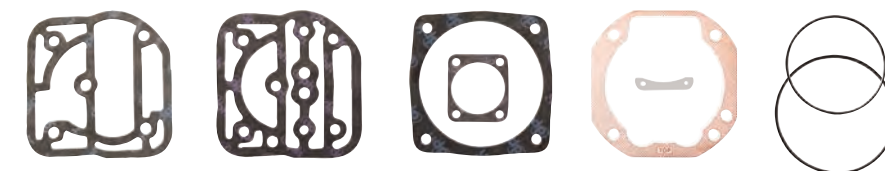

MAN

51.54000-7079

KNORR-BREMSE

VEHICLE
APPLICATION

19.422
26.281



Complete Cylinderhead

dph-nr 1455261

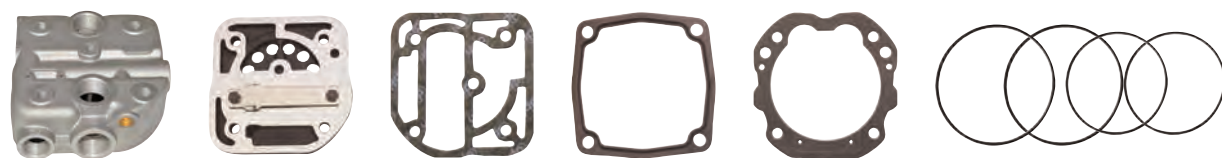

Full Repair Kit

dph-nr 1455260

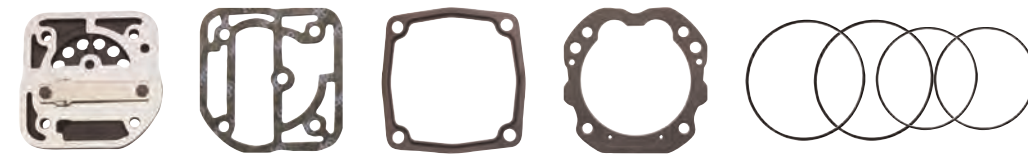

Valve Plate Kit

dph-nr 1455258



Valve Plate

dph-nr 1455259



Repair Kit

dph-nr 1455255

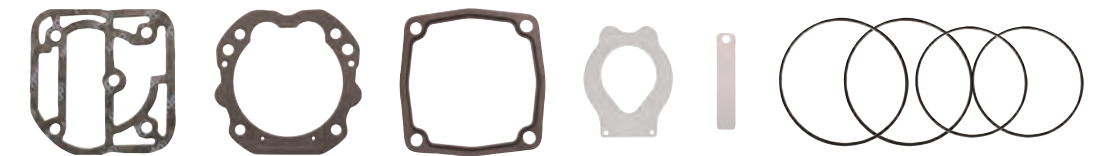

Repair Kit For Plate

dph-nr 1455256



Gasket Kit

dph-nr 1455257

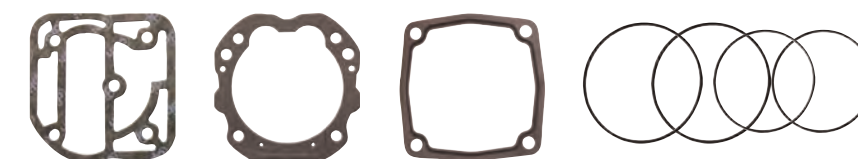

MERCEDES



MERCEDES BENZ

MERCEDES BENZ

MERCEDES BENZ

906 130 10 15
906 130 23 15
999 130 02 15

WABCO

411 553 000 0

VEHICLE APPLICATION

BUS



Complete Cylinderhead

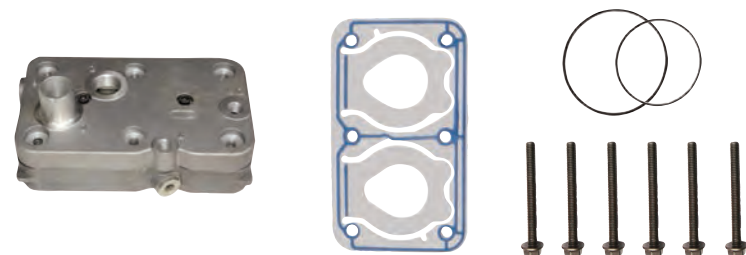

Repair Kit

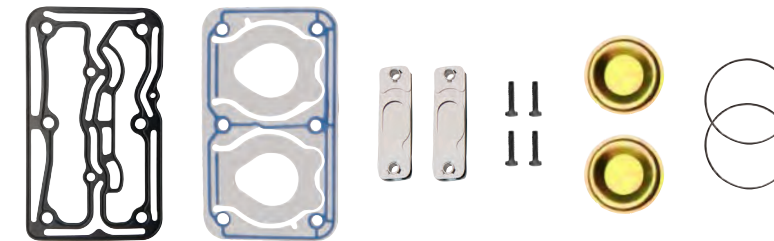

Gasket Kit

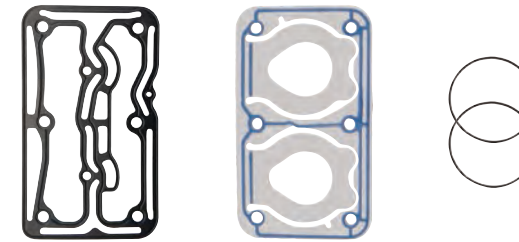

Valve Kit

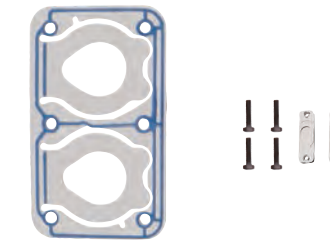

MERCEDES BENZ

- 457 130 12 15
- 457 130 18 15
- 457 130 19 15
- 457 130 22 15
- 457 130 25 15
- 457 130 27 15

WABCO

- 911 553 002 0
- 911 553 100 0
- 911 553 101 0
- 911 553 103 0
- 911 553 104 0
- 911 553 105 0

VEHICLE APPLICATION

AXOR



Complete Cylinderhead

dph-nr 1455272

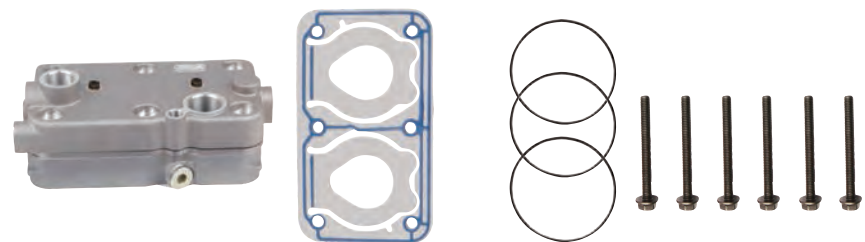

Valve Plate dph-nr 1455270



Gasket dph-nr 1458050



Repair Kit dph-nr 1455266

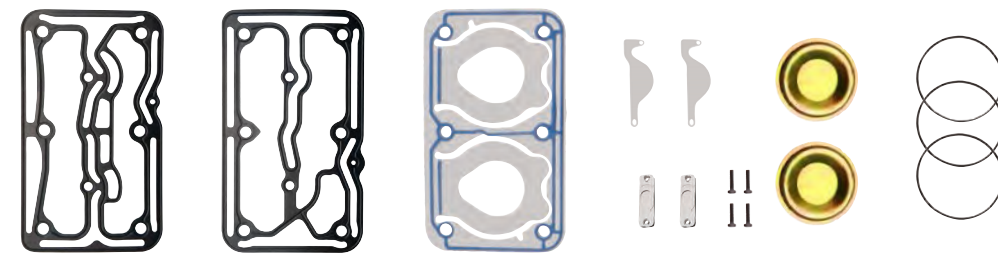

Head Repair Kit dph-nr 1455267

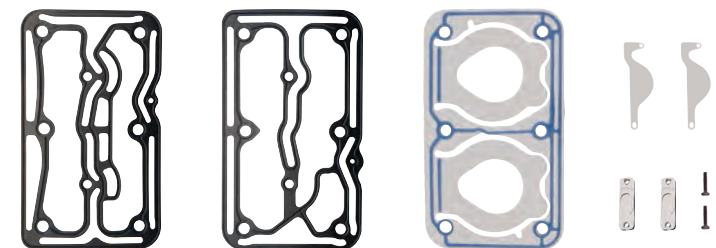

Gasket Kit dph-nr 1455268

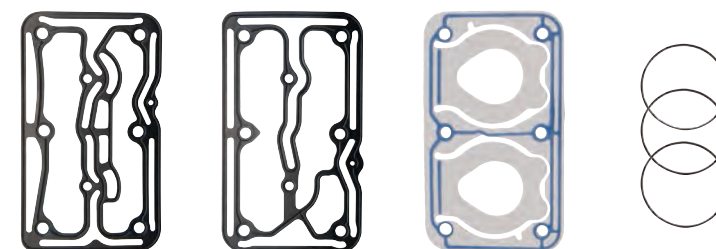

Valve Kit dph-nr 1455269

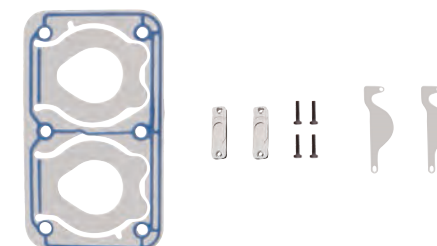

MERCEDES BENZ

457 130 29 15
457 130 47 15

WABCO

911 553 200 0
911 553 203 0

VEHICLE APPLICATION

TRAVEGO



Complete Cylinderhead

dph-nr 1455278

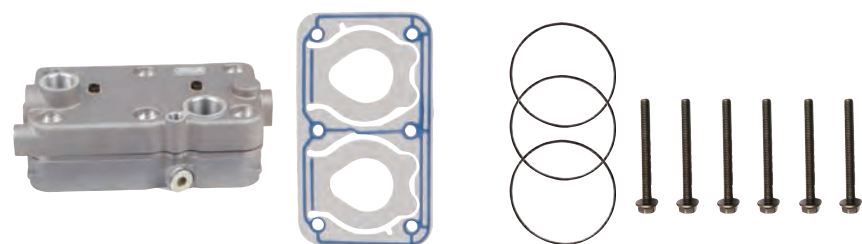

Valve Plate dph-nr 1455277



Valve Kit dph-nr 1455276

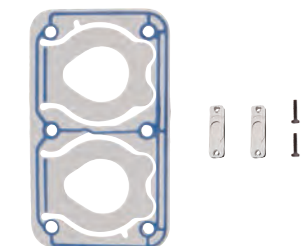

Repair Kit dph-nr 1455273

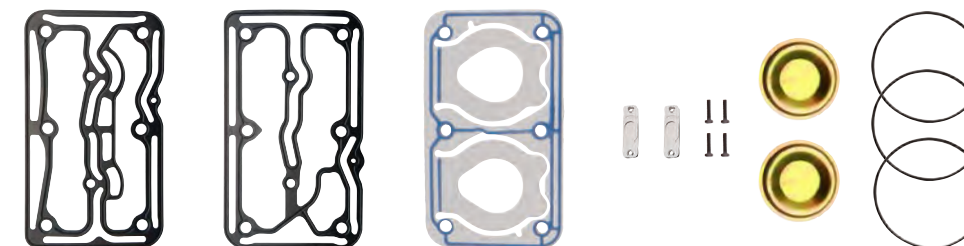

Head Repair Kit dph-nr 1455274

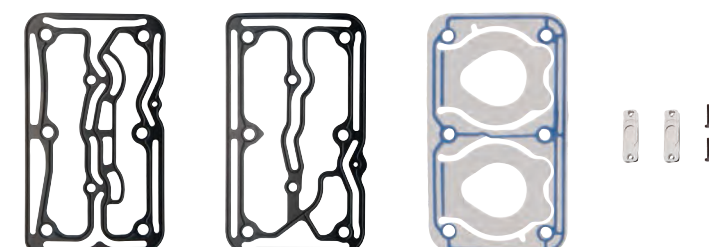

Gasket Kit dph-nr 1455275

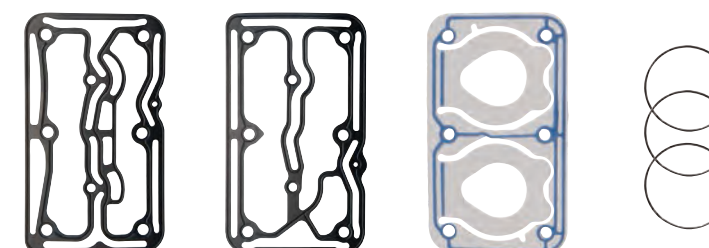

MERCEDES BENZ

- 457 130 08 15
- 457 130 11 15
- 457 130 16 15
- 457 130 17 15
- 457 130 21 15
- 457 130 23 15
- 457 130 24 15

WABCO

- 412 352 006 0
- 412 352 007 0
- 412 352 010 0
- 412 352 011 0
- 412 352 013 0
- 412 352 014 0
- 412 352 015 0

VEHICLE APPLICATION

- AXOR
- TRAVEGO

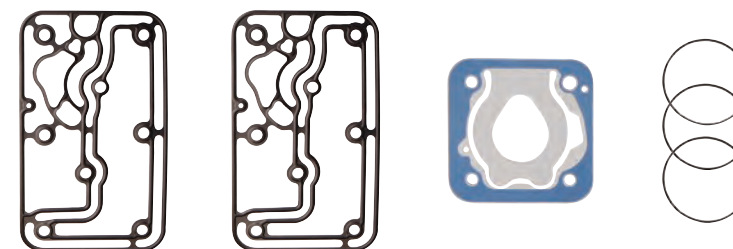
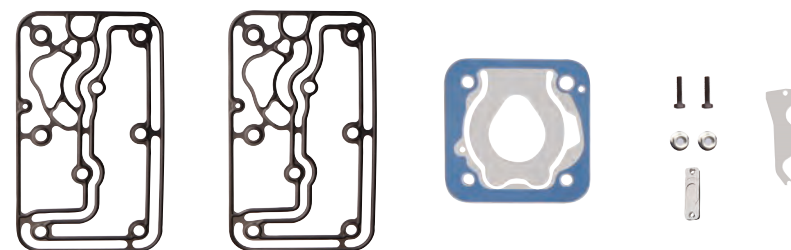
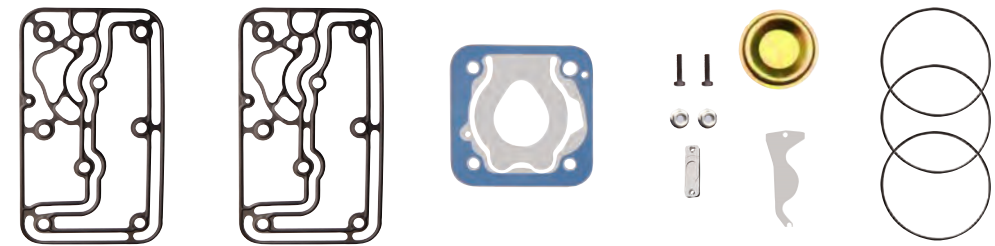
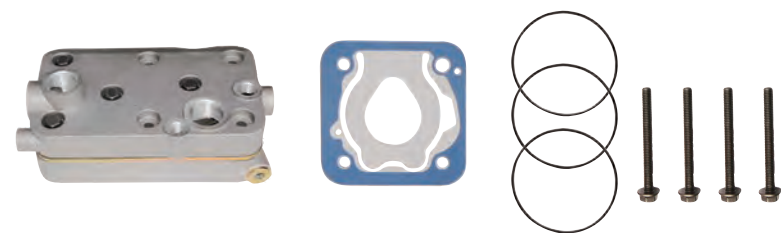

MERCEDES BENZ

457 130 44 15
457 130 45 15

WABCO

412 352 026 0
412 352 027 0

VEHICLE APPLICATION

AXOR
TRAVEGO



Complete Cylinderhead

dph-nr 145288



Valve Plate dph-nr 1455282



Valve Kit dph-nr 1455287



Repair Kit dph-nr 1455284

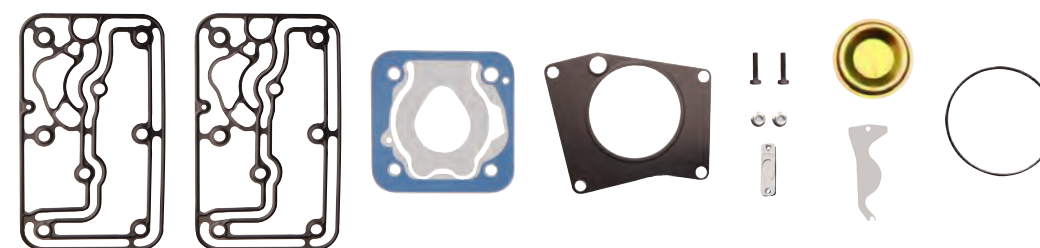

Head Repair Kit dph-nr 1461528

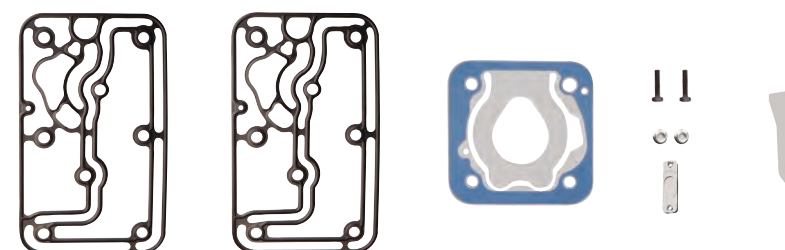

Gasket Kit dph-nr 1455286

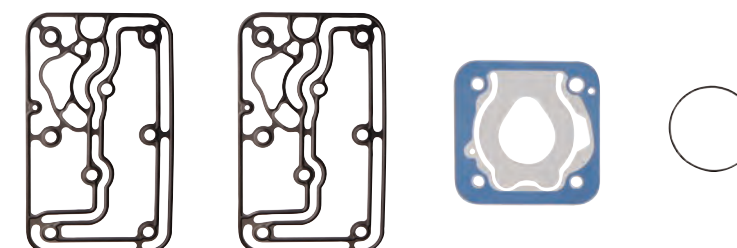

MERCEDES BENZ

- 906 130 07 15
- 906 130 11 15
- 906 130 12 15
- 906 130 28 15
- 906 130 29 15
- 906 130 41 15
- 906 130 42 15

WABCO

- 411 151 003 0
- 411 151 008 0
- 411 154 000 0
- 411 154 003 0

VEHICLE APPLICATION

- AXOR
- ATEGO



Complete Cylinderhead

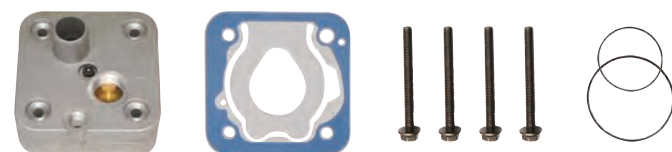

Repair Kit



Gasket Kit

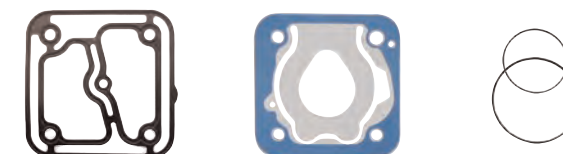

Valve Kit

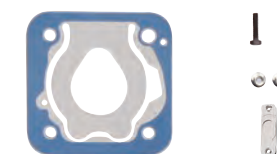

MERCEDES BENZ

906 130 49 15
906 130 51 15

WABCO

411 154 004 0
411 154 005 0

VEHICLE APPLICATION

AXOR
ATEGO



Repair Kit

dph-nr 1455293

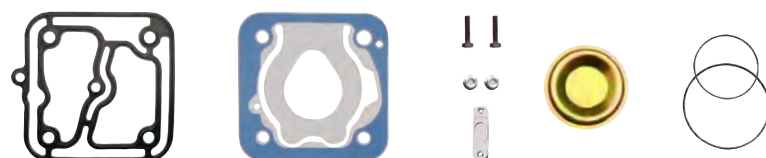

Gasket Kit

dph-nr 1455294

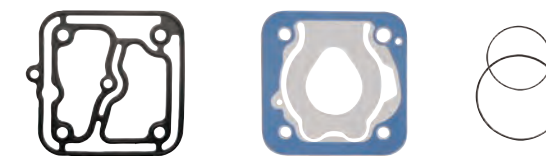

Valve Kit

dph-nr 1455295

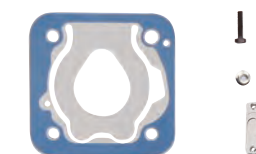

MERCEDES BENZ

WABCO

VEHICLE APPLICATION

ACTROS
SETRA
EVO BUS



Full Repair Kit

dph-nr 1455301

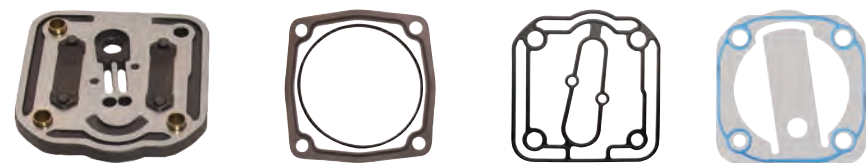

Valve Plate Kit dph-nr 1455299

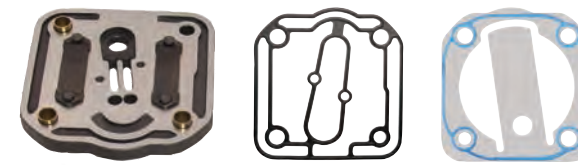

Cylinderhead dph-nr 1455302



Valve Plate dph-nr 1455300



Repair Kit For Plate dph-nr 1455298

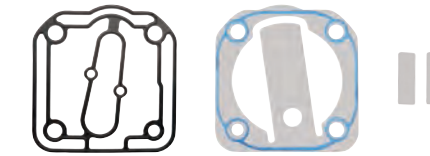

Repair Kit dph-nr 1455296

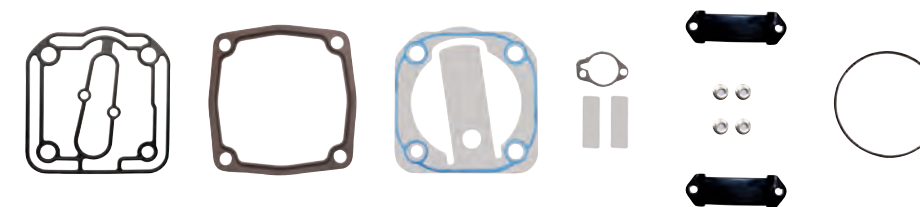

Repair Kit dph-nr 1455297

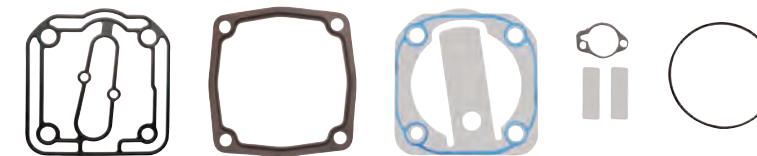

Gasket Kit dph-nr 1258893

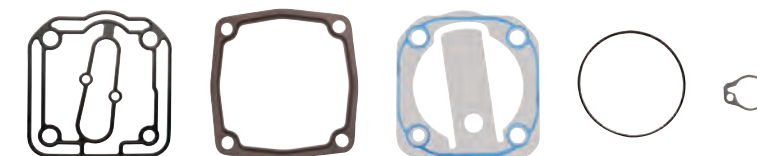

SINGLE CYLINDER AIR COMPRESSOR

MERCEDES BENZ

-

WABCO

-

VEHICLE APPLICATION

ACTROS
SETRA
EVO BUS

Repair Kit

dph-nr 1455303

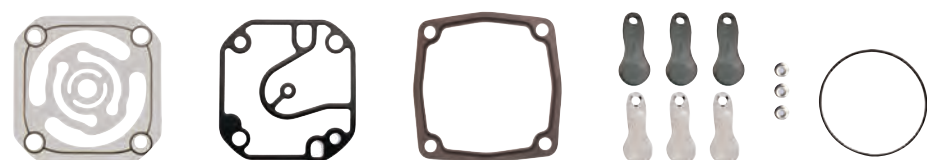

Repair Kit

dph-nr 1258892

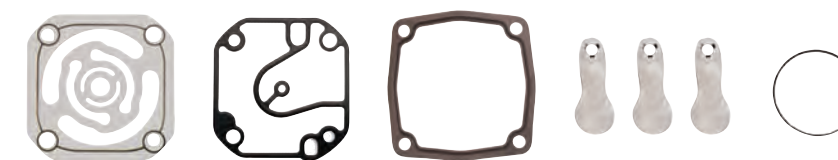

Repair Kit For Plate

dph-nr 1455304



Gasket Kit

dph-nr 1455305



MERCEDES BENZ

WABCO

VEHICLE APPLICATION

ACTROS
SETRA
EVO BUS



Full Repair Kit

dph-nr 1455307

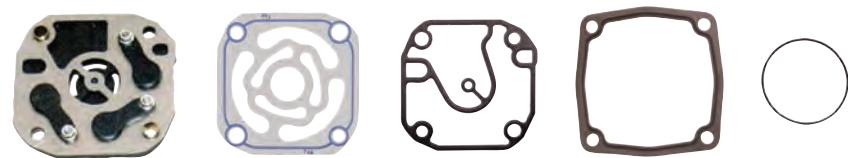

Valve Plate Kit dph-nr 1455310

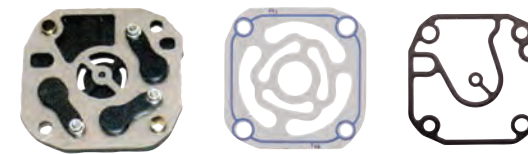

Valve Plate dph-nr 1455311



Repair Kit

dph-nr 1455306

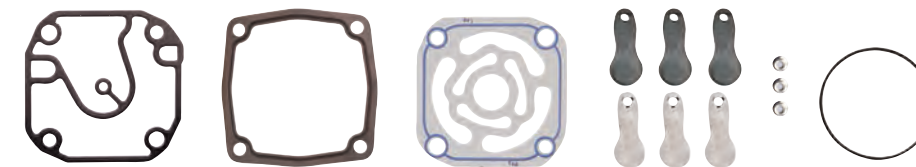

Repair Kit

dph-nr 1258891

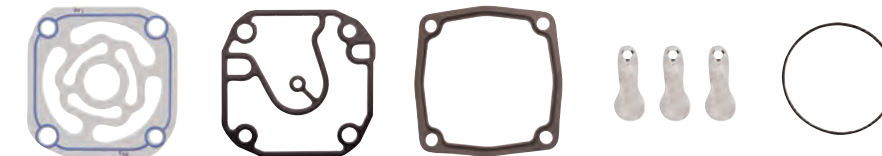

Gasket Kit

dph-nr 1455308

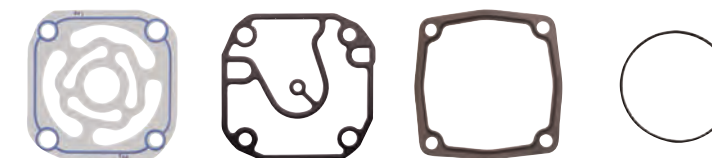

Repair Kit For Plate

dph-nr 1455309



MERCEDES BENZ

447 130 28 15

WABCO

VEHICLE APPLICATION

EURO 1 BUS
O345
O345K

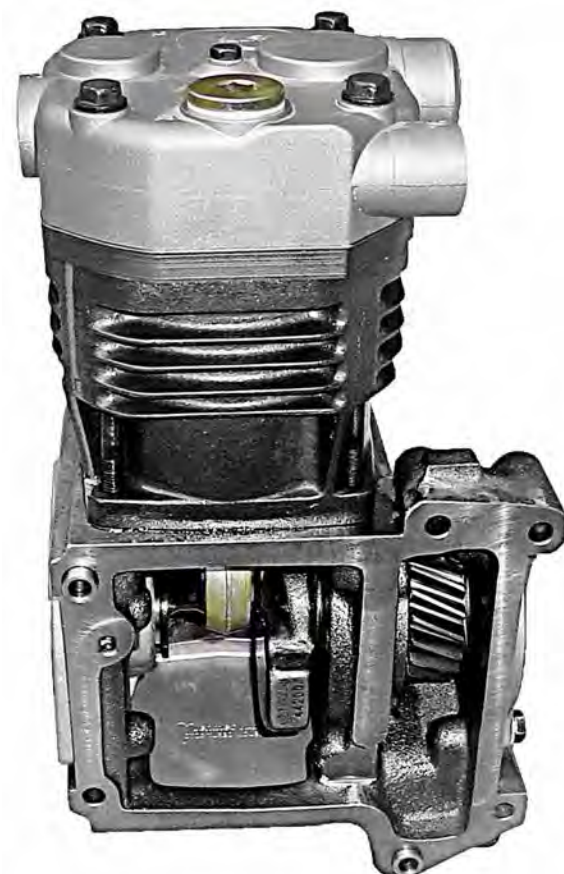

Full Repair Kit

dph-nr 1455313

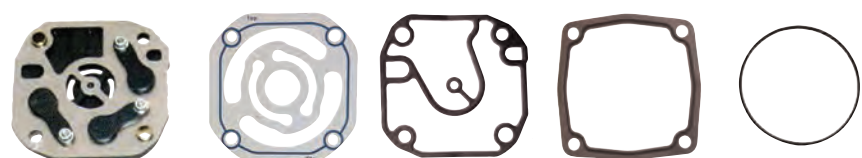

Valve Plate Kit dph-nr 1455316

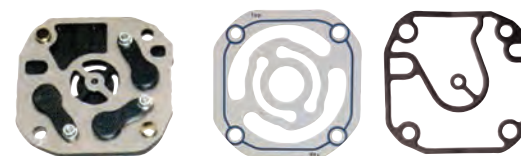

Cylinderhead dph-nr 1455318



Valve Plate dph-nr 1455317



Repair Kit For Plate dph-nr 1455315

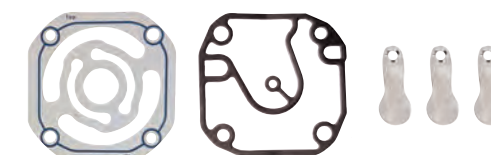

Repair Kit dph-nr 1455312

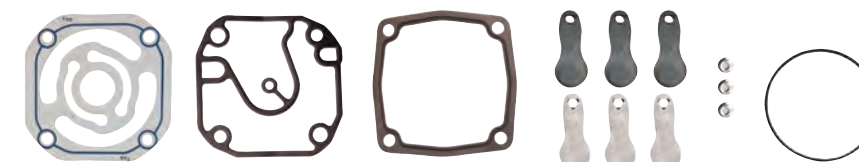

Repair Kit dph-nr 1258892

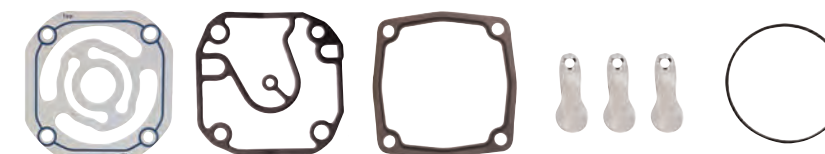

Gasket Kit dph-nr 1455314

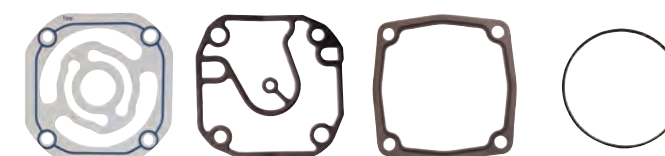

MERCEDES BENZ

WABCO

VEHICLE APPLICATION

- OM 401
- OM 402
- OM 421
- OM 422
- OM 423
- OM 440
- OM 441
- OM 442
- OM 443
- OM 447
- 3031
- 304
- 403

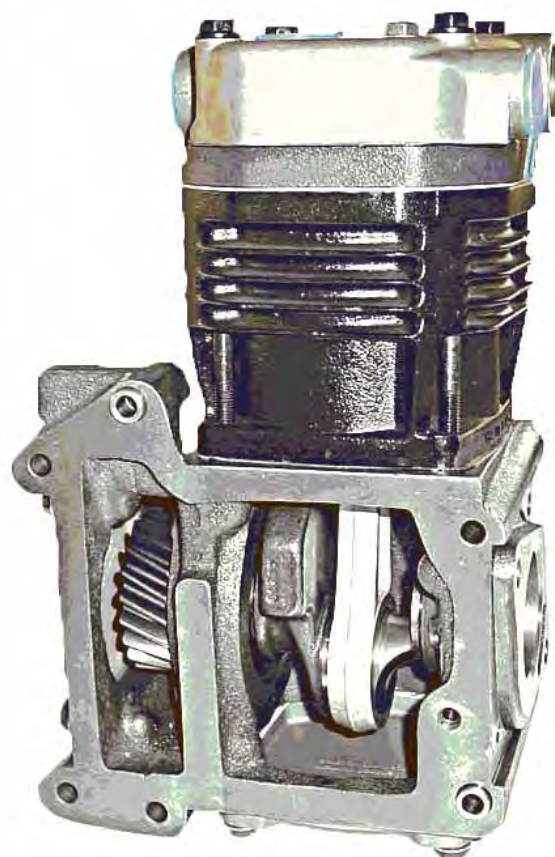

Full Repair Kit

dph-nr 1455320

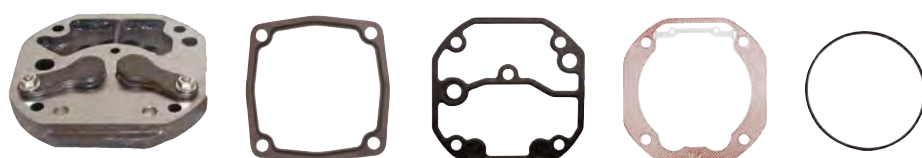

Valve Plate Kit dph-nr 1455323

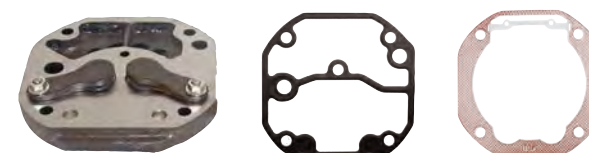

Cylinderhead dph-nr 1455325



Valve Plate dph-nr 1455324



Repair Kit For Plate dph-nr 1455321



Repair Kit dph-nr 1455319

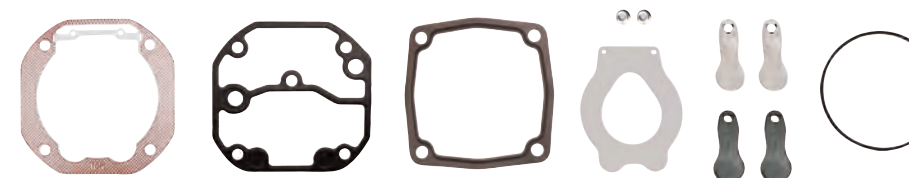

Repair Kit dph-nr 1258883

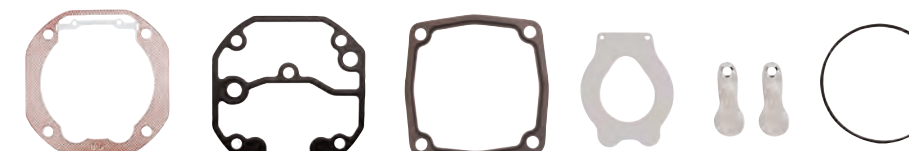

Gasket Kit dph-nr 1455322

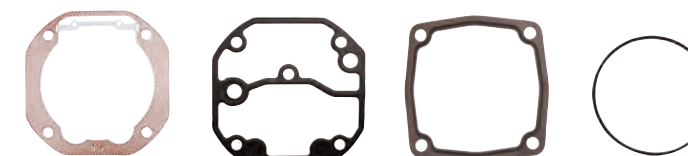

MERCEDES BENZ

KNORR-BREMSE

VEHICLE APPLICATION

LK38



Full Repair Kit

dph-nr 1455326



Valve Plate Kit dph-nr 1455329

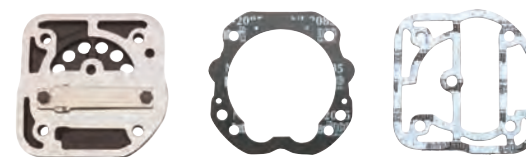

Cylinderhead dph-nr 1455331



Valve Plate dph-nr 1455330



Repair Kit For Plate dph-nr 1455328



Repair Kit

dph-nr 1258890

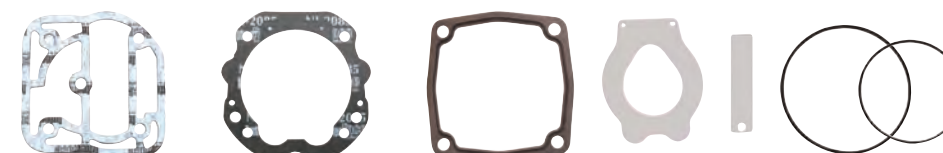

Gasket Kit

dph-nr 1455327

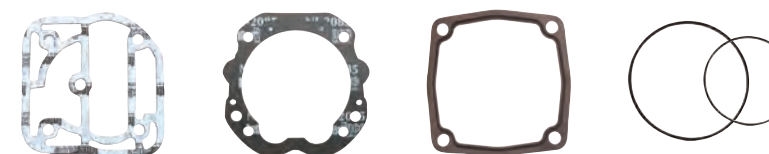

MERCEDES BENZ

407 130 05 15

KNORR-BREMSE

VEHICLE APPLICATION

- OM 401
- OM 402
- OM 403
- OM 407
- OM 421
- OM 423
- OM 427
- OM 440
- OM 441
- OM 442
- OM 447



Full Repair Kit

dph-nr 1455332



Valve Plate Kit dph-nr 1455334



Cylinderhead dph-nr 1455336



Valve Plate dph-nr 1455335



Repair Kit For Plate dph-nr 1455333



Repair Kit dph-nr 1258885



MERCEDES BENZ

407 130 05 15

KNORR-BREMSE

VEHICLE APPLICATION

- OM 401
- OM 402
- OM 403
- OM 407
- OM 421
- OM 423
- OM 427
- OM 440
- OM 441
- OM 442
- OM 447



Full Repair Kit

dph-nr 1455337

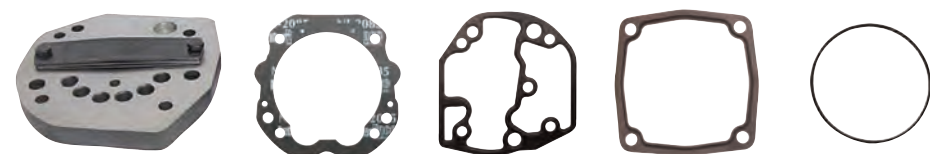

Valve Plate Kit dph-nr 1455339



Cylinderhead dph-nr 1455341



Valve Plate dph-nr 1455340



Repair Kit For Plate dph-nr 1455338



Repair Kit dph-nr 1258884



APPLICATION

MERCEDES

OEM NUMBER

407 130 05 15

- OM 401
- OM 402
- OM 403
- OM 407
- OM 421
- OM 423
- OM 427
- OM 440
- OM 441
- OM 442
- OM 447



Full Repair Kit

dph-nr 1455342

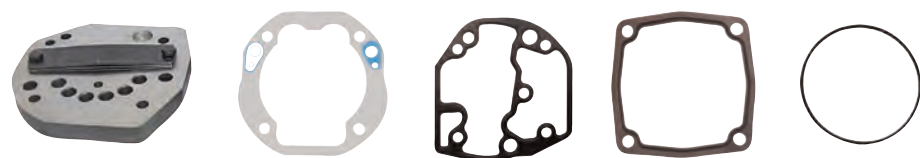

Valve Plate Kit dph-nr 1455344



Cylinderhead dph-nr 1455346



Valve Plate dph-nr 1455345



Repair Kit For Plate dph-nr 1455343



Repair Kit dph-nr 1455498

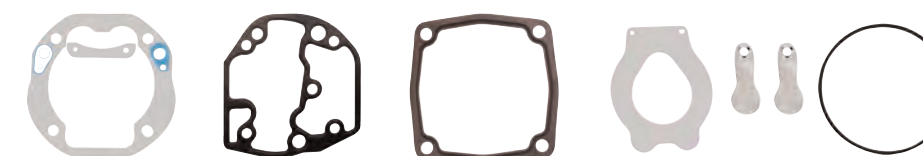

MERCEDES BENZ

407 130 05 15

KNORR-BREMSE

VEHICLE APPLICATION

- OM 401
- OM 402
- OM 403
- OM 407
- OM 421
- OM 423
- OM 427
- OM 440
- OM 441
- OM 442
- OM 447



Full Repair Kit

dph-nr 1455347

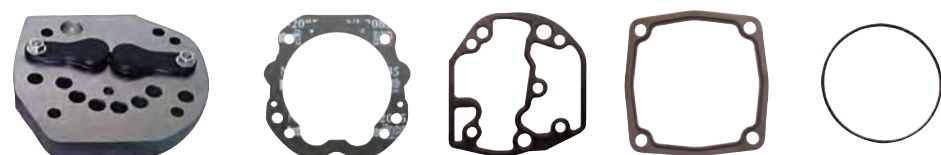

Valve Plate Kit dph-nr 1455349

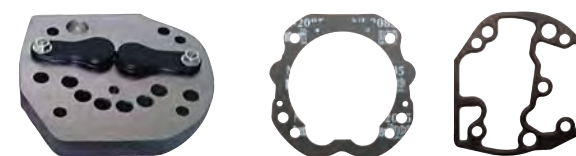

Cylinderhead dph-nr 1455351



Valve Plate dph-nr 1455350



Repair Kit For Plate dph-nr 1455348



Repair Kit dph-nr 1424698





Dichtungspartner Hamburg

MERCEDES BENZ

COMPRESSOR REPAIR KIT 90mm OM 401 & 404 OLD MODEL

SINGLE CYLINDER AIR COMPRESSOR

dph-nr 1458805

MERCEDES BENZ

407 130 05 15
496 130 00 15

KNORR-BREMSE

VEHICLE APPLICATION

- OM 401
- OM 402
- OM 403
- OM 407
- OM 421
- OM 422
- OM 423
- OM 427
- OM 440
- OM 441
- OM 442



Full Repair Kit

dph-nr 1455352

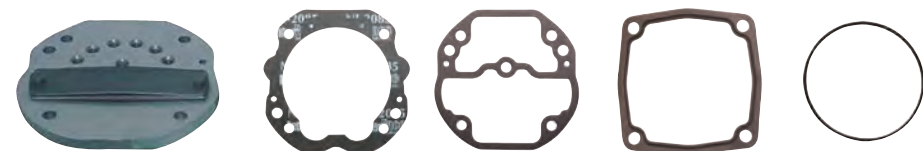

Valve Plate Kit dph-nr 1455354



Cylinderhead dph-nr 1455356



Valve Plate dph-nr 1455355



Repair Kit For Plate dph-nr 1455353

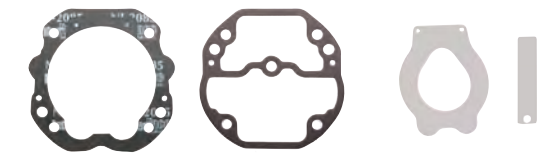

Repair Kit dph-nr 1455500

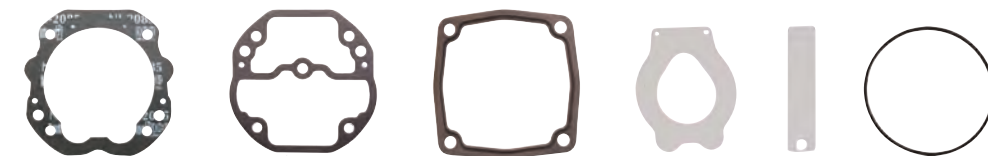

All manufacturers names, numbers, symbols and descriptions are used for reference purposes only.



All manufacturers names, numbers, symbols and descriptions are used for reference purposes only.





Dichtungspartner Hamburg

MERCEDES BENZ

COMPRESSOR REPAIR KIT 90mm OM 401 & 404 OLD MODEL

SINGLE CYLINDER AIR COMPRESSOR

dph-nr 1458806

MERCEDES BENZ

407 130 05 15
496 130 00 15

KNORR-BREMSE

VEHICLE APPLICATION

- OM 401
- OM 402
- OM 403
- OM 407
- OM 421
- OM 422
- OM 423
- OM 427
- OM 440
- OM 441
- OM 442



Full Repair Kit

dph-nr 1455357

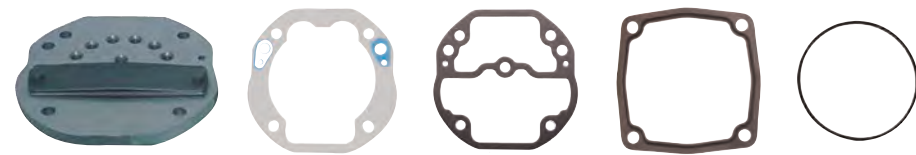

Valve Plate Kit dph-nr 1455359



Cylinderhead dph-nr 1455361



Valve Plate dph-nr 1455360



Repair Kit For Plate dph-nr 1461278

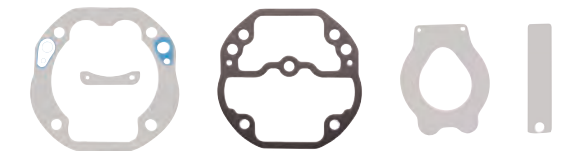

Repair Kit dph-nr 1455499



All manufacturers names, numbers, symbols and descriptions are used for reference purposes only.



All manufacturers names, numbers, symbols and descriptions are used for reference purposes only.



MERCEDES BENZ

MERCEDES BENZ

MERCEDES BENZ

- 001 131 52 01
- 001 131 54 01
- 001 131 55 01
- 002 131 36 01

WABCO

- 411 034 501 0
- 411 034 531 0
- 411 034 541 0
- 411 034 546 0
- 411 034 547 0
- 411 034 561 0

VEHICLE APPLICATION

- OM 327
- OM 355
- OM 356
- OM 360
- OM 366

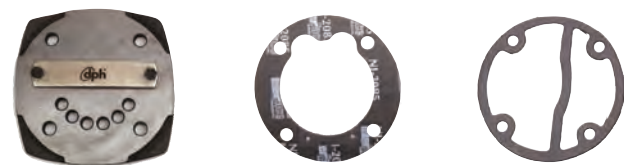
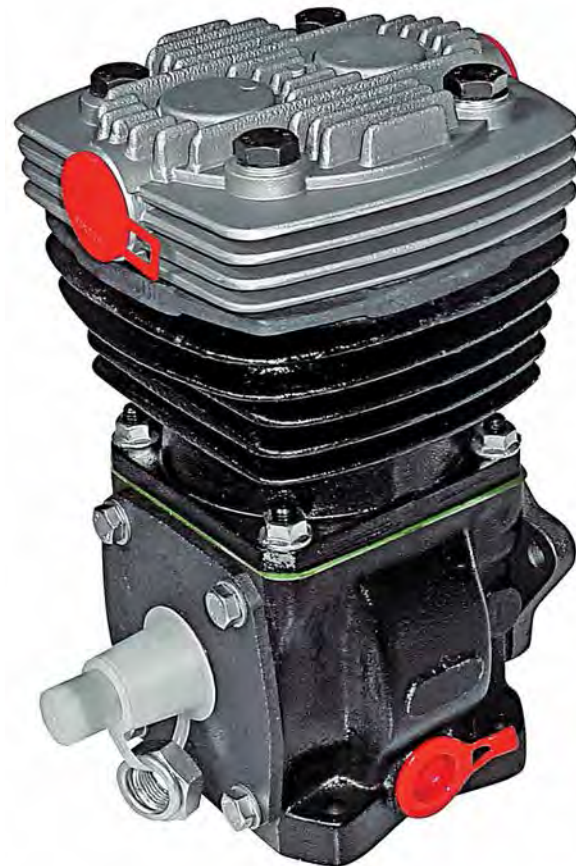

MERCEDES BENZ

003 13151 01
004 131 83 01

WABCO

411 142 507 0
411 142 566 0
411 142 681 0
411 142 880 0
411 142 960 0
411 143 680 0
411 143 682 0
411 143 861 0
411 143 881 0

VEHICLE APPLICATION

Unimog OM 364

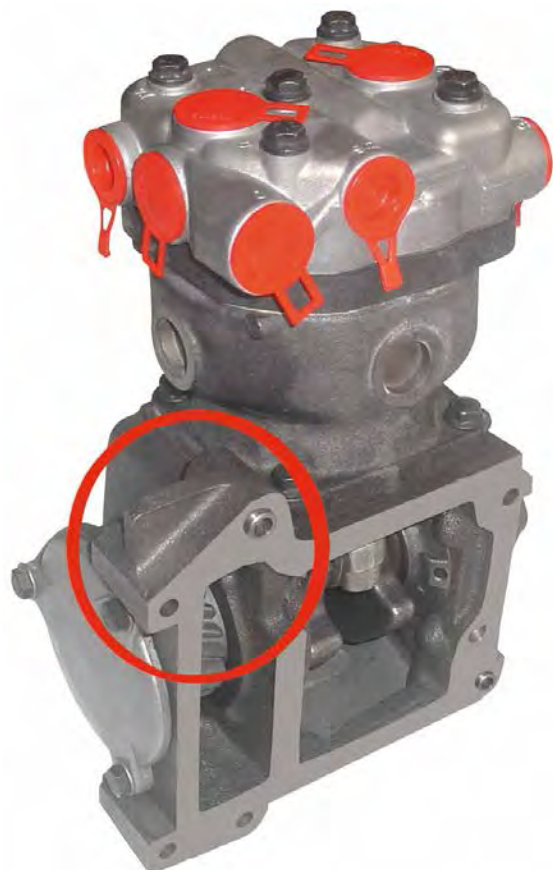

Valve Plate Kit

dph-nr 1455369

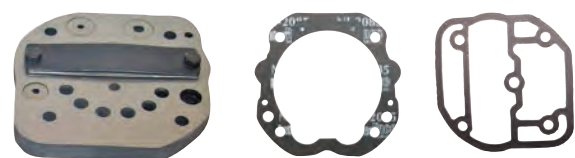

Valve Plate

dph-nr 1455370



Cylinderhead

dph-nr 1455371



Repair Kit

dph-nr 1424689



Gasket Kit

dph-nr 1455367

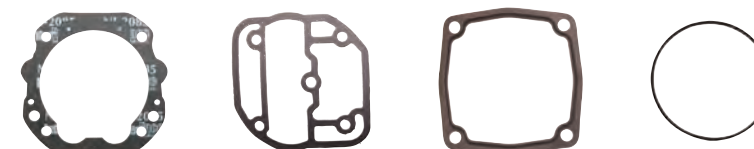

Repair Kit For Plate

dph-nr 1455368

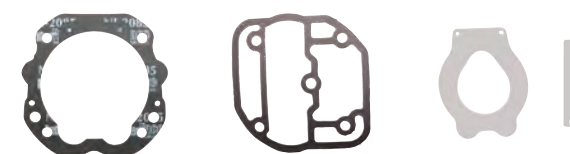



Dichtungspartner Hamburg

MERCEDES BENZ

COMPRESSOR REPAIR KIT AXOR MONOBLOCK

SINGLE CYLINDER AIR COMPRESSOR

dph-nr 1458809

MERCEDES BENZ

- 906 130 06 15
- 906 130 07 15
- 906 131 05 01
- 906 131 06 01
- 457 130 03 15
- 457 130 05 15

WABCO

- 911 153 000 0
- 911 153 001 0
- 411 151 000 0
- 411 153 000 0

VEHICLE APPLICATION

AXOR



Cylinderhead dph-nr 1455376



Valve Kit dph-nr 1455374

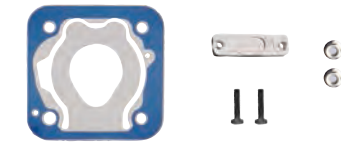

Repair Kit dph-nr 1455372



Gasket Kit dph-nr 1455373

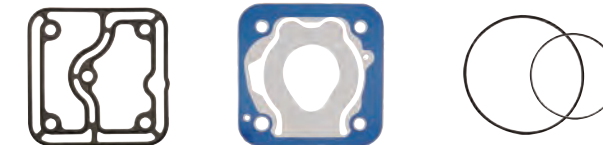

Complete Cylinderhead

dph-nr 1455375

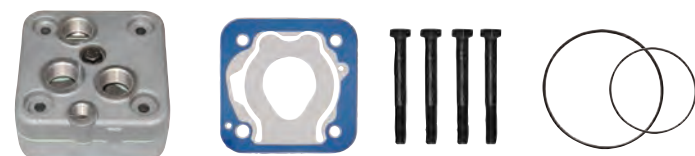

All manufacturers names, numbers, symbols and descriptions are used for reference purposes only.



All manufacturers names, numbers, symbols and descriptions are used for reference purposes only.



MERCEDES BENZ

MERCEDES BENZ

MERCEDES BENZ

- 906 130 13 15
- 906 130 14 15
- 906 130 30 15
- 906 130 29 15
- 906 130 43 15
- 906 130 44 51

WABCO

- 412 352 001 0
- 412 352 002 0
- 412 352 025 0
- 411 153 502 0

VEHICLE APPLICATION

- EVO
- BUS CITARO O 530N
- 4x2 BUS

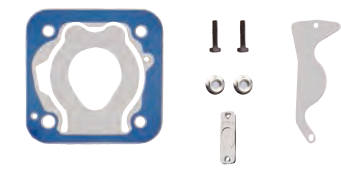
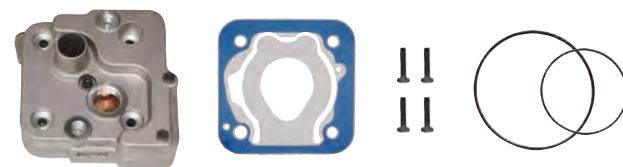

MERCEDES BENZ

457 130 36 15
457 130 37 15
457 130 48 15
457 130 49 15
457 130 55 15

WABCO

912 510 100 0
912 510 101 0
912 510 103 0
912 510 104 0
912 510 105 0

VEHICLE APPLICATION

AXOR
TRAVEGO
O500 UA BUS



Complete Cylinderhead

dph-nr 1455387

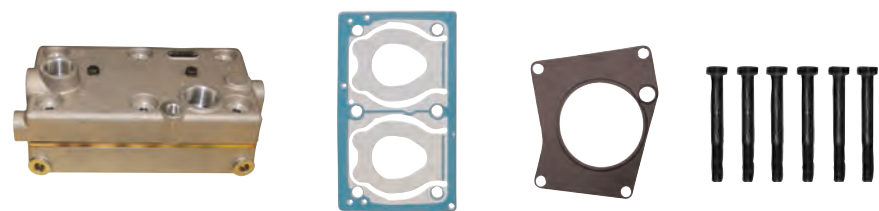

Valve Plate dph-nr 1455386



Cylinderhead dph-nr 1455388



Gasket dph-nr 1458050



Valve Kit dph-nr 1455385

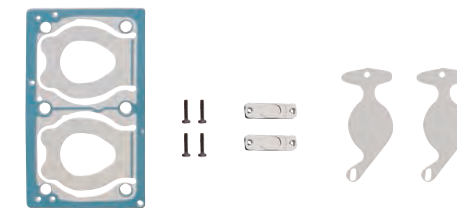

Repair Kit dph-nr 1455382

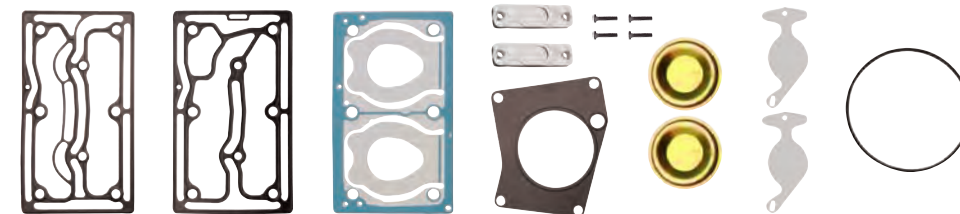

Head Repair Kit dph-nr 1455383

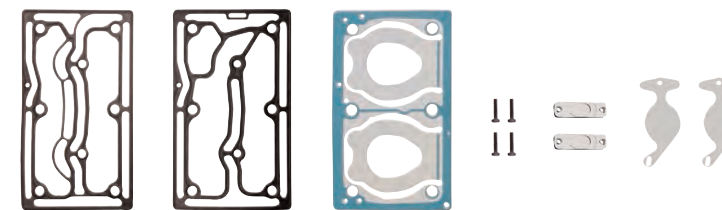

Gasket Kit dph-nr 1455384

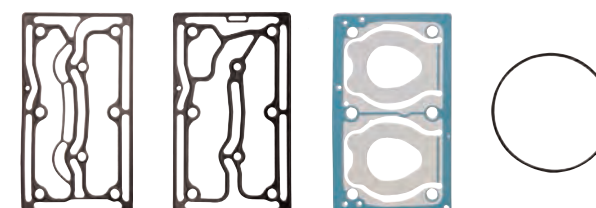

RENAULT

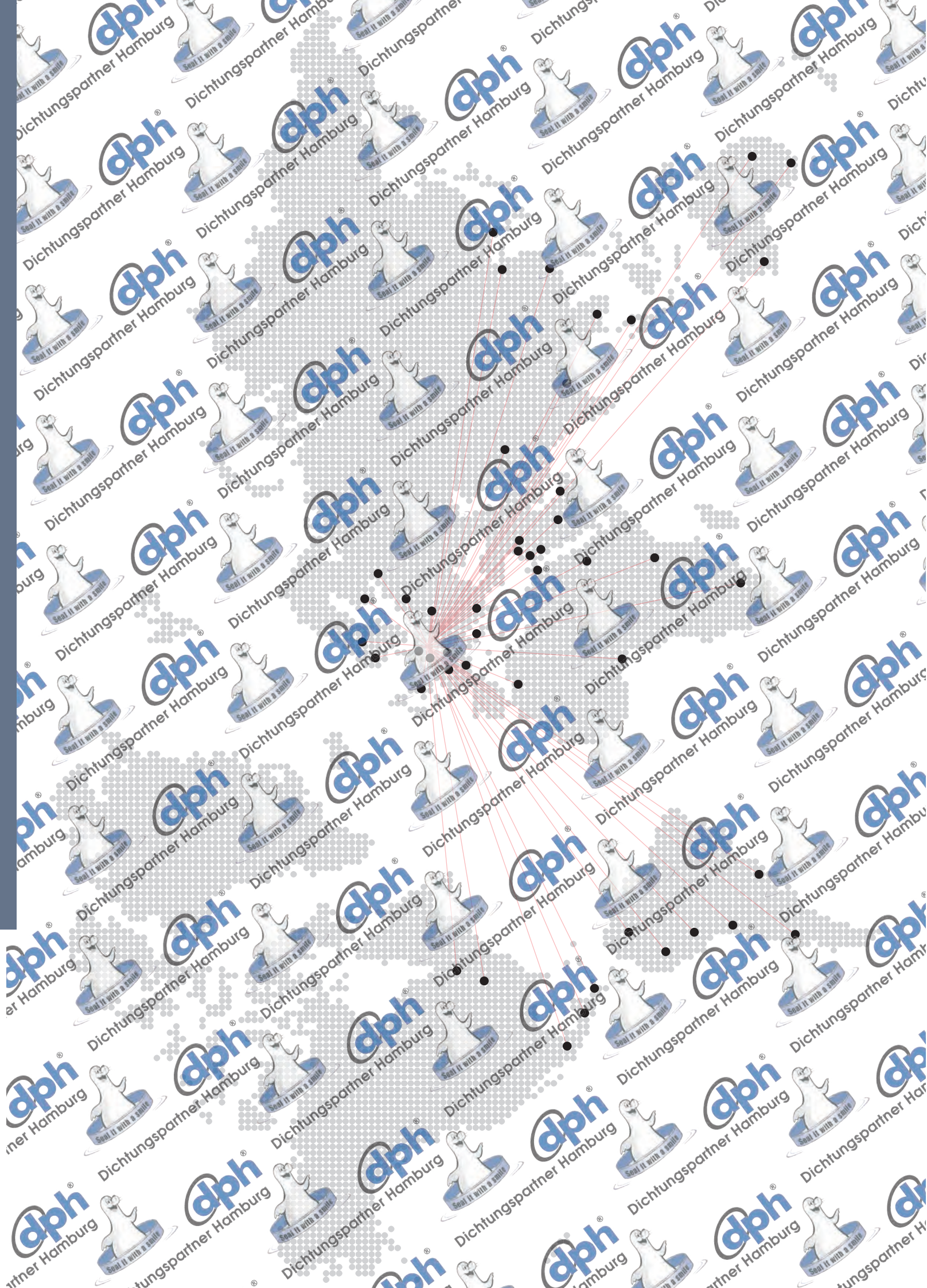

RENAULT

RENAULT

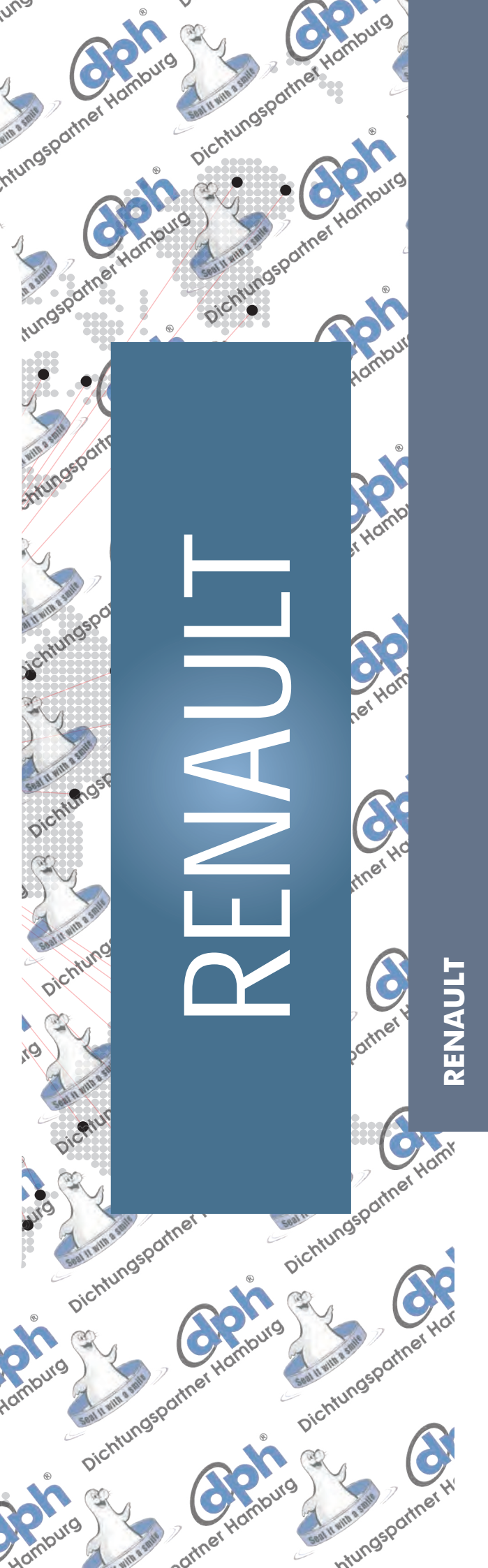



Dichtungspartner Hamburg

RENAULT

PREMIUM 500cc COMPRESSOR REPAIR KIT

TWIN CYLINDER AIR COMPRESSOR

dph-nr 1458812

RENAULT

- 5000694824
- 5010323293
- 5010339859
- 5000696056
- 5010295545
- 5010323738
- 5000693164
- 5000696058
- 5010258042
- 5010258169

KNORR-BREMSE

- LP4831
- LP4838
- LP4843
- LP4848
- LP4853
- LP4855

VEHICLE APPLICATION

- MAGNUM
- PREMIUM
- KERAX
- SISU



Full Repair Kit

dph-nr 1455390

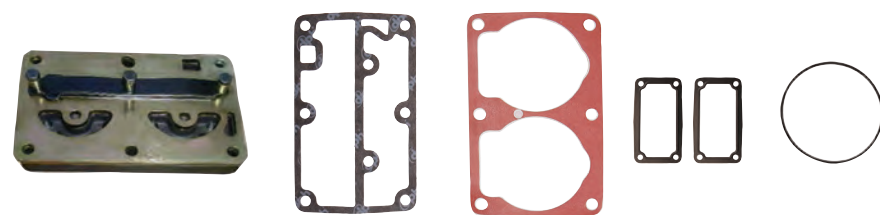

Valve Plate

dph-nr 1455391



Cylinderhead

dph-nr 1455392



Repair Kit

dph-nr 1258901

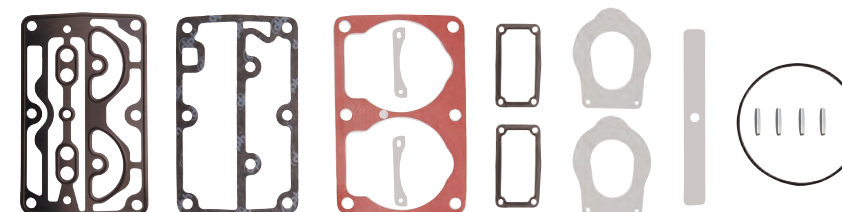

Gasket Kit

dph-nr 1258902

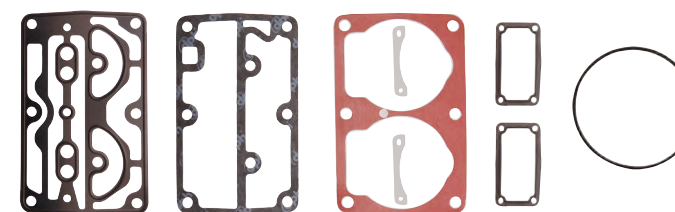

Head Repair Kit

dph-nr 1455389

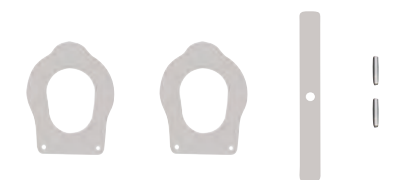

All manufacturers names, numbers, symbols and descriptions are used for reference purposes only.



All manufacturers names, numbers, symbols and descriptions are used for reference purposes only.



RENAULT

RENAULT



Dichtungspartner Hamburg

RENAULT

RENAULT-RVI COMPRESSOR REPAIR KIT

TWIN CYLINDER AIR COMPRESSOR

dph-nr 1458813

RENAULT

5010550086
5010437567

WABCO

412 442 000 0
412 442 001 0

VEHICLE
APPLICATION

PREMIUM TRACTEUR
KERAX
PREMIUM PR 4X2
MAGNUM E-TECH
400/440/480



Complete Cylinderhead

dph-nr 1455395



Valve Plate

dph-nr 1455394



Cylinderhead

dph-nr 1455396



Repair Kit

dph-nr 1258898

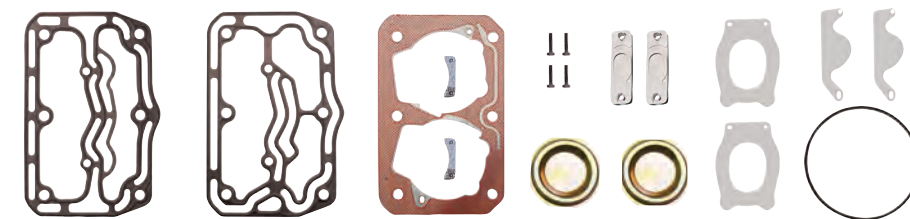

Gasket Kit

dph-nr 1258899

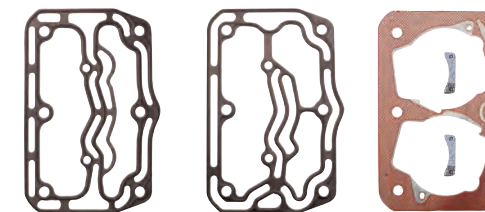

Valve Kit

dph-nr 1455393



All manufacturers names, numbers, symbols and descriptions are used for reference purposes only.



All manufacturers names, numbers, symbols and descriptions are used for reference purposes only.



RENAULT

7420713886

WABCO

412 704 009 0

VEHICLE
APPLICATION

MAGNUM DXI



Complete Cylinderhead

dph-nr 1455402

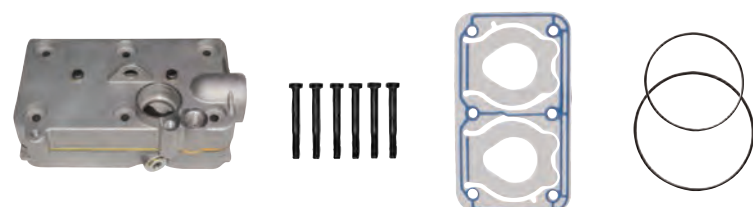

Valve Plate

dph-nr 1455401



Valve Kit

dph-nr 1455400

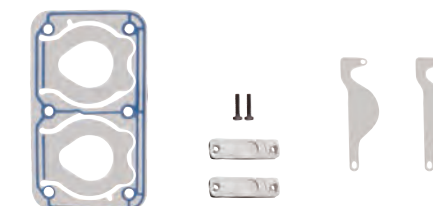

Repair Kit

dph-nr 1455397

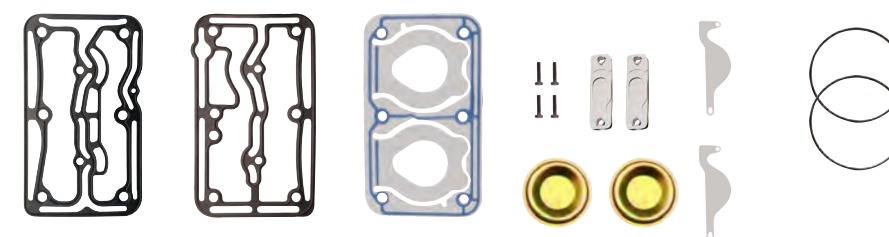

Head Repair Kit

dph-nr 1455398

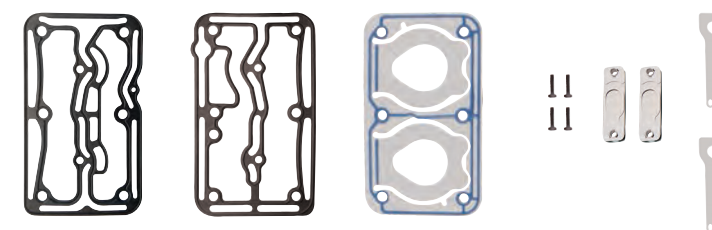

Gasket Kit

dph-nr 1455399

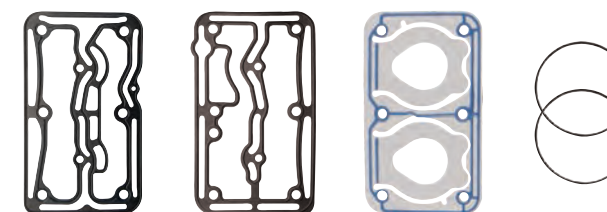

RENAULT

7421353473
7420774360

WABCO

911 512 001 0
912 512 006 0
912 512 007 0
912 514 004 0

VEHICLE APPLICATION

PREMIUM DXI13 ENGINE
KERAX DXI11 ENGINE
KERAX DXI13 ENGINE
MAGNUM DXI13 ENGINE
PREMIUM 380DXI
PREMIUM 430DXI
PREMIUM 440DXI
PREMIUM 460DXI

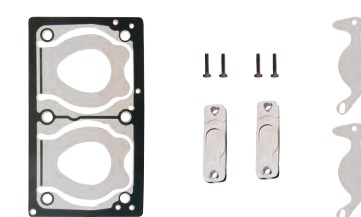
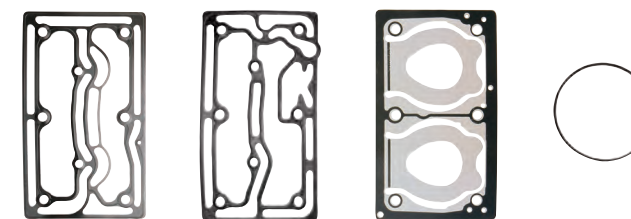
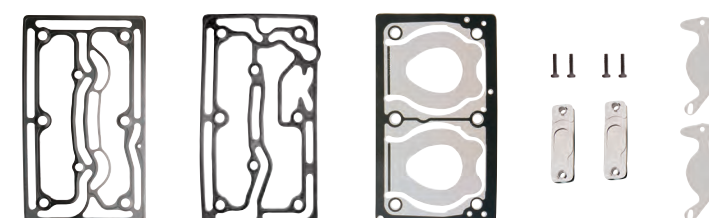
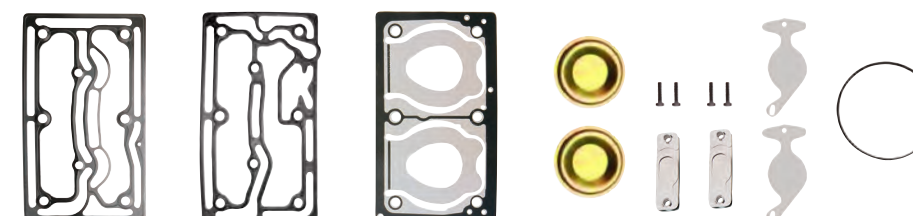
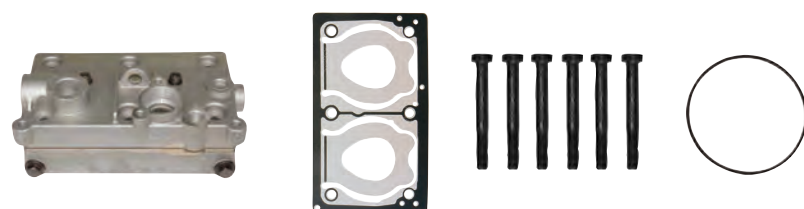

SINGLE CYLINDER AIR COMPRESSOR

RENAULT

5000694442
5000691934
5000790215
5000249628
5000684163

KNORR-BREMSE

LP3832
LP3833
LP3843
LP3852
LP3857
LP3860
LP3861
LP3862

VEHICLE APPLICATION

MIDLUM
C230
C280
C300
C340TI
CCH300

Gasket Kit

dph-nr 1455412



Repair Kit

dph-nr 1455411

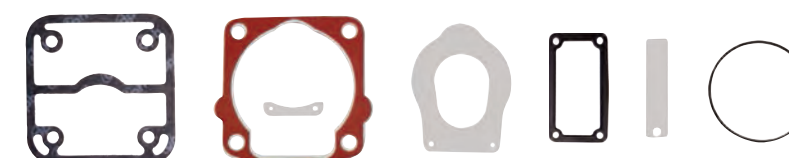

Valve Kit

dph-nr 1455413



Repair Kit

dph-nr 1455410

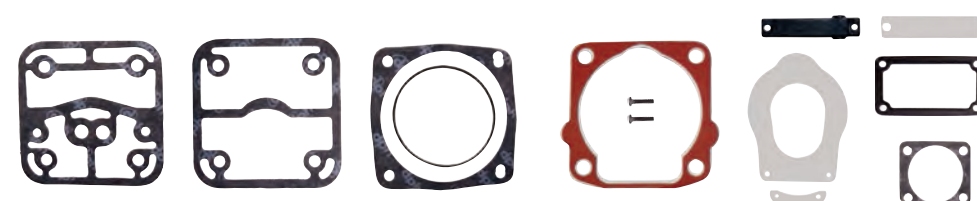



Dichtungspartner Hamburg

RENAULT

MIDLUM COMPRESSOR REPAIR KIT

TWIN CYLINDER AIR COMPRESSOR

dph-nr 1458817

RENAULT

5000684744

5000694727

KNORR-BREMSE

1013077000 - 1013391000

1013395000 - 1013397000

1013491000

1013078000 - 1013080000

1013081000 - 1013083000

1013084000 - 1013085000

1013099000 - 1013278000

1013281000 - 1013283000

1013284000 - 1013285000

1013378000 - 1013383000

1013387000 - 1013393000

1013398000

LP4818 - LP4832 - LP4940

LP4942 - LP4944

LP4939 - SEB01154

LP4941 - SEB01156

LP4943 - SEB01158

LP4945 - SEB01160

VEHICLE APPLICATION

G260 - G290

R365 - C230

C260 - C290

C280 - C300

R370 - R390

C340 - G230

R420 - R310

G270 - G220

R330 - R340

MANAGER



Gasket Kit

dph-nr 1455414



Reair Kit

dph-nr 1455415

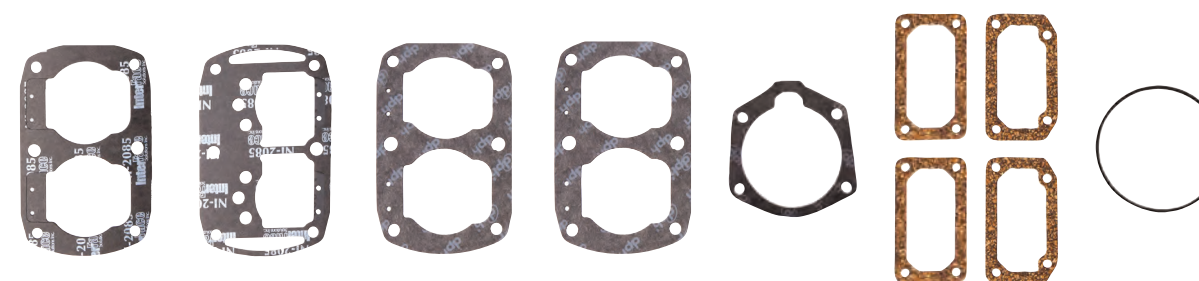

Gasket Kit

dph-nr 1455416



Valve Kit

dph-nr 1455417



Repair Kit

dph-nr 1258900

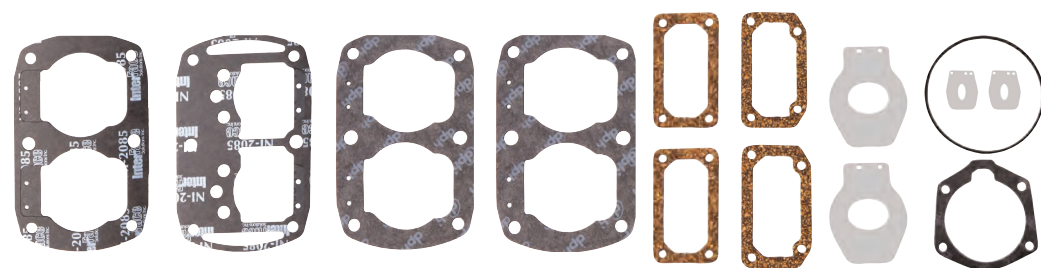

All manufacturers names, numbers, symbols and descriptions are used for reference purposes only.



All manufacturers names, numbers, symbols and descriptions are used for reference purposes only.



RENAULT

RENAULT



SCANIA





Dichtungspartner Hamburg

SCANIA

LP49.. KNORR - BREMSE COMPRESSOR REPAIR KIT

TWIN CYLINDER AIR COMPRESSOR

dph-nr 1458818

SCANIA

- 1349094
- 1513115
- 1380456
- 1796663
- 1380455
- 1380457

KNORR-BREMSE

- LK4941 - K016615
- LP4964
- LP4965
- LP4966
- LP4957
- LP4963

VEHICLE APPLICATION

- K-N BUS VEHICLES SERIES
- K-N BUS VEHICLES SERIES



Repair Kit

dph-nr 1258858

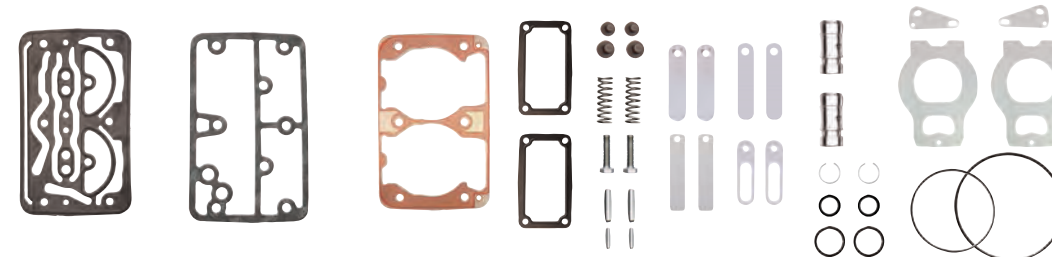

Repair Kit

dph-nr 1455418

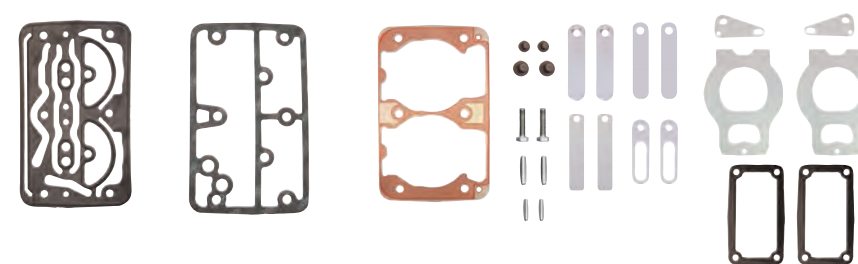

Gasket Kit

dph-nr 1258859

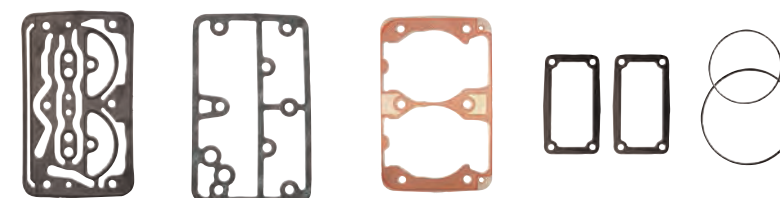

Valve Kit

dph-nr 1455419



Valve Kit

dph-nr 1455420



Cylinderhead

dph-nr 1455421



Valve Plate

dph-nr 1455422



Unloader Kit

dph-nr 1258860



All manufacturers names, numbers, symbols and descriptions are used for reference purposes only.



All manufacturers names, numbers, symbols and descriptions are used for reference purposes only.



SCANIA

SCANIA

SCANIA

1386866

KNORR-BREMSE

- LK3986
- LK3810
- LK3813
- LK3819
- LK3821
- LP3975
- LK3970

VEHICLE APPLICATION

4SERIES
HEAVY DUTY VEHICLES

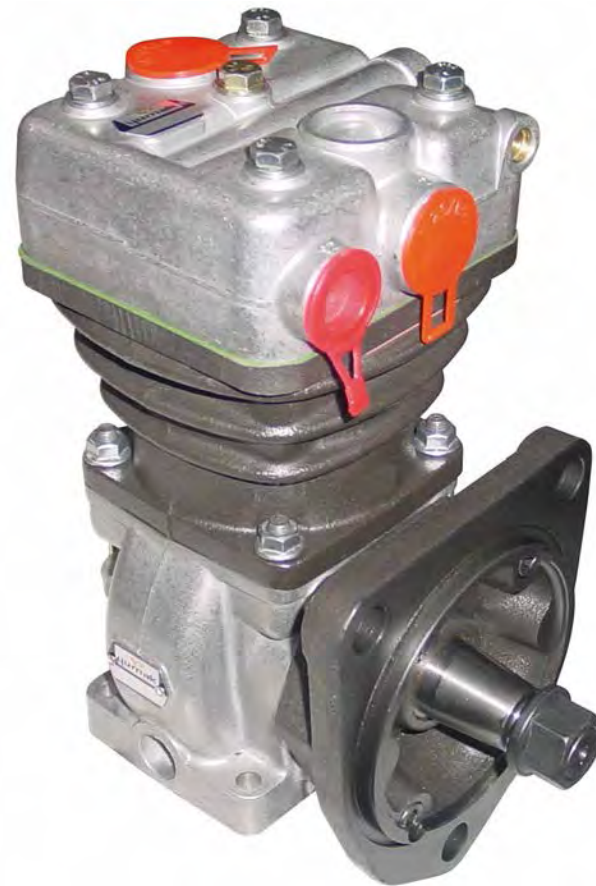

Valve Plate Kit

dph-nr 1455425

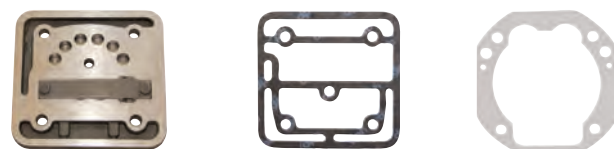

Valve Kit

dph-nr 1455426



Cylinderhead

dph-nr 1455427



Repair Kit

dph-nr 1258875

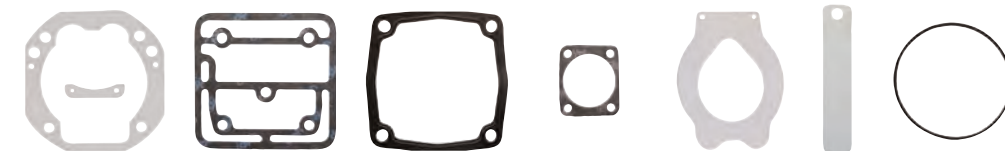

Gasket Kit

dph-nr 1455423

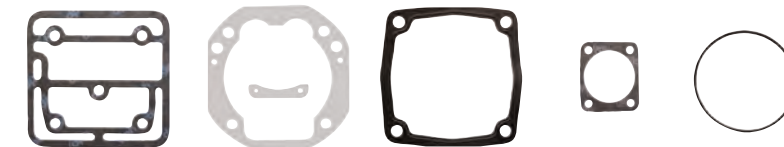

Valve Kit

dph-nr 1455424



SCANIA

571183
1303226
1303227
571184
1381951

KNORR-BREMSE

LP4814
LP4815
LP4844

VEHICLE APPLICATION

3 SERIES TRUCK & BUS
4 SERIES HEAVY DUTY
4 SERIES TRUCK & BUS



Cylinderhead

dph-nr 1455431



Valve Plate

dph-nr 1455430



Repair Kit

dph-nr 1455428

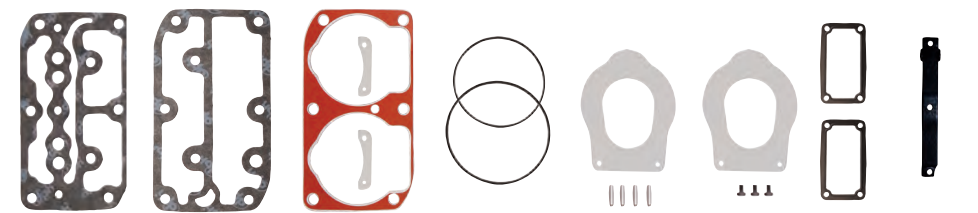

Repair Kit

dph-nr 1258869

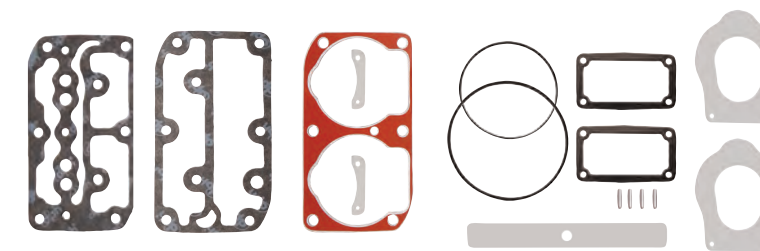

Gasket Kit

dph-nr 1258870

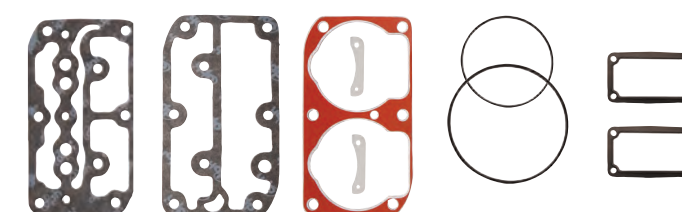

Valve Kit

dph-nr 1455429





Dichtungspartner Hamburg

SCANIA

TF-700 KZ996/2RM, BENDIX 15,5 COMPRESSOR REPAIR KIT

TWIN CYLINDER AIR COMPRESSOR

dph-nr 1458821

SCANIA

- 1327231
- 1348920
- 301525
- 1348919
- 1300366
- 394441
- 571185

KNORR-BREMSE

- 1188844
- 1186722
- KZ996/2RM
- KZ1228/1
- KZ396
- KZ433
- KZ456
- KZ625
- KZ641

VEHICLE APPLICATION

3 SERIES TRUCK & BUS



Cylinderhead dph-nr 1250235

Closed Version



Cylinderhead dph-nr 1455432

Open Version



Repair Kit

dph-nr 1258840

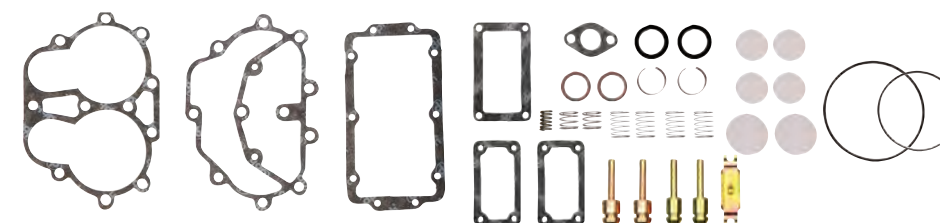

Gasket Kit

dph-nr 1258841

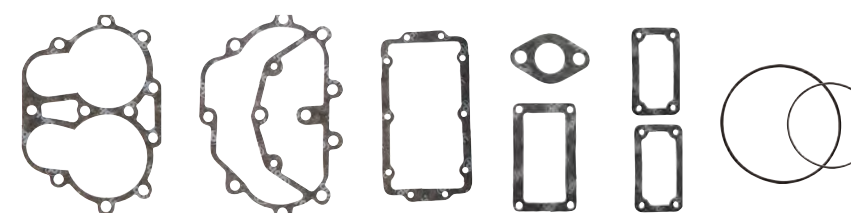

Valve Kit

dph-nr 1258842

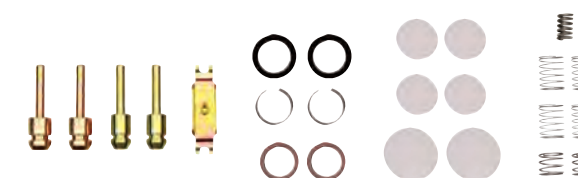

Valve Plate

dph-nr 1258847

11 HOLES



Valve Plate

dph-nr 1258855

10 HOLES



All manufacturers names, numbers, symbols and descriptions are used for reference purposes only.



All manufacturers names, numbers, symbols and descriptions are used for reference purposes only.



SCANIA

SCANIA



VOLVO



Dichtungspartner Hamburg

VOLVO

FH TWIN CYLINDER COMPRESSOR REPAIR KIT

TWIN CYLINDER AIR COMPRESSOR

dph-nr 1458822

VOLVO

- 20701801
- 20547525
- 20569224
- 20382347

WABCO

- 412 704 001 0
- 412 704 004 0
- 412 704 005 0
- 412 704 008 0

VEHICLE APPLICATION

- FH12
- FM12
- NH12



Complete Cylinderhead

dph-nr 1455438

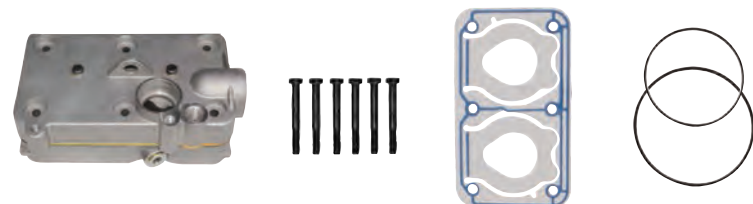

Valve Plate

dph-nr 1455437



Valve Kit

dph-nr 1455436

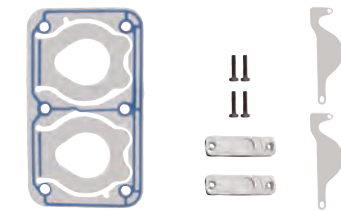

Repair Kit

dph-nr 1455433

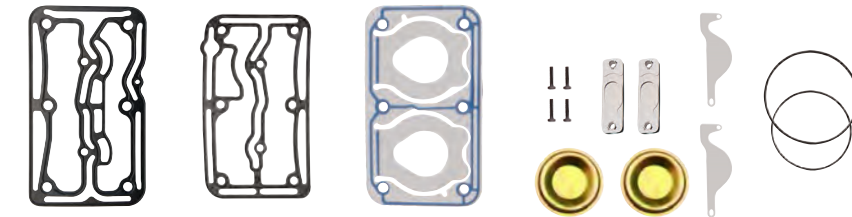

Head Repair Kit

dph-nr 1455434

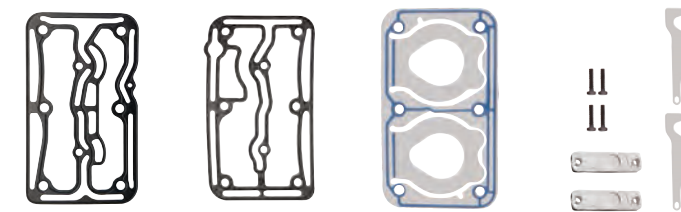

Gasket Kit

dph-nr 1455435

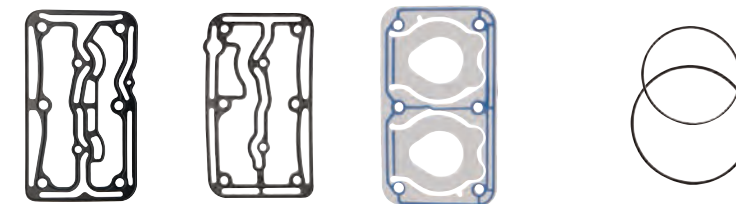

All manufacturers names, numbers, symbols and descriptions are used for reference purposes only.



All manufacturers names, numbers, symbols and descriptions are used for reference purposes only.





Dichtungspartner Hamburg

VOLVO

FH TWIN CYLINDER COMPRESSOR REPAIR KIT

TWIN CYLINDER AIR COMPRESSOR

dph-nr 1458823

VOLVO

- 20701801
- 20547525
- 20569224
- 20382347

WABCO

- 412 704 001 0
- 412 704 004 0
- 412 704 005 0
- 412 704 008 0

VEHICLE APPLICATION

- FH12
- FM12
- NH12



Complete Cylinderhead

dph-nr 1455443

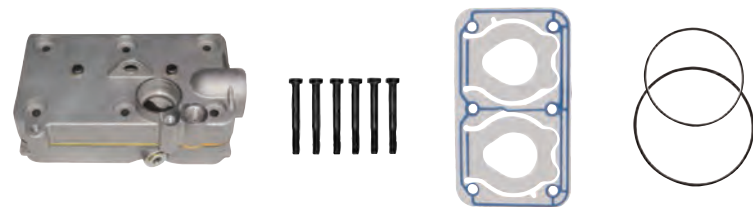

Valve Plate

dph-nr 1455442



Valve Kit

dph-nr 1455441

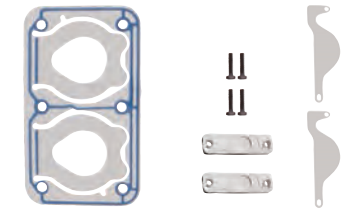

Repair Kit

dph-nr 1258913

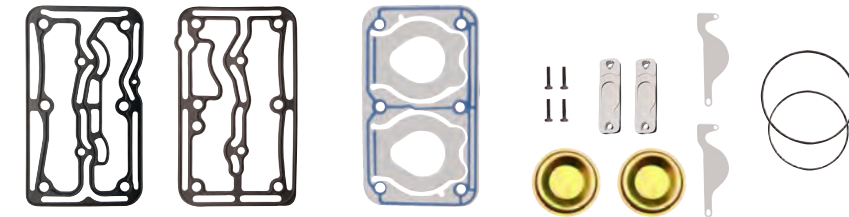

Head Repair Kit

dph-nr 1455439

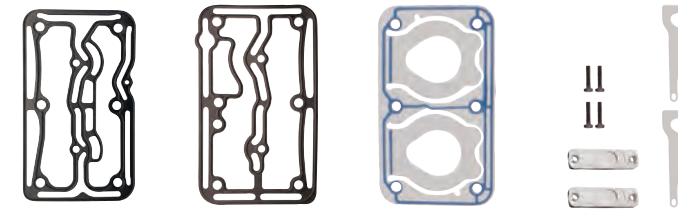

Gasket Kit

dph-nr 1455440

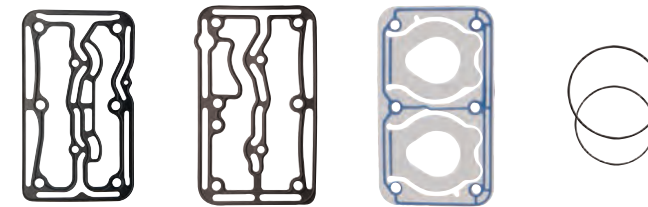

All manufacturers names, numbers, symbols and descriptions are used for reference purposes only.



All manufacturers names, numbers, symbols and descriptions are used for reference purposes only.



VOLVO

20382348
20382346

WABCO

412 352 005 0

VEHICLE APPLICATION

FH12
FM12
NH12
FM9



Cylinderhead

dph-nr 1455449



Valve Plate

dph-nr 1455448



Repair Kit

dph-nr 1455444



Head Repair Kit

dph-nr 1455445

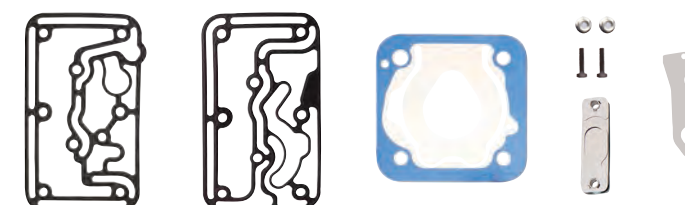

Gasket Kit

dph-nr 1455446

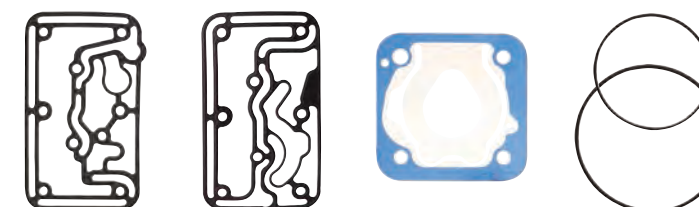

Valve Kit

dph-nr 1455447

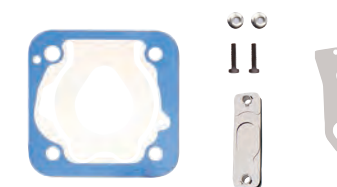



Dichtungspartner Hamburg

VOLVO

FH TWIN CYLINDER COMPRESSOR REPAIR KIT

TWIN CYLINDER AIR COMPRESSOR

dph-nr 1458796

VOLVO

20478166
20382346
20451727
20733972
20733974

WABCO

412 352 004 0
912 112 000 0
912 114 000 0
912 142 000 0

VEHICLE APPLICATION

FH12
FM12
NH12
FM9



Repair Kit

dph-nr 1455450



Head Repair Kit

dph-nr 1455451

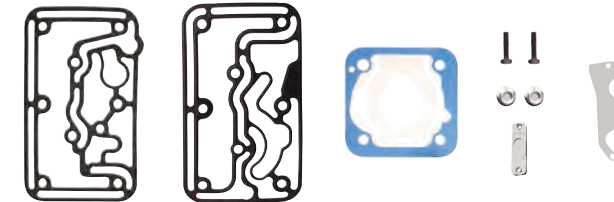

Gasket Kit

dph-nr 1455452

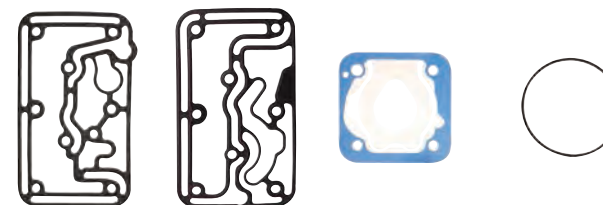

Valve Kit

dph-nr 1455453



Cylinderhead

dph-nr 1455455



Valve Plate

dph-nr 1455454



All manufacturers names, numbers, symbols and descriptions are used for reference purposes only.



All manufacturers names, numbers, symbols and descriptions are used for reference purposes only.





Dichtungspartner Hamburg

VOLVO

LP4930 / LP4974 KNORR - BREMSE COMPRESSOR REPAIR KIT

TWIN CYLINDER AIR COMPRESSOR

dph-nr 1458779

VOLVO

1628593
8112584
8113264
20429339

KNORR-BREMSE

LP4930
LP4974

VEHICLE APPLICATION

B10
B12
FH12
FH16
FM7
FM12



Cylinderhead

dph-nr 1455463



Valve Plate

dph-nr 1455462



Repair Kit

dph-nr 1455456

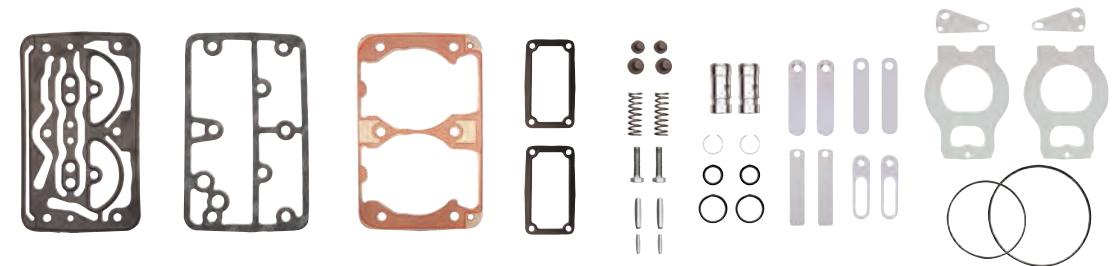

Repair Kit

dph-nr 1455457

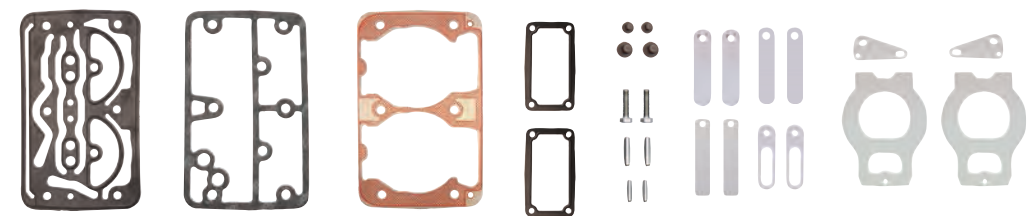

Gasket Kit

dph-nr 1455458

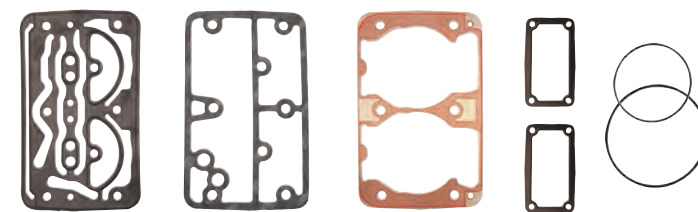

Valve Kit

dph-nr 1455459



Valve Kit

dph-nr 1455460



Unloader Kit

dph-nr 1455461



All manufacturers names, numbers, symbols and descriptions are used for reference purposes only.



All manufacturers names, numbers, symbols and descriptions are used for reference purposes only.





Dichtungspartner Hamburg

VOLVO

LP4825 & LP4829 KNORR COMPRESSOR REPAIR KIT

TWIN CYLINDER AIR COMPRESSOR

dph-nr 1458777

VOLVO

8150407
8112427

KNORR-BREMSE

LP4825
LP4829

VEHICLE
APPLICATION

F10
F12
FL10
F16
NL10
NL12
FM10
B10M
B58



Cylinderhead

dph-nr 1455469



Valve Plate

dph-nr 1455468



Repair Kit

dph-nr 1258862

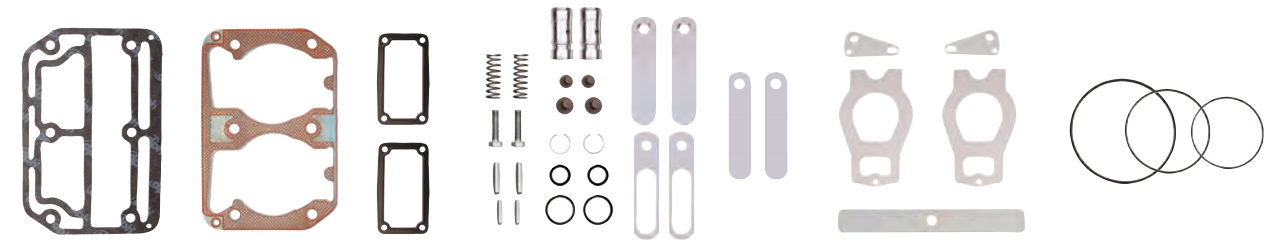

Repair Kit

dph-nr 1455464

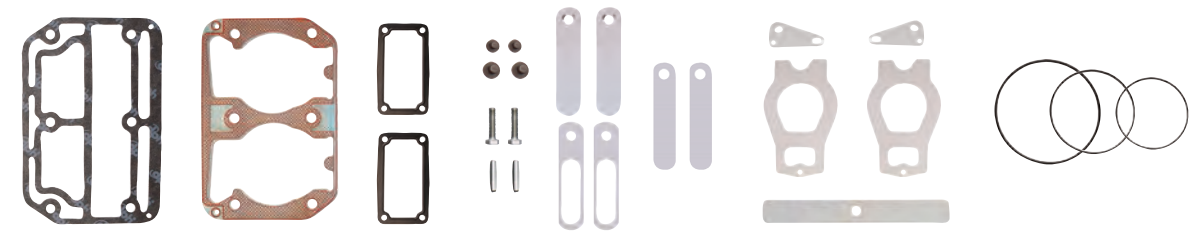

Gasket Kit

dph-nr 1258863

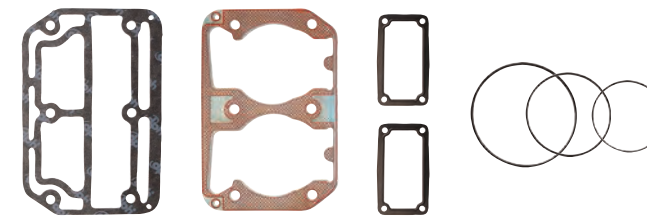

Valve Kit

dph-nr 1455465



Valve Kit

dph-nr 1455466



Unloader Kit

dph-nr 1455467



All manufacturers names, numbers, symbols and descriptions are used for reference purposes only.



All manufacturers names, numbers, symbols and descriptions are used for reference purposes only.





Dichtungspartner Hamburg

VOLVO

LK3930 SINGLE CYLINDER COMPRESSOR REPAIR KIT

SINGLE CYLINDER AIR COMPRESSOR

dph-nr 1458776

VOLVO

20429337
3987601
8113263
8112583
1628592
118065

KNORR-BREMSE

LK3930
LK3965
LK3982

VEHICLE APPLICATION

FM12
FM12



Repair Kit

dph-nr 1455470

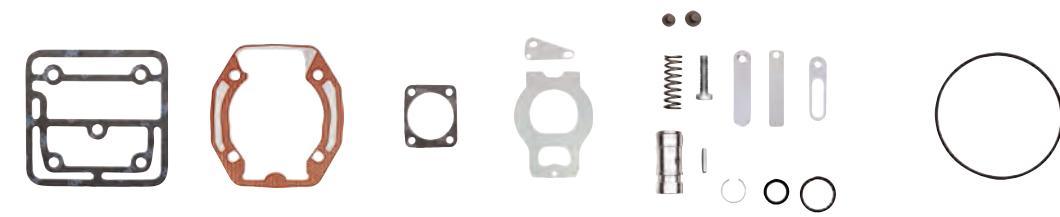

Repair Kit

dph-nr 1455471

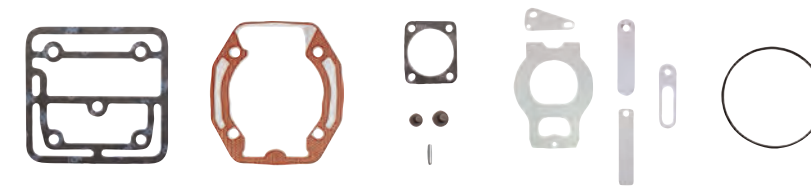

Gasket Kit

dph-nr 1455472



Valve Kit

dph-nr 1455474



Valve Kit

dph-nr 1455473



Cylinderhead

dph-nr 1455477



Valve Plate

dph-nr 1455476



Unloader Kit

dph-nr 1455475



All manufacturers names, numbers, symbols and descriptions are used for reference purposes only.



All manufacturers names, numbers, symbols and descriptions are used for reference purposes only.





Dichtungspartner Hamburg

VOLVO

LK3986 & LK3810/13/19/21 COMPRESSOR REPAIR KIT

SINGLE CYLINDER AIR COMPRESSOR

dph-nr 1458181

VOLVO

20429341

KNORR-BREMSE

- LK3986
- LK3810
- LK3813
- LK3819
- LK3821
- LP3975
- LK3970

VEHICLE APPLICATION

- FH12
- FL12

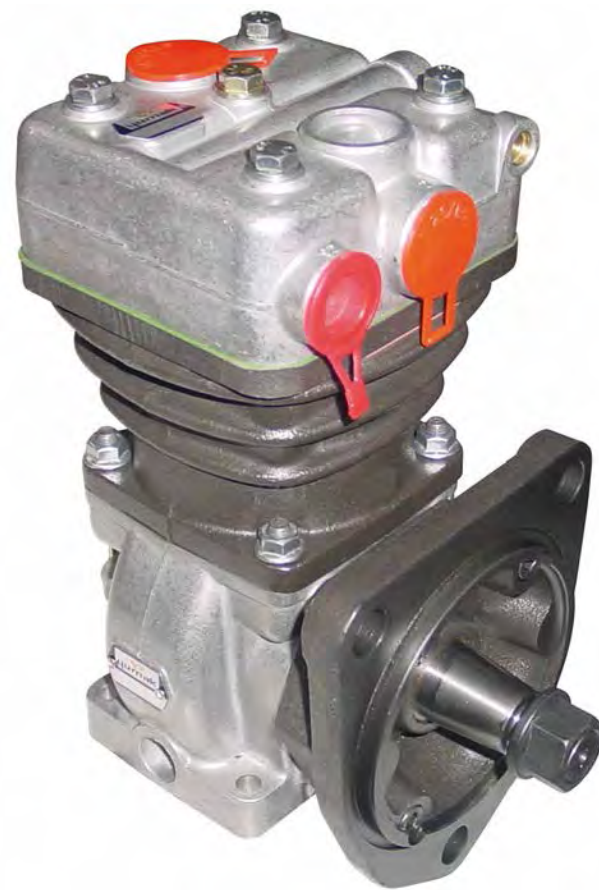

Valve Plate Kit

dph-nr 1455481

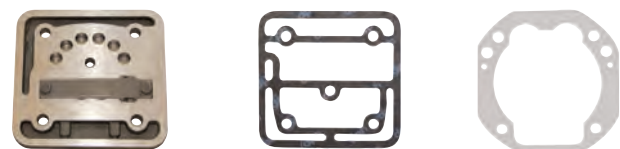

Cylinderhead

dph-nr 1455483



Valve Plate

dph-nr 1455482



Repair Kit

dph-nr 1455478

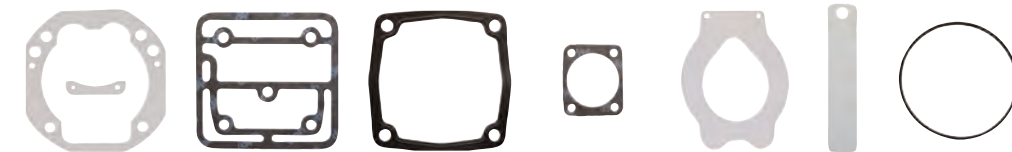

Gasket Kit

dph-nr 1455479

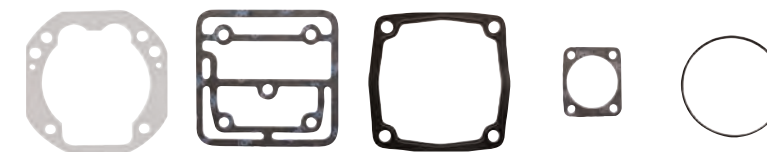

Valve Kit

dph-nr 1455480



All manufacturers names, numbers, symbols and descriptions are used for reference purposes only.



All manufacturers names, numbers, symbols and descriptions are used for reference purposes only.





Dichtungspartner Hamburg

VOLVO

LP49.. & LK49.. KNORR - BREMSE COMPRESSOR REPAIR KIT

TWIN CYLINDER AIR COMPRESSOR

dph-nr 1458920

VOLVO

8113405
3173001
85000066
2049343

KNORR-BREMSE

LK4920
LP4985
LP4988
LP4991
LP4992
LP4995

VEHICLE APPLICATION

FH
FH12
FH16
FM
FM7
FM12
B10



Cylinderhead dph-nr 1455489



Valve Plate dph-nr 1455488



Repair Kit dph-nr 1455484

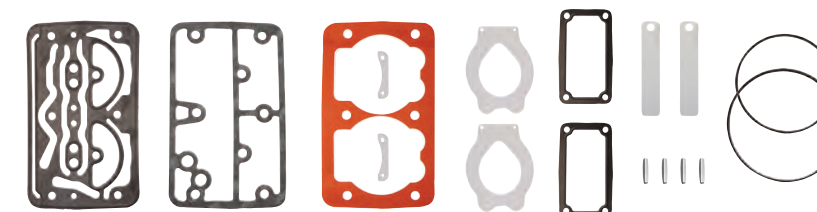

Gasket Kit dph-nr 1455485

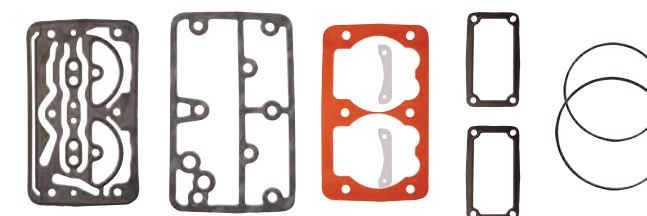

Valve Kit dph-nr 1455486



Valve Plate Kit dph-nr 1455487

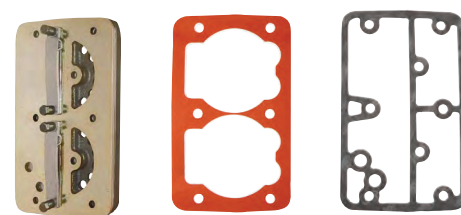

All manufacturers names, numbers, symbols and descriptions are used for reference purposes only.



All manufacturers names, numbers, symbols and descriptions are used for reference purposes only.





Dichtungspartner Hamburg

VOLVO

WABCO 704 cm³ TWIN CYLINDER COMPRESSOR REPAIR KIT

TWIN CYLINDER AIR COMPRESSOR

dph-nr 1458921

VOLVO

5003460
1626060
3037344
8112426

WABCO

911 505 150 0
911 505 151 0

VEHICLE APPLICATION

F10
F12
F16
FL10
FL7
NL12
FM10



Complete Cylinderhead

dph-nr 1455494



Repair Kit

dph-nr 1455490

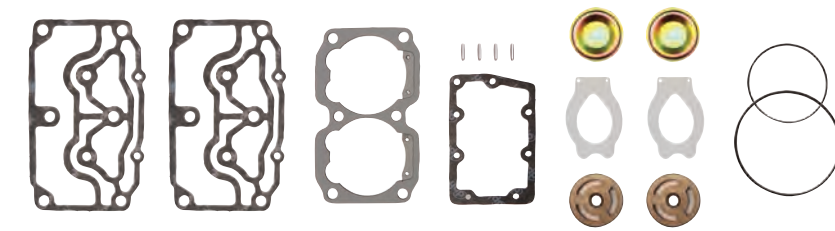

Repair Kit

dph-nr 1455491

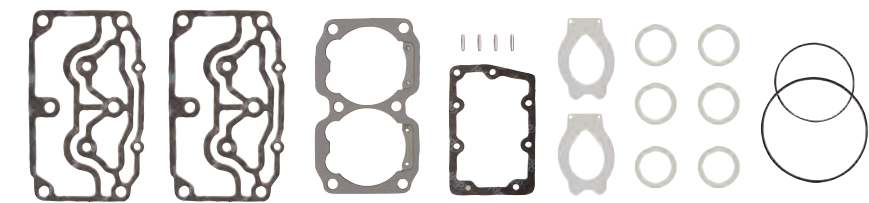

Gasket Kit

dph-nr 1455492

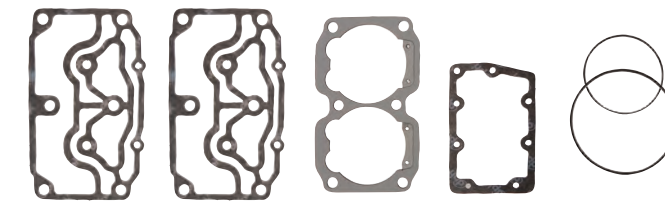

Valve Kit

dph-nr 1455493



All manufacturers names, numbers, symbols and descriptions are used for reference purposes only.



All manufacturers names, numbers, symbols and descriptions are used for reference purposes only.





Dichtungspartner Hamburg

VOLVO

LP4812 440CC COMPRESSOR REPAIR KIT

TWIN CYLINDER AIR COMPRESSOR

dph-nr 1458922

VOLVO

1599999
5003217

KNORR-BREMSE

LP4812

VEHICLE
APPLICATION

- B10M
- B6
- F16
- FL10
- FL7
- FS7
- FL6
- B10B
- B7R
- B12



Repair Kit

dph-nr 1455495

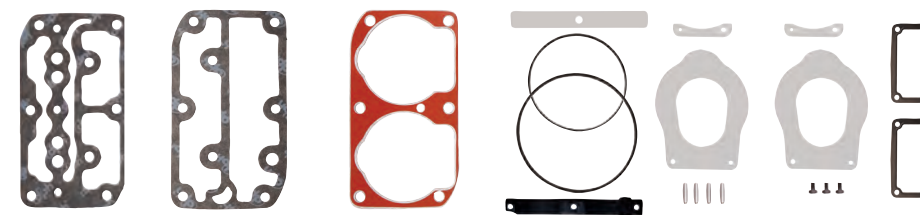

Repair Kit

dph-nr 1455496

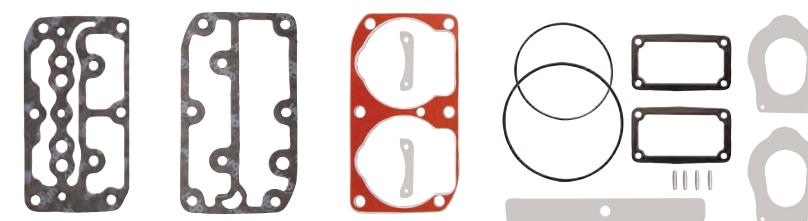

Gasket Kit

dph-nr 1258870

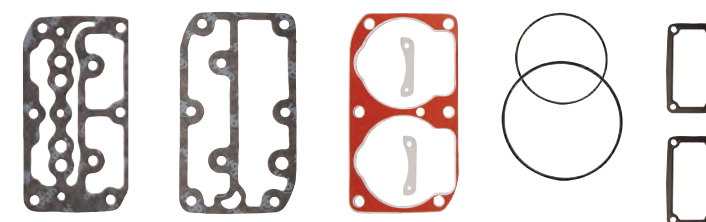

Valve Kit

dph-nr 1458053



Cylinderhead

dph-nr 1424694



Valve Plate

dph-nr 1458059



All manufacturers names, numbers, symbols and descriptions are used for reference purposes only.



All manufacturers names, numbers, symbols and descriptions are used for reference purposes only.





Dichtungspartner Hamburg

VOLVO

TF-700 KZ996/2RM, BENDIX 15,5 COMPRESSOR REPAIR KIT

TWIN CYLINDER AIR COMPRESSOR

dph-nr 1458923

VOLVO

- 1080437
- 8112780
- 1190395
- 1590264
- 1612335

KNORR-BREMSE

- 1188844
- 1186722
- KZ996/2RM
- KZ1228/1
- KZ396
- KZ433
- KZ456
- KZ625
- KZ641

VEHICLE APPLICATION

- | | |
|------|------|
| FL7 | NL10 |
| FL10 | NL12 |
| FL12 | B10M |
| F10 | B58 |
| F12 | |
| F16 | |



Cylinderhead dph-nr 1458057

Closed Version



Cylinderhead dph-nr 1250235

Open Version



Repair Kit

dph-nr 1455497

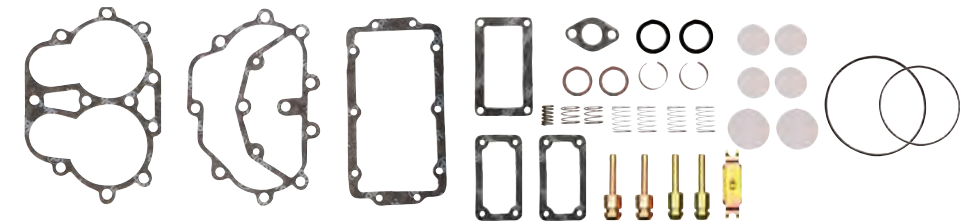

Gasket Kit

dph-nr 1258841

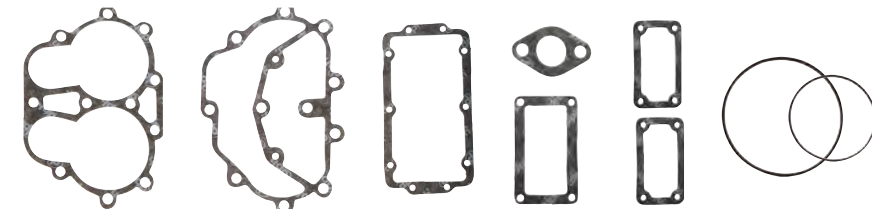

Valve Kit

dph-nr 1258842

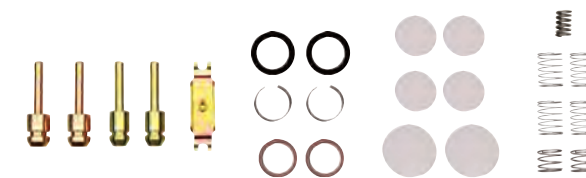

Valve Plate dph-nr 1258855

10 HOLES



Valve Plate dph-nr 1258847

11 HOLES



All manufacturers names, numbers, symbols and descriptions are used for reference purposes only.



All manufacturers names, numbers, symbols and descriptions are used for reference purposes only.



VOLVO

8129779

KNORR-BREMSE

LP4850
II35564

**VEHICLE
APPLICATION**

FL6
FL7
FL10



Complete Cylinderhead

dph-nr 1455107

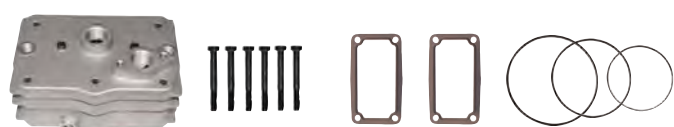

Valve Plate Kit dph-nr 1455105

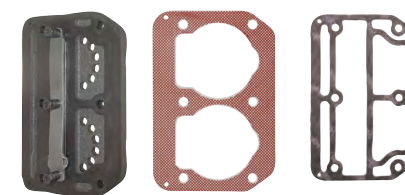

Valve Plate dph-nr 1455106



Repair Kit dph-nr 1455103

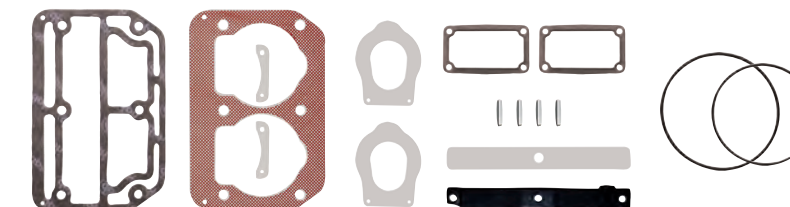

Repair Kit dph-nr 1258845

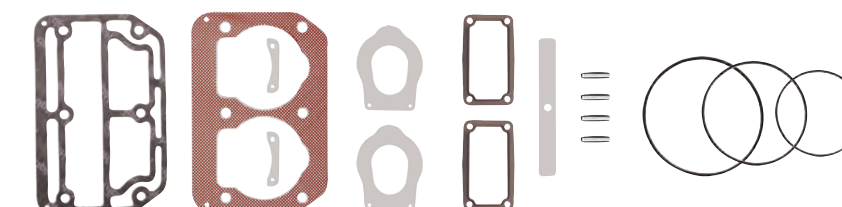

Gasket Kit dph-nr 1258846

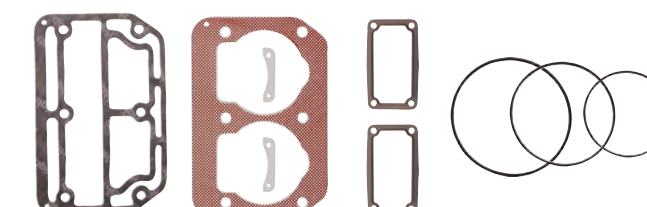

Valve Kit dph-nr 1455104



Air Compressor Repair Kit

PISTONS & RINGS

Air Compressor Repair Kit

PISTONS & RINGS

dph-no. OEM-no.

application

dph-no. OEM-no.

application

1458150 PISTON COMPLETE
85 mm STD
411 151 0000 - 411 153 0000
411 154 0000 - 411 553 0000
412 352 0030 - 412 352 0270
412 636 0000 - 412 704 0100
412 704 0150 - 884 016 6480
911 153 0000 - 911 153 0541
911 155 0500 - 911 155 0620
911 155 5140 - 911 155 5210
911 501 0500 - 911 505 1500
911 512 0010 - 911 553 0000
911 553 1050 - 912 112 0000
912 142 0000 - 912 510 0000
912 512 0010 - 912 518 2060



WABCO
911.501.624.2
911.501.625.2
DAF
1283781
MAN
81.54119.6040
M.BENZ
0001303417
0001305317
VOLVO
1698686

1458155 PISTON COMPLETE
100 mm STD
447 130 2815
OM501&OM502 (2 LINE VERTICAL)
OM501&OM502 (3 LINE HORIZONTAL)
ACTROS OM501&OM502
EURO1 BUS (2 LINE 100mm)
SETRA EVOBUS
OM401 - OM402 - OM421
OM422 - OM423 - OM440
OM441 - OM442 - OM443
OM447
MAN 19.464



MAN:51.54119.6001

1458151 PISTON COMPLETE
90 mm STD
411 142 5070
411 142 5660
411 142 6810
411 142 8800
411 142 9600
411 143 6800
411 143 6820
411 143 8610
411 143 8810



1458156 PISTON COMPLETE
88 mm STD
LK1802-14
LK3802-32
LK3904-86
LK4908-39
LP1828
LP3975
LP4957-97



KNORR
SEB22555
DAF
1361265
MAN
81.54119.0007
M.BENZ
0001302517
VOLVO
85101375/3095841/1698848

1458152 PISTON COMPLETE
90 mm STD
411 142 5070
411 142 5660
411 142 6810
411 142 8800
411 142 9600
411 143 6800
411 143 6820



1458157 PISTON COMPLETE
92 mm STD
K004489
K005801
K005977
K015948-65
LK3994
LK4928-30
LP3970-97



MAN
51.54119.6009

1458153 PISTON COMPLETE
90 mm STD
411 034 5010
411 034 5310
411 034 5410
411 034 5460
411 034 5470
411 034 5610



M.BENZ
000 130 1117

1458158 PISTON COMPLETE
80 mm STD
LK3833-3878



KNORR
SEB22517

1458154 PISTON COMPLETE
75 mm STD
411 140 0010
411 144 0000
411 145 0100
411 145 0510
411 145 5050
412 442 0000
911 145 0600
911 154 5000
911 504 0500
911 504 0600
911 504 5000
911 504 5060
911 506 0530



WABCO
411.141.623.2
DAF
513860
IVECO
8121570/9982648
MAN
81.54119.0004/81.54119.6039
M.BENZ
0001311607
RENAULT
5000816053

1458159 PISTON COMPLETE
75 mm STD
II15697
II18599
II34840-41
II35564
LP4812-50
SEB01782



KNORR
SEB22539/40
SCANIA
1315279-80
VOLVO
1697282

Air Compressor Repair Kit

PISTONS & RINGS

Air Compressor Repair Kit

PISTONS & RINGS

dph-no. OEM-no.

application

dph-no. OEM-no.

application

1458160 PISTON COMPLETE
75 mm STD
1186722
1188844
KZ1228-1
KZ396
KZ433
KZ456
KZ625
KZ641
KZ996/2RM



1458165 PISTON COMPLETE
75 mm STD
1186722
1188844
KZ1228-1
KZ396
KZ433
KZ456
KZ625
KZ641
KZ996/2RM



KNORR
SEB22551-552
RENAULT
5001830855/5001831273

1458161 PISTON COMPLETE
86 mm STD
1194487
LK4935-64
LP4861-65



1458162 PISTON COMPLETE
82 mm STD
ACX76-80
ACX82A-83A



1458163 PISTON COMPLETE
80 mm STD
ACX75ZF
ACX75ZFG
ACX75ZGG
ACX79CG
ACX79EG



IVECO
93161232

1458164 PISTON COMPLETE
80 mm STD
ACX69A
ACX69AS
ACX69CX
ACX69D
ACX69DX



Wheel Brake (Z-CAM)

dph-no. OEM-no.

application

Wheel Brake (Z-CAM)

dph-no. OEM-no.

application

1247038 1696450



Gasket
VOLVO

1258917 272904



Cover Repair Kit
VOLVO

1258921 1696453
272910



Cross Shaft
VOLVO

1258923 1698346
3097299
1696445



Pin Return Spring
VOLVO

1243032 309954



Dust Cover
VOLVO

1243068 3097092
1696444



Return Spring
VOLVO

1244062 1696446



Thrust Pin
VOLVO

1244063 1696924



Pinion, Left
VOLVO

1244064 1696925

Pinion, Right
VOLVO

1247036 3097099
8550978
272909



Repair Kit, Left
VOLVO

1258919 272906



Adjusting Device, Left
VOLVO

1254812 3097100
8550977
272908



Repair Kit, Right
VOLVO

Wheel Brake (Z-CAM)

dph-no. OEM-no.

application

Wheel Brake (Z-CAM)

dph-no. OEM-no.

application

1258920 272907



Adjusting Device, Right
VOLVO

1258924 1698967



Gaiter Adjusting Pin
VOLVO

1247037 276096



Repair Kit Adjusting Pin (old version)
VOLVO

1247392 272905



Gasket Kit
VOLVO

1258916 1626699



Gaiter Adjusting Pin
VOLVO

1266995 1697234
3095205



Sealing Ring (nbr)
VOLVO

1258922 276099



Repair Kit Adjusting Pin
VOLVO











1245384 3090964
276100



Repair Kit Adjusting Pin (new version)
VOLVO

Brake Caliper Repair Kit

Brake Caliper Repair Kit

dph-no.	OEM-no.	application	dph-no.	OEM-no.	application
1259859	K000944 K010604 SB 6000 SB 7000	 <p>Caliper Boots & Pistons Repair Kit</p> <p>74mm - Red Rubber 74mm - Black Rubber Bush 16x10</p>	1259864	SN 6000 SN 7000	 <p>Caliper Bridge Assembly (new model)</p>
1259860	K001300 K010603 SN 6000 SK 7000	 <p>Caliper Pistons Repair Kit</p> <p>69mm - Red Rubber 69mm - Black Rubber Bush 16x10</p>	1259865	SN 7000	 <p>Caliper Cover</p>
1259861	SB 6000 / SB 7000 SN 6000 / SN 7000	 <p>Caliper Calibration Bolt</p> <p>3 Thread</p>	1259866	II19712004 SB 6000 / SB 7000 SN 6000 / SN 7000	 <p>Caliper Brake Pad Retainer Repair Kit</p>
1259862	SB 6000 SB 7000	 <p>Caliper Bridge Assembly Set (old model)</p>	1259867	SN 7000	 <p>Caliper Lever</p> <p>Straight (Angle 0°) with Lever Bearing</p>
1259863	SB 6000 SB 7000	 <p>Caliper Bridge Assembly Set (new model)</p>	1259868	SN 7000	 <p>Caliper Lever</p> <p>Angle 12° with Lever Bearing</p>

Brake Caliper Repair Kit

dph-no. OEM-no.

application

1259869 SB 7000



Caliper Lever
Straight (Angle 0°)
with Lever Bearing

1259870 SB 7000



Caliper Lever
Angle 12°
with Lever Bearing

1259871 SN 7000



Caliper Roller Bearing
with Iron Bed
For 13510, 13511, 13512, 13513

1259872 SB 6000 / SB 7000
SN 6000 / SN 7000



Caliper Adjusting Mechanism

1259873 SB 6000 / SB 7000
SN 6000 / SN 7000



Caliper Adjusting Mechanism

Brake Caliper Repair Kit

dph-no. OEM-no.

application

1259874 SB 5000 / SB 6000
SB 7000
SN 6000 / SN 7000



Caliper Adjusting Wheel

1259875 SB 6000 / SB 7000
SN 6000 / SN 7000



Caliper Chain (29 links)

1259876 II9712004
SB 6000 / SB 7000
SN 6000 / SN 7000



Caliper Adjusting Nut

1259877 II328090062
SB 6000
SN 7000



Caliper Pin Set

Caliper Pin (Long) 36x145	x1
Caliper Pin (Short) 34x80	x1
Pin Bolt M16x1.5 - 150mm	x1
Pin Bolt M16x1.5 - 85mm	x1
Pin Bush (Long)	x1
Pin Rubber Bush (Black)	x1
Pin Bellow Rubber (Red)	x1
Pin Bellow Rubber (Black)	x1

1259878 SB 6000
SN 7000



Caliper Pin Set

Caliper Pin 34x80	x1
Pin Bolt M16x1.5 - 85mm	x1
Pin Rubber Bush (Black)	x1
Pin Bellow Rubber (Red)	x1
Pin Bellow Rubber (Black)	x1
Clamp	x1

Brake Caliper Repair Kit

dph-no. OEM-no.

application

1259879 SB 6000
SN 7000



Caliper Repair Kit
69mm - Red Rubber x2
69mm - Black Rubber x2
Bush 16x10 x2
Bearing Shaft x1
Spring Shaft x1
Bearing Shaft Body (New M.) x1
Calibration Bolt (3 Thread) x2
Calibration Shaft Chain x1
Spool Bearing x2 - Lever (Angle 0°) x1

1259880 SB 6000
SN 7000



Caliper Repair Kit
69mm - Red Rubber x2
69mm - Black Rubber x2
Bush 16x10 x2
Bearing Shaft x1
Spring Shaft x1
Bearing Shaft Body (New M.) x1
Calibration Bolt (3 Thread) x2
Calibration Shaft Chain x1
Spool Bearing x2 - Lever (Angle 12°) x1

1259881 SB 6000
SN 7000



Caliper Repair Kit
69mm - Red Rubber x2
69mm - Black Rubber x2
Bush 16x10 x2
Bearing Shaft x1
Spring Shaft x1
Bearing Shaft Body (06-07 M.) x1
Calibration Bolt (3 Thread) x2
Calibration Shaft Chain x1
Spool Bearing x2 - Lever (Angle 0°) x1

1259882 SB 6000
SN 7000



Caliper Repair Kit
69mm - Red Rubber x2
69mm - Black Rubber x2
Bush 16x10 x2
Bearing Shaft x1
Spring Shaft x1
Bearing Shaft Body (06-07 M.) x1
Calibration Bolt (3 Thread) x2
Calibration Shaft Chain x1
Spool Bearing x2 - Lever (Angle 12°) x1

1259883 SB 6000
SN 7000



Caliper Repair Kit
74mm - Red Rubber x2
74mm - Black Rubber x2
Bush 16x10 x2
Bearing Shaft x1
Spring Shaft x1
Bearing Shaft Body (Old M.) x1
Calibration Bolt (3 Thread) x2
Calibration Shaft Chain x1
Spool Bearing x2 - Lever (Angle 0°) x1

Brake Caliper Repair Kit

dph-no. OEM-no.

application

1259884 SB 6000
SB 7000



Caliper Repair Kit
74mm - Red Rubber x2
74mm - Black Rubber x2
Bush 16x10 x2
Bearing Shaft x1
Spring Shaft x1
Bearing Shaft Body (Old M.) x1
Calibration Bolt (3 Thread) x2
Calibration Shaft Chain x1
Spool Bearing x2 - Lever (Angle 12°) x1

1259885 SB 6000 / SB 7000



Pin Bush 36x40x20

1259886 II368470064
SB 6000 / SB 7000



Caliper Repair Kit
Caliper Pin 34x80 x1
Pin Bolt M16x1.5 - 85mm x1
Pin Rubber Bush (Black) x1

1259887 SN 6000 / SN 7000



Caliper Repair Kit
Caliper Pin 34x80 x1
Pin Rubber Bush (Black) x1

1259888 SN 6000
SN 7000



Pin Rubber Bush (long)

Brake Caliper Repair Kit

Brake Caliper Repair Kit

dph-no.	OEM-no.	application	dph-no.	OEM-no.	application
1259889	K001532 SN 6000 SN 7000	 <ul style="list-style-type: none"> Caliper Pin Set Caliper Pin (Long) 36x114 x1 Caliper Pin (Short) 32x80 x1 Pin Bolt M16x1.5 - 85mm x1 Pin Bolt M16x1.5 - 80mm x1 Pin Bush (Long) x1 Pin Dust Cover (with O-ring) x1 Pin Bellow Rubber (Red) x1 Pin Bolt Ring x1 Rubber Bush (Long) x1 	1259894	SN 6000 / SN 70	 <ul style="list-style-type: none"> Pin Rubber Bush (short)
1259890	K000472 SN 6000 SN 7000	 <ul style="list-style-type: none"> Caliper Pin Set Caliper Pin (Long) 36x114 x1 Caliper Pin (Short) 32x80 x1 Pin Bolt M16x1.5 - 85mm x1 Pin Bolt M16x1.5 - 80mm x1 Pin Bush (Long) x1 Pin Cap x1 Pin Bellow Rubber (Red) x1 Pin Bolt Ring x1 Rubber Bush (Long) x1 	1259895	K000687 SB 6000 SN 7000	 <ul style="list-style-type: none"> Caliper Repair Kit Caliper Pin (Long) 36x145 x1 Caliper Pin (Short) 32x80 x1 Pin Bolt M16x1.5 - 150mm x1 Pin Bolt M16x1.5 - 80mm x1 Pin Bush (Long) x1 Pin Bellow Rubber (Red) x1 Pin Bellow Rubber (Black) x1 Clamp x1 Pin Cap x1 - Rubber Bush (Short) x1
1259891	K000696 SN 6000 SN 7000	 <ul style="list-style-type: none"> Caliper Repair Kit Caliper Pin (Long) 36x114 x1 Pin Bolt M16x1.5 - 85mm x1 Pin Bush (Long) x1 Pin Dust Cover (with O-ring) x1 Pin Bellow Rubber (Red) x1 	1259896	SB 6000 SN 7000	 <ul style="list-style-type: none"> Caliper Repair Kit Caliper Pin (Long) 36x145 x1 Caliper Pin (Short) 34x80 x1 Pin Bolt M16x1.5 - 140mm x1 Pin Bolt M16x1.5 - 85mm x1 Pin Bush (Long) x1 Pin Rubber Bush (Black) x2 Pin Bellow Rubber (Red) x1 Pin Bellow Rubber (Black) x1 Clamp x1
1259892	SB 6000 / SB 7000 SN 6000 / SN 7000	 <ul style="list-style-type: none"> Pin Cap x6 	1259897	SB 6000 SN 7000	 <ul style="list-style-type: none"> Caliper Pin Set Caliper Pin (Long) 36x135 x1 Caliper Pin (Short) 34x80 x1 Pin Bush (Long) x1 Pin Rubber Bush (Black) x1 Pin Bellow Rubber (Red) x1 Pin Bellow Rubber (Black) x1 Clamp x1
1259893	SN 6000 SN 7000	 <ul style="list-style-type: none"> Caliper Repair Kit Caliper Pin (Long) 36x114 x1 Caliper Pin (Short) 32x80 x1 Pin Bolt M16x1.5 - 85mm x1 Pin Bolt M16x1.5 - 80mm x1 Rubber Bush (Long) x1 	1259898	K001301 SB 6000 / SB 70 SN 6000 / SN 70	 <ul style="list-style-type: none"> Caliper Repair Kit Pin Bellow Rubber (Black) x6 Clamp x6 Pin Dust Cover (with O-ring) x6

Brake Caliper Repair Kit

Brake Caliper Repair Kit

dph-no. OEM-no.

application

dph-no. OEM-no.

application

1259899 SB 5000
SN 5000

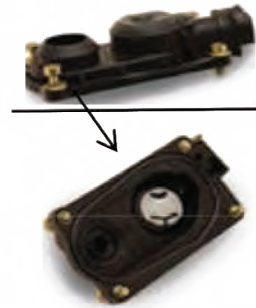

Caliper Plastic Cover

1259904 SB 5000
SN 5000



Caliper Cover

1259900 K001929
SB 5000
SN 5000



Caliper Boots & Pistons Repair Kit

Red Rubber x1
Black Rubber x1
Bush 16x10 x1

1259905 SB 5000
SN 5000



Caliper Lever

1259901 SB 5000
SN 5000



Caliper Repair Kit

Caliper Pin (Long) 30x99 x1
Caliper Pin (Short) 30x72 x1
Pin Bolt M16x1.5 - 105mm x1
Pin Bolt M16x1.5 - 75mm x1
Pin Bush (Long) x1
Pin Bush (Short) x1
Pin Bellow Rubber (Red) x2
Pin Plastic (Black) x2

1259906 SB 5000
SN 5000

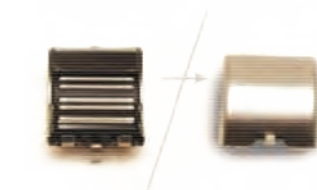

Caliper Roller Bearing

1259902 SB 5000
SN 5000



Caliper Shaft Housing Kit

1259907 SB 5000
SN 5000



Caliper Adjusting Mechanism

1259903 SB 5000
SN 5000



Caliper Calibration Bolt

1259908 SB 5000
SN 5000



Caliper Adjusting Pinion Gear

Brake Caliper Repair Kit

Brake Caliper Repair Kit

dph-no.	OEM-no.	application	dph-no.	OEM-no.	application
1259909	SB 5000 SN 5000	Caliper Chain (14 links)	1259914	SB 6000 / 7000 SN 6000 / 7000	Caliper Spring Adjusting Mechanism
1259910	SB 5000 / 6000 / 7000	Caliper Pin Rubber Bush (black)	1259915	SB 6000 / 7000 SN 6000 / 7000	Caliper Plastic Cover (2 lines)
1259911	SB 5000 / 6000 / 7000 SN 6000 / 7000	Caliper Cap	1259917	SB 6000 / 7000 SN 6000 / 7000	Caliper Plastic Cover (3 lines)
1259912	SB 5000 / 6000 / 7000 SN 6000 / 7000	Pin Bellow (red)	1259918	K003902	Caliper Repair Kit Plastic Cover- 35mm x10 Adjusting Nut x10
1259913	SB 5000 / 6000 / 7000 SN 6000 / 7000	Caliper Bronze Bush (long)	1259919	K000029	Caliper Repair Kit Plastic Cover- 38mm x10 Adjusting Nut x10



All manufacturers names, numbers, symbols and descriptions are used for reference purposes only.



All manufacturers names, numbers, symbols and descriptions are used for reference purposes only.



Brake Caliper Repair Kit

dph-no. OEM-no.

application

1259920 17.5"



Caliper Adjusting Set with Pin (short) x1
 Brake Caliper Calib. Shaft x1
 Caliper Pin (Long) 30x88 x1
 Caliper Pin (Short) 30x75 x1
 Pin Bolt M16x1.5 - 90mm x1
 Pin Bolt M16x1.5 - 70mm x1
 Caliper Rubber (Red) x1
 Caliper Pin Rubber (Green) x2
 Caliper Pin Bush 34x30x20 x4
 Pin Cap x2

1259921 17.5"



Caliper Calibration Shaft with Spring

1259985 17.5" / 19.5"



Caliper Washer Set

1259923 17.5"



Caliper Pin and Dust Rubber Set

Caliper Pin (Long) 30x88 x1
 Caliper Pin (Short) 30x75 x1
 Pin Bolt M16x1.5 - 90mm x1
 Pin Bolt M16x1.5 - 70mm x1
 Caliper Rubber (Red) x1
 Caliper Pin Rubber (Green) x2
 Caliper Pin Bush 34x30x20 x4
 Pin Cap x2

1259924 17.5"



Caliper Pin and Dust Rubber Set

Caliper Rubber (Red) x1
 Caliper Pin Rubber (Green) x2
 Caliper Pin Bush 34x30x20 x4
 Pin Cap x2

Brake Caliper Repair Kit

dph-no. OEM-no.

application

1259925 12999704
17.5"



Caliper Pin and Dust Rubber Set
 Pin Bolt M16x1.5 - 90mm x1
 Pin Bolt M16x1.5 - 70mm x1
 Caliper Rubber (Red) x1
 Caliper Pin Rubber (Green) x1
 Caliper Pin Bush 34x30x20 x1
 Pin Cap x1

1259926 17.5"



Caliper Bellow Repair Kit

Caliper Rubber (Red) x1
 Caliper Pin Rubber (Green) x2

1259928 17.5"



Caliper Calibration Bolt with Pin

1259929 17.5"



Caliper Brake Lining Plate with Groove, F

1259930 17.5"



Caliper Brake Lining Plate with Groove, L

Brake Caliper Repair Kit

Brake Caliper Repair Kit

dph-no. OEM-no.

application

dph-no. OEM-no.

application

1259931 17.5"



Caliper Adjusting Bolt with Slotted To

1259937 17.5" / 19.5"



Caliper Washer Set

1259932 17.5"



Caliper Brake Lining Plate with Pin, Ri

1259939 19.5"



Caliper Dust Rubber and Pin Set
 Caliper Pin (Long) 38x119 x1
 Caliper Pin (Short) 38x76 x1
 Pin Bolt M16x1.5 - 120mm x1
 Pin Bolt M16x1.5 - 80mm x1
 Caliper Pin Bush 42x38x30 x3
 Caliper Pin Rubber (Big) x1
 Caliper Pin Rubber (Small) x2
 Pin Cap (Short) x1
 Pin Cap (Long) x1 - Aluminium Washer:

1259933 17.5"



Caliper Brake Lining Plate with Pin, Le

1259940 19.5"



Caliper Guides and Seals Repair Kit

Caliper Pin Rubber (Big) x1
 Caliper Pin Rubber (Small) x2
 Aluminium Washer x2

1259935 19.5"



Caliper Adjusting Set with Pin (long) x1
 Brake Caliper Calib. Shaft x1
 Caliper Pin (Long) 38x119 x1
 Caliper Pin (Short) 38x76 x1
 Pin Bolt M16x1.5 - 120mm x1
 Pin Bolt M16x1.5 - 80mm x1
 Caliper Pin Bush 42x38x30 x3
 Caliper Pin Rubber (Big) x1
 Caliper Pin Rubber (Small) x2
 Pin Cap (Short) x1
 Pin Cap (Long) x1 - Aluminium Washer x2

1259941 19.5"



Caliper Adjusting Mechanism Bolt with F

1259936 19.5"



Caliper Adjusting Mechanism

1259942 19.5"



Caliper Lining Plate with Groove, Right

Brake Caliper Repair Kit

Brake Caliper Repair Kit

dph-no. OEM-no.

application

dph-no. OEM-no.

application

1259943 19.5"



Caliper Lining Plate with Groove, Left

1259950 LRG532



Caliper Repair Kit Full, Front Left
MERCEDES O403 / O404

Shaft L / Shaft Bearing Bed L / Caliper Gear (Big) L / Ball Bearing / Shaft Roller Bearing / Waved Washer / Spring (Big) L / Shaft Bush / Shaft Protective Plastic / Top Cover / Plastic Cover / Brake Adjuster Calib. Bolt / Brake Adjuster Gear (Small) / Spring (Small) L / Brake Ad.Cal. Bolt Rubber

1259944 17.5" / 19.5"



Caliper Roller Bearing Set

1259951 LRG533



Caliper Spline Shaft, Front Right
MERCEDES O403 / O404

26 Teeth

1259946 17.5" / 19.5" / 22.5 "



Caliper Gasket

1259952 LRG533



Caliper Spline Shaft, Front Left
MERCEDES O403 / O404

26 Teeth

1259947 17.5" / 19.5" / 22.5 "



Caliper Tappet Repair Kit

1259953 LRG533



Caliper Repair Kit Full, Rear Right
MERCEDES O403 / O404

Shaft R / Shaft Bearing Bed R / Caliper Gear (Big) R / Ball Bearing / Shaft Roller Bearing / Waved Washer / Spring (Big) R / Shaft Bush / Shaft Protective Plastic / Top Cover / Plastic Cover / Brake Adjuster Calib. Bolt / Brake Adjuster Gear (Small) / Spring (Small) R / Brake Ad.Cal. Bolt Rubber

1259948 LRG533



Caliper Repair Kit Full, Front Right
MERCEDES O403 / O404

1259954 LRG532



Caliper Repair Kit Full, Rear Left
MERCEDES O403 / O404

Shaft R / Shaft Bearing Bed R / Calipe Ball Bearing / Shaft Roller Bearing / V Spring (Big) R / Shaft Bush / Shaft Pro Top Cover / Plastic Cover / Brake Adj Brake Adjuster Gear (Small) / Spring (Ad.Cal. Bolt Rubber

Shaft L / Shaft Bearing Bed L / Caliper Gear (Big) L / Ball Bearing / Shaft Roller Bearing / Waved Washer / Spring (Big) L / Shaft Bush / Shaft Protective Plastic / Top Cover / Plastic Cover / Brake Adjuster Calib. Bolt / Brake Adjuster Gear (Small) / Spring (Small) L / Brake Ad.Cal. Bolt Rubber

Brake Caliper Repair Kit

Brake Caliper Repair Kit

dph-no. OEM-no.

application

dph-no. OEM-no.

application

1259955 LRG533



Caliper Spline Shaft, Rear Right
MERCEDES O403 / O404

26 Teeth

1259960 LRG524
LRG528
LRG532
LRG622



Caliper Gear Big, Rear Left

1259956 LRG532



Caliper Spline Shaft, Rear Left
MERCEDES O403 / O404

26 Teeth

1259961 LRG525
LRG529
LRG533
LRG623



Caliper Repair Kit

Brake Adjuster Calib. Bolt
Brake Adjuster Gear (Small)
Spring (Small) R
Brake Ad.Cal. Bolt Rubber

1259957 LRG525
LRG529
LRG533
LRG623



Caliper Spline Shaft Bearing, Rear Right

1259962 LRG524
LRG528
LRG532
LRG622



Caliper Repair Kit

Brake Adjuster Calib. Bolt
Brake Adjuster Gear (Small)
Spring (Small) L
Brake Ad.Cal. Bolt Rubber

1259958 LRG524
LRG528
LRG532
LRG622



Caliper Spline Shaft Bearing, Rear Left

1259963 LRG524
LRG525
LRG528
LRG529
LRG532
LRG533
LRG622
LRG623



Caliper Ball Bearing

1259959 LRG525
LRG529
LRG533
LRG623



Caliper Gear Big, Rear Right

1259964 LRG524
LRG525
LRG528
LRG529
LRG532
LRG533
LRG622
LRG623



Caliper Shaft Roller Bearing

Brake Caliper Repair Kit

Brake Caliper Repair Kit

dph-no. OEM-no.

application

dph-no. OEM-no.

application

1259965 LRG524
LRG525
LRG528
LRG529
LRG532
LRG533
LRG622
LRG623



Caliper Waved Washer

1259970 LRG702
LRG703



Caliper Adjusting Mechanism Cover
Aluminium

1259966 LRG524
LRG525
LRG528
LRG529
LRG532
LRG533
LRG622
LRG623



Caliper Cover and Boots

1259971 LRG702
LRG703



Caliper Adjusting Mechanism Gear

1259967 LRG524
LRG525
LRG528
LRG529
LRG532
LRG533
LRG622
LRG623



Caliper Pin Repair Kit
Caliper Pin (Long) 32x107 x1
Caliper Pin (Short) 32x73 x1
Pin Bolt M18x1.5 - 105mm x1
Pin Bolt M18x1.5 - 90mm x1
Pin Dust Rubber (Grey) x2
Pin Dust Metal Sheet x2
Pin Cap x2
Caliper Pin Bush (Short) x2
Caliper Pin Bush (Long) x1

1259972 LRG702
LRG703



Caliper Adjusting Mechanism

1259968 LRG532
LRG533



Caliper Brake Pad Plate
MERCEDES O403 / O404

1259973 LRG703



Caliper Adjusting Gear, Left

1259969 LRG702
LRG703



Caliper Adjusting Mechanism Set

1259974 LRG702



Caliper Adjusting Gear, Left

Brake Caliper Repair Kit

dph-no. OEM-no.

application

Brake Caliper Repair Kit

dph-no. OEM-no.

application

1259975 LRG702
LRG703



Caliper Lever

1259986 MCK1139
LRG544 / LRG545
LRG572 / LRG573
LRG638 / LRG639
LRG703 / LRG702

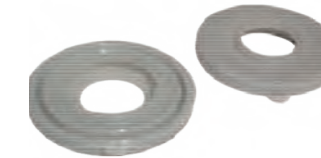

Caliper Pin Dust Rubber Set

1259976 LRG702
LRG703



Caliper Roller Bearing Set

1259842 LRG542 / LRG543
LRG570 / LRG571
LRG586 / LRG587
LRG588 / LRG589
LRG590 / LRG591
LRG632 / LRG633
LRG642 / LRG643



Caliper Adjusting Cover
MAN

1259977 LRG703



Caliper Bearing Cap

1259843 LRG543 / LRG571
LRG589 / LRG591
LRG633/ LRG643



Caliper Gear, Right (37,50mm)
MAN

1259978 LRG702
LRG703



Caliper Pin Repair Kit

1259844 LRG542 / LRG570
LRG588 / LRG590
LRG632 / LRG642

Caliper Pin (Long) 35x144 x1
Caliper Pin (Short) 31x84 x1
Pin Dust Rubber (Big) x1
Pin Dust Rubber (Small) x2
Pin Bush (Thin) 35x39x30 x2
Pin Cap x2
Pin Rubber Bush x1



Caliper Gear, Left (35mm)
MAN

1259979 LRG702
LRG703



Caliper Pin Rubber Bush

1259845 LRG542 / LRG543
LRG570 / LRG571
LRG586 / LRG587
LRG588 / LRG589
LRG590 / LRG591
LRG632 / LRG633
LRG642 / LRG643



Caliper Adjusting Mechanism
MAN

Brake Caliper Repair Kit

Brake Caliper Repair Kit

dph-no.	OEM-no.	application	dph-no.	OEM-no.	application
1259846	LRG543 / LRG571 LRG589 / LRG591 LRG633 / LRG643	 Caliper Adjusting Mechanism MAN	1259851		 Caliper Pin Repair Kit (old model) Caliper Pin (Long) 35x135 x1 Caliper Pin, with Bolt 33x110 x1 Pin Bolt M20x1.5 - 150mm x1 Pin Bush 35x39x30 / Pin Cap x2 Pin Ring (Short) x1 Pin Ring (Long) x1 Pin Dust Rubber (Small) x2 Pin Dust Rubber (Big) x1 Rubber Bush (Black) x1
1259847	LRG542 / LRG543 LRG588 / LRG589 LRG632 / LRG633	 Caliper Adjusting Mechanism MAN	1259852	SJ4114 LRG549 / LRG551 LRG555 / LRG593 LRG631	 Caliper Adjusting Mechanism, Right
1259848	MCK1102 LRG542 / LRG543 LRG570 / LRG571 LRG586 / LRG587 LRG588 / LRG589 LRG590 / LRG591 LRG632 / LRG633 LRG642 / LRG643	 Caliper Pin Repair Kit Caliper Pin (Long) 35x135 x1 Caliper Pin (Short) 35x73 x1 Pin Bolt M20x1.5 - 150mm x1 Pin Bolt M20x1.5 - 88mm x1 Pin Bush 35x39x30 x2 Pin Cap x2 Pin Ring (Short) x1 Pin Ring (Long) x1 Pin Dust Rubber (Grey) x2 - Pin Bush x1	1259853	SJ4113 LRG548 / LRG550 LRG554 / LRG592 LRG630	 Caliper Adjusting Mechanism, Left
1259849	ST1156	 Caliper Pin Dust Rubber Set (old model) MAN	1259854	SJ4074 LRG549 / LRG551 LRG555 / LRG593 LRG631	 Caliper Adjusting Gear Big, Right
1259850		 Caliper Pin Repair Kit Caliper Pin (Long) 35x135 x1 Caliper Pin (Short) 35x73 x1 Pin Bolt M20x1.5 - 150mm x1 Pin Bolt M20x1.5 - 88mm x1 Pin Bush 35x39x30 x2 Pin Cap x2 Pin Ring (Short) x1 Pin Ring (Long) x1 Pin Dust Rubber (Small) x2 Pin Dust Rubber (Big) x1 - Pin Bush x1	1259855	SJ4073 LRG548 / LRG550 LRG554 / LRG592 LRG630	 Caliper Adjusting Gear Big, Left

Brake Caliper Repair Kit

Clutch Master Cylinder Repair Kit

dph-no.	OEM-no.	application	dph-no.	OEM-no.	application
1259856		<p>Caliper Pin Repair Kit VOLVO FH RVI</p> <p>Caliper Pin 35x100 x2 Pin Bush (Long) x1 Pin Bush 35x39x30 x2 Pin Dust Rubber (Big) x1 Pin Dust Rubber (Small) x2</p>	1244292	000 586 52 29 RK19563 RK197008 S5091	Clutch Master Cylinder Repair Kit
1259857		<p>Caliper Pin Repair Kit VOLVO FH RVI</p> <p>Pin Bush (Long) x1 Pin Bush 35x39x30 x2 Pin Dust Rubber (Big) x1 Pin Dust Rubber (Small) x2</p>	1259490	000 290 03 12 000 290 09 67 RK19790 S5516	<p>Clutch Master Cylinder Repair Kit</p> <p>123 200-300 (W123) 76 -> 86 124 200-500 (W124) 85 -> 06-93 124-201-202-210 190 (W201) 10-82 -> 08-93 C-CLASS (T202) 6-96->3-01 C-CLASS (W202) 3-93->5-00</p>
1259858		<p>Caliper Pin Dust Rubber Set VOLVO FH RVI</p>	1259491	000 290 33 12 RK197009 S5165	<p>Clutch Master Cylinder Repair Kit</p> <p>207D,410D T1/TN 407-410</p>
			1259492	000 290 23 12 RK197006 S5421	<p>Clutch Master Cylinder Repair Kit</p> <p>507D 814D MB800</p>
			1259493	000 290 18 11 RK22808K S6761 2D0 798 118	<p>Clutch Master Cylinder Repair Kit</p> <p>SPRINTER VITO</p>

Clutch Master Cylinder Repair Kit

Clutch Master Cylinder Repair Kit

dph-no.	OEM-no.	application	dph-no.	OEM-no.	application
1259494	000 290 12 12 RK22757 S5372	Clutch Master Cylinder Repair Kit Ø 22.2mm 1848 2624 2629 2631	1259499	000 290 06 11 000 290 28 67 RK23809K S6026	Clutch Master Cylinder Repair Kit Ø 23,81mm C-Series (W202) (03.1993-05.2000) KOMBI (S123) (09.1977-12.1985) 190 (W201) (10.1982-08.1993) CLK Cabriolet (A208) (03.1998-03.2002)
1259495	KG2395.1.2 KG2395.1.3 KG2395.1.4 RK23726 11009890 000 290 34 12	Clutch Master Cylinder Repair Kit NG 8-73->9-96 O 303-307 Series 4-73->9-92 SK 7-87->9-96 UNIMOG 01-66 ->	1259501	81.30715.6113 RK23722 S5536 S5571	Clutch Master Cylinder Repair Kit F2000 F90 LION S STAR M90
1259496	215 00 494 000 290 34 12 RK23726 S5185 11009890	Clutch Master Cylinder Repair Kit Ø 23,81mm 26189 LK/LN2 (01.1984-12.1998) MB-TRAC (07.1973-12.1991) NG (08.1973-09.1996) SK (07.1987-09.1996) UNIMOG (01.1966-)	1259500	RK25703 S5315	Clutch Master Cylinder Repair Kit 2 - Series (05.1980-05.1988) 82/92/112 550 440
1259497	KG2395.1.7 RK RK23714 S5185 KG23028.0.1 RK 000 290 46 67	Clutch Master Cylinder Repair Kit Ø 23,81mm LK/LN2 (01.1984-12.1998) NG (08.1973-09.1996) O 404 (09.1991-10.1999) SK (07.1987-09.1996) TOURISMO (O 350) (09.1994-)	1424690	RK25440 S5524	Clutch Master Cylinder Repair Kit 2 - Series (05.1980-05.1988) 3 - Series (01.1988-12.1996) 4 - Series (09.1995-09.2004)
1259498	99707006766 000 290 05 12 000 290 23 67 RK23716 RK23719 S5372	Clutch Master Cylinder Repair Kit Ø 23,81mm LK/LN2 (01.1984-12.1998) O 301 (09.1985-12.1987) O 402 (10.1985-12.1991)	1259502	1237496 696264 RK25717 S5171	Clutch Master Cylinder Repair Kit F1100 F2500 F1300 F2800 F1600 F3300 F1700 F3600 F1900 F2100 F2200 F2300

Clutch Master Cylinder Repair Kit

Clutch Master Cylinder Repair Kit

dph-no.	OEM-no.	application	dph-no.	OEM-no.	application
1259503	RK25718 S5554 81.30715.6145	 <p>Clutch Master Cylinder Repair Kit Ø 25,4mm</p> <p>12.153 L2000 LION S COACH LION S COMFORT LION S STAR M2000 L</p>	1259508	1237505 RK28706 S5505	 <p>Clutch Master Cylinder Repair Kit</p> <p>75 (07.1992-02.1998) 85 (07.1992-02.1998) 95 (09.1987-01.1998)</p>
1259504	000 586 33 29 RK25060 S6189	 <p>Clutch Master Cylinder Repair Kit Ø 25,4mm</p>	1243025	RK28710 S5547 271 106 271 106-7 276 834 3 094 523 3 094 523-2	 <p>Clutch Master Cylinder Repair Kit Ø 28,57mm</p> <p>F 10 (08.1977-12.1994) FH 12 (08.1993-) FH 16 (08.1993-) FL 10 (09.1985-09.1998) FL 12 (09.1995-09.1998) FL 7 (09.1985-09.1998) FM 12 (08.1998-09.2005) - NH 12 (05.1</p>
1259505	81.30715.6100 81.30715.6126 RK25714 S5346	 <p>Clutch Master Cylinder Repair Kit</p> <p>G (10.1979-08.1988) G 90 (09.1987-05.1995)</p>	1259509	81.30716.6020 81.30716.6033 81.30716.6046 81.30716.6057 S6271 5000 589 359	 <p>Clutch Master Cylinder Repair Kit Ø 28,57mm</p>
1259506	000 586 60 29 RK2604 S5373	 <p>Clutch Master Cylinder Repair Kit</p> <p>1635 1935 1938 2635 NG (08.1973-09.1996)</p>	1259510	RK28710 S5269 271106 276834	 <p>Clutch Master Cylinder Repair Kit</p> <p>FH 12 (08.1993-) FH 16 (08.1993-) FL 10 (09.1985-09.1998) FL 12 (09.1995-09.1998) FL 7 (09.1985-09.1998) FM 12 (08.1998-09.2005) NH 12 (05.1999-)</p>
1259507	8.282.211.000 8.282.211.000D RK26504-1 S5054	 <p>Clutch Master Cylinder Repair Kit</p>	1259511	81.30716.6068 81.30716.6071 RK28814K S6369	 <p>Clutch Master Cylinder Repair Kit Ø 28,57mm</p> <p>G (10.1979-08.1988)</p>

Clutch Master Cylinder Repair Kit

Clutch Master Cylinder Repair Kit

dph-no.	OEM-no.	application	dph-no.	OEM-no.	application
1259513	000 290 14 67 000 290 37 67 RK28812K S6469	Clutch Master Cylinder Repair Kit LK/LN2 (01.1984-12.1998)	1259517	000 290 05 11 000 290 14 11 RK33801K S6578	Clutch Master Cylinder Repair Kit Ø 33,34mm O 303 (10.1974-09.1992) O 340 (01.1991-06.1995)
1259514	000 290 24 67 000 290 45 67 RK28813K S6486	Clutch Master Cylinder Repair Kit Ø 28,57mm LK/LN2 (01.1984-12.1998) NG (08.1973-09.1996) T2/LN1 (03.1986-12.1994) UNIMOG (01.1966-)	1259518		Clutch Master Cylinder Repair Kit Ø 34,92mm SG (09.1972-) SL (06.1972-04.1987) SR (02.1975-08.1994) SÜ (10.1975-)
1259512	000 586 38 29 RK28021 S6205	Clutch Master Cylinder Repair Kit Ø 28,57mm LP (09.1963-12.1984) T2/L (01.1968-12.1988)	1259519	RK38003K 1506121 1545626 1754943	Clutch Master Cylinder Repair Kit Ø 38,1mm G508-2 4 - Series (09.1995-09.2004) P,G,R,T - Series (03.2004-)
1259515	000 290 12 11 000 290 40 67 RK31806K S6481	Clutch Master Cylinder Repair Kit Ø 31,75mm LK/LN2 (01.1984-12.1998) MK (12.1987-09.1996) NG (08.1973-09.1996) O 303 (10.1974-09.1992) O 407 (03.1987-11.2001) O 408 (09.1989-12.1998)	1259520	000 290 09 11 000 586 31 29 RK38816K S6197	Clutch Master Cylinder Repair Kit Ø 38,1mm NG (08.1973-09.1996) O 303 (10.1974-09.1992) O 305 (09.1967-07.1977) O 307 (04.1973-12.1987) SK (07.1987-09.1996)
1259516	81.30716.6064 RK31019K S6207	Clutch Master Cylinder Repair Kit Ø 31,75mm SR (02.1975-08.1994) SÜ (10.1975-)	1259521	1373532 626762AM RK. 627201AM	Clutch Master Cylinder Repair Kit Ø 22mm

Clutch Master Cylinder Repair Kit

Brake Master Cylinder Repair Kit

dph-no.	OEM-no.	application	dph-no.	OEM-no.	application
1259522	1373531 626760AM RK. 6267200AM	Clutch Master Cylinder Repair Kit Ø 26mm	1259524	000 430 21 83 000 586 66 43 RK2224 S5215	Brake Master Cylinder Repair Kit Ø:22,2mm
1259523	KG3105.0.1 RK.	Clutch Master Cylinder Repair Kit Ø 31,75mm TURBOTECH (01.1990-01.1993) TURBOSTAR (07.1984-12.1993)	1259525	000 431 47 01 RK23969 2D0 611 019 A	Brake Master Cylinder Repair Kit Ø 23,81mm SPRINTER 2-T SPRINTER 3-T SPRINTER 4-T LT 28-35 II LT 28-46 II LT 28-46 II
			1259526	004 430 96 01 RK3198 S5040	Brake Master Cylinder Repair Kit Ø 31,75mm LP (09.1963-12.1984)
			1259527	1 695 073 02960656 8.282.192.828 5 603 270 000 586 17 43 RK3452 S406	Brake Master Cylinder Repair Kit Ø 34,92mm MB-TRAC (07.1973-12.1991) NG (08.1973-09.1996) O 303 (10.1974-09.1992)
			1458060	000 586 44 43 RK3164 S5085	Brake Master Cylinder Repair Kit Ø 31,75mm LP (09.1963-12.1984)

Clutch Servo Unit Repair Kit

Clutch Servo Unit Repair Kit

dph-no. OEM-no.

application

dph-no. OEM-no.

application

1259528 628368AM



Clutch Servo Unit Repair Kit
628027AM
MAN 81.30725.6097
ø100

1259533 626731AM



Clutch Servo Unit Repair Kit
625384AM
626853AM
RVI 5001843793
ø80

1259529 329327AM



Clutch Servo Unit Repair Kit
627052AM
620361AM
MAN 81.30725.6102
MAN 81.30725.6103
ø100

1259534 628304AM



Clutch Servo Unit Repair Kit
628276AM
628277AM
DAF 1443525
ø95

1259530 622427AM



Clutch Servo Unit Repair Kit
625586AM
MAN 81.30725.6061
ø100

1259535 626787AM



Clutch Servo Unit Repair Kit
628275AM
628447AM
628450AM
DAF 1348878
ø100

1259531 626729AM



Clutch Servo Unit Repair Kit
626162AM
RVI 5001843783
ø100

1259536 628305AM



Clutch Servo Unit Repair Kit
628258AM
628259AM
628260AM
628448AM
628449AM
DAF 1443527
ø100

1259532 626773AM



Clutch Servo Unit Repair Kit
625524AM
RVI 5001843797
ø100

1259537 628476AM



Clutch Servo Unit Repair Kit
628492AM
628493AM
628494AM
629276AM
629277AM
VOLVO 85102142
VOLVO 85107959
ø100

Clutch Servo Unit Repair Kit

Clutch Servo Unit Repair Kit

dph-no.	OEM-no.	application	dph-no.	OEM-no.	application
1259538	627182AM	Clutch Servo Unit Repair Kit 626639AM VOLVO 3093100 ø95	1259541	622158AM	Clutch Servo Unit Repair Kit 622107 AM 622109 AM SCANIA 550453 ø95 NEW MODEL
1259539	627366AM	Clutch Servo Unit Repair Kit 626639AM 626669AM VOLVO 3093099 ø95	1247429	970 051 904 2	Clutch Servo Unit Repair Kit DAF 0698529 MAN 85.30001.9898 IVECO 0819 0167 NEOPLAN 040320201 MERCEDES 000 290 02 47 ø80
1259540	626703AM	Clutch Servo Unit Repair Kit 626392AM VOLVO 851102140 ø80	1247430	970 051 905 2	Clutch Servo Unit Repair Kit MAN 81.30725.6040 IVECO 0812 4364 ø80
1256179	625282AM	Clutch Servo Unit Repair Kit 622190AM 622199AM 624199AM SCANIA 550465 ø100	1259542	970 051 002 2	Clutch Servo Unit Repair Kit DAF 694288 EVO-BUS 83832311920 MERCEDES 000 290 06 67 ø90
1244135	622135AM	Clutch Servo Unit Repair Kit 622107 AM SCANIA 550422 ø95 OLD MODEL	1244177	970 051 903 2	Clutch Servo Unit Repair Kit DAF 1506469 EVO-BUS 83832401960 MERCEDES 000 290 32 67 ø90

Clutch Servo Unit Repair Kit

dph-no. OEM-no.

application

1259543 970 051 917 2



Clutch Servo Unit Repair Kit
MERCEDES 000 250 03 62
ø90

1247645 970 051 906 2



Clutch Servo Unit Repair Kit
DAF 1519288
IVECO 0812 4872
SCANIA 550457
MERCEDES 000 295 06 60
RVI 50008814928
ø100

1259544 970 051 944 2



Clutch Servo Unit Repair Kit
DAF 15119291
IVECO 9316 1820
RVI 5001842847
ø108

1259545 970 051 916 2



Clutch Servo Unit Repair Kit
DAF 1519290
MERCEDES 000 290 03 47
ø108

1259546 970 051 951 2



Clutch Servo Unit Repair Kit
DAF 1506471
MAN 81.30725.6082
ø75

Clutch Servo Unit Repair Kit

dph-no. OEM-no.

application

1259547 970 051 943 2



Clutch Servo Unit Repair Kit
MAN 81.30725.6079
ø100

1259548 970 051 949 2



Clutch Servo Unit Repair Kit
DAF 1519292
ø100

1259549 970 051 953 2



Clutch Servo Unit Repair Kit
RVI 5001842840
ø100

1259550 970 051 974 2



Clutch Servo Unit Repair Kit
MERCEDES 000 250 01 62
ø108

1259551 970 051 984 2



Clutch Servo Unit Repair Kit
DAF
IVECO
RVI

Clutch Servo Unit Repair Kit

Clutch Servo Unit Repair Kit

dph-no. OEM-no.

application

dph-no. OEM-no.

application

1259552 970 051 987 2



Clutch Servo Unit Repair Kit
MERCEDES 000 255 07 62
ø108

1259556 | 90586



Clutch Servo Unit Repair Kit
VG 3208
MAN 81.30725.6042
ø100

1259553 970 051 961 2



Clutch Servo Unit Repair Kit
DAF 1519294
MAN 81.30725.6091
ø108

1259557 | 92489/008



Clutch Servo Unit Repair Kit
VG 3213
MAN
MERCEDES
ø100

1259554 | 84613



Clutch Servo Unit Repair Kit
VG 3200
MAN 81.30725.6030
ø75

1259558 | 31733/008



Clutch Servo Unit Repair Kit
VG 3261
MAN 81.30725.6080
ø100

1260497 | 833345/008



Clutch Servo Unit Repair Kit
VG 3204
DAF 1228092
IVECO 0812 4659
RVI 5001014246
ø75

1259559 | 35696/008



Clutch Servo Unit Repair Kit
VG 3264
VG 3269
IVECO 00123167
IVECO 93162130

1259555 | 7767/008



Clutch Servo Unit Repair Kit
VG 3262
MAN
MERCEDES
ø75

1259560 | 14195/008



Clutch Servo Unit Repair Kit
VG 3361
MERCEDES 000 290 10 47

Clutch Servo Unit Repair Kit

dph-no. OEM-no.

1259561 | 117771/008



Clutch Servo Unit Repair Kit
VG 3364
IVECO 93161893

Load Sensing Limiting Valve Repair Kit

dph-no. OEM-no.

1259461 475 710 000 2



Load Sensing Limiting Valve Repair Kit
DAF 1518945
MAN 81.52161.6367
VOLVO 3090924
MERCEDES 000 430 37 07

1259462 475 714 000 2



Load Sensing Limiting Valve Repair Kit
DAF FBU5577
IVECO 93161487

1259564 475 712 000 2



Load Sensing Limiting Valve Repair Kit
DAF 1518974
RVI 5021170231
FRUEHAUF CF3512812

1259565 475 713 000 2



Load Sensing Limiting Valve Repair Kit
IVECO 8124818

1259566 BR5504



Load Sensing Limiting Valve Repair Kit
SEB22188

EBS & ABS Modulator Repair Kit

EBS & ABS Modulator Repair Kit

dph-no. OEM-no.

application

dph-no. OEM-no.

application

1259586 R.K. K0212 *



EBS One Channel Module Repair Kit
K021202
K021204
K021203

1259591 R.K. 480 102 ***



EBS Trailer Control Module Repair Kit
480 102 014 0

1259587 R.K. 0 486 204 ***

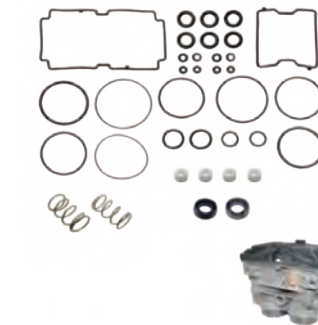

EBS Two Channel Module Repair Kit
0 486 204 025
0 486 204 021
0 486 204 019
0 486 204 017
0 486 204 All Series

1259592 R.K. 950 364 ***



ABS Modulator Valve Repair Kit
950 364 046
950 364 047
950 364 048
950 364 806
950 364 807

1259588 R.K. K0320 **



EBS Two Channel Module Repair Kit
K032014
K020024
K020023

1259593 R.K. BR91-92



ABS Modulator Valve Repair Kit
BR9232
BR9131
BR9132
BR9133
BR9150
BR9151
BR9152

1259589 R.K. 0 486 205 ***



EBS Trailer Control Module Repair Kit
0 486 205 022
0 486 205 020
0 486 205 001
0 486 205 002
0 486 205 004
0 486 205 All Series

1259594 R.K. 950 364 211



ABS Sps Valve Repair Kit
950 364 211
DAF
IVECO
MERCEDES
NEOPLAN

1259590 R.K. K0206 **



EBS Trailer Control Module Repair Kit
K020623
K020624

1259595 R.K. 480 202 ***















Proportional Relay Valve Repair Kit
480 202 007 0
480 202 001 0
480 202 002 0
480 202 004 0
480 202 005 0

EBS & ABS Modulator Repair Kit

dph-no.	OEM-no.	application
1259596	R.K. 472 195 ***	<p>ABS Relay Valve Repair Kit</p> <p>472 195 040 0 472 195 042 0 472 195 043 0 472 195 044 0 472 195 020 0 472 195 All Series</p>
1259597	1 487 010 371	<p>EBS One Channel Module Repair Kit</p> <p>0 486 203 034 0 486 203 026 0 486 203 024 0 486 203 023 0 486 203 031 0 486 203 All Series</p>
1259598	R.K. 472 195 ***	<p>ABS Solenoid Modulator Valve Repair</p> <p>472 195 000 0 472 195 001 0 472 195 002 0 472 195 003 0 472 195 004 0 472 195 005 0 472 195 All Series MERCEDES - RVI - VOLVO</p>
1259599	472 900 002 2	<p>ECAS Solenoid Valve Repair Kit</p> <p>472 900 001 0 472 900 002 0 472 900 008 0 472 900 012 0 472 900 All Series MAN MERCEDES RVI</p>
1259600	R.K. 472 880 ***	<p>ECAS Solenoid Valve Repair Kit</p> <p>472 880 001 0 472 880 004 0 472 880 024 0 472 880 061 0 DAF</p>

Overview of most popular oil seal types acc to DIN 3760 / 3761

Application	Description	Application	Description
	rubber version with single lip		metal cased open
	rubber version with sealing and dust lip		metal cased open with dust lip
	rubber version with 2 lips and 2 springs		metal cased closed
	rubber version with sealing lip and corrugated profile		metal cased closed with dust lip
	rubber version with sealing lip and dust lip and corrugated profile		metal cased open with 2 lips
	seal with combined elastomer/metal outer cover		seal with combined elastomer/metal outer cover with dust lip

Abbreviations at „style“

FL Washer
PR Profile seal
OR O-Ring
WR Oil seal

Complimentary definitions

RD Right hand helix
LD Left hand helix
WD Double helix
SF Special design
OF Without spring

Abbreviations at „mat“ (material)

ACM Polyacrlyl rubber
FPM Fluor rubber (Viton)
MVQ Silicone rubber
NBR Nitril rubber EPDM
Ethylen-Propylen-

PTFE Polyterafluoren-ethylen
HNBR Hydrogenated NBR
AL Aluminium
CU Copper

SCANIA

Spare parts for trucks

Qualität - made by
dph Germany



Dichtungspartner Hamburg

Important notes

- 1.** This catalogue replaces all previous issues.
- 2.** The catalogue is protected by copyright.
The duplication of it or any part of it is prohibited.
- 3.** The supply of dph components strictly adhere to our sales and delivery agreement and are subject to our conditions of payment.
- 4.** We reserve the right to modify our components as necessary.
- 5.** The original equipment part numbers, as well as SLP, Elring-No., etc. indicated in the catalogue only serve as a cross-reference comparison with dph numbers. They must not appear on any advice notes or invoices.
- 6.** All original part numbers of engine or vehicle manufacturers in this catalogue are mentioned for comparison reasons only and should not be used in contacts with vehicle owners.
- 7.** Every effort has been made to ensure that the information in this catalogue is correct at the time of printing, but dph cannot accept any responsibility for errors which may occur.

Qualität – made by dph Germany



Dichtungspartner Hamburg

High quality guarantees growing success



We have always supplied our customers with high quality seals for the following sectors: Automobile, hydraulic seals, mountings and other fields all at reasonable prices and quick delivery. We can count many well-known companies throughout the world as satisfied customers.

Four strategies guarantee our success:

- First rate products with top class quality assured
- Short delivery times due to our own stock levels
- Flexibility in the procurement of all parts
- Attractive pricing policy



Fully automated electronic quality checks and manufacturing to DIN standards guarantee continuous high quality products. To your advantage and always at very fair prices.

Perfect manufacturing and continuous quality assurance

Together we are strong – this is the maxim in our group. High quality is not achieved just as a result of monitoring but of production technique. Therefore, Dichtungspartner Hamburg receives the bulk of its products from OEM suppliers and from suppliers whose quality management is certified in accordance with DIN/ISO 9000/9001.

Despite this, we still think it is necessary to check the finished products thoroughly once more within our group according to DIN/ISO 9001. Our high-grade measuring instruments are checking the radial force of oil seals, the tensile strength of elastomers, the compression set and the surface quality by means of computer-based cameras and many more. The results of the checks are registered and filed. It is good to have confidence but qualification is better!

Contents

	OEM numbers, reference list	6 – 13
	Engine gaskets and gasket sets	14 – 24
	Cylinder head gaskets & sets, cylinder liner sealing rings & kits, complete gasket sets, valve cover gaskets, oil pan gaskets & kits, manifold gaskets, gaskets flywheel, full sets	
	Engine parts, fuel, exhaust and cooling system parts	25 – 44
	Oil seals, washers, o-rings/seal rings, gaskets, repair kits compressor (engine) oil seals for hubs & wheels, oil seals crankshaft, cylinder liner shims	
	Rubber cushions for engine, exhaust systems and gearbox	45 – 46
	Oil seals, gaskets	
	Clutch, gearbox	47 – 48
	Servo cylinders, repair kits, o-rings, oil seals	
	Brake parts	49 – 56
	Oil seals, valve lifter, valve guide, valves, repair kits, diaphragms	
	Front and rear axle parts, steering	57 – 60
	Oil seals, gaskets	
	Front and rear suspension parts	61 – 62
	Bushings, o-rings	
	Hose	63
	Overview of most popular oil seal types	64
	Standard terms and conditions	65 – 66

OEM numbers, reference list

OEM-no.	dph-no.	description	page	
-	50826	Cylinder liner sealing ring kit	16	
-	95842	Cylinder liner sealing ring kit	17	
1 100 645	109531	Oil seal brake part	55	
1 101 276	70432	Gasket flywheel/gear housing	23	
1 103 236	82835	Repair kit/compressor (engine)	41	
1 103 422	replaced by 1 116 635	Valve lifter	50	
1 107 097	80236	O-ring/seal ring – engine	31	
1 107 098	80411	O-ring/seal ring – engine	31	
1 108 223	81677	Repair kit/compressor (engine)	41	
1 108 228	(300 162)	81715	Repair kit	41
1 109 288	70434	Manifold gasket	22	
1 109 869	82871	Oil seal – engine	25	
1 109 870	replaced by 310 951	Oil seal – engine	25	
1 114 036	33008	Cylinder liner shim	43	
1 116 635	(1 103 422, 131 105)	51307	Valve lifter	50
1 301 628	70435	Manifold gasket	22	
1 301 629	70436	Manifold gasket	22	
1 302 243	80404	O-ring/seal ring – engine	32	
1 302 556	97850	Gasket	34	
1 302 827	36768	Gasket	34	
1 302 828	(170 951)	36769	Cylinder liner sealing ring	17
1 303 673	replaced by 1 363 673	Oil seals front and rear axle, steering	59	
1 303 789	98260	O-ring/seal ring – engine	32	
1 304 293	104348	Gasket seal – engine	37	
1 305 139	97851	Gasket	46	
1 305 341	70437	Gasket for steering	57	
1 305 595	84528	Gasket	34	
1 305 596	84529	Gasket seal – engine	36	
1 305 597	84530	Gasket seal – engine	37	
1 305 673	97849	Gasket seal – engine	37	
1 305 959	(170 610)	94530	Valve cover gasket	18
1 307 340	replaced by 1 338 018	Brake part/front-/rear wheel brake	50	
1 312 934	111269	Cylinder liner sealing ring kit	16	
1 312 934	(323 641, 177 587)	4212	Cylinder liner sealing ring	17
1 313 459	70438	Cylinder head gasket	14	
1 315 437	98261	O-ring/seal ring – engine	32	
1 318 388	96716	Oil seal	45	
1 319 081	98679	Valve intake	51	
1 320 298	70442	Gasket	46	
1 327 886	82836	Repair kit	41	
1 329 585	97852	Gasket	46	
1 331 770	(371 612)	81803	Clutch servo cylinder	47
1 334 294	97290	O-ring/seal ring – engine	32	
1 334 535	93430	Oil seal front and rear axle, steering	60	
1 335 243	84730	Oil seal front and rear axle, steering	60	
1 336 159	(550 455/6)	51926	Repair kit clutch servo	47
1 338 018	(1 307 340)	104111	Brake part/front-/rear wheel brake	50
1 338 019	(391 962)	69230	Brake part front-/rear wheel brake	49
1 342 363	93428	Oil seal front and rear axle, steering	60	
1 343 372	109530	Oil seal brake part	55	
1 345 278	95457	Oil seal – engine	26	
1 345 279	96311	Oil seal	55	
1 349 018	98264	O-ring/seal ring – engine	32	
1 349 089	95458	Oil seal – engine	26	
1 350 378	70443	Gasket	35	

OEM-no.	dph-no.	description	page
1 350 379	70444	Gasket	35
1 350 380	70445	Gasket	35
1 360 833 (366 256)		Valve exhaust	52
1 360 834 (352 347)		Valve exhaust	52
1 360 836	110771	Valve intake	51
1 361 189 (272 803)		Valve intake	51
1 361 190	110773	Valve intake	51
1 361 195	110772	Valve exhaust	52
1 361 197 (243 477)		Valve exhaust	52
1 363 673 (1 303 673)	96111	Oil seals front and rear axle, steering	59
1 363 674 (1 309 342)	82497	Oil seal front and rear axle, steering	60
1 367 027	104470	Valve cover gasket	19
1 367 028	104471	Valve cover gasket	19
1 374 326	111443	Gasket seal – engine	37
1 374 327	111445	Gasket seal – engine	38
1 374 334	111442	Gasket seal – engine	38
1 374 338		Manifold gasket	23
1 374 340		Manifold gasket	23
1 374 344	111446	Gasket seal – engine	38
1 375 002	111452	Oil seal – crankshaft	40
1 375 383	111444	Gasket seal – engine	38
1 377 039		Cylinder head gasket	14
1 380 834	93808	O-ring/seal ring – engine	33
1 383 129	95649	Oil seal differential bevel pinion	60
1 384 004		Gasket seal – engine	38
1 384 552		Manifold gasket	22
1 386 594	98061	Oil seal differential bevel pinion	60
1 388 678	95969	Gasket seal – engine	38
1 388 683		Gaskets flywheel/gear housing	24
1 392 936 (371 500)	96313	Gasket	46
1 393 331	98060	Oil seals front and rear axle, steering	59
1 395 999	109529	Oil seal brake part	55
1 398 810		O-ring kit – engine	33
1 401 982		Valve cover gasket	20
1 401 984	110342	Valve cover gasket	19
1 403 129	111440	Gasket seal – engine	38
1 403 258		Cylinder head gasket	14
1 403 260		Cylinder head gasket	14
1 403 587		Cylinder head gasket	14
1 404 306		Manifold gasket	23
1 409 889	112266	Oil seal brake part	55
1 409 890	112282	Oil seal brake part	55
1 411 851	109728	Valve cover gasket	20
1 412 666		oil pan gasket	20
1 414 422	109729	Valve cover gasket	20
1 422 564	111565	O-ring kit – engine	33
1 423 290	111441	Gasket seal – engine	38
1 433 183	111453	Oil seal – crankshaft	40
1 444 941 (1 403 260, 1 377 039)	104473	Cylinder head gasket	14
1 459 004		Oil pan gasket	20
1 460 359	111447	Oil pan gasket	20
1 476 506	109730	Valve cover gasket	20
1 502 384	111330	Oil seal brake part	56
1 502 384	111330	Oil seal differential bevel pinion	60
1 516 145		Manifold gasket	23

OEM-no.	dph-no.	description	page
1 516 474	111568	Manifold gasket	23
1 541 633		Gasket seal – engine	38
1 675 602	111231	Gasket seal – engine	38
120 310	61641	Oil seal for hubs and wheels	40
120 828	68810	Brake part front-/rear wheel brake	49
120 979 (227 138, 304 552)	70446	Oil seals front and rear axle, steering	59
121 257	70447	Oil seal for hubs and wheels	39
123 102	69284	Brake part front-/rear wheel brake	49
124 268 (388 728)	34426	Oil seals front and rear axle, steering	59
125 766	110713	Oil seals front and rear axle, steering	59
127mm	94742	Cylinder liner sealing ring kit	16
130 934-2		Oil seal front and rear axle, steering	60
131 039		Valve cover gasket	18
131 571		Valve cover gasket	19
132 672	82323	Oil seal – engine	25
135 036	70172	Shackle bushing	61
135 698	70448	Shackle bushing	61
136 083-6 (294 674)		Valve intake	51
136 106	70449	Oil seals front and rear axle, steering	59
136 119-5 (168 843)		Valve exhaust	52
137 207 (332 738)	82302	Rubber bushing	62
139 023	70450	Oil seal – engine	26
14 107	70451	Oil seal – engine	26
141 964	82837	Repair kit	42
143 112	69219	Diaphragm/Brake part	54
143 113	69220	Diaphragm/Brake part	54
143 118	69223	Diaphragm/Brake part	54
144 116	70452	Oil seals front and rear axle, steering	59
151 476	69218	Diaphragm/Brake part	54
159 496	34422	Oil seal for hubs and wheels	39
160 342	69217	Diaphragm/Brake part	54
165 507	70454	Washer – engine	29
168 843 (136 119-5)	93996	Valve exhaust	52
17 115	93997	Valve seal ring	52
17 543	93998	Valve seal ring	53
170 205	32990	Seal ring/cooling system	44
170 226	70455	Oil seal – engine	26
170 424	21255	O-ring/fuel system	44
170 610 replaced by 1 305 959	32906	Valve cover gasket	18
170 700-9 replaced by 371 505, 1 459 004		Oil pan gasket	20
170 761	70457	Oil seal – engine	25
171 566	69215	Diaphragm/Brake part	54
173 320	34423	Oil seal for hubs and wheels	39
174 229	32999	O-ring/seal ring – engine	32
177 587 (1 312 934, 323 641)	110487	Cylinder liner sealing ring	17
178 562	70460	Washer – engine	27
178 866	70461	Oil seals front and rear axle, steering	58
182 524	70463	Washer – engine	27
182 929	61342	O-ring for shackle pins	61
182 930	3889	Brake part front-/rear wheel brake	49
182 931	61343	O-ring for shackle pins	61
182 935	94398	O-ring/front axle	57
192 081	70464	Washer – engine	27
192 600	70465	Oil seal – engine	26
192 633	70466	Washer – engine	27

OEM-no.	dph-no.	description	page
192 651	70467	Washer – engine	27
192 820-9	70468	Washer – engine	27
192 871	98658	O-ring/fuel system	43
194 414	96197	O-ring/gearbox control	48
202 288	81457	Oil seal – engine	26
203 670	69213	Diaphragm/Brake part	54
204 466	70469	Washer – engine	27
204 750	95869	Gasket bogie axle	57
209 261	70470	Washer – engine	28
209 770	70471	Washer – engine	28
210 648	95850	Oil seal – engine	26
211 077	70472	Washer – engine	28
211 337 (216 608)	70473	Oil seals front and rear axle, steering	59
211 813	93836	O-ring/seal ring – engine	33
214 008	34425	Brake part front-/rear wheel brake	49
215 242-9 (371 503)	80016	Oil pan gasket	20
215 715	93995	Valve intake	51
216 608 replaced by 211 337		Oil seals front and rear axle, steering	59
227 138 (304 552, 120 979)		Oil seals front and rear axle, steering	59
229 373	81725	Repair kit	42
230 297	34434	Gasket seal – engine	37
231 938	34428	Oil seals front and rear axle, steering	59
232 018	61145	Valve exhaust	52
241 805	81973	Hose	63
242 672	61151	Valve seal ring	53
242 857	93837	O-ring/fuel system	43
243 477 (1 361 197)	98682	Valve exhaust	52
244 446	32996	O-ring/gearbox control	48
244 448	95851	Seal ring/wiper ring for gearbox	62
252 496	98656	O-ring/fuel system	43
254 635	70475	Oil seal	45
257 737	84526	O-ring/seal ring – engine	33
258 458	70476	Valve cover gasket	19
258 459-7	61109	Valve cover gasket	18
270 247	93994	Valve intake	50
272 803 (1 361 189)	98681	Valve intake	51
272 804	61144	Valve intake	50
276 587	81970	O-ring/seal ring – engine	32
277 272 (385 997)		Manifold gasket	22
277 273	70479	Manifold gasket	22
278 198	81716	Repair kit/compressor (engine)	41
280 759	84543	Oil seal – engine	26
282 501	81714	Repair kit	42
282 799	81717	Repair kit	42
289 517	61149	Valve seal ring	53
290 534 (372 984)	34620	O-ring/seal ring – engine	30
291 076	34427	Oil seal front and rear axle, steering	60
291 159		Cylinder head gasket	14
291 826	70315	Seal ring/cooling system	44
293 546	82816	Repair kit	43
294 275	84541	Oil seal	45
294 674 (136 083-6)	98678	Valve intake	51
297 991	70481	Oil seals front and rear axle, steering	58
297 999	61643	Oil seals front and rear axle, steering	59
298 021 (392 309)		O-ring/hubs and wheels	41

OEM-no.	dph-no.	description	page
300 162 (1 108 228)	82817	Repair kit	41
300 278	61645	Oil seal for hubs and wheels	39
300 957	61147	Valve guide	50
300 958	61148	Valve guide	50
303 098	70482	Washer – engine	27
304 552 (227138, 120979)		Oil seals front and rear axle, steering	59
309 113	98517	Oil seal for hubs and wheels	39
309 164-2	70814	Repair kit	42
309 164	82818	Repair kit air dryer drain valve	55
310 951 (1 109 870)	84537	Oil seal – engine	25
313 004	81718	Repair kit	42
313 114	82819	Repair kit/brake valve	53
314 063-9 (388 528)	70483	Oil seal/gearbox	48
315 022	81458	Seal ring/wiper ring for gearbox	62
315 270	95868	Gasket seal – engine	36
317 916	95647	Gasket seal – engine	36
318 415		Manifold gasket	22
319 475	81682	Repair kit/brake valve	53
319 477	81719	Repair kit	43
32 201	70484	Oil seal	45
32 898	70485	Oil seals front and rear axle, steering	58
321 991	80746	O-ring/seal ring – engine	33
321 992	97479	O-ring/seal ring – engine	32
323 451	69231	O-ring/seal ring – engine	30
323 641 (1 312 934, 177 587)	32970	Cylinder liner sealing ring	17
323 661		Cylinder liner sealing ring	17
323 662 (323 661)	32971	Cylinder liner sealing ring	17
329 583	81975	Vibration insulator (motor hood)	62
329 638	81460	Oil seal	45
33 326	70486	Oil seal brake part	56
33 352	3888	Oil seals front and rear axle, steering	58
330 323	70487	Washer – engine	28
332 448	84527	Gasket seal – engine	37
332 738		Rubber bushing	62
338 643	34421	Oil seals front and rear axle, steering	58
340 895	81971	Rubber bushing	62
342 989	36090	Cylinder liner sealing ring	17
344 426	22995	Valve cover gasket	19
345 362 (550 720)	81422	Clutch servo cylinder	47
346 143	69286	Cylinder head gasket	14
346 216		Cylinder head gasket	14
347 468	109532	Oil seal brake part	56
348 339	4147	Gasket seal – engine	37
349 353	80747	O-ring/seal ring – engine	33
35 528	70488	Washer – engine	28
352 347 (1 360 834)	98683	Valve exhaust	52
353 173	98692	Washer – engine	28
357 363	68531	Manifold gasket	23
360 717	81524	Clutch servo cylinder	47
361 523	80408	O-ring/seal ring – engine	33
361 526	80406	O-ring/seal ring – engine	33
362 128	34432	O-ring/seal ring – engine	33
362 129	94386	O-ring/seal ring – engine	33
364 791	70503	Manifold gasket	21
364 792	70490	Manifold gasket	21

OEM-no.	dph-no.	description	page
365 375	70491	Washer – engine	28
366 256 (1 360 833)	98680	Valve exhaust	52
366 303	69285	Oil seals front and rear axle, steering	58
366 539	70494	Oil pan gasket	20
366 546	70495	Gasket	46
366 547	70496	Manifold gasket	22
366 557	70501	Gasket	35
369 229	70502	Gasket seal – engine	35
369 276	70503	Manifold gasket	21
369 477	111285	Oil seal – crankshaft	40
369 478	111272	Oil seal – crankshaft	40
370 074	61647	Oil seals front and rear axle, steering	59
370 075	50176	Oil seal for hubs and wheels	40
370 076 (291 463)	50177	Oil seal for hubs and wheels	39
370 076	111548	Oil seal rear axle	60
371 483	70504	Valve cover gasket	19
371 486	70505	Gaskets flywheel/gear housing	24
371 487	70506	Gasket flywheel/gear housing	23
371 490	70507	Gasket	35
371 491	70508	Gasket	34
371 492	70314	Gasket seal – engine	36
371 493	70509	Gasket seal – engine	36
371 495	70510	Gasket for steering	57
371 498	70514	Gasket	46
371 499	70515	Manifold gasket	23
371 500 replaced by 1 392 936		Gasket	46
371 502	70518	Gasket seal – engine	36
371 503 (215 242-9)	68593	Oil pan gasket	20
371 505 (170 700-9, 1 459 004)	68592	Oil pan gasket	20
371 507	68532	Gasket seal – engine	36
371 510	70519	Manifold gasket	21
371 612 (1 331 770)	81525	Clutch servo cylinder	47
372 472 (373 472, 346 143)	93725	Cylinder head gasket	14
372 984 (290 534)	3890	O-ring/seal ring – engine	30
372 985	3891	O-ring/seal ring – engine	30
373 472 (372 472, 346 143)	69228	Cylinder head gasket	14
375 086	61649	Oil seal for hubs and wheels	40
375 087	61651	Oil seal for hubs and wheels	39
378 264	70521	Manifold gasket	23
378 299 (344 426)	80777	Valve cover gasket	19
378 480	95648	Oil seal – engine	25
381 083	80590	O-ring/seal ring – engine	30
381 962 replaced by 1 338 019		Brake part front-/rear wheel brake	49
382 361-4	69816	Gasket for oil filter	55
383 917	4143	O-ring/seal ring – engine	30
384 464	68533	Gasket	34
385 022	70524	Gasket flywheel/gear housing	23
385 997 (277 272)	97659	Manifold gasket	22
385 998	95844	Manifold gasket	22
386 901	70525	Oil seal	45
386 967	70527	Oil seals front and rear axle, steering	58
387 503	36494	Cylinder head gasket	14
388 422	70529	Gasket	34
388 528 (314 063-9)	81462	Oil seal/gearbox	48
388 728 (124 268)		Oil seals front and rear axle, steering	59

OEM-no.	dph-no.	description	page
391 766	80215	Gasket	34
392 088	98026	O-ring/seal ring – engine	30
392 309 (298 021)	80851	O-ring/hubs and wheels	41
392 652	93835	O-ring/seal ring – engine	31
392 653	94357	O-ring/seal ring – engine	32
393 820	68534	Manifold gasket	22
550 422	81723	Repair kit clutch servo	47
550 453	81463	Repair kit clutch servo	47
550 455/6	81724	Repair kit clutch servo	47
550 469 (551 363)	111587	Cylinder head gasket set	15
550 720 (345 362)	81092	Clutch servo cylinder	47
551 350	104472	Cylinder head gasket set	15
551 356	111287	Full set	15
551 363	111284	Cylinder head gasket set	15
551 386	111286	Full set	15
551 430	97486	Gasket set complete engine overhaul incl. cylinder liner rings	18
551 446	96430	Oil pan gasket kit	21
551 449	95241	Gasket set complete engine overhaul incl. cylinder liner rings	18
551 451	82873	Oil pan gasket kit	21
551 459	95242	Gasket set complete engine overhaul incl. cylinder liner rings	18
551 466	97485	Oil pan gasket kit	21
551 469	82868	Cylinder head gasket set	15
551 470	82869	Gasket set complete engine overhaul incl. cylinder liner rings	18
551 484	95825	Cylinder head gasket set	14
551 512	82872	Cylinder head gasket set	15
551 513	95824	Cylinder head gasket set	15
551 516		Gasket set complete engine overhaul incl. cylinder liner rings	18
551 519	111410	Full set	15
551 519	111410	Gasket set complete engine overhaul incl. cylinder liner rings	18
551 570	111547	Full set	15
804 655	94385	O-ring/seal ring – engine	30
804 660	95693	O-ring/seal ring – engine	31
804 662	93838	O-ring/gearbox control	48
804 664	95695	O-ring/seal ring – engine	31
804 666	98262	O-ring/seal ring – engine	31
804 674	97292	O-ring/seal ring – engine	31
804 710	95991	O-ring/seal ring – engine	31
804 713	97291	O-ring/seal ring – engine	31
810 958	95694	O-ring/seal ring – engine	31
810 970	3892	Brake part front-/rear wheel brake	49
810 983	81720	O-ring/gearbox control	48
811 038	70532	O-ring/seal ring – engine	32
811 045	81721	O-ring/front axle	57
811 926	32997	O-ring/seal ring – engine	31
811 942	93594	O-ring/seal ring – engine	32
812 411	70533	Washer – engine	28
812 412	70534	Washer – engine	27
812 413	70535	Washer – engine	28
812 414	70536	Washer – engine	28
812 415	70537	Washer – engine	27
812 416	70316	Washer – engine	28
812 417	70538	Washer – engine	28
812 418	70539	Washer – engine	28
812 419	70540	Washer – engine	29
812 420	70317	Washer – engine	29

OEM-no.	dph-no.	description	page
812 421	70541	Washer – engine	29
812 423	70543	Washer – engine	29
812 424	70544	Washer – engine	28
812 425	70545	Washer – engine	29
812 426	70546	Washer – engine	29
837 613	70547	Oil seal – engine	25
CLS662S	94523	Cylinder liner sealing ring kit	16
CLS827S	48191	Cylinder liner sealing ring kit	16
CLS828S	50827	Cylinder liner sealing ring kit	16
CLS934S	61340	Cylinder liner sealing ring kit	17
DS11/DSC11	98210	Cylinder liner sealing ring kit	17
DS14 8Zyl	95099	Cylinder liner sealing ring kit	17
DS9 6Zyl	95100	Cylinder liner sealing ring kit	16

Engine gaskets and gasket sets



Cylinder head gasket

dph-no.	OEM-no.	application
36494	387 503 346 216 291 159 1 403 258	DN9, DS9, DSC9 6 cyl. from 1984 G, P82, F, G P, R, T92/93, K93
93725 69228 69286	372 472/ 373 472/ 346 143	D11, DS11 – 6 cyl. 1975.1979 L, LB, LS, LT, LBS, LBT111 DN11 up to motor 5258563 from 1980, 6 cyl., G, B, R, T112 DS11 up to motor 5307928SSS from 1980, 6 cyl., G, B, R, T112/113 DSC11 up to motor 40701045N from 1980, G, B, R, T112/113
70438	1 313 459 1 403 587	D14, DS14, DSC14 8 cyl. up to 1979 L, LB, LS, LBS140/141, LBT141 LT146, B, CR145 from 1980 DS14, DSC14 R, T142/143
104473	1 444 941/ 1 403 260 1 377 039	DSC12 application Scania 124 up to engine 6119599

Cylinder head gasket set

dph-no.	OEM-no.	application
95825	551 484	DN9, DS9, DSC9 6 cyl. Dia 115 1984- G82, P82, G92, P92, R92, T92, P92HK, F92 H, K92, G93, P93, P93HK, P93MK, R93, T93, T93HK, F93 H, K93

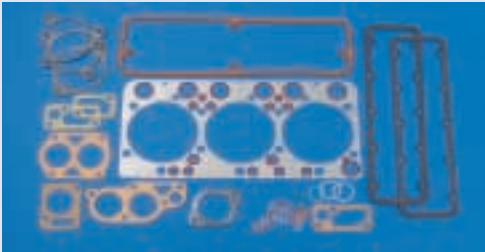
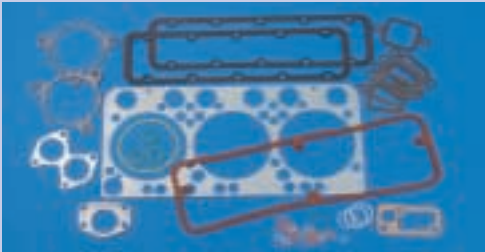
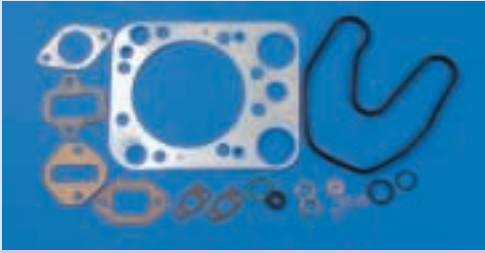
Cylinder head gasket set

dph-no.	OEM-no.	application
95824	551 513	 <p>D11, DS11 1975-1979 6 cylinder L, LB, LS, LT, LS, LBT111 DN11 from 1980 up to motor 5258563, G, P, R, T112 DS11 6 cylinder from 1980 up to motor 5307928SSS, G, P, R, T112 DSC11 6 cylinder from 1980 up to motor 40701045N, G, P, R, T112</p>
82872	551 512	 <p>DS11, DSC11 Mot. 5307929 SSS, Mot. 4070105 SN, 6 cyl. Dia 127 P113, P113 HK, R113, R113 HK, T113, K113 CLB, K113 CLP, K113, TLB, K113 TLP</p>
82868	551 469	 <p>DS14, 8 cyl. Dia 127 1975 – 1979 L, LS, LB, LBS140, L, LS141, LB, LBS, LBT141, LT146 D14, CR, BR145 DS14, DSC14, 1980-, 8 cyl. Dia 127 R142 1981-1988, T142 1980-1988 R143 1988-, R143 HK1990-, T143 1988-</p>
104472	551 350	 <p>DSC12 application Scania 124 up to engine 6119599</p>
111587 111284	550 469 551 363	 <p>DC 11 DC 12 DSC 12 DT 12</p>

Full set

dph-no.	OEM-no.	application
111287	551 356	DC 11 up to engine 6119599 8004779
111286	551 386	DC 11 up to engine 6119599 8004779
111410	551 519	DS11, DSC11 up to engine 5307929 until year 12/1987
111547	551 570	

Cylinder liner sealing ring kit

dph-no.	OEM-no.	application
94523	CLS662S	<p>DS8, D8, Contents: 3x 323 662 installation paste 6 cylinder dia. 115, 1975- L, LS, LB80, LBS85, LB80H, L, LB81, L, LS, LB LBS86</p> <p>DN8, DS8, DS18 6 cylinder dia. 115, G82, P82 1981-, T82 1980-</p>
48191	CLS827S	<p>DN9, DS9, DSC9 Contents: 2 o-rings 323 662 1 sealing ring 1302827 installation paste</p>
95100	DS9 6Zyl	<p>DS9, DN9, DSC9 Contents: 6x1 302 827 12x 323 662 6 cylinder dia. 115 1984- G82, P82, G92, P92, R92, T92, P92HK, F92H, K92, G93, P93, P93HK, P93MK, R93, T93, T93HK, F93H, K93</p>
50827	CLS828S	<p>DN11, DS11, DSC11, DS11, DTC11 Late version with 2 o-rings and 1 sealing ring</p> <p>D14, DS14, DSC14, DS14 Contents: 2 o-rings 1312934 1 sealing ring 1302828 installation paste</p>
94742	127mm	DS11
111269	1 312 934	D11, DS11, DS14
50826		DS 11

Cylinder liner sealing ring kit

dph-no.	OEM-no.	application
95842		DS 8 
61340	CLS934S	D11, DN11, DS11, DSC11, DSI11, DTC11 Early version with 3 o-rings Contents: 3 o-rings 1312934 installation paste 
95099	DS14 8Zyl	DS14 Contents: 16x 1 312 934, 8x 1 302 828, 8 cylinder/dia 127, 1975-1979 L, LS, LB, LBS140, L, LS141, LB, LBS, LBT141, LT146 D14, CR, BR145 DS14/DSC14 8 cylinder/dia 127, 1981-1988 R142, 1980-1988 T142, 1988- R143, 1990- R143 HK, 1988- T143 
98210	DS11/DSC11	DS11/DSC11 Contents: 3x 1 312 934 1x 148,10x153,7x 0,3 FL 

Cylinder liner sealing ring

dph-no.	OEM-no.	application
4212 32970	1 312 934/ 323 641/ 177 587	D11, DS11, DS14 Size: 140x4 green FPM 
36769 36090	1 302 828 (170 951) 342 989	D 14, DS 14, DSC 14 DS 11 DSC 11 8 pcs.required 
32971	323 662 323 661	Size: 128x4 green FPM D 8 DS 8 DS 9 DSC 9 DSI 8 18 pcs.required 







Gasket set complete engine overhaul incl. cylinder liner rings

dph-no.	OEM-no.	application
95242	551 459 551 516	 <p>DN11 up to motor 5258563 DS11 up to motor 5307928SSS DSC11 up to motor 4070105SN 6 cylinder, from 1980 G, P, R, T112</p>
95241	551 449	 <p>DN9, DS9, DSC9 6 cylinder, from 1984 G, P, 82 F, G, P, R, T92/93, K93</p>
82869	551 470	 <p>DS14, DSC14 8 cylinder, from 1980 R, T142/143</p>
97486	551 430	 <p>D11, DS11 6 cyl. Dia 127 1975-1979 L, LB, LS, LT, LBS, LBT111</p>
111410	551 519	 <p>DS11 DSC11 from engine 5307929 until year 12/1987</p>

Valve cover gasket

dph-no.	OEM-no.	application
61109	258 459-7 131 039	 <p>D11, DS11 6 cyl. Dia 127, 1974 L, LS, LT, LB, LBS110 1975-1979 L, LS, LT111, LB, LBS, LBT111 DN11, DS11, DSC11 up to motor 5258563 DS, DSC11 up to motor 5307928 SSS, G112, P112 1980-1987 R112 1981-, T112 1980- -1973 L76, L, LS, LB, LBS110</p>
94530 32906	1 305 959/ 170 610	 <p>D14, DS14, DSC14, DS114</p>

Valve cover gasket

dph-no.	OEM-no.		application
80777 22995	378 299/ 344 426		DN9, DS9, DSC9 6 cylinder dia 115
70476	258 458 131 571		DN8, DS8, DSI8, D8 6 cylinder dia 115
70504	371 483		
104470	1 367 027		DSC12 Diesel Lower gasket up to engine 6119599
104471	1 367 028		DSC12 Diesel Upper gasket up to engine 6119599
110342	1 401 984		DSC 12 Upper gasket up to engine 6119599

Valve cover gasket

dph-no.	OEM-no.	application
109728	1 411 851	Upper gasket DC11 DC12 DT12
109729	1 414 422	Upper gasket DSC12
109730	1 476 506 1 401 982	Lower gasket DC11 DC12 DSC12 DT12

Oil pan gasket

dph-no.	OEM-no.	application
68593 80016	371 503/ 215 242-9	DN11, DS11, DSC11, D11, DS11
68592	371 505/ 170 700-9 1 459 004	DS14, DSC14
70494	366 539 1 412 666	DN9, DS9, DSC9
111447	1 460 359	DC11 DC12 DSC12 DT12

Oil pan gasket kit

dph-no.	OEM-no.	application
96430	551 446	D8, DS8, DN8, DS18 6 cylinder dia 115
97485	551 466	D11, DS11, DSC11
82873	551 451	DN9, DS9, DSC9

Manifold gasket

dph-no.	OEM-no.	application
70519	371 510	D14, DS14, DSC14 L, LB, LS, LBS14/141 LBT141, LT146, BR, CR145 R, T142/143
70503	369 276	DS14 L, LS, LB, LBS140, L, LS141, LB, LBS, LBT141, LT146 D14 CR, BR145 1975-1979, 8 cylinder, 14190 ccm Exhaust manifold 8 pcs required
70489	364 791	DN9, DS9, DSC9 G, P82 F, G, P, R, T92/93, K93 G, P82 F, G, P, R, T, 92/93, K93
70490	364 792	DN9, DS9, DSC9 G, P82 F, G, P, R, T92/93, K93 G, P82 F,G,P,R,T, 92/93, K93

Manifold gasket

dph-no.	OEM-no.	application
70496	366 547	<p>DN9, DS9, DSC9 G, P82 F, G, P, R, T92/93, K93 G, P82 F, G, P, R, T, 92/93, K93 INTAKE</p>
70435	1 301 628	<p>DS11, DSC11 6 cylinder from 1980 from motor 5307929SSS from motor 4070105SN K, P, R, T113</p>
70436	1 301 629	<p>DS11, DSC11 6 cylinder from 1980 from motor 5307929SSS from motor 4070105SN K, P, R, T113</p>
70434	1 109 288 318 415	<p>1,4 mm thickness application: right T113, R113 DS 11, DSC 11 from engine 5307929 EXHAUST</p>
97659	385 997/ 277 272	<p>D11, DN 11 DN 8 DS 11 EXHAUST</p>
95844 70479	385 998/ 277 273	<p>DS-DS11, DN11, DSC11 6 cylinder, L76, L, LB, LS, LBS110, up to year –1974 L, LB, LS, LT, LBS, LBT111 year 1975-1979, G, P, R, T112 up to motor 5258563 – DN11 up to motor 5307928SSS – DS11 up to motor 4070104SN – DSC11 from year 1980 EXHAUST</p>
68534	393 820 1 384 552	<p>INTAKE DN-DS-DS11</p>

Manifold gasket

dph-no.	OEM-no.	application
68531	357 363	INTAKE DN-DS-DSC11
70521	378 264	DS11, 6 cylinder DS11: from motor: 5307929SSS DSC11: from motor: 4070105SN K, P, R, T113, year 1980- EXHAUST
70515	371 499	
111568	1 516 474 1 516 145 1 404 306 1 374 340 1 374 338	INTAKE DC 11 DC 12 DSC 12 DT 12

Gasket flywheel/gear housing

dph-no.	OEM-no.	application
70506	371 487	Fly wheel housing; T112/113, G-P-R112; P-R113
70432	1 101 276	Gear housing DN-DS DSI-DSC11
70524	385 022	Gear housing DN-DS-DSI-DSC11

Gaskets flywheel/gear housing

dph-no.	OEM-no.	application
70505	371 486/ 1 388 683	

Engine parts, fuel, exhaust and cooling system parts

Oil seal – engine



dph-no.	OEM-no.	application
70457	170 761	Size: 25x47x10 NBR A blue L, LS, LT, LB, LBS, LBT140/141; T142/143; R142 (M, H, E)/143
82871	1 109 869	Size: 30x47x10/7 ACM ASW WD DS14, DSC14, DSC14
95648	378 480	Size: 70x85x8 NBR BS WD blue
82323	132 672	Size: 35x58x10 NBR A D10, D11, DS11 L75, L76LS, LKS101
84537	310 951/ 1 109 870	Size: 35x62x7 ACM ASW F WD injection pump K-92/112 N-112, P-82/92/93/112/113 R-92/112/113/142/143, T-82/92/112/142
70547	837 613	Size: 22x32x8 NBR AS

Oil seal – engine

dph-no.	OEM-no.	application
95457	1 345 278	Size: 44,45x60x7 BS SP NBR blue
95458	1 349 089	Size: 38,1x50x6,8 NBR AS W SP blue
70450	139 023	Size: 30x47x10 NBR A D10, D11, DS11 8 cyl.: LK, LKS, LKT141 Water pump
70451	14 107	Size: 50x70x10 NBR A
70455	170 226	Size: 42x72x8 ACM AS WD D10, D11, DS11 8 cyl.: R142, LK, LKS, LKT141
70465	192 600	Size: 25x35x7 AS NBR blue D10, D11, DS11 8 cyl R112 (112M, H, E), T112 (112M/H/E) Injection pump
95850	210 648	Size: 17x28x7 NBR AS
81457	202 288	Size: 42x62x6 AS W blue
84543	280 759	Size: 30x42x6/6,8 BABSL WD NBR blue DN11, DS11, DSC11 6L: G112, P112, R112, T112 `80-> DS9 6L: G93, P93, R93 4x2; 6x2, 6x4 `86-> DS11, DSC11: K113 CLB Bus `91-> DS14 V8: L141, LB141, LS141; LBS141, LBT141, R142, T142 `80->, R143LR4x2; 6x2-6x2/4; 8x2, 8x4 `88-> DS11, DSC11 6L: P113, R113 4x2, 6x2, 6x4 `88-> Injection pump

● Washer – engine



dph-no.	OEM-no.	application
70460 70534	178 562 812 412	Size: 10x13,5x1 CU
70463	182 524	Size: 24x29x2 CU
70466 70482	192 633 303 098	Size: 14x20x1,5 CU
70464	192 081	Size: 12x15,5x1,5 ALU
70467 70537	192 651 812 415	Size: 16x20x1,5 CU
70468	192 820-9	Size: 6x10x1 CU
70469	204 466	Size: 10x14x1 CU

Washer – engine

dph-no.	OEM-no.	application
70471	209 770	Size: 12x15,5x1,5 CU
70535	812 413	
70472	211 077	Size: 5x9x1 CU
70487	330 323	Size: 6x12x1 CU
70488	35 528	Size: 8x12x1 ALU
98692	353 173	(screw, oil level)
70544	812 424	DS-DSI-DSC14
		Size: 36x42x2 AL U
70491	365 375	Size: 20x26x1,5 CU
70533	812 411	Size: 8x11,5x1 CU
70470	209 261	
70536	812 414	Size: 14x18x1,5 CU
70316	812 416	Size: 18x22x1,5 CU
70538	812 417	Size: 20x24x1,5 CU
70539	812 418	Size: 22x27x1,5 CU

● Washer – engine

dph-no.	OEM-no.	application
70540	812 419	Size: 24x29x2 CU
70317	812 420	Size: 26x31x2 CU
70545	812 425	Size: 38x44x2 CU
70454	165 507	Size: 17 x 22 x 1,5 CU
70541	812 421	Size: 28 x 33 x 2 CU
70543	812 423	Size: 32 x 38 x 2 CU
70546	812 426	Size: 45 x 52 x 2 CU

O-ring/seal ring – engine

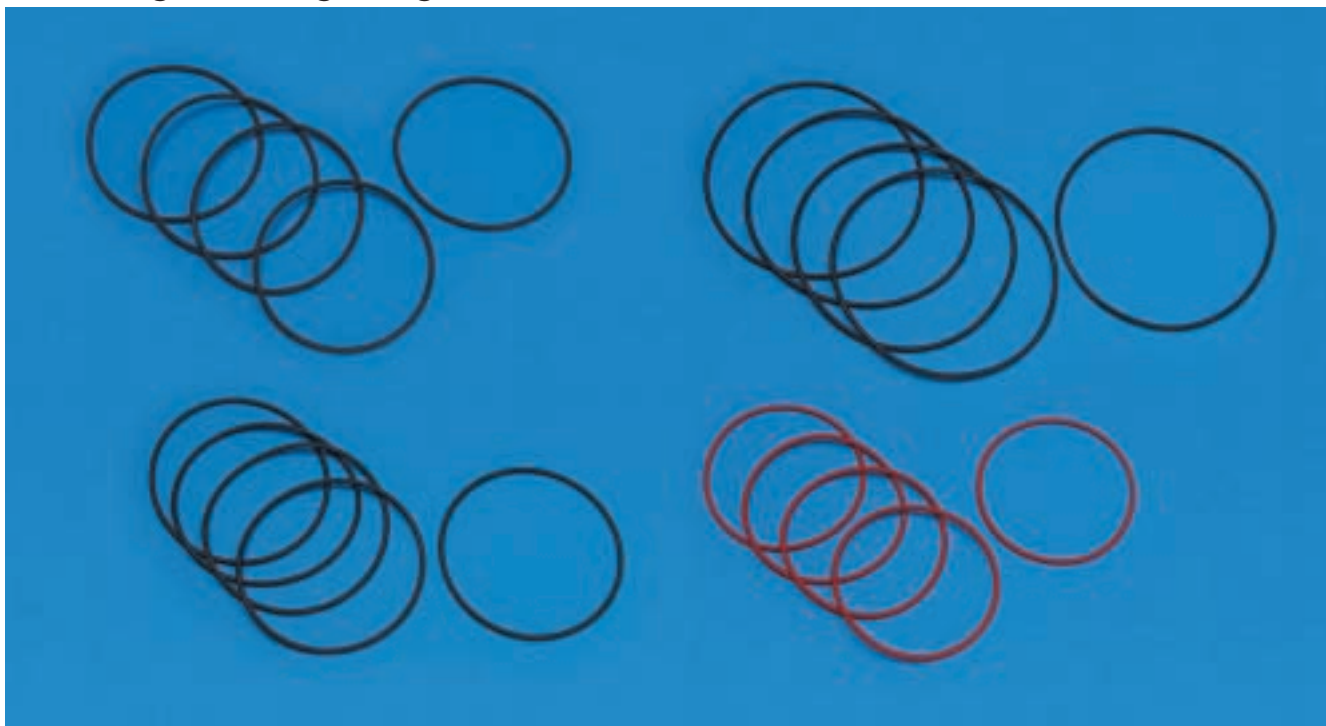

dph-no.	OEM-no.	application
69231	323 451	Size: 98,02x3,53 FPM LB82, LB-LBS86, LLS-LT111, LB-LBS-LBT111, T112/113, G-P-R92/93, G-P-R112, P-R113
3891	372 985	Size: 132,94x3,53 DN-DS-DS18 DN-DS9 DN-DS-DSI-DSC11 DS-DSI-DSC14
3890 34620	372 984/ 290 534	Size: 111x3,5 NBR DN-DS-DS18, DN-DS9 DN-DS-DSI-DSC11 DS-DSI-DSC14 For oil filter housing
80590	381 083	Size: 48x6 NBR
4143	383 917	Size: 11x4 NBR For injection
98026	392 088	Size: 12x2 NBR
94385	804 655	Size: 9,3x2,4 FPM Model 94C Motorcode DCC9.12 For valve lid screw

O-ring/seal ring – engine

dph-no.	OEM-no.	application
95693	804 660	Size: 19x3 NBR
95695	804 664	Size: 29x3 NBR
97291	804 713	Size: 70x3 NBR
95694	810 958	Size: 11,3x2,4 NBR
93835	392 652	Size: 90x3 MVQ red (intake manifold) T92/112/142/113/143, G-PR92/112/93, P-R113, R143
80236	1 107 097	Size: 29,1x1,6 FPM green
80411	1 107 098	Size: 45,8x1,6 FPM green
98262	804 666	Size: 21x3 NBR
97292	804 674	Size: 59,2x5,7 NBR
95991	804 710	Size: 54,5x3 NBR
32997	811 926	Size: 26,2x3 NBR

O-ring/seal ring – engine

dph-no.	OEM-no.	application
93594	811 942	Size: 60x3 FPM
70532	811 038	Size: 49,5x3
94357	392 653	Size: 22,1x1,6 MVQ
80404	1 302 243	Size: 108x3 MVQ
98260	1 303 789	Size: 34,2x3 NBR
98261	1 315 437	Size: 22x28x5 type 43
97290	1 334 294	O-ring kit 4x19,10x1,6 NBR 1x12,10x1,6 NBR 2x8,13x1,78 NBR
98264	1 349 018	Size: 99,2x5,7 FPM green
32999	174 229	Size: 79,5x3 FPM
81970	276 587	Size: 100x6,5 NBR
97479	321 992	Size: 106x3 FPM

● O-ring/seal ring – engine



dph-no.	OEM-no.	application
93836	211 813	Size: 107,54x3,53 NBR
80746	321 991	Size: 99,5x3 FPM green
80747	349 353	Size: 79,2x5,7 FPM green
80408	361 523	Size: 59,2x5,7 MVQ
80406	361 526	Size: 94,1x5,7 MVQ
34432	362 128	Size: 114,5x3 MVQ
94386	362 129	Size: 149,2x5,7 MVQ
93808	1 380 834	Size: 252x6 FPM
84526	257 737	Gasket

● O-ring kit – engine

dph-no.	OEM-no.	application
111565	1 422 564 1 398 810	DC 16 1 pc. 34x3 FPM purple 1 pc. 24,3x2,4 NBR blue 1 pc. 32x2,5 NBR

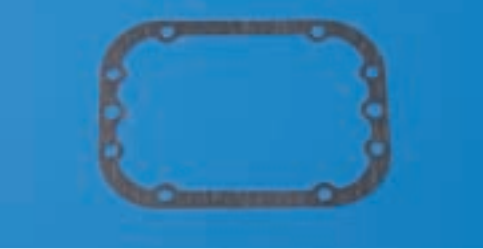

Gasket

dph-no.	OEM-no.	application
68533	384 464	
97850	1 302 556	
36768	1 302 827	6 pcs required DN9, DS9, DSC9 6 cylinder, from 1984 G82, P82, G92, P92, R92, T92, P92HK, F92H, K92, G93, P93, P93HK, P93MK, R93, T93, T93HK, F93H, K93
70508	371 491	(filling flange) DN-DS-DSI-DSC11 DS-DSI-DSC14
80215	391 766	
84528	1 305 595	Size: 18,6x1,9 FPM
70529	388 422	

Gasket

dph-no.	OEM-no.	application
70507	371 490	DN-DS9 DN-DS-DSI-DSC11 DS-DSI14
70443	1 350 378	
70444	1 350 379	
70445	1 350 380	
70501	366 557	

Gasket seal – engine

dph-no.	OEM-no.	application
70502	369 229	





Gasket seal – engine

dph-no.	OEM-no.	application
70314	371 492	Application: oil cooler
70509	371 493	
70518	371 502	
68532	371 507	
95868	315 270	V-ring NBR A50 V-45
95647	317 916	U-ring type 90 16x22x6
84529	1 305 596	







● Gasket seal – engine

dph-no.	OEM-no.	application
84530	1 305 597	
97849	1 305 673	
84527	332 448	
4147	348 339	
34434	230 297	Material: rubber 
104348	1 304 293	
111443	1 374 326	

Gasket seal – engine

dph-no.	OEM-no.	application
111445	1 374 327	
111442	1 374 334	
111446	1 374 344 1 541 633	Water pump DC 11 DC 12 DSC 12 DT 12
111444	1 375 383	Oil cooler
95969	1 388 678	
111440	1 403 129	Oil pump
111231	1 675 602	
111441	1 423 290 1 384 004	

Oil seal for hubs and wheels

dph-no.	OEM-no.		application
61645	300 278		Front axle AM55/60 Size: 110x140x12/21 NBR special K-92/112 N-112 P-82/92/93/112/113 R-92/112/113/142/143 T-82/92/112/142
61651	375 087		AM56 Size: 110x140x15 NBR ASW spezial
34423	173 320		AS60, ASA60/70 Size: 117,47x142,87x12,7 NBR A blue K-92/112 N-112 P-82/92/93/112/113 R-92/112/113/142/143 T-82/92/112/142
70447	121 257		RP652, R653 Size: 136,52x161,92x12,7 NBR A
98517	309 113		Reductor hub Size: 161,92x187,32x12,7 NBR A K-92/112 N-112 P-82/92/93/112/113 R-92/112/113/142/143 T-82/92/112/142
50177	370 076		Rear axle AD/AS90, AD85 Size: 145x170x15/20 NBR B spezial K-92/112 N-112 P-82/92/93/112/113 R-92/112/113/142/143 T-82/92/112/142
34422	159 496		AD90 (brake shoe: 203 mm) Size: 150,8x177,8x12,7 NBR AS blue

Oil seal for hubs and wheels

dph-no.	OEM-no.	application
50176	370 075	AD100 shaft RB/RBP803 Size: 155x180x24/29 FPM B spezial K-92/112 N-112 P-82/92/93/112/113 R-92/112/113/142/143 T-82/92/112/142
61641	120 310	AD/AS90 Rubber cork Size: 158x170x5,3
61649	375 086	AM56/61/70 Size: 125x160x15 NBR AS W

Oil seal – crankshaft

dph-no.	OEM-no.	application
111452 111453	1 375 002 1 433 183	Size: 145 x 175 x 13 special Crankshaft rear DC 11 DC 12 DT 12
111285	369 477	Size: 80 x 100 x 13 special
111272	369 478	Size: 130 x 160 x 15 FPM AW/BS LD Crankshaft rear DS9 DS11, DN11, DSC11 DS14 DSC14

● O-ring/hubs and wheels

dph-no.	OEM-no.	application
80851	392 309/ 298 021	AD100 Size: 249,2x5,7 T142, R142, T93/113/143, G-P-R93, P-R113, R143



● Repair kit/compressor (engine)

dph-no.	OEM-no.	application
81677	1 108 223	Compressor 15,5 W
81716	278 198	Compressor 15,5 W
82835	1 103 236	Compressor 15,5 W

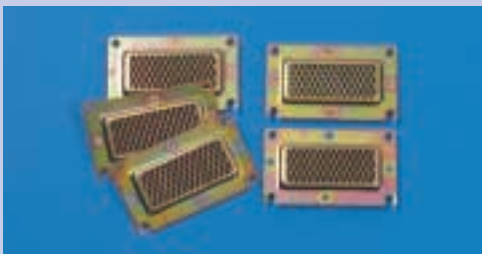

● Repair kit

dph-no.	OEM-no.	application
81715/ 82817	1 108 228/ 300 162	15,5 compressor Bendix
82836	1 327 886	15,5 compressor Bendix



Repair kit

dph-no.	OEM-no.	application
82837	141 964	Bendix Tuflo 500
81725	229 373	Inlet exhaust valve kit
81714	282 501	Trailer control valve kit
81717	282 799	D2 governor kit
70814	309 164-2	For same type as 272 760-0
81718	313 004	Hand control valve kit

Repair kit

dph-no.	OEM-no.	application
81719	319 477	Trailer dump valve kit
82816	293 546	



Cylinder liner shim

dph-no.	OEM-no.	application
33008	1 114 036	DS11/DSC1101 For cylinder liner 1114035 Late production



O-ring/fuel system

dph-no.	OEM-no.	application
93837	242 857	Size: 60x4 NBR All models
98656	252 496	Size: 14x18x1,5 CU All models
98658	192 871	Size: 16x20x1 CU All models



● O-ring/fuel system

dph-no.	OEM-no.	application
21255	170 424	Size: 9,6x19,7x2 CU All models



● Seal ring/cooling system

dph-no.	OEM-no.	application
32990	170 205	For: Thermostat Scania 251 899 and 255 502
70315	291 826	L-LS-IT111, LB-LBS-LBT111, T112/113, G-P-R112, P-R113



Rubber cushions for engine, exhaust systems and gearbox

Oil seal

dph-no.	OEM-no.	application
70525	386 901	 <p>Transmission, mechanical Size: 85x105x13 NBR BS blue</p>
70484	32 201	 <p>Transmission, mechanical Size: 35x52x10 NBR A</p>
70475	254 635	 <p>Transmission, mechanical Size: 25x35x7 NBR B dph</p>
96716	1 318 388	 <p>Input gearbox Size: 55x75x9 FPM BS RD Engine DS11, DSC11: K113 CLB Bus '91-> Engine DSC14 V8: R143L-R4x2, 6x2-6x2/4; 8x2, 6x4; 8x4 '88->, 144L '95-> DSC12: 124C'96-> DSC9: 94G '96-></p>
84541	294 275	 <p>Size: 75x90x10/11 blue DSC12: 124C '96->, DCS14: 144L '95-> DSC9: 94G '96-> DSC9 6L: G93, P93, R93 6x4 '86->, G82, P82 '86-> DN11, DS11, DSC11 6L: G112, 112, R112, T112 '80->, P113, R113 4x2; 6x2, 6x4 '88-> DS14 V8: L141, LB141, LS141, LBS141; LBT141, R142, T142 '80-> R143L-R, 4x2; 6x2-6x2/4, 8x2 '88-></p>
81460	329 638	 <p>Size: 25x35x7 BABSL NBR For gearshift shaft</p>

Gasket

dph-no.	OEM-no.	application
70495	366 546	
70514	371 498	
96313	1 392 936/ 371 500	Application: water pump
97851/ 97852	1 305 139/ 1 329 585	
70442	1 320 298	

Clutch, gearbox

Clutch servo cylinder

dph-no.	OEM-no.	application
81422/ 81092	345 362/ 550 720	(Wabco); GR871 (no. 6337157-6339120), interchangeable with Scania 371 612 T112/T113/T142/T143; G-P-R112; R142, P-R113, R143
81524	360 717	T82, T92, T112; G-P82, G-P-R92/112
81525 81803	371 612/ 1 331 770	T82, T92, T93, T112, T113, T140; G-P82, G-P-R92/93/112; P-R113, R143

Repair kit clutch servo

dph-no.	OEM-no.	application
81723	550 422	For: 360 717 (old version)
81463	550 453	For: 360 717 (new version)
81724 51926	550 455/6/ 1 336 159	For: 371 612

O-ring/gearbox control

dph-no.	OEM-no.	application
32996	244 446	For: control cylinder 284 015 All models Size: 41,2x3 NBR
93838	804 662	For: control cylinder 284 015 T82/92/93/112/113/142/143, G-P82, G-P-R92/92/112, P-R113, R142/143 Size: 24x3 NBR
96197	194 414	Size: 199,3x3 NBR For gearbox G770, GS770, GH774, GS771, GS772, GR871, GR-E871, GR-H880
81720	810 983	For: control cylinder 284 015 All models Size: 79,2x5,7 NBR

Oil seal/gearbox

dph-no.	OEM-no.	application
81462	388 528/	Size: 45x65x10/8 FPM A/BS LD
70483	314 063-9	Size: 45x65x9 ACM BS RD LA For gearbox G770, GS770, GH774, GS771, GS772, GR871, GR-E871, GR-H880

Brake parts

Brake part front-/rear wheel brake

dph-no.	OEM-no.	application
3892	810 970	 <p>Size: 33x3 NBR, all models, Quantity required: 8 L/LB, 80H, L/LB81, 81H, F/G/K/P/S/T82, BR/CR/L/LBS/LS85, 85H, B/BF/BR/L/LB/LBS/LS86, F/G/K/P/R/T92, F/G/K/R/P/T93, BR/CR/L/LB/LBS/LB/LS/LT110, 110H, B/BF/BR/CR/L/LB/LBS/LBT/LK/LKT/LS/LT111, 111H, SBA/SBAT111, BF/BR/CN/F/G/K/MTR/N/P/R/S/T112, BN/CN/F/K/L/N/P/R/T113, BR116, L/LB/LBS/LBT/LS140, 140H, L/LB/LBS/LBT/LKT/LS141, 141H, R/T142, R/T143, BR/CR/LT145, LT146</p>
3889	182 930	 <p>Size: 31x4,5 NBR, all models, Quantity required: 8 L/LB, 80H, L/LB81, 81H, F/G/K/P/S/T82, BR/CR/L/LBS/LS85, 85H, B/BF/BR/L/LB/LBS/LS86, F/G/K/P/R/T92, F/G/K/R/P/T93, BR/CR/L/LB/LBS/LB/LS/LT110, 110H, B/BF/BR/CR/L/LB/LBS/LBT/LK/LKT/LS/LT111, 111H, SBA/SBAT111, BF/BR/CN/F/G/K/MTR/N/P/R/S/T112, BN/CN/F/K/L/N/P/R/T113, BR116, L/LB/LBS/LBT/LS140, 140H, L/LB/LBS/LBT/LKT/LS141, 141H, R/T142, R/T143, BR/CR/LT145, LT146</p>
69284	123 102	 <p>Size: 38x50x7 NBR A all models Quantity required: 4</p>
68810	120 828	 <p>Size: 45x60x7 NBR A blue all models Quantity required: 4</p>
34425	214 008	 <p>Size: 90x110x14 BS NBR blue Differential, assembly K-92/112 N-112 P-82/92/93/112/113 R-92/112/113/142/143 T-82/92/112/142</p>
69230	1 338 019/ 381 962	 <p>Size: 31x4,5 MVQ G93, P93, R93, T93 K93CLB from chassis no. 1820107-, K113TLA from chassis no. 1820107-, N113CLL/CRL, N113ALLB/CLB/CRB/DRB from chassis no. 1820118-, L113TRB, P113, R113, T113, R143, T143</p>

● Brake part/front-/rear wheel brake

dph-no.	OEM-no.	application
104111	1 338 018/ 1 307 340	For brake shoe roller 154259 Size: 32,5x3 mm



● Valve lifter

dph-no.	OEM-no.	application
51307	1 116 635/ 1 103 422	D8, DN8, DS8, DSi8, D11, DN11, DS11, DSC11, DSi11, DTC1101, D14, DS14, DSC14, DSi14 P113, R113, T113, R143



● Valve guide

dph-no.	OEM-no.	application
61147	300957	INTAKE DS8/DSi8 late production, DN9, DS9, DSC9, D11, DN11, DS11, DSC11, DSi11, D14, DS14, DSC14 Not for cyl. heads ref. 300612-7, 397775-8 Not for engines with catalytic converter
61148	300958	EXHAUST D8, DN8, DS8, DSi8, DN9, DSC9, D11, DN11, DS11, DSC11, DSi11, D14, DS14, DSC14 Not for cyl heads ref. 300612-7, 397775-8 Not for engines with catalytic converter



● Valve intake

dph-no.	OEM-no.	application
61144	272 804	INTAKE DS11, L-LS-LT111, LB-LBS-LBT111
93994	270 247	INTAKE DS-DSi14, L-LS141, LT146, LB-LBS-LBT141



Valve intake

dph-no.	OEM-no.	application
98678	294 674/ 136 083-6	INTAKE DS11-turbo, DN14, DCS14-turbo
93995	215 715	INTAKE Engine D420
98681	272 803/ 1 361 189	INTAKE D10
98679	1 319 081	INTAKE DS9-turbo, DSC9-turbo
110771	1 360 836	INTAKE
110773	1 361 190	INTAKE

Valve exhaust

dph-no.	OEM-no.	application
61145	232 018	EXHAUST DN-DS-DSI-DSC11 DS-DSI14 (- motor 5530537)
98680	366 256/ 1 360 833	EXHAUST DS9-turbo, DSC9-turbo
110772	1 361 195	EXHAUST DS9-turbo, DSC9-turbo
98682	243 477/ 1 361 197	EXHAUST D10, DN14
98683	352 347/ 1 360 834	EXHAUST DCS14-turbo
93996	168 843/ 136 119-5	EXHAUST Engine D440

Valve seal ring

dph-no.	OEM-no.	application
93997	17 115	Engine D420 5650 ccm 66 kW (90 PS)

● Valve seal ring

dph-no.	OEM-no.	application
93998	17 543	 <p>Engine D440 6230 ccm 73 kW (100 PS)</p>
61149	289 517	 <p>INTAKE DN11/DS11/DSC11 engine no. 5220094-, DS14/DSC14/DSI14 engine no. 5504736-</p>
61151	242 672	 <p>EXHAUST D11/DN11/DS11/DSC11 engine no. -3075634, - 4070104-. 5307760-, DS14/DSC14/DSI14 engine no. -5530537 Not for cylinder head ref. 163588</p>

● Repair kit/brake valve

dph-no.	OEM-no.	application
81682	319 475	 <p>For: Scania 290 013</p>
82819	313 114	 <p>For: Scania 290020 foot brake valve = G-P-82, G-P-R92, 112, R142, T82/92/112/142 T92/112/142/93/113/143 T92/93/112/113/142/143</p>

Diaphragm/Brake part

dph-no.	OEM-no.	application
69213	203 670	T9, dia 130
69215	171 566	T12, dia 140
69217	160 342	T16, dia 150
69218	151 476	T20, dia 165
69219	143 112	T24, dia 180
69220	143 113	T30, dia 200
69223	143 118	T36, dia 230

● Repair kit air dryer drain valve

dph-no.	OEM-no.	application
82818	309164	For Bendix air dryers



● Gasket for oil filter

dph-no.	OEM-no.	application
69816	382 361-4	For oil filter 382353-1 (not in our range)



● Oil seal

dph-no.	OEM-no.	application
96311	1 345 279	Size: 44,5x58x7,5 SPNBR blue For brake shoe shaft



● Oil seal brake part

dph-no.	OEM-no.	application
109531	1 100 645	Size: 54,1 x 70/74 x 7,5/11 NBR
109530	1 343 372	Size: 45 x 60 x 7 NBR A blau Steering knuckle pin
109529	1 395 999	Size: 56x72x7 NBR SP A Steering knuckle pin
112266	1 409 889	Size: 142 x 170 x 15/16 NBR Wheel hub, inside
112282	1 409 890	Size: 75 x 100 x 10/13 NBR Wheel hub, outside



Oil seal brake part

dph-no.	OEM-no.	application
111330 111372	1 502 384	 <p>Size: 84,93x104,77x18,26 FPM/ACM spezial 85x105x18 FPM SP LD</p>
70486	33 326	 <p>Size: 70 x 100 x 12 A NBR blau</p>
109532	347 468	Size: 56 x 70 x 6 NBR A SP

Front and rear axle parts, steering

O-ring/front axle

dph-no.	OEM-no.	application
94398	182 935	Upper AM55 Size: 49x7 NBR
81721	811 045	Lower AM56/61/70 AM800/820 Size: 84,5x3 NBR

Gasket bogie axle

dph-no.	OEM-no.	application
95869	204 750	Application: bogie axle L, LS, LT110, LB, LBS, LBT140H, L, LS, LT111, LB, LBS, LBT141, T112, T142, G82, P82, G112, P112, R112, R142, T93, G93, R93, T113, P113, R113, T143 2 pcs. required

Gasket for steering

dph-no.	OEM-no.	application
70437	1 305 341	For steering
70510	371 495	(For hydraulic pump 300130/571368)

Oil seals front and rear axle, steering



dph-no.	OEM-no.	application
34421	338 643	DN8, DS8, DS18, DSC8, DN9, DS9, DS19, DSC9 DN11, DS11, DS111, DSC11 DN14, DS14, DS114, DSC14 Size: 80x100x12 FPM BS LA RD Front
70461	178 866	DN11, DS11, DS111, DSC11 DN14, DS14, DS114, DSC14 Size: 130x160x13 NBR B Rear
69285	366 303	DN9, DS9, T92/93/113/142/143; G-P-R92/93, P-R113; R143 Size: 130x160x15 MVQ AS W LD Rear
70527	386 967	Front axle Size: 72x105x13 NBR BS green
70485	32 898	Front Axle AM55 (1 st series) size: 120,65x146,05x12,7 K-92/112, N-112 P-82/92/93/112/113 R-92/112/113/142/143 T-82/92/112/142
3888	33 352	Rear axle AD90 (ext.) size: 75x100x10 NBR A blue K-92/112, N-112 P-82/92/93/112/113 R-92/112/113/142/143 T-82/92/112/142
70481	297 991	Size: 137x161,92x15/12 BS WD SP LA Rear axle

Oil seals front and rear axle, steering

dph-no.	OEM-no.	application
34428	231 938	Size: 130x160x15 MVQ AS W LD Engine, crankshaft rear K-92/112, N-112 P-82/92/93/112/113 R-92/112/113/142/143, T-82/92/112/142
61643	297 999	Size: 115x135x10 A SP blue Rear axle
70449	136 106	Size: 28x38x7 NBR A For steering
70473	211 337/ 216 608	Size: 25x35x8 AD NBR For steering
96111	1 363 673/ 1 303 673/	Rear axle AD85 Size: 145x170x14,5/18 FPM BS special K-92/112, N-112 P-82/92/93/112/113 R-92/112/113/142/143, T-82/92/112/142
70446	120 979/ 227 138/ 304 552	Front/rear axle Size: 80x100x10 A NBR green D10, D11, DS11 L75, L76LS, LKS101, L, LS110, L, LS, LT, LK111, R112 (112M,H,E) B75, B76, B110, B111, BR115, BR116
70452	144 116	Rear axle Size: 30x55x10 NBR A
34426	124 268/ 388 728	Rear axle Size: 80x100x13 BS NBR K-92/112, N-112, P-82/92/93/112/113, R-92/112/113/142/143 T-82/92/112/142 Also for transmission GR870/GR871T
61647	370 074	Size: 137x161, 92x15/20 NBR BS WD SP LA, Rear axle AD80 outer/inner, K-92/112, N-112, P-82/92/93/112/113, R-92/112/113/142/143, T-82/92/112/142 Engine DSC14 144L `95-> Engine DN11, DS11, DSC11 6L: G112; P112; R112; T112 `80->, P113, R113 4x2; 6x2, 6x4 `88-> Engine DS9 6L: G93, P93, R93 4x2; 6x2; 6x4, G92, P82, `86-> Engine D8, DS8 6L: L86, LS86, LB86, LBS/LBT86, L81, LB81 `75-> Engine DS14 V8: R142, T142 `80->, R143L-R, 4x2, 6x2-6x2/4; 8x2, 8x4 `88->
110713	125 766	Size: 70x90x10 A LDNBR L75, L76 LS
98060	1 393 331	Size: 85x105x18 FPM LD SP Steering

Oil seal front and rear axle, steering

dph-no.	OEM-no.	application
82497	1 363 674/ 130 934-2	Size: 158x188x14,5/18 FPM RWDR Kasette Wheel bearing, exterior DSC12: 124C `96->
93428	1 342 363	With Polrad
93430	1 334 535	Size: 125x150x14 NBR AS SO blue
84730	1 335 243	Crankshaft, front Size: 80x100x12 FPM BS LA RD Engine DS11, DSC11, DN11: K113 CLB Bus `91->, P113, R113 4x2; 6x2 `88-> 6L, P113, R113 6x4 `88->, G112, P112, R112, T112 `80-> Engine D11, DS11: L110, LS110, LB110, LBS110 ,74->, L111, LB111, LS111 ,75->, LB111H, LBS111H, LBT111H `77->80, engine D14, DS14: L140, LB140, LS140, LBS140. LT146, R142, T142 `80->, BR145, CR145 Engine D8, DS8, DN8. DS18: L86, LS86, LB86, LBS/LBT86, `75->, L81, LB81, `75->, L81, LB81, LBS85, G82, P82; T82 `80`-> Engine DS14 V8: L141, LB141, LS141, LBS141, LBT141, R143L-R4x2, 6x2-6x2/4; 8x2 `88-> Engine DSC14 V8: R143LR, 6x4; 8x4 `88-> 144L `95->, Engine DS9, DSC9 6L: P92, R92, T92 `86->, G93, P93, R93 4x2; 6x2 `86->, G82, P82 `86->
34427	291 076	Rear axle, interior Size: 145x170x15/20 NBR B spezial Engine DSC12 124C `96-> Engine DSC14 144L `95-> Engine DSC9 94G `96-> Engine DSC9 6L: G93, P93, R93 4x2; 6x2, 6x4, G82, P82 `86->, Engine DN11, DS11, DSC11 6L: G112, P112, R112, T112 `80->, P113, R113 4x2; 6x2; 6x4 `88-> Engine DN8, DS8, DS18 6L: G82, P82, T82 `80-> Engine DS11, DSC11: K113CLB Bus `91-> D8, DS8 6L: L86, LS86,k LB86, LBS/LBT86 `75-> Engine DS14 V8: L141, LB141, LS141, LBS141, LBT141, R142, T142 `80->, R143LR, 6x4; 8x4 `88-> Engine D11LB, DS11 6L: LB111H, LBS111H, LBT111H `77->80

Oil seal rear axle

dph-no.	OEM-no.	application
111548	370 076	 <p>Size: 145 x 170 x 15/12 B special FPM</p>

Oil seal differential bevel pinion

dph-no.	OEM-no.	application
95649	1 383 129	Size: 84,93x104,77x18,26 FPM/ACM SP 1
111330	1 502 384	
98061	1 386 594	Size: 84,93x104,77x18,26 FPM/ACM SP 2

Front and rear suspension parts

● Shackle bushing

dph-no.	OEM-no.		application
70172	135 036		For shackle pins: 355147, 355149 Dia. 46x89, 2 pcs required REAR SPRING
70448	135 698		For shackle pin: 355148 Dia. 46x102, 4 pcs required REAR SPRING

● O-ring for shackle pins

dph-no.	OEM-no.		application
61342	182 929		For shackle pins: 355145, 355146 Dia 23x6,5 mm NBR FRONT SPRING All models
61343	182 931		For shackle pins: 355147, 355148, 355149 Dia 31x6,5 mm NBR REAR SPRING All models

Seal ring/wiper ring for gearbox

dph-no.	OEM-no.	application
81458	315 022	G-GS770, GH774, GR-GRE870/871 Size: 60x80x8,25 rubber/metal
95851	244 448	GS771/772; GR-GRE870/871 Size: 25x35x5/7 T112/R142 transmission

Vibration insulator (motor hood)

dph-no.	OEM-no.	application
81975	329 583	T82/92/112/142/93/113/143

Rubber bushing







dph-no.	OEM-no.	application
82302	137 207/ 332 738	Left & Right
81971	340 895	







Hose

Hose

dph-no.	OEM-no.	application
81973	241 805	

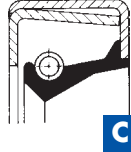
Overview of most popular oil seal types acc to DIN 3760/3761

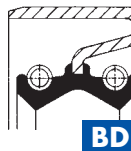
Application	Description
 A	rubber version with single lip
 AS	rubber version with sealing and dust lip
 AD	rubber version with 2 lips and 2 springs
 AW	rubber version with sealing lip and corrugated profile
 ASW	rubber version with sealing lip and dust lip and corrugated profile
 A/B	seal with combined elastomer/metal outer cover

Application	Description
 B	metal cased open
 BS	metal cased open with dust lip
 C	metal cased closed
 CS	metal cased closed with dust lip
 BD	metal cased open with 2 lips
 A/BS	seal with combined elastomer/metal outer cover with dust lip

Abbreviations at „style“

FL Washer
PR Profile seal
OR O-Ring
WR Oil seal

Complimentary definitions

RD Right hand helix
LD Left hand helix
WD Double helix
SF Special design
OF Without spring
V Reinforced seal lip
LA With sealant film
W Corrugated profile
SP Special

Abbreviations at „mat“ (material)

ACM Polyacrill rubber
FPM Fluor rubber (Viton)
MVQ Silicone rubber
NBR Nitril rubber
EPDM Ethylen-Propylen-Dien-rubber
PTFE Polyterafluoren-ethylen
HNBR Hydrogenated NBR
AL Aluminium
CU Copper
FE Iron
FZ Felt

VOLVO

Spare parts for trucks

Qualität - made by
dph Germany



dph[®]

Dichtungspartner Hamburg

Important notes

- 1.** This catalogue replaces all previous issues.
- 2.** The catalogue is protected by copyright.
The duplication of it or any part of it is prohibited.
- 3.** The supply of dph components strictly adhere to our sales and delivery agreement and are subject to our conditions of payment.
- 4.** We reserve the right to modify our components as necessary.
- 5.** The original equipment part numbers, as well as SLP, Elring-No., etc. indicated in the catalogue only serve as a cross-reference comparison with dph numbers. They must not appear on any advice notes or invoices.
- 6.** All original part numbers of engine or vehicle manufacturers in this catalogue are mentioned for comparison reasons only and should not be used in contacts with vehicle owners.
- 7.** Every effort has been made to ensure that the information in this catalogue is correct at the time of printing, but dph cannot accept any responsibility for errors which may occur.

Qualität – made by dph Germany



Dichtungspartner Hamburg

High quality guarantees growing success



We have always supplied our customers with high quality seals for the following sectors: Automobile, hydraulic seals, mountings and other fields all at reasonable prices and quick delivery. We can count many well-known companies throughout the world as satisfied customers.

Four strategies guarantee our success:

- First rate products with top class quality assured
- Short delivery times due to our own stock levels
- Flexibility in the procurement of all parts
- Attractive pricing policy

Fully automated electronic quality checks and manufacturing to DIN standards guarantee continuous high quality products. To your advantage and always at very fair prices.

Perfect manufacturing and continuous quality assurance

Together we are strong – this is the maxim in our group. High quality is not achieved just as a result of monitoring but of production technique. Therefore, Dichtungspartner Hamburg receives the bulk of its products from OEM suppliers and from suppliers whose quality management is certified in accordance with DIN/ISO 9000/9001.

Despite this, we still think it is necessary to check the finished products thoroughly once more within our group according to DIN/ISO 9001. Our high-grade measuring instruments are checking the radial force of oil seals, the tensile strength of elastomers, the compression set and the surface quality by means of computer-based cameras and many more. The results of the checks are registered and filed. It is good to have confidence but qualification is better!

Contents

●	OEM numbers, reference list	6 – 11
●	Engine gaskets and gasket sets	12 – 41
	Cylinder head gaskets, cylinder liner sealing ring kits, cylinder liner sealing rings, complete gasket sets, valve cover gaskets, oil pan gaskets & kits, manifold gaskets, gaskets flywheel	
●	Engine parts, fuel, exhaust and cooling system parts	42 – 71
	Oil seals, washers, o-rings, gaskets, repair kits compressor	
●	Rubber cushions for engine, exhaust systems and gearbox	72 – 73
●	Clutch, gearbox	74 – 80
	Servo cylinders, repair kits, o-rings	
●	Brake parts	81 – 88
	Oil seals, valve lifter, valve guide, valves, repair kits, diaphragms	
●	Front and rear axle parts	89 – 94
●	Bogie lift parts	95 – 96
●	Front and rear suspension parts	97 – 101
●	Overview of most popular oil seal types	102
●	Standard terms and conditions	103 – 104

OEM numbers, reference list

OEM number	page	description
1 070 379-1	43	Oil seal
1 075 255-8	101	Bushing V-stay
1 075 725	46	Sealing ring/Valve stem seal
1 080 437	56	Repair kit (engine)
1 089 552-2	44	Oil seal
1 089 552-2	91	Oil seal front wheel hub, trailing wheel hub
1 134 962-8	100	Rubber bushing
1 139 840-1	43	Oil seal
1 190 064-4	43	Oil seal
1 190 395	56	Repair kit (engine)
1 317 466-9	44	Thermostat seal
1 503 490-3	72	Rubber cushion front engine mount
1 508 996	56	Repair kit (engine)
1 518 358	56	Repair kit (engine)
1 518 359	56	Repair kit (engine)
1 518 360	57	Repair kit (engine)
1 518 399	43	Oil seal
1 518 741	82	Diaphragm brake cylinder
1 522 372-0	92	Oil seal rear axle hub reduction
1 522 373-8	89	Oil seal
1 522 894-3	89	Oil seal
1 522 895-0	90	Oil seal pinion differential carrier
1 522 896	43	Oil seal
1 523 239	43	Oil seal
1 526 181	47	Sealing ring/Valve stem seal
1 526 181	67	Washers
1 526 439	47	Sealing ring/Valve stem seal
1 526 439	71	Gasket
1 526 474-0	80	Seal ring
1 526 525-9	71	Gasket
1 526 688-5	43	Oil seal
1 526 817-0	79	Seal ring
1 526 828-7	75	Oil seal
1 542 780-0	68	Gasket
1 542 781-8	71	Gasket
1 542 783-4	45	Sealing ring
1 543 027	51	Valve
1 544 410-2	45	Thermostat seal
1 545 135-4	48	Valve guide
1 545 135-4	48	Valve guide
1 545 886-2	49	Valve seat ring
1 546 229-4	21	Cylinder liner sealing ring kit
1 546 229-4	22	Liner rings
1 547 492	51	Valve
1 556 472	51	Valve
1 556 473	51	Valve
1 573 891-7	72	Rubber cushion rear engine mount
1 575 339-5	99	Rubber bushing rear anti-roll bar
1 575 525-9	92	Tab washer front wheel hub, steering knuckle
1 580 009-7	99	Rubber bushing rear anti-roll bar
1 580 010-5	99	Rubber bushing rear anti-roll bar
1 581 543-4	95	Plastic bearing bogie
1 586 089-3	98	Shackle bushing spring
1 586 316	73	Motor rubber cushion
1 587 261-7	99	Rubber bushing rear anti-roll bar

OEM number	page	description
1 587 792-1	44	Oil seal
1 587 792-1	91	Oil seal front wheel hub, trailing wheel hub
1 588 445-5	101	Sleeve anti-roll bar
1 589 807-5	98	Plastic bushing front anti-roll bar
1 590 264	57	Repair kit (engine)
1 590 885-8	95	Bushing balance arm bogie suspension
1 591 903-8 (now 1 610 765-8)	91	Oil seal, trailing wheel hub
1 593 431-8	95	Thrust washer balance arm bogie suspension
1 593 459-9	43	Oil seal
1 594 257-6	43	Oil seal
1 594 266	57	Repair kit (engine)
1 598 588	100	Rubber bushing
1 598 761-3 (now 1 608 019-4)	98	Shackle bushing rear spring
1 598 764-7	97	Shackle pin (bolt) rear spring
1 598 766-2	97	Shackle pin (bolt) rear spring, rear end
1 599 919	57	Repair kit (engine)
1 605 047-8	99	Rubber bushing rear anti-roll bar
1 605 093	73	Motor rubber cushion
1 605 182-3	99	Rubber bushing rear anti-roll bar
1 607 561-6	100	Rubber bushing rear anti-roll bar
1 608 019-4 (1 598 761-3)	98	Shackle bushing rear spring
1 609 768-5	99	Rubber bushing rear anti-roll bar
1 609 960-8	97	Shackle pin rear spring
1 610 078-6	68	Gasket
1 610 110-7	98	Shackle bushing spring
1 610 765-8 (1 591 903-8)	91	Oil seal, trailing wheel
1 610 765-8 FPM (944 666-7)	91	Oil seal inner, rear wheel hub
1 611 420-9	72	Rubber cushion front engine mount
1 611 551-1	98	Plastic bushing front anti-roll bar
1 611 815	57	Repair kit (engine)
1 612 335	57	Repair kit (engine)
1 614 229-1	97	Shackle pins front spring
1 614 230-9	97	Shackle pins front spring
1 614 796	82	Diaphragm brake cylinder
1 614 797-7	81	Diaphragm brake cylinder
1 614 798-5	81	Diaphragm brake cylinder
1 614 799-3	81	Diaphragm brake cylinder
1 620 462	57	Repair kit (engine)
1 623 745-5	72	Rubber cushion front engine mount
1 625 954-1	101	Sleeve anti-roll bar
1 655 435	76	Clutch servo cylinder
1 655 638	68	Gasket
1 655 639-1	75	Clutch servo cylinder
1 655 778	68	Gasket
1 655 780-3	68	Gasket
1 664 473-4	46	Sealing ring/Valve stem seal
1 668 501-8	76	Clutch servo cylinder
1 669 618	43	Oil seal
1 672 249-8 (now 1 522 372-0)	92	Oil seal
1 676 306	55	Thermostat
1 695 593	44	Oil seal
1 696 123	58	Repair kit (engine)
1 696 124	58	Repair kit (engine)
1 696 135-8	32	Installation paste
1 696 389-4	78	Support bearing kit propeller shaft

OEM number	page	description
1 696 446-2	83	Thrust pin Z-cam
1 696 448-8 (now 3 090 954-3)	83	Dust cover Z-cam
1 696 450-4	85	Repair kit
1 696 924-8	88	Pinion Z-cam
1 696 925-5	88	Pinion Z-cam
1 697 318	59	Repair kit (engine)
1 697 318	85	Repair kit
151 835-6	56	Repair kit (engine)
151 837-2	68	Gasket
190 418-4	46	Sealing ring/Valve stem seal
190 418-4	47	Sealing ring/Valve stem seal
191 160-1	91	Oil seal front wheel hub
191 179-1	92	Lock washer rear wheel hub, trail. wheel hub
192 600-5	75	Oil seal
231 938-2	43	Oil seal
240 017-4	66	Washers
240 022	43	Oil seal
241 625	44	Oil seal
244 830-6	58	Repair kit (engine)
247 597-7	43	Oil seal
263 567-0	79	Support bearing kit propeller shaft
267 268-1	74	Oil seal gearbox input shaft
267 269-9 (943 704-7)	74	Oil seal gearbox input shaft
267 316-8	74	Oil seal gearbox input shaft
267 386-1	68	Gasket
270 171-2	93	Gasket kit steering gear
270 488	58	Repair kit (engine)
270 549	58	Repair kit (engine)
270 575-4	54	Injector sleeve kit
270 586-1	77	Repair kit clutch servo
270 688	13	Cylinder head gasket set
270 694-3	79	Repair kit air dryer
270 698-4 (now 3 090 471-8)	85	Repair kit air brake compressor
270 751-1	24	Turbo connection gasket set
270 757-8 (now 276 815-6)	24	Turbo connection gasket set
270 758-6 (now 276 815-6)	24	Turbo connection gasket set
270 761-0	14	Complementary gasket set decarbonizing
270 762-8 (275 717-7)	13	Complementary gasket set decarbonizing
270 764-4	23	Manifold gasket set
270 765-1 (275 780-5)	23	Manifold gasket set
270 766-9 (275 449-7)	22	Manifold gasket set
270 768-5 (275 591-6)	23	Manifold gasket set
270 769-3 (275 590-8)	23	Manifold gasket set
270 770-1 (275 523-9)	14	Complementary gasket set decarbonizing
270 771-9	23	Manifold gasket set
270 772-7	24	Manifold gasket set
270 774-3	15	Conversion gasket set engine overhaul
270 775-0 (275 784-7)	16	Conversion gasket set engine overhaul
270 776-8 (now 276 123-7)	16	Conversion gasket set engine overhaul
270 777-6 (275 716-9)	15	Conversion gasket set engine overhaul
270 778-4 (275 718-5)	15	Conversion gasket set engine overhaul
270 779-2 (275 524-7)	15	Conversion gasket set engine overhaul
270 782-6 (275 534-6)	16	Conversion gasket set engine overhaul
270 789-1	12	Cylinder head gasket set
270 823-8	74	Gearbox gasket set
270 824-6	74	Gearbox gasket set
270 890	86	Repair kit
270 909	58	Repair kit (engine)
270 910	86	Repair kit
270 925-1	78	Repair kit split cylinder
270 926-9	78	Repair kit range cylinder
270 935-0	19	Cylinder liner sealing ring kit
270 946-7	54	Injector sleeve kit
270 949-1	13	Cylinder head gasket set

OEM number	page	description
270 950-9	19	Cylinder liner sealing ring kit
270 957-4 (275 528-8)	15	Conversion gasket set engine overhaul
270 958-2	23	Manifold gasket set
270 969	86	Repair kit
270 997-0 (275 529-6)	24	Turbo connection gasket set
271 089-5	24	Turbo connection gasket set
271 106-7	76	Repair kit clutch master cylinder
271 130-7 (now 276 125-2)	17	Conversion gasket set engine overhaul
271 155-4	19	Cylinder liner sealing ring kit
271 156-2 (275 730-0)	19	Cylinder liner sealing ring kit
271 157-0	18	Cylinder liner sealing ring kit
271 158-8 (275 734-2)	18	Cylinder liner sealing ring kit
271 159-6 (275 778-9)	18	Cylinder liner sealing ring kit
271 160-4 (275 461-2)	18	Cylinder liner sealing ring kit
271 161-2 (275 772-2)	18	Cylinder liner sealing ring kit
271 162-0 (275 567-6)	18	Cylinder liner sealing ring kit
271 181-0	19	Cylinder liner sealing ring kit
271 194-3	76	Repair kit clutch servo
271 195-0 (now 276 335-7)	77	Repair kit gearbox inhibitor valve
271 197-6 (now 3 094 518-2)	78	Repair kit for cover to split and range cylinder
271 198-4 (now 3 094 518-2)	78	Repair kit for cover to split and range cylinder
271 252	58	Repair kit (engine)
271 524-1	93	Gasket kit steering gear
271 525-8	93	Gasket kit steering gear
271 526-6	59	Repair kit (engine)
271 560-5	94	Gasket kit steering gear
271 561	93	Gasket kit steering gear
271 567-0	93	Gasket kit steering gear
272 571	86	Repair kit
272 574	59	Repair kit (engine)
272 575	59	Repair kit (engine)
272 576	59	Repair kit (engine)
272 577	86	Repair kit
272 623	59	Repair kit (engine)
272 624	59	Repair kit (engine)
272 625	59	Repair kit (engine)
272 626	60	Repair kit (engine)
272 631	60	Repair kit (engine)
272 632	60	Repair kit (engine)
272 660	60	Repair kit (engine)
272 665 (now 3 090 471-8)	85	Repair kit air brake compressor
272 709	60	Repair kit (engine)
272 712	86	Repair kit
272 721-2	81	Repair kit air dryer drain valve
272 726	60	Repair kit (engine)
272 730	60	Repair kit (engine)
272 731	86	Repair kit
272 760-0	79	Repair kit air dryer
272 790	87	Repair kit
272 794	87	Repair kit
272 801	61	Repair kit (engine)
272 808	61	Repair kit (engine)
272 813-7	85	Repair kit air brake compressor
272 860	87	Repair kit
272 864	61	Repair kit (engine)
272 866	61	Repair kit (engine)
272 875	87	Repair kit
272 878	61	Repair kit (engine)
272 884	61	Repair kit (engine)
272 896	61	Repair kit (engine)
272 905-1	84	Sealing kit Z-cam
272 910-1	84	Cross shaft Z-cam
273 081-0	77	Repair kit gearbox control cylinder
273 082-8	77	Repair kit gearbox inhibitor valve

OEM number	page	description
273 375	62	Repair kit (engine)
273 394-7	92	Oil seal kit rear axle hub reduction
273 404-4	96	Gasket kit bogie lift cylinder
273 632-0	76	Repair kit clutch servo
273 660-1	76	Repair kit clutch master cylinder
273 665-0	78	Repair kits split cylinder
273 706	62	Repair kit (engine)
273 712-0	96	Gasket kit bogie lift cylinder
273 821-9 (now 276 130-2)	17	Injector sleeve kit
273 822-7	54	Injector sleeve kit
273 983-7	54	Injector sleeve kit
274 104	62	Repair kit (engine)
274 105	62	Repair kit (engine)
274 106	62	Repair kit (engine)
275 449-7 (now 270 766-9)	22	Manifold gasket set
275 460-4	18	Cylinder liner sealing ring kit
275 461-2 (now 271 160-4)	18	Cylinder liner sealing ring kit
275 523-9 (now 270 770-1)	14	Complementary gasket set decarbonizing
275 524-7 (now 270 779-2)	15	Conversion gasket set engine overhaul
275 525-4	12	Cylinder head gasket set
275 528-8 (now 270 957-4)	15	Conversion gasket set engine overhaul
275 529-6 (now 270 997-0)	24	Turbo connection gasket set
275 530-4 (now 276 034-6)	14	Complementary gasket set decarbonizing
275 531-2 (now 276 122-9)	16	Conversion gasket set engine overhaul
275 533-8	14	Complementary gasket set decarbonizing
275 534-6 (now 270 782-6)	16	Conversion gasket set engine overhaul
275 548-6	13	Cylinder head gasket set
275 551-0	12	Cylinder head gasket set
275 554-4	15	Complementary gasket set decarbonizing
275 555-1 (now 276 124-5)	16	Conversion gasket set engine overhaul
275 566-8 (now 275 740-9)	12	Cylinder head gasket set
275 567-6 (now 271 162-0)	18	Cylinder liner sealing ring kit
275 570 (now 276 155-9)	55	Oil pump repair kit
275 590-8 (now 270 769-3)	23	Manifold gasket set
275 591-6 (now 270 768-5)	23	Manifold gasket set
275 715-1	62	Repair kit (engine)
275 716-9 (now 270 777-6)	15	Conversion gasket set engine overhaul
275 717-7 (now 270 762-8)	13	Complementary gasket set decarbonizing
275 718-5 (now 270 778-4)	15	Conversion gasket set engine overhaul
275 730-0 (now 271 156-2)	19	Cylinder liner sealing ring kit
275 731	55	Oil pump repair kit
275 734-2 (now 271 158-8)	18	Cylinder liner sealing ring kit
275 737-5 (now 271 160-4)	18	Cylinder liner sealing ring kit
275 740-9 (275 566-8)	12	Cylinder head gasket set
275 741-7	15	Complementary gasket set decarbonizing
275 751-6	17	Cylinder liner sealing ring kit
275 754-0 (now 276 035-3)	14	Complementary gasket set decarbonizing
275 772-2 (now 271 161-2)	18	Cylinder liner sealing ring kit
275 774-8 (now 276 821-6)	12	Cylinder head gasket set
275 776-3	14	Complementary gasket set decarbonizing
275 778-9 (now 271 159-6)	18	Cylinder liner sealing ring kit
275 779-7 (now 276 816-6)	12	Cylinder head gasket set
275 780-5 (now 270 765-1)	23	Manifold gasket set
275 781-3	14	Complementary gasket set decarbonizing
275 784-7 (now 270 775-0)	16	Conversion gasket set engine overhaul
275 785-4	16	Conversion gasket set engine overhaul
276 034-6 (275 530-4)	14	Complementary gasket set decarbonizing
276 035-3 (275 754-0)	14	Complementary gasket set decarbonizing
276 052-8	23	Manifold gasket set
276 052-8	24	Manifold gasket set
276 096-5	84	Repair kit adjusting pin Z-cam
276 097-3	83	Repair kit reverse lock Z-cam
276 098-1	83	Repair kit reverse lock Z-cam
276 108-8	77	Repair kit gearbox inhibitor valve

OEM number	page	description
276 110-4	96	Gasket kit bogie lift cylinder
276 122-9 (275 531-2)	16	Conversion gasket set engine overhaul
276 123-7 (270 776-8)	16	Conversion gasket set engine overhaul
276 124-5 (275 555-1)	17	Conversion gasket set engine overhaul
276 125-2 (271 130-7)	17	Conversion gasket set engine overhaul
276 130-2 (273 821-9)	54	Injector sleeve kit
276 140-1	93	Gasket kit steering gear
276 146-8	77	Repair kit gearbox control cylinder
276 155-9 (275 570)	55	Oil pump repair kit
276 156	56	Oil pump repair kit
276 335-7 (271 195-0)	77	Repair kit gearbox inhibitor valve
276 543	62	Repair kit (engine)
276 546-9	76	Repair kit clutch master cylinder
276 813-3 (now 3 094 518-2)	78	Repair kit for cover to split and range cylinder
276 815-6 (270 757-8)	24	Turbo connection gasket set
276 815-6 (270 758-6)	24	Turbo connection gasket set
276 816-6	12	Cylinder head gasket set
276 821-6	12	Cylinder head gasket set
3 028 447-5	100	Rubber bushing
3 028 448-3	100	Rubber bushing
3 028 449-1	100	Rubber bushing
3 090 266-2	87	King pin kit
3 090 267-0	87	King pin kit
3 090 288	63	Repair kit (engine)
3 090 331-4	91	Sealing kit outer, rear wheel hub
3 090 377	63	Repair kit (engine)
3 090 379	63	Repair kit (engine)
3 090 388	63	Repair kit (engine)
3 090 471-8 (270 698-4)	85	Repair kit air brake compressor
3 090 954-3 (1696448-8)	83	Dust cover Z-cam
3 090 964-2	84	Repair kit adjusting pin Z-cam
3 093 503	13	Cylinder head gasket set
3 094 155	63	Repair kit (engine)
3 094 156	63	Repair kit (engine)
3 094 518-2 (271 197-6)	78	Repair kit for cover to split and range cylinder
3 094 518-2 (271 198-4)	78	Repair kit for cover to split and range cylinder
3 094 518-2 (276 813-3)	78	Repair kit for cover to split and range cylinder
3 097 092-5	83	Return spring Z-cam
3 097 099-0	84	Repair kit brake adjusting Z-cam
3 097 100-6 (now 8 550 977-6)	84	Repair kit brake adjusting Z-cam
3 097 147	63	Repair kit (engine)
3 099 100	13	Cylinder head gasket set
3 123 521-1	43	Oil seal
3 514 943	44	Oil seal
325 197	81	Diaphragm brake cylinder
328 752	64	Repair kit (engine)
338 425	89	Oil seal
341 050-3	90	Oil seal steering gear
341 488-5	69	Gasket
346 499-7	82	Tension spring brake shoe S-cam
346 822-0	44	Oil seal
353 314	81	Diaphragm brake cylinder
363 908-5	95	Bolt bogie roller
382 010-7	69	Gasket
382 055	69	Gasket
382 361-4	79	Gasket for oil filter
414 621-3	52	Strainer oil pump
415 424-1	47	Sealing ring/Valve stem seal
416 033-9	44	Thermostat seal
418 360-4	66	Washers
418 411-5	66	Washers
418 412-3	66	Washers
420 066-3	32	Valve cover gasket
420 160	69	Gasket

OEM number	page	description
420 538-1	37	Gasket exhaust manifold
420 618-1	69	Gasket
420 641-3	69	Gasket
420 642-1	69	Gasket
420 708-0	37	Gasket exhaust manifold
420 941-7	35	Oil pan gasket
421 011-8	50	Valve seat ring
421 012-6	49	Valve seat ring
421 025-8	35	Oil pan gasket
421 066-2	33	Valve cover gasket
421 067-0	48	Valve lifter
421 121-5	34	Gasket inspection cover cylinder block
421 131-4	39	Felt ring crankshaft front sealing
421 147-0	40	Felt ring crankshaft rear sealing
421 158-7	66	Washers
421 226	19	Cylinder liner sealing ring kit
421 226	21	Liner rings
421 297-3	48	Valve guide
421 297-3	48	Valve guide
421 534-9	37	Gasket exhaust manifold
422 011-7	49	Valve seat ring
422 012-5	49	Valve seat ring
422 025-7 (now 424 604-7)	35	Oil pan gasket
422 145-3	40	Felt ring crankshaft rear sealing
422 146-1	40	Felt ring crankshaft front sealing
422 219-6	19	Cylinder liner sealing ring kit
422 219-6	21	Liner rings
422 320-2	48	Valve guide
422 619-7	64	Cylinder liner adjusting shim
422 620-5	64	Cylinder liner adjusting shim
422 621-3	64	Cylinder liner adjusting shim
422 713-0	20	Cylinder liner sealing ring kit
422 713-0	21	Liner rings
422 779-9	70	Gasket
423 011-6	49	Valve seat ring
423 139-5 (now 479 260-2)	32	Water seal cylinder
423 145-2	33	Valve cover gasket
423 146-0	33	Valve cover gasket
423 174-2	38	Gasket intake manifold
423 281-5	66	Washers
424 276-4	35	Oil pan gasket
424 580-9	55	Oil seal injection pump driving unit
424 594	19	Cylinder liner sealing ring kit
424 594	21	Liner rings
424 595-7	20	Cylinder liner sealing ring kit
424 595-7	21	Liner rings
424 600-5	34	Oil pan gasket
424 601-3	34	Oil pan gasket
424 602-1	34	Oil pan gasket
424 602-1	35	Oil pan gasket
424 603-9	34	Oil pan gasket
424 604-7 (422 025-7)	35	Oil pan gasket
424 605-4	35	Oil pan gasket
424 607-0	35	Oil pan gasket
424 610-4	38	Gasket intake manifold
424 611-2	38	Gasket intake manifold
424 612-0	38	Gasket intake manifold
424 618-7	70	Gasket
424 621-1	17	Gasket flywheel housing
424 634-4	37	Gasket exhaust manifold
424 692-2 (468 352-0)	33	Valve cover gasket
424 692-2 (468 963-4)	33	Valve cover gasket
424 693-0	33	Valve cover gasket
424 694-8	33	Valve cover gasket

OEM number	page	description
424 763-1	42	Oil seal crankshaft front sealing
424 830-8	20	Cylinder liner sealing ring kit
424 830-8	21	Liner rings
424 831-6	20	Cylinder liner sealing ring kit
424 831-6	22	Liner rings
424 832-4	20	Cylinder liner sealing ring kit
424 832-4	22	Liner rings
424 833-2	20	Cylinder liner sealing ring kit
424 833-2	22	Liner rings
424 918-1	34	Oil pan gasket
424 919-1	35	Oil pan gasket
424 983-5 (469 507-8)	42	Oil seal crankshaft front sealing
424 983-5 FPM A/BS RD W	42	Oil seal crankshaft front sealing
424 983-5 MVQ AS W RD	42	Oil seal crankshaft front sealing
465 394-5	64	Cylinder liner adjusting shim
465 395-2	64	Cylinder liner adjusting shim
465 396-0	64	Cylinder liner adjusting shim
465 547-8	52	Injector sleeve
465 551-7	70	Gasket
465 906-6	20	Cylinder liner sealing ring kit
465 906-6	22	Liner rings
465 952-0	32	Valve cover gasket
466 114-6	64	Cylinder liner adjusting shim
466 183-1	64	Cylinder liner adjusting shim
466 184-9	64	Cylinder liner adjusting shim
466 284-7	52	Injector sleeve
466 386-0	48	Valve guide
466 403-3	53	Injector sleeve
466 404-1	53	Injector sleeve
466 405-8	55	Injector seal
466 420-7	64	Steel ring injector sleeve
466 739-0	46	Sealing ring/Valve stem seal
466 740-8	46	Sealing ring/Valve stem seal
466 878-6	64	Cylinder liner adjusting shim
466 922-2	65	O-ring injector sleeve
467 177-2	39	Gasket timing gear casing cover
467 365-3	52	Plug cylinder head
467 367-9	52	Plug cylinder head, cylinder block
467 417-2	53	Injector sleeve
467 475-0	49	Valve seat ring
467 502	50	Valve
467 502-1	50	Valve
467 855	50	Valve
467 855-3	51	Valve
468 116-9	39	Gasket timing gear casing cover
468 210-0	54	Injector seal
468 263-9	53	Injector sleeve
468 271-2	64	Cylinder liner adjusting shim
468 272-0	64	Cylinder liner adjusting shim
468 273-8	64	Cylinder liner adjusting shim
468 302	50	Valve
468 302-5	51	Valve
468 303	50	Valve
468 303-3	51	Valve
468 352-0 (now 424 692-2)	33	Valve cover gasket
468 448-6	49	Valve seat ring
468 557-4	17	Gasket flywheel housing
468 582-1	71	Gasket
468 784-4	53	Injector sleeve
468 963-4 (now 424 692-2)	33	Valve cover gasket
469 205-9	54	Injector seal
469 240-6	50	Valve
469 259-6	39	Gasket timing gear casing cover
469 327-1	32	Gasket for plugs to cylinder block

OEM number	page	description
469 327-1	52	Plug gasket
469 328-9	32	Gasket for plugs to cylinder block
469 328-9	52	Plug gasket
469 336-2	42	Oil seal crankshaft rear sealing
469 336-2	44	Oil seal
469 445	20	Cylinder liner sealing ring kit
469 445	22	Liner rings
469 455-0	55	Injector seal
469 456-8	47	Sealing ring/Valve stem seal
469 477-4	66	Washers
469 479-0	66	Washers
469 481-6	66	Washers
469 482-4	67	Washers
469 483-2	17	Rubber seal oil filter housing
469 484-0	36	Rubber gasket oil filter housing
469 486-5	36	Rubber gasket oil filter housing
469 487-3	36	Rubber gasket oil filter housing
469 507-8 (now 424 983-5)	42	Oil seal crankshaft front sealing
469 508-6	47	Sealing ring/Valve stem seal
469 509-4	47	Sealing ring/Valve stem seal
469 606-8	67	Washers
469 661-3	38	Gasket intake manifold
469 662-1	38	Gasket intake manifold
469 668-8	47	Sealing ring/Valve stem seal
469 823-9	34	Gasket inspection cover cylinder block
469 829-6	38	Gasket intake manifold
469 846-0	67	Washers
469 908-8	45	Sealing ring
469 952-6	67	Washers
470 247-8	53	Injector sleeve
470 383-1	67	Washers
470 534-9	37	Gasket exhaust manifold
470 939-0	70	Gasket
470 993-7	70	Gasket
471 055-4 (now 477 118-4)	42	Oil seal crankshaft front sealing
471 056-2 (now 477 119-2)	42	Oil seal crankshaft rear sealing
471 419-2	19	Cylinder liner sealing ring kit
471 419-2	21	Liner rings
471 424-2	21	Cylinder liner sealing ring kit
471 424-2	22	Liner rings
471 465-5	36	Rubber gasket oil cooler
471 467-1	39	Rubber seal oil cooler
471 520-7	33	Valve cover gasket
471 626-2	67	Washers
471 637-9	39	Rubber seal oil cooler pipe
471 650-2	37	Gasket exhaust manifold
471 788-0	45	Thermostat seal
471 856-5	67	Washers
471 956-3	32	Rubber seal
471449-9	45	Sealing ring
477 059-0	47	Sealing ring/Valve stem seal
477 118-4 (471 055-4)	42	Oil seal crankshaft front sealing
477 118-4 FPM A/BS RD	42	Oil seal crankshaft front sealing
477 118-4 MVQ ARD	42	Oil seal crankshaft front sealing
477 119-2 (471 056-2)	42	Oil seal crankshaft rear sealing
477 119-2 FPM A/BS LD	42	Oil seal crankshaft rear sealing
477 119-2 MVQ ALD	42	Oil seal crankshaft rear sealing
478 074-8	70	Gasket
478 505-1	35	Oil pan gasket
479 031-7	48	Valve lifter
479 107-5	37	Gasket exhaust manifold
479 163-8	53	Injector sleeve
479 204	50	Valve
479 204	50	Valve

OEM number	page	description
479 260-2 (423 139-5)	32	Water seal cylinder
479 264-4	35	Oil pan gasket
479 484-8	35	Oil pan gasket
479 486-3	36	Oil pan gasket
6 645 225-1	85	Repair kit air brake compressor
6 771 541-7	44	Oil seal
6 850 149-3	72	Rubber cushion exhaust system
6 876 126-1	75	Oil seal
6 876 127-9	75	Oil seal
6 876 142-8	44	Oil seal
8 148 574	51	Valve
8 149 182-1	55	Thermostat
8 550 977-6	84	Repair kit brake adjusting Z-cam
821 755-6	44	Oil seal
846 937	46	Sealing ring/Valve stem seal
925 053-1	47	Sealing ring/Valve stem seal
925 059-8	47	Sealing ring/Valve stem seal
925 063-0	47	Sealing ring/Valve stem seal
925 068-9	79	Seal ring
925 069-7	46	Sealing ring/Valve stem seal
925 091-1	47	Sealing ring/Valve stem seal
925 092-9	46	Sealing ring/Valve stem seal
925 094-5	47	Sealing ring/Valve stem seal
925 095-2	46	Sealing ring/Valve stem seal
925 257-8	47	Sealing ring/Valve stem seal
925 258-6	47	Sealing ring/Valve stem seal
925 259-4	46	Sealing ring/Valve stem seal
925 261-0	94	O-ring for hub cap
925 266	46	Sealing ring/Valve stem seal
940 096-1	36	Rubber seal oil filter cap
941 666-0	40	Felt ring crankshaft front sealing
941 705-6	82	O-Ring anchor pin
941 916-9	98	Spring washer
942 083-7	40	Felt ring crankshaft front sealing
942 089-4	46	Sealing ring/Valve stem seal
942 580-2	66	Washers
943 177-6	41	O-Ring oil cooler
943 250-1	89	Oil seal
943 704-7 (now 267 269-9)	74	Oil seal gearbox input shaft
943 741-9	75	Oil seal
944 665-9	89	Oil seal
944 666-7 (now 1 610 765-8 FPM)	91	Oil seal inner, rear wheel hub
944 667-5	91	Oil seal front wheel hub
944 670-9	92	Wear ring rear axle hub, trailing wheel hub
944 671-7	89	Oil seal
944 988-5	40	O-Ring oil cooler
945 538-7	96	Oil seal balance arm bogie suspension
946 026-2	90	Oil seal
946 093-2	44	Oil seal
946 733	46	Sealing ring/Valve stem seal
947 270-5	90	Oil seal
947 620-1	66	Washers
947 622	66	Washers
947 705	75	Oil seal
948 254	46	Sealing ring/Valve stem seal
948 448-6	90	Oil seal companion flange differential carrier
948 610-1	47	Sealing ring/Valve stem seal
948 642-8	90	Oil seal
948 767-9	93	O-ring rear axle hub
948 826-3	44	Oil seal
948 983-2	47	Sealing ring/Valve stem seal
949 573	44	Oil seal
949 656-3	41	O-Ring oil cooler
949 657-1	47	Sealing ring/Valve stem seal

OEM number	page	description
949 658-9	47	Sealing ring/Valve stem seal
949 659-7	47	Sealing ring/Valve stem seal
949 721-5	47	Sealing ring/Valve stem seal
949 722-3	80	Seal ring
951 982-8	88	Expansion pin for anchor pin
951 983-6	88	Expansion pin for anchor pin
955 984-0	47	Sealing ring/Valve stem seal
957 187	66	Washers
958 811-2	45	Sealing ring coolant pump
958 861-7	44	Oil seal
960 218-6	47	Sealing ring/Valve stem seal
967 344-3	78	O-Ring cover range cylinder
967 852-5	94	Seal ring
968 012-5	94	Wheel accessory kit
968 013-3	94	Wheel accessory kit
969 219-5	82	O-Ring anchor pin
969 220-3	82	O-Ring anchor pin
975 610-7	85	O-ring compressor connection
977 176	47	Sealing ring/Valve stem seal
977 751	66	Washers
CS-130	17	Conversion gasket set engine overhaul
CS-200	16	Conversion gasket set engine overhaul
CS-201	16	Conversion gasket set engine overhaul
CS-202	16	Conversion gasket set engine overhaul
CS-203	17	Conversion gasket set engine overhaul
FS-1000	26	Gasket set complete engine overhaul
FS-1001	26	Gasket set complete engine overhaul
FS-1003	26	Gasket set complete engine overhaul
FS-1011	26	Gasket set complete engine overhaul
FS-1012	26	Gasket set complete engine overhaul
FS-1013	26	Gasket set complete engine overhaul
FS-11000	29	Gasket set compl. engine overhaul without...
FS-11001	29	Gasket set compl. engine overhaul without...
FS-11003	29	Gasket set compl. engine overhaul without...
FS-11011	29	Gasket set compl. engine overhaul without...
FS-12000	29	Gasket set comp. engine overhaul without...
FS-1500	28	Gasket set compl. engine overhaul without...
FS-1601	28	Gasket set compl. engine overhaul without...
FS-1602	28	Gasket set compl. engine overhaul without...
FS-1603	28	Gasket set compl. engine overhaul without...
FS-1610	28	Gasket set compl. engine overhaul without...
FS-1700	28	Gasket set compl. engine overhaul without...
FS-1701	28	Gasket set compl. engine overhaul without...
FS-1710	28	Gasket set compl. engine overhaul without...
FS-2000	26	Gasket set complete engine overhaul
FS-2001	26	Gasket set complete engine overhaul
FS-2002	27	Gasket set complete engine overhaul
FS-2010	27	Gasket set complete engine overhaul
FS-2011	27	Gasket set complete engine overhaul
FS-2200	27	Gasket set complete engine overhaul
FS-22001	29	Gasket set compl. engine overhaul without...
FS-2201	27	Gasket set complete engine overhaul
FS-22010	29	Gasket set compl. engine overhaul without...
FS-22012	29	Gasket set compl. engine overhaul without...
FS-2202	27	Gasket set complete engine overhaul
FS-2210	27	Gasket set complete engine overhaul
FS-2212	27	Gasket set complete engine overhaul
FS-22200	29	Gasket set compl. engine overhaul without...
FS-22202	29	Gasket set compl. engine overhaul without...
FS-22202	29	Gasket set compl. engine overhaul without...
FS-22212	29	Gasket set compl. engine overhaul without...
FS-500	25	Gasket set complete engine overhaul
FS-600	25	Gasket set complete engine overhaul
FS-601	25	Gasket set complete engine overhaul





OEM number	page	description
FS-602	25	Gasket set complete engine overhaul
FS-603	25	Gasket set complete engine overhaul
FS-610	25	Gasket set complete engine overhaul
FS-700	26	Gasket set complete engine overhaul
FS-701	26	Gasket set complete engine overhaul
FS-710	26	Gasket set complete engine overhaul
HS-5000	30	Decarbonizing gasket set
HS-6001	30	Decarbonizing gasket set
HS-6002	30	Decarbonizing gasket set
HS-6003	30	Decarbonizing gasket set
HS-6010	30	Decarbonizing gasket set
HS-7000	30	Decarbonizing gasket set
HS-7010	30	Decarbonizing gasket set
HS-8000	31	Decarbonizing gasket set
HS-8001	31	Decarbonizing gasket set
HS-8002	31	Decarbonizing gasket set
HS-8003	31	Decarbonizing gasket set
HS-8004	31	Decarbonizing gasket set
HS-8005	31	Decarbonizing gasket set
HS-8006	31	Decarbonizing gasket set
HS-9000	31	Decarbonizing gasket set
HS-9001	31	Decarbonizing gasket set

Engine gaskets and gasket sets

Cylinder head gasket set

dph-no.	OEM-no.	application
36653	275 740-9	D50A, D50B, TD50A, TD50B, D60A, TD60A, TD60B, TD60C Head gasket marked DPH
81615	276 821-6	TD61F, TD61FB, TD61FBQ, TD61FHQ, TD61G, TD61GA, TD61GB, TD61GC, TD61GE, TD61GS, TD63E, TD63ES, D6A
36279	275 525-4	D70A, D70B, TD70A, TD70B, TD70C, TD70D, TD70E, TD70F, TD70FC, TD70FS, TD70G, TD70H, TD70HA
81844	276 816-6	TD71F, TD71FA, TD71FAQ, TD71FC, TD71FCQ, TD71FD, TD71FQ, TD71FS, TD71FSQ, TD71G, TD73E, TD73ES, D7A, D7B Head gasket marked DPH
36030	275 551-0	D100A#, TD100A#, D100B, TD100C, HD100A*, TD100C, HD100D**, THD100D**, THD100DA, THD100DB, THD100DC, THD100DD, THD100A* # from engine 18536- * from engine 2499- Head gasket marked DPH
36501	270 789-1	TD100BG, TD100G, TD100GA, THD100EC, THD100ED, THD100EE, THD100EK, TD101, THD101, TD102, THD102, TD103, TD103, THD103, THD104KB, THD104KF, THD100EA, THD100EB, D10A, DH10A Head gasket marked DPH

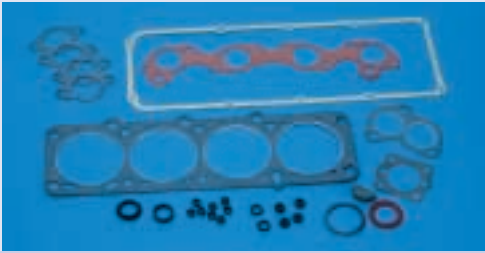
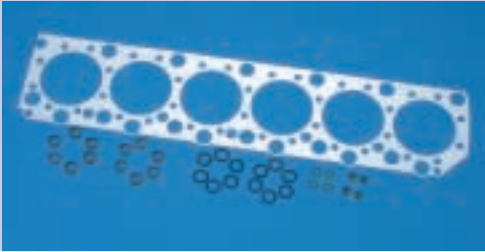





Cylinder head gasket set

dph-no.	OEM-no.	application
51347	275 548-6	 <p>TD120, TD121F, TD121FA, TD121FB, TD121FC, TD121FD, TD121FE, TD121FK, TD121G*, TD121GD*, TD121FF * up to engine -131995 Head gasket marked DPH</p>
36281	270 949-1	 <p>TD121G*, TD121GD*, TD122, TD123E, TD123ES * from engine 131996- Head gasket marked DPH</p>
95739	270 688	
98542	3 093 503	 <p>Cylinder head gasket FH 12 Old version</p>
110207	3 099 100	 <p>Cylinder head gasket FH 12 New version</p>

Complementary gasket set decarbonizing

dph-no.	OEM-no.	application
36520	270 762-8	 <p>TD60B, TD60C</p>





Complementary gasket set decarbonizing

dph-no.	OEM-no.	application
36277	275 776-3	 <p>TD61F, TD61FB, TD61FBQ, TD61FHQ, TD61G, TD61GA, TD61GB, TD61GC, TD61GE, TD61GS, TD63E, TD63ES</p>
36522	270 761-0	 <p>D70A, D70B, TD70B, TD70C, TD70D, TD70E, TD70F, TD70FS, TD70G, TD70H, TD70HA, TD70A, TD70FC</p>
36278	275 781-3	 <p>TD71F, TD71FA, TD71FAQ, TD71FC TD71FCQ, TD71FD, TD71FQ, TD71FS, TD71FSQ, TD71G</p>
36523	276 034-6	 <p>D100A, D100B, TD100A, TD100B, TD100BG, TD100C* * up to engine -145715</p>
36511	276 035-3	 <p>TD100C*, TD100G, TD100GA, TD101, TD102, TD103, D10A *from engine 145716-</p>
36518	270 770-1	 <p>D50A, D50B, TD50B, D60A, TD60A</p>
36525	275 533-8	 <p>HD100A, HD100D, THD100A, THD100D*, THD100DA*, THD100B*, THD100DC*, THD100DD* * up to engine -23198</p>

Complementary gasket set decarbonizing

dph-no.	OEM-no.	application
36542	275 741-7	 <p>THD100D*, THD100DA*, THD100DB*, THD100DC*, THD100DD*, THD100EA, THD100EB, THD100EC, THD100ED, THD100EE, THD100EK, THD101, THD102, THD103, THD104KB, THD104KF, DH10A</p> <p>* from engine 23199-</p>
36099	275 554-4	 <p>TD120, TD121, TD122, TD123</p>

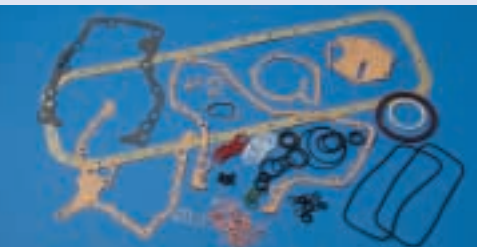

Conversion gasket set engine overhaul

dph-no.	OEM-no.	application
36543	270 779-2	 <p>D50A, D50B, TD50A, TD50B, D60A, TD60A</p>
36545	270 778-4	 <p>TD60B, TD60C</p>
36547	270 774-3	 <p>TD61F, TD61FB, TD61FBQ, TD61FHQ, TD61G, TD61GA, TD61GB, TD61GC, TD61GE, TD61GS</p> <p>Not for engines with plastic laminate oil pan</p>
36505	270 957-4	 <p>D70A, D70B, TD70A, TD70B, TD70C, TD70D, TD70E, TD70H*, TD70HA*,</p> <p>* for buses B57, BB57</p>
36549	270 777-6	 <p>TD70F, TD70FC, TD70FS, TD70G; TD70H*, TD70HA*</p> <p>* excl. buses B57, BB57</p>

Conversion gasket set engine overhaul

dph-no.	OEM-no.	application
36291	270 775-0	<p>TD71F, TD71FA, TD71FAQ, TD71FC, TD71FCQ, TD71FD, TD71FS, TD71G</p> <p>Not for engines with plastic laminate oil pan</p>
93372 37487	276 122-9 CS-200	D100A, D100B, TD100A, TD100B, TD100BG, TD100C
93372 37488	276 122-9 CS-201	<p>TD100G, TD100GA, TD101F*, TD101FA*, TD100G*, TD101GA, TD101GB</p> <p>* NOT for FL10</p>
36552	276 123-7	<p>TD101F*, TD101FA*, TD101FC*, TD101FD*, TD101G*, TD102F, TD102FD, TD102FDQ, TD102FF, TD102FH, TD102FQ, TD102FS</p> <p>Not for engines with plastic laminate oil pan * for FL10</p>
36504	270 782-6	HD100A, HD100D, THD100A, THD100D, THD100DA, THD100DB, THD100DC, THD100DD, THD100EA, THD100EB, THD100EC, THD100ED, THD100EE, THD100EK
36555	275 785-4	<p>THD101GB, THD101GC, THD101GD, THD101GK, THD101KB, THD101KC, THD101KD, THD101KE, THD101KF, THD101KA, THD102KA, THD102KB, THD102KD, THD102KF* THD103KB, THD103KD, THD103KF, THD104KB, THD104KF * excl.B10R</p>
81436 37489	276 124-5 CS-202	TD 120 up to engine -55607

Conversion gasket set engine overhaul

dph-no.	OEM-no.	application
81436 37584	276 124-5 CS-203	 TD120 from engine 55608- TD121F, TD121FA, TD121FB, TD121FC, TD121FD, TD121FE, TD121FF, TD121FK, TD121G*, TD121GD* *up to engine -131995
84456	276 125-2 CS-130	 TD121G*, TD121GD*, TD122 *from engine no. 131996- Not for engines with plastic laminate oil pan

Rubber seal oil filter housing

dph-no.	OEM-no.	application
61480	469 483-2	 TD40A, TD41G, D50, TD50, D60, TD60, TD61, TD63, D100, TD100, TD101, TD102, TD103, TD120, TD121, TD122, TD123 For oil cooler pipe to: HD100, THD100, THD101, THD10, THD103, THD104, DH10A Size: 22x28x3 FPM 70

Gasket flywheel housing

dph-no.	OEM-no.	application
37589	424 621-1	 D100, TD100, HD100, THD100, TD101, THD101, TD120, TD121
36038	468 557-4	 D100, HD100, TD100, THD100, TD101, THD101, TD120, TD121







Cylinder liner sealing ring kit

dph-no.	OEM-no.	application
51555	275 751-6	 TD40A, TD41G Contents: 2 pcs 96,00 x 3,00 FPM 75 purple 1 pc 99,50 x 3,00 FPM 70 black 1 pc 102,00 x 1,60 FPM 75 black 1 pc installation paste







Cylinder liner sealing ring kit

dph-no.	OEM-no.	application
36097	275 460-4	<p>D50A, D50B, TD50A, TD50B</p> <p>Contents: 2 pcs 106,50 x 5,70 EPDM 70 1 pc 103,50 x 1,60 FPM 75 green 1 pc installation paste</p>
36096	271 162-0	<p>D60A,TD60A,TD60B,TD60C</p> <p>Contents: 1 pc 108,50 x 5,80 FPM 75 black 1 pc 108,50 x 5,80 FPM 75 purple 1 pc 105,50 x 1,60 FPM 75 black 1 pc installation paste</p>
36095	271 161-2	<p>TD61F, FB, FBQ, FHQ, G, GA, GB, GC, GE, GS TD63E, TD63ES</p> <p>Contents: 2 pcs 108,50 x 5,80 FPM 75 black 1 pc 108,50 x 5,80 FPM 75 purple 1 pc 105,50 x 1,60 FPM 75 black 1 pc installation paste</p>
36094	271 160-4	<p>D70A, D70B, TD70A, TD70B, TD70C, TD70D, TD70E, TD70F, TD70FC, TD70FS, TD70G, TD70H, TD70HA</p> <p>Contents: 1 pc 115,80 x 5,80 FPM 75 black 1 pc 115,80 x 5,80 FPM 75 purple 1 pc 114,00 x 1,60 FPM 75 black 1 pc installation paste</p>
36093	271 159-6	<p>TD71F, TD71FA, TD71FAQ, TD71FC, TD71FD, TD71FQ, TD71FS, TD71FSQ, TD71G, TD73E, TD73ES</p> <p>Contents: 2 pcs 115,80 x 5,80 FPM 75 black 1 pc 115,80 x 5,80 FPM 75 purple 1 pc 114,00 x 1,60 FPM 75 black 1 pc installation paste</p>
36033	271 158-8	<p>D100A, D100B, TD100A, B, BG, C, G, GA, HD100A, HD100D, THD100A, D, DA, DB, DC, DD, EA, EB, EC, ED, EE, EK, TD101F, FA, FC, FD, G, GA, GB up to engine -199157 THD101GB, GC, GD, GK, KB, KC, KD, KE, KF up to engine -40891</p> <p>Contents: 1 pc 132,50 x 1,60 FPM 75 black 1 pc 132,70 x 5,70 FPM 75 purple 1 pc 132,70 x 5,70 FPM 75 black 1 pc installation paste</p>
36377	271 157-0	<p>TD101F, FA, FC, FD, G, GA, GB from engine 199158- THD101GB, GC, GD, GK, KB, KC, KD KE, KF from engine -40891 ID102F, FD, FDQ, FF, FH, FL, FM, FQ, FS, KF, THD102 all, TD103E, EA, ES, THD103KB, KD, KF, THD104KB, KF</p> <p>Contents: 1 pc 132,50 x 2,40 FPM 75 black 1 pc 133,80 x 5,70 FPM 75 purple 1 pc 133,80 x 5,70 FPM 75 black 1 pc Installation paste</p>

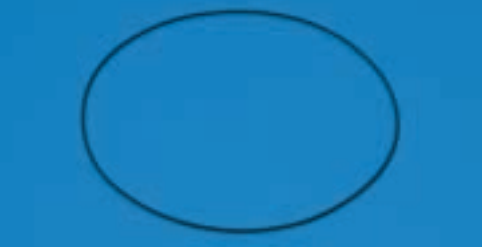
Cylinder liner sealing ring kit

dph-no.	OEM-no.	application
35810	271 181-0	 <p>TD120A Contents: 1 pc 143,50 x 1,60 FPM 75 black 1 pc 142,80 x 5,80 FPM 75 black 1 pc 142,80 x 5,80 FPM 75 purple 1 pc Installation paste</p>
36034	271 156-2	 <p>TD120C, D, E, F, FA, FB, FC, G, GA Contents: 1 pc 142,80 x 5,80 FPM 75 black 1 pc 142,80 x 5,80 FPM 75 purple 1 pc 143,50 x 1,60 FPM 75 black 1 pc Volvo 468 582-1 1 pc Installation paste</p>
35809	271 155-4	 <p>TD121F, FA, FB, FC, FD, FE, FF TD121FK, FN, G, GD up to engine -131995 Contents: 2 pc 142,80 x 5,80 FPM 75 black 1 pc 142,80 x 5,80 FPM 75 purple 1 pc 143,50 x 1,60 FPM 75 black 1 pc Installation paste</p>
46829	270 950-9	 <p>TD121FK, FN, G, GD from engine 131996- TD122F, FA, FH, FK, FL, FR, FS, TD123E, TD123ES Contents: 2 pcs 142,80 x 5,80 FPM 75 black 1 pc 142,80 x 5,80 FPM 75 purple 1 pc 140,00 x 2,50 FPM 75 black 1 pc Installation paste</p>
46830	270 935-0	 <p>D16A, TD162F, FL, FS, ES Contents: 1 pc 169,00 x 2,40 FPM 75 purple 1 pc 155,00 x 2,50 EPDM 70 2 pcs 157,60 x 5,80 FPM 75 black 1 pc 157,60 x 5,80 FPM 75 purple 1 pc Installation paste</p>
32974 95757	421 226 471 419-2	 <p>Size: 114x1,6 FPM 75 green</p>
32972 95759	422 219-6 424 594	 <p>Size: 132,5x1,6 FPM 75 green</p>

Cylinder liner sealing ring kit

dph-no.	OEM-no.	application
93250	422 713-0	Size: 132,5x2,4 FPM 75 black 
95762	424 595-7	Size: 143,5x1,6 FPM 75 black 
95754	424 830-8	Size: 108,5x5,8 FPM purple 
95756 32977	424 831-6 469 445	Size: 115,8x5,8 FPM purple 
95760	424 832-4	Size: 132,7x5,7 FPM 75 black 
94358	424 833-2	Size: 142,8x5,8 FPM 75 purple 
95755	465 906-6	Size: 108,5x5,8 FPM 75 black 

Cylinder liner sealing ring kit

dph-no.	OEM-no.	application
95758	471 424-2	Size: 115,8x5,8 FPM 75 black
95761	1 546 229-4	Size: 132,7x5,7 FPM 75 purple

Liner rings

dph-no.	OEM-no.	application
32974 95757	421 226 471 419-2	Size: 114 x 1,6 FPM 75 green
32972 95759	422 219-6 424 594	Size: 132,5 x 1,6 FPM 75 green
93250	422 713-0	Size: 132,5 x 2,4 FPM 75 black
95762	424 595-7	Size: 143,5 x 1,6 FPM 75 black
95754	424 830-8	Size: 108,5 x 5,8 FPM purple

Liner rings

dph-no.	OEM-no.	application
95756 32977	424 831-6 469 445	Size: 115,8 x 5,8 FPM purple
95760	424 832-4	Size: 132,7 x 5,7 FPM 75 black
94358	424 833-2	Size: 142,8 x 5,8 FPM 75 purple
95755	465 906-6	Size: 108,5 x 5,8 FPM 75 black
95758	471 424-2	Size: 115,8 x 5,8 FPM 75 black
95761	1 546 229-4	Size: 132,7 x 5,7 FPM 75 purple

Manifold gasket set

dph-no.	OEM-no.	application
36560	270 766-9	D50A, D50B, TD50A, TD50B, TD60A* *for F84, F85

Manifold gasket set

dph-no.	OEM-no.	application
36563	270 769-3	D60A*, TD60A * *for B6, F6
36565	270 768-5	TD60A*, TD60B, TD60C *for F65
36566	270 764-4	TD61F, TD61FB, TD61FBQ, TD61FHQ, TD61G, TD61GA, TD61GB, TD61GC, TD61GE, TD61GS, TD63E, TD63ES, D6A
36506	270 771-9	D70A, D70B, TD70A, TD70B, TD70C, TD70D, TD70E, TD70F, TD70FC, TD70FS, TD70G, TD70H, TD70HA
36297	270 765-1	TD71F, TD71FA, TD71FAQ, TD71FC, TD71FCQ, TD71FD, TD71FQ, TD71FS, TD71FSQ, TD71G
36508	270 958-2	D100A, D100B, TD100A, TD100B, TD100BG, TD100C THD100A, THD100D, THD100DA, THD100DB, THD100DC, THD100DD
36509	276 052-8	TD100G, TD100GA, THD100EA, THD100EB, THD100EC, THD100ED, THD100EE, THD100EK TD101, THD101, TD102, TD103; THD102, THD103, THD103, THD104

Manifold gasket set

dph-no.	OEM-no.	application
36507	270 772-7	 <p>TD120, TD121, TD122, TD123</p>
36509	276 052-8	 <p>TD100G, TD100GA, THD100EA, THD100EB, THD100EC, THD100ED, THD100EE, THD100EK TD101, THD101, TD102, THD102, TD103, THD103, THD104</p>

Turbo connection gasket set

dph-no.	OEM-no.	application
70116	270 751-1	 <p>TD41G</p>
84305	276 815-6	 <p>TD100G, TD100GA, THD100D*, THD100DA*, THD100DB*, THD100DC*, THD100DD*, THD100E all, THD101F, TD101FA, TD101FC, TD101FD, TD101G, TD101GA, TD101GB, THD101GB, THD101GC, THD101GD, THD 101KB, THD101KC, THD101KD, THD101KE, THD101KF, TD102, THD102, TD103, THD103, THD104KB, THD104KF, D10A * from engine no. 23199-</p>
36036	270 997-0	 <p>TD100A* TD100B*, TD100BG* TD100C, TD120A**, TD120E**, TD120G**, TD120GA** * excl. F10, ** for N12</p>
70112	271 089-5	 <p>TD162F, TD162FL, TD162FS, TD163ES</p>

Gasket set complete engine overhaul



dph-no.	OEM-no.	application
37574 FS-500	2 x 275 740-9 270 770-1 270 779-2 270 766-9 6 x 275 460-4	D50A, D50B, TD50A, TD50B
37575 FS-600	2x 275 740-9 270 770-1 270 779-2 270 766-9 6 x 271 162-0	TD60A, F84, F85
70428 FS-601	2 x 275 740-9 270 770-1 270 779-2 270 769-3 6x 271 162-0	D60A/TD60A, B6, F6
70429 FS-602	2x 275 740-9 270 770-1 270 779-2 270 768-5 6x 271 162-0	TD60A, F6S
61453 FS-603	2x 275 740-9 270 762-8 270 778-4 270 768-5 6x 271 162-0	TD60B, TD60C
51259 FS-610	2x 276 821-6 275 776-3 270 774-3 270 764-4 6x 271 161-2	TD61F, TD61FB, TD61FBQ, TD61FHQ, TD61G, TD61GA, TD61GB, TD61GC, TD61GE, TD61GS

Gasket set complete engine overhaul

dph-no.	OEM-no.	application
37576 FS-700	2x 275 525-4 270 761-0 270 957-4 270 771-9 6x 271 160-4	D70A, D70B, TD70A, TD70B, TD70D, TD70E, TD70H*, TD70HA* *for B57, BB57
48694 FS-701	2x 275 525-4 270 761-0 270 777-6 270 771-9 6x 271 160-4	TD70F, TD70FC, TD70FS, TD70G, TD70H* *for B7F, B7FA
48072 FS-710	2x 276 816-6 275 781-3 270 775-0 270 765-1 6x 271 159-6	TD71F, TD71FA, TD71FAQ, TD71FC, TD71FCQ, TD71FD, TD71FS, TD71G
37482 FS-1000	6x 275 551-0 276 034-6 276 122-9 270 958-2 6x 271 158-8	D100A, D100B, TD100A, TD100B, TD100C from engine 18536-
4550 FS-1001	6x 270 789-1 276 034-6 276 122-9 270 958-2 6x 271 158-8	TD100BG
37483 FS-1003	6x 270 789-1 276 035-3 276 122-9 276 052-8 6x 271 158-8	TD100G, TD100GA, TD101F*, TD101FA*, TD101G* TD101GA, GB not for FL10 *up to engine -199157
70293 FS-1011	6x 270 789-1 276 035-3 276 122-9 276 052-8 6x 271 157-0	TD101F*, TD101FA*, TD101G*, *from engine 199158- Not for FL10 TD101GA, TD101GB
70294 FS-1012	6 x 270 789-1 276 035-3 276 123-7 276 052-8 6x 271 158-8	TD101F, TD101FA, TD101G up to engine -199157 for FL10 TD101FC, FD
70295 FS-1013	6x 270 789-1 276 035-3 276 123-7 276 052-8 6x 271 157-0	TD101F, TD101FA from engine 199158- for FL10 TD101FC, TD101FD TD102F, TD102FD, TD102FDQ, TD102FF, TD102FH, TD102FQ, TD102FS Not for engines with plastic laminate oil pan
70423 FS-2000	6x 275 551-0 275 533-8 270 782-6 270 958-2 6x 271 158-8	HD100A, HD100D, THD100A, THD100D, THD100DA, THD100DB, THD100DC, THD100DD from engine 2499 up to 23198
48346 FS-2001	6x 275 551-0 275 741-7 270 782-6 270 958-2 6x 271 158-8	THD100D, THD100DA, THD100DB, THD100DC, THD100DD from engine 23199-

Gasket set complete engine overhaul

dph-no.	OEM-no.	application
48347 FS-2002	6x 270 789-1 275 741-7 270 782-6 276 052-2 6x 271 158-8	THD100EA, THD100EB, THD100EC, THD100ED, THD100EE, THD100EK
48071 FS-2010	6x 270 789-1 275 741-7 275 785-4 276 052-8 6x 271 158-8	THD101GB, THD101GC, THD101GD, THD101GK, THD101KB, THD101KC, THD101KD, THD101KE, THD101KF up to engine no. -40891
70424 FS-2011	6x 270 789-1 275 741-7 275 785-4 276 052-8 6x 271 157-0	THD101*, THD102KA, THD102KB, THD102KD, THD102KE, THD102KF** THD103KB, THD102KD, THD103KF THD104KB, THD104KF *from engine 40892- **not for B10R
37577 FS-2200	6x 275 548-6 275 554-4 276 124-5 270 772-7 6x 271 181-0	TD120A
37484 FS-2201	6x 275 548-6 275 554-4 276 124-5 270 772-7 6x 271 156-2	TD120C, TD120D, TD120E, TD120F, TD120FA, TD120FB, TD120FC, TD120G, TD120GA up to engine -55607
48348 FS-2202	6x 275 548-6 275 554-4 275 124-5 270 772-7 6x 271 156-2	TD120E, TD120F, TD120FA, TD120FB, TD120FC, TD120G, TD120GA from engine 55608-
46779 FS-2210	6x 275 548-6 275 554-4 275 124-5 270 772-7 6x 271 155-4	TD121F, TD121FA, TD121FB, TD121FC, TD121FD, TD121FF, TD121FK, TD121G*, TD121GD* up to engine -131995
70296 FS-2212	6x 275 548-6 275 554-4 275 124-5 270 772-7 6x 270 950-9	TD121G*, TD121GD*, TD122 *from engine 131996- Not for engines with plastic laminate oil pan

Gasket set complete engine overhaul without liner sealing rings



dph-no.	OEM-no.	application
37485 FS-1500	2 x 275 740-9 270 770-1 270 779-2 270 766-9	D50A, D50B, TD50A, TD50B, TD60A, F84, F85
70421 FS-1601	2 x 275 740-9 270 770-1 270 779-2 270 769-3	D60A, TD60A, B6, F6
70422 FS-1602	2x 275 740-9 270 770-1 270 779-2 270 768-5	TD60A, F6S
70297 FS-1603	2x 275 740-9 270 762-8 270 778-4 270 768-5	TD60B, TD60C
48854 FS-1610	2x 276 821-6 275 776-3 270 774-3 270 764-4	TD61F, TD61FB, TD61FBQ, TD61FHQ, TD61G, TD61GA, TD61GB, TD61GC, TD61GE, TD61GS
37486 FS-1700	2x 275 525-4 270 761-0 270 957-4 270 771-9	D70A, D70B, TD70A, TD70B, TD70D, TD70E, TD70H*, TD70HA* *for B57, BB57
48695 FS-1701	2x 275 525-4 270 761-0 270 777-6 270 771-9	TD70F, TD70FC, TD70FS, TD70G, TD70H*, HA* *for B7F, B7FA
48855 FS-1710	2x 276 816-6 275 781-3 270 775-0 270 765-1	TD71F, TD71FA, TD71FAQ, TD71FC, TD71FCQ, TD71FD, TD71FS, TD71G

Gasket set complete engine overhaul without liner sealing rings

dph-no.	OEM-no.	application
37578 FS-11000	6x 275 551-0 276 034-6 276 122-9 270 958-2	D100A, D100B, TD100A, TD100B, TD100C from engine 18536-
4513 FS-11001	6x 270 789-1 276 034-6 276 122-9 270 958-2	TD100BG
37066 FS-11003	6x 270 789-1 276 035-3 276 122-9 276 052-8	TD100G, TD100GA, TD101GA, TD101GB TD101F*, TD101FA*, TD101G*, TD101GA, TD101GB *not for FL10
46777 FS-11011	6x 270 789-1 276 035-3 276 123-7 276 052-8	TD101FC, TD101FD, TD101F FL10, TD101FA FL10, TD102FF, TD102FH, TD102FQ, TD102FS, TD101G FL10, THD102, TD102FD, TD102FDQ Not for engines with plastic laminate oil pan
70420 FS-12000	6x 275 551-0 275 533-8 270 782-6 270 958-2	HD100A, HD100D, THD100A, THD100D, THD100DA, THD100DB, THD100DC, THD100DD from engine 2499 up to 23198
70426 FS-22001	6x 275 551-0 275 741-7 270 782-6 270 958-2	THD100D, THD100DA, THD100DB, THD100DC, THD100DD from engine 23199-
70302 FS-22202	6x 270 789-1 275 741-7 270 782-6 276 052-8	THD100EA, THD100EB, THD100EC, THD100ED, THD100EE, THD100EK
48856 FS-22010	6x 270 789-1 275 741-7 275 785-4 276 052-8	THD101GB, THD101GC, THD101GD, THD101GK, THD101KB, THD101KC, THD101KD, THD101KE, THD101KF THD102KA, THD102KB, THD102KD, THD102KE THD102KF not for B10R THD103KB, THD103KD, THD103KF, THD104KB, THD104KF
70427 FS-22012	6x 270 789-1 275 741-7 276 095-7 276 052-8	THD102KF, B10R
37579 FS-22200	6x 270 548-6 275 554-4 276 124-5 270 772-7	TD120A, TD120C, TD120D, TD120E, TD120F, TD120FA, TD120FB, TD120FC, TD120G, TD120GA up to engine -55607
37580 FS-22202	6x 275 548-6 275 554-4 276 124-5 270 772-7	TD120E, TD120F, TD120FA, TD120FB, TD120FC, TD120G, TD120GA from engine 55608- TD121F, TD121FA, TD121FB, TD121FC, TD121FD, TD121FE, TD121FF, TD121FK, TD121FN, TD121G*, TD121GD* *up to engine -131995
51036 FS-22212	6x 270 949-1 275 554-4 276 125-2 270 772-7	TD121G*, TD121GD*, TD122 *from engine no. 131996- Not for engines with plastic laminate oil pan

Decarbonizing gasket set

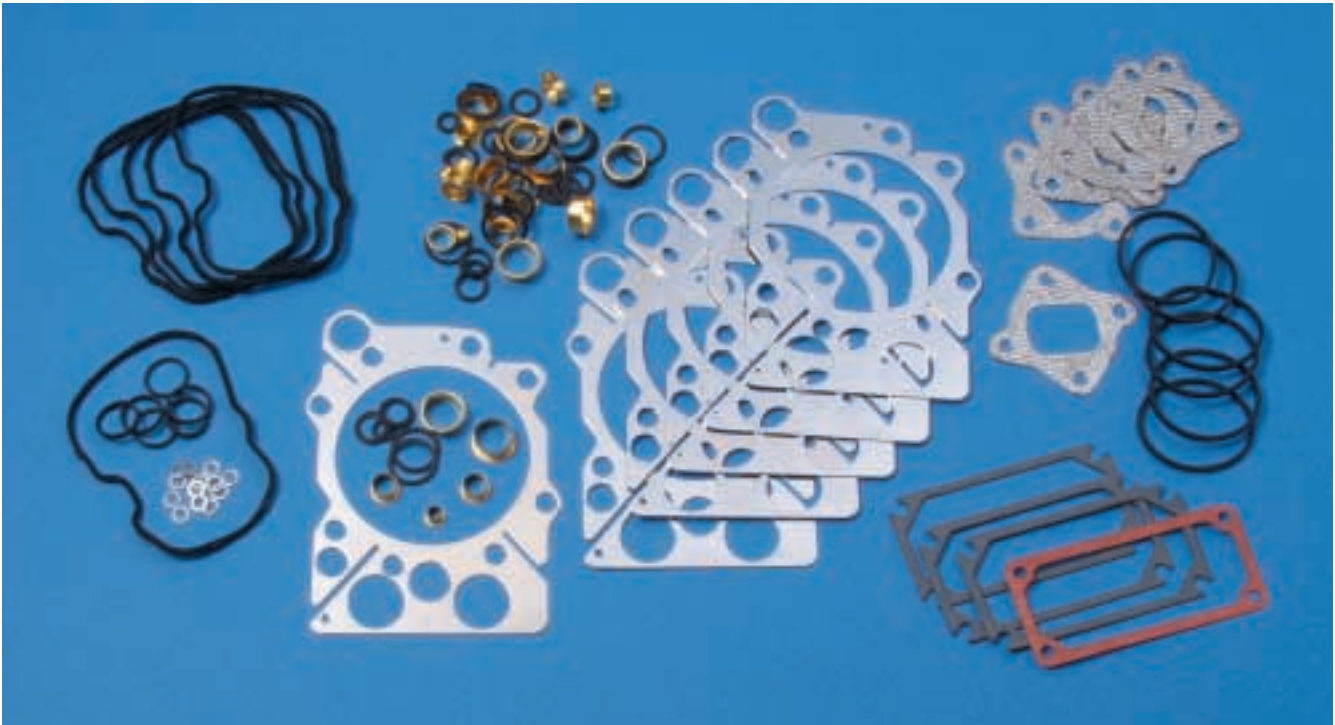

dph-no.	OEM-no.	application
37581 HS-5000	2x 275 740-9 270 770-1 270 766-9	D50A, D50B TD50A, TD50B TD60A F84, 85
81826 HS-6001	2x 275 740-9 270 770-1 270 769-3	D60A/TD60A B6, F6
81827 HS-6002	2x 275 740-9 270 770-1 270 768-5	TD60A F6S
51260 HS-6003	2x 275 740-9 270 762-8 270 768-5	TD60B, TD60C
4245 HS-6010	2 x 276 821-6 275 776-3 270 764-4	TD61F, TD61FB, TD61FBQ, TD61FHQ, TD61G, TD61GA, TD61GB, TD61GC, TD61GE, TD61GS, TD61E, TD61ES TD63E, TD63ES
37064 HS-7000	2x 275 525-4 270 761-0 270 771-9	D70A, D70B TD70A, TD70B, TD70C, TD70D, TD70E, TD70F, TD70FC, TD70FS, TD70G, TD70H, TD70HA
37062 HS-7010	2x 276 816-6 275 781-3 270 765-1	TD71F, TD71FA, TD71FAQ, TD71FC, TD71FCQ, TD71FD, TD71FQ, TD71FS, TD71FSQ, TD71G

Decarbonizing gasket set

dph-no.	OEM-no.	application
37582 HS-8000	6x 275 551-0 276 034-6 270 958-2	D100A, D100B, TD100A, TD100B, TD100C from engine 18536- up to -145715
6452 HS-8001	6x 270 789-1 276 034-6 270 958-2	TD100BG
81825 HS-8002	6x 275 551-0 276 035-3 270 958-2	TD100C from engine 145716-
37063 HS-8003	6x 270 789-1 276 035-3 276 052-8	TD100G, TD100GA, TD101F, TD101FA, TD101FC, TD101FD, TD101G, TD101GA, TD101GB, TD102F, TD102FD, TD102FDQ, TD102FF, TD102FH, TD102FL, TD102FM, TD102FQ, TD102FS TD103E, TD103ES
81824 HS-8004	6 x 275 551-0 275 533-8 270 958-2	HD100A, HD100D, THD100A, THD100D, THD100DA, THD100DB, THD100DC, THD100DD from engine 2499- up to -23198
48779 HS-8005	6 x 275 551-0 275 741-7 276 052-8	THD100D, THD100DA, THD100DB, THD100DC, THD100DD from engine 23199-
46778 HS-8006	6x 270 789-1 275 741-7 276 052-8	THD100EA, THD100EB, THD100EC, THD100ED, THD100EE, THD100EK, THD101, THD102, THD103, THD104, DH10A
37583 HS-9000	6x 275 548-6 275 554-4 270 772-7	TD120A, TD120C, TD120D, TD120E, TD120F, TD120FA, TD120FB, TD120FC, TD120G, TD120GA, TD121F, TD121FA, TD121FB, TD121FC, TD121FD, TD121FE, TD121FF, TD121FK, TD121FN, TD121G*, TD121GD* *up to engine -131995
61338 HS-9001	6x 270 949-1 275 554-4 270 772-7	TD122F, TD122FA, TD122FH, TD122FK, TD122FL, TD122FR, TD122FS, TD123E, TD123ES, TD121G*, TD121GD* *from engine 131996-

Water seal cylinder

dph-no.	OEM-no.	application
556	479 260-2	D100A, D100B, TD100, TD101, TD102, TD103, D10A IMPORTANT!!! Use installation paste when fitting the seal. Do not use grease or oil.



Installation paste

dph-no.	OEM-no.	application
37092	1 696 135-8	For water seal cylinder head 479260-2 and cylinder liner sealing ring kits



Rubber seal

dph-no.	OEM-no.	application
69924	471 956-3	For pipe oil filter housing-oil cooler to: TD61, TD63, TD71, TD73 Size: 17x25,7x7,3 FPM 70



Gasket for plugs to cylinder block

dph-no.	OEM-no.	application
49002	469 327-1	For plugs ref.Nr.: 46365-3 1 1/2" and 467367-9 1 3/4" 469327-1 for cylinder head: D100, TD100-103, HD100, THD100-104, TD120-123, TD162-163, D10A, DH10A 469328-9 for cylinder head: D50, TD50, D60, TD60, D70, TD70 469328-9 for cylinder block: D50, TD50, D60, TD60, TD61, TD63, D70, TD70, TD71, 73, D100, TD100-103, HD100, THD100-104, TD120-123, D10A, DH10A
49003	469 328-9	

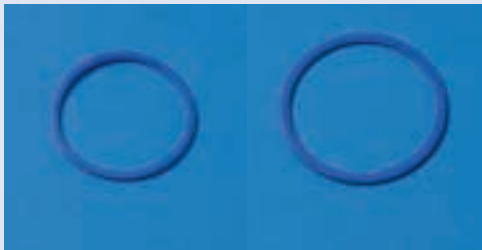





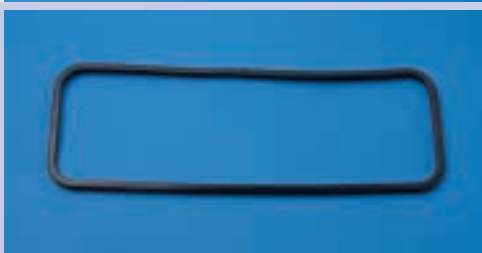

Valve cover gasket

dph-no.	OEM-no.	application
35985	420 066-3	D50A, D50B, TD50A, TD50B, D60A, TD60A, TD60B, TD60C
46747	465 952-0	TD61F, TD61FB, TD61FBQ, TD61FHQ, TD61G, TD61GA, TD61GB, TD61GE, TD61GS, TD63E, TD63ES



Valve cover gasket

dph-no.	OEM-no.		application
32919	421 066-2		D70A, D70B, TD70A, TD70B, TD70C, TD70D, TD70E, TD70F, TD70FC, TD70FS, TD70G, TD70H, TD70HA
46748	471 520-7		TD71F, TD71FA, TD71FAQ, TD71FC, TD71FCQ, TD71FD, TD71FQ, TD71FS, TD71FSQ, TD71G, TD73E, TD73ES
32918	423 146-0		UPPER GASKET D100A, D100B, TD100A, TD100B, TD100C up to engine -145715 HD100A, HD100D, THD100A, THD100D, THD100DA, THD100DB, THD100DC, THD100DD up to engine -23198 B58BR THD100D up to -1554
32981	423 145-2		LOWER GASKET D100A, D100B, TD100A, TD100B, TD100C up to engine -145715 HD100A, HD100D, THD100A, THD100D, THD100DA, THD100DB, THD100DC, THD100DD up to engine -23198 B58BR THD100D up to -1554
35781	424 694-8		UPPER GASKET TD100C from engine 145716- TD100G, TD100GA, TD101, TD102, TD103, THD100D*, THD100DA*, THD100DB*, THD100DC*, THD100DD* *from engine 23199- B58BR THD100D from 1555- THD101, TD101, THD101, TD 102, THD102, TD103, THD103, THD104KB, THD104KF, D10A, DH10A
35735	424 693-0		LOWER GASKET TD100C from engine 145716- TD100G, TD100GA, TD101, TD102, TD103, THD100D*, THD100DA*, THD100DB*, THD100DD*, HD100DC* *from engine 23199- B58BR ZHD100D from 1555- THD101, TD101, TD102, THD103, TD103, THD103, THD104KB, THD104KF, D10A, DH10A
36032	424 692-2		TD120, TD121, TD122, TD123







Gasket inspection cover cylinder block

dph-no.	OEM-no.	application
48512	421 121-5	D50, TD50, D60, TD60, TD61, TD63, D70, TD70, TD71, TD73, D6A, D7A, D7B
48073	469 823-9	D100, TD100, TD101, TD102, TD103, TD120, TD121, TD122, TD123, HD100*, THD100*, THD101*, THD102*, THD103*, THD104KB*, TH104KF*, D10A, DH10A *also for oil collector housing

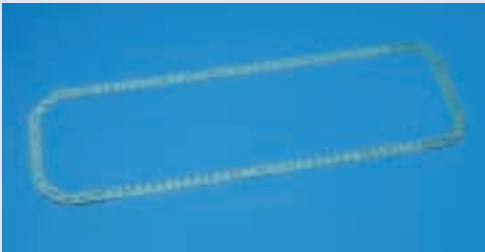
Oil pan gasket

dph-no.	OEM-no.	application
4649	424 600-5	D50A, D50B, TD50A, TD50B, D60A, TD60A, TD60B, TD60C, TD61F, TD61FB, TD61FBQ, TD61G, TD61GA, TD61GB, TD61GE, TD61GS Not for engines with plastic laminate oil pan 4-part gasket
84384	424 601-3	D70A, D70B, TD70A, TD70B, TD70C, TD70D, TD70E, TD70F, TD70FC, TD70FS, TD70G, TD70H, TD70HA, TD71F, TD71FA, TD71FAQ, TD71FC, TD71FCQ, TD71FD, TD71FS, TD71G Not for engines with plastic laminate oil pan
4514	424 602-1	TD100G, TD100GA, TD101F, TD101FA, TD101FC, TD101FD, TD101GA, TD101GB, TD102F, TD102FD, TD102FDQ, TD102FF, TD102FH, TD102FQ, TD102FDS Not for engines with plastic laminate oil pan 4-part gasket
80359	424 603-9	TD120A, TD120C, TD120D, TD120E, TD120F, TD120FA, TD120FB, TD120FC from engine 55608- TD120G, TD120GA, TD121F, TD121FA, TD121FB, TD121FC, TD121FD, TD121FE, TD121FF, TD121FK, TD121G, TD121GD, TD122* Not for engines with plastic laminate oil pan 4-part gasket
37491	424 918-1	

Oil pan gasket

dph-no.	OEM-no.		application
70392 36512	424 919-1 421 025-8		D70A, D70B, TD70A, TD70B, TD70C, TD70D, TD70E, TD70F, TD70FC, TD70FS, TD70G, TD70H, TD70HA, TD71F, TD71FA, TD71FAQ, TD71FC, TD71FCQ, TD71FD, TD71FS, TD71G Not for engines with plastic laminate oil pan
36514 36946	478 505-1 424 605-4		TD120A, TD120C, TD120D, TD120E, TD120F, TD120FA, TD120FB, TD120FC up to engine -55607
36045 4514 37492	479 264-4 424 602-1 424 604-7		D100A, D100B TD100A, TD100B, TD100BG, TD100C 4-part gasket
37586	424 607-0		UPPER GASKET HD100A, HD100D, THD100A, THD100DB, THD100DC, THD100DD, THD100EA, THD100EB, THD100EC, THD100ED, THD100EE, THD100EK, THD102, B10R
37587	424 276-4		LOWER GASKET HD100A, HD100D, THD100A, DB, DC, DD, EA, EB, EC, ED, EE, EK, THD102K B10R
81683	420 941-7		TD73E, TD63ES, D6A For engines with plastic laminate oil pan Rubber gasket
81686	479 484-8		TD122, TD123E, TD123ES For engines with plastic laminate oil pan – 4-part gasket Rubber gasket

Oil pan gasket

dph-no.	OEM-no.	application
81685	479 486-3	TD102, TD103E, TD103EA, TD103ES, D10A For engines with plastic laminate oil pan – rubber gasket Rubber gasket



Rubber seal oil filter cap

dph-no.	OEM-no.	application
69766	940 096-1	TD40A, TD41G, D50, TD50, D60, TD60, TD61, TD63, D70, TD70, TD71, TD73, D100, TD100, THD100, TD101, THD101, TD102, THD102, TD103, THD103, THD104, TD120, TD121, TD122, TD123, TD162, TD163, D6A, D7A, D7B, D10A, DH10A Size: 42x57x3 NBR 70



Rubber gasket oil filter housing

dph-no.	OEM-no.	application
35737	469 484-0	TD100A engine no. 62343 –132654, TD100B engine no. 62343-132461
61482	469 487-3	TD100A engine no. 132655- TD100B engine no. 132462- TD100C, TD100G, TD100GA, TD101, TD102, TD103
61481	469 486-5	TD120 excl. TD120A, TD121, TD122, TD123





Rubber gasket oil cooler

dph-no.	OEM-no.	application
51329	471 465-5	TD70B, TD70E, TD70F, TD70FC, TD70FS, TD70G



Gasket exhaust manifold

dph-no.	OEM-no.	application
37588	420 708-0	D50A, D50B, TD50A, TD50B, D60A, TD60A, TD60B, TD60C
69851	420 538-1	TD61F, TD61FB, TD61FBQ, TD61FHQ, TD61G, TD61GA, TD61GB, TD61GE, TD61GS, TD63E, TD63ES, D6A
36717	421 534-9	D70A, D70B, TD70A, TD70B, TD70C, TD70D, TD70E, TD70F, TD70FC, TD70FS, TD70G, TD70H, TD70HA
36718	471 650-2	TD71F, TD71FA, TD71FAQ, TD71FC, TD71FCQ, TD71FD, TD71FQ, TD71FS, TD71FSQ, TD71G, TD73E, TD73ES, D7A, D7B
37493	424 634-4	D100A, D100B, TD100A, TD100B, TD100BG, TD100C, THD100A, THD100D, THD100DA, THD100DB, THD100DC, THD100DD
48687	479 107-5	TD100G, TD100GA, THD100EA, THD100EB, THD100C, THD100ED, THD100EE, THD100EK, TD101, THD101, TD102, THD102, TD103, THD103, THD104KB, THD104KF, D10A, DH10A
37548	470 534-9	TD120, TD121, TD122, TD123

Gasket intake manifold

dph-no.	OEM-no.		application
81982	424 610-4		D50A, D50B, TD50A, TD50B TD60A for F84, F85
77238	424 611-2		D60A, TD60B, TD60C TD60A excl. F84, F85
50326	424 612-0		D70A, D70B, TD70A, TD70B, TD70C, TD70D, TD70E, TD70F, TD70FC, TD70FS, TD70G, TD70H, TD70HA
69895	469 661-3		THD101 THD102, THD103, THD104KB, THD104KF, DH10A For intake manifold-intercooler
69897	469 662-1		THD101 THD102, THD103, THD104KB, THD104KF, DH10A For connecting pipe-intake manifold
50588	469 829-6		Rubber ring D100, HD100, TD100, THD100, TD101, THD101, TD102, THD102, TD103, THD103, THD104
50616	423 174-2		Rubber ring TD120, TD121, TD122, TD123 Size: 78,5x85,5x4,5 NBR 70

Gasket timing gear casing cover

dph-no.	OEM-no.	application
36044	469 259-6	HD100A, HD100D, THD100A for engines with servo pump take-off transmission THD100D, THD100DA, THD100DB, THD100DC, THD100DD up to engine no. -21019
36042	468 116-9	TD 101/102
36041	467 177-2	TD 101/102

Rubber seal oil cooler

dph-no.	OEM-no.	application
69830	471 467-1	TD71, TD73, D7A, D7B Size: 48x63x7,4 FPM 70

Rubber seal oil cooler pipe

dph-no.	OEM-no.	application
69884	471 637-9	D6A, TD71, TD73, D7A, D7B Size: 25x33,5x7 NBR 70

Felt ring crankshaft front sealing

dph-no.	OEM-no.	application
4053	421 131-4	D50A, D50B, TD50A, TD50B, D60A, TD60A, TD60B, TD60C, D70A, D70B, TD70A, TD70B, TD70C, TD70D, TD70E, TD70F, TD70FC, TD70FS, TD70G, TD70H, TD70HA

Felt ring crankshaft front sealing

dph-no.	OEM-no.	application
36299	942 083-7	TD61, TD71
37205	422 146-1	D100A, TD100B, TD100A, TD100B, TD100BG, TD100C, TD100G, TD100GA, TD101F for engine -168545, TD101G for engine-174866, TD120A, TD120C, TD120D, TD120E, TD120F, TD120FA, TD120FB, TD120FC, TD120G, TD120GA, TD121 for engine -91925
36719	941 666-0	HD100, THD100

Felt ring crankshaft rear sealing

dph-no.	OEM-no.	application
4054	421 147-0	D50A, D50B, TD50A, TD50B, D60A, TD60A, TD61, TD63, D70A, D70B, TD70A, TD70B, TD70C, TD70D, TD70E, TD70H, TD70HA
46803	422 145-3	D100A, D100B, TD100A, TD100B up to engine -58275, TD120A up to engine -13193

O-Ring oil cooler



dph-no.	OEM-no.	application
50607	944 988-5	TD70B, TD70E, TD70F, TD70FC, TD70FS, TD70G 2 Pcs required Size: 17x4,5 NBR 70

O-Ring oil cooler

dph-no.	OEM-no.	application
32927	949 656-3	 <p>TD70B, TD70E, TD70F, TD70FC, TD70FS, TD70G 2 Pcs required For oil filter housing to: D60, TD60, TD61, TD63, TD71, TD73, D7A, D7B Size: 19x3 FPM 80</p>
70050	943 177-6	 <p>TD70B, TD70E, TD70F, TD70FC, TD70FS, TD70G up to engine No. -155 993 8 Pcs required Size: 15,3x2,4 FPM 80</p>

Engine parts, fuel, exhaust and cooling system parts

Oil seal crankshaft front sealing

dph-no.	OEM-no.	application
82787	477 118-4 MVQ ARD	 <p>TD61F, TD61FB, TD61FBQ, TD61FHQ, TD61G, TD61GA, TD61GB, TD61GE, TD61GS, TD63E, TD63ES, TD71F, TD71FA, TD71FAQ, TD71FC, TD71FCQ, TD71FD, TD71FQ, TD71FS, TD71FSQ, TD71G, TD73E, TD73ES, D6A, D7A, D7B Size: 76,2x101,6x11,9</p>
110485	447 7118-4 FPM A/BS RD	
37211	424 983-5 FPM A/BS RD W	 <p>TD100BG, TD100C, TD100G, TD100GA, HD100, THD100, TD101F from engine 168546-, TD101G from engine 174867- THD101, TD102, THD102, TD103E, EA, ES, THD103, THD104KB, KF TD121 from engine 91926-, TD122, TD123E, TD123ES, D10A Size: 85,73x114,33x13/9,5</p>
110473	424 983-5 MVQ AS W RD	
97594	424 763-1	 <p>THD102, THD103, THD104, TH10A, DH10A Size: 130x160x15 FPM AW/BS RD</p>

Oil seal crankshaft rear sealing

dph-no.	OEM-no.	application
36586	477 119-2 MVQ ALD	 <p>TD60A, F6S, TD60B, TD60C, TD61F, TD61FB, TD61FBQ, TD61FHQ, TD61G, TD61GA, TD61GB, TD61GE, TD61GS, TD63E, TD63ES, TD71F, TD71FA, TD71FAQ, TD71FC, TD71FCQ, TD71FD, TD71FQ, TD71FS, TD71FSQ, TD71G, TD73E, TD73ES, D6A, D7A, D7B Size: 127x150x12</p>
110486	477 119-2 FPM A/BS LD	
15252	469 336-2	 <p>D100A, B, TD100A, TD100B from engine 58276-, TD100BG, TD100C, D100G, TD100GA, HD100, THD100, TD101, THD101, TD102, THD102, TD103E, TD103EA, TD103ES, THD103, THD104KB, THD104KF, TD120A from engine 13194-, TD120C, TD120D, TD120E, TD120F, TD120A, TD120FB, TD120FC, TD120G, TD120GA, TD122, TD123E, TD123ES, D10A, DH10A Size: 155x180x15 FPM A/BS LDW</p>

Oil seal



dph-no.	OEM-no.	application
95873	1 139 840-1	Size: 85x105x12/10 blue dph B NBR
94318	1 070 379-1	Size: 100x120x12 A/BS WD FPM dph
95875	1 190 064-4	Size: 85x105x10 B LD FPM dph
81507	1 518 399	Size: 22,23x35,15x9,52 AS FPM dph
95892	1 522 896	Size: 150x180x17,50/16
95354	1 523 239	Size: 90x145x10/15 A/B SP FPM dph
95878	1 526 688-5	Size: 55x75x8
94314	1 593 459-9	Size: 100x140x17 SP FPM dph
94319	1 594 257-6	Size: 145x175x17 SP FPM dph
94048	1 669 618	Size: 90x110x11/9,5 AW/BS LD FPM dph
50742	231 938-2	Size: 130x160x15 AS MVQ LD dph
81848	240 022	Size: 25x35x7 blue AS NBR dph
81330	247 597-7	Size: 117,47x152,4x11,51 spezial dph
93291	3 123 521-1	Size: 145x172x19 NBR spezial dph



Oil seal

dph-no.	OEM-no.	application
4293	3 514 943	Size: 30x47x7 A SP NBR dph
96085	346 822-0	Size: 10x15x13 B OF NBR
94315	6 771 541-7	Size: 135x165x17 CS spezial dph FPM
95884	6 876 142-8	Size: 25x35x7 B NBR dph
80413		Size: 98x110,70x6,8 ASW MVQ
81186		Size: 55x73x8,5/7,5 black B SP NBR dph
82246		Size: 28x38x9/11 ASW FPM dph
82425	1 587 792-1	Size: 110x140x21,5 SP NBR dph
46809	1 089 552-2	Size: 110x140x12/21,5 NBR WD spezial dph
82985		Size: 22x32x9/11 AS W FPM dph
84162	1 695 593	Size: 20x40x8 A SP FPM
94037		Size: 25x41,3x10 A SP NBR blue dph
81414	946 093-2	Size: 125x150x13 BS NBR
94036	948 826-3	Size: 68x80x8 B RD LA FPM dph
69527	949 573	Size: 44x58x7 B NBR blue dph
93784	958 861-7	Size: 38x52x7 NBR A
36318	821 755-6	Size: 155x180x15
15252	469 336-2	FPM A/BS LD W dph
98639	241 625	Size: 16x30x7 AS NBR

Thermostat seal

dph-no.	OEM-no.	application
32184	416 033-9 1 317 466-9	 <p>TD40A, TD41G, TD50, D60, TD60, D70, TD70A, TD70B, TD70C, TD70D, TD70E, TD70F*, TD70FC*, TD70FS*, TD70G*, TD70H, TD70HA, D100, TD100, HD100, THD100, TD120 *up to engine -153800 Also for intercooler thermostat to: THD101, THD 102, THD103* *up to engine -61587</p>

Thermostat seal

dph-no.	OEM-no.	application
69821	1 544 410-2	 TD70F*, TD70FC*, TD70FS*, TD70G*, *from engine 153801-, TD61, TD63, TD71, TD73, TD101, THD101, TD102, TD103, THD103, THD104KB, THD104KF, TD121, TD122, TD123, TD162, TD163, D16A, D6A, D7A, D7B, D10A, DH10A UPPER seal
82269	471 788-0	 Seal thermostat housing TD61F, TD61FB, TD61FBQ, TD61FHQ, TD61G, TD61GA, TD61GB, TD61GC, TD61GE, TD61GS, TD63E, TD63ES, TD71F, TD71FA, TD71FAQ, TD71FC, TD71FCQ, TD71FD, TD71FQ, TD71FS, TD71FSQ, TD71G, TD71E, TD72ES, TD73ES, D6A, D7A, D7B

Sealing ring coolant pump

dph-no.	OEM-no.	application
94044	958 811-2	 FL6, FL7, FS7, F10, F12, FH12, F16, FH16, N10, NL10S, N12, NL12S, B6, B10B, B10L, B10M, B58 Size: 15x35x7 NBR A W blue

Sealing ring

dph-no.	OEM-no.	application
51880	471449-9	 FL10, FL616, FL617, FL618, FL619,, FL609, FL610, FL611, FL612, FL613, FL614.(CH 314000 -), F12 (CH 314000 -) Size: 52x8 MVQ 60 red
69803	1 542 783-4	 FL10, FL10 (CH 25001 -), F12, F16, N12, B10, B12 Size: 71x7 MVQ 70 red
81985	469 908-8	 B10, B58 Material: FPM

Sealing ring/Valve stem seal

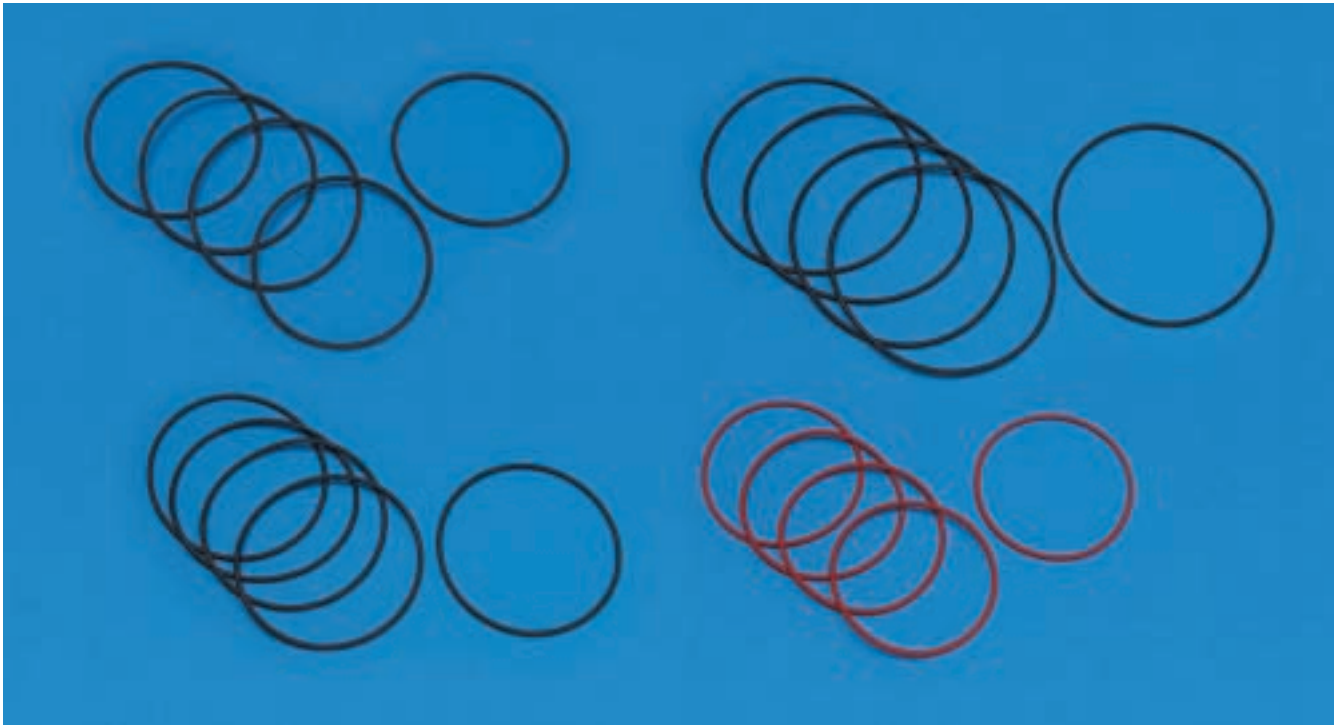

dph-no.	OEM-no.	application
95914	1 075 725	
50589	1 664 473-4	Size: 60x3 EPDM 70 OR 473
70046	190 418-4	Size: 13x3 NBR 70 OR 065
70236	466 739-0	Size: 40x7 MVQ OR 739
70239	466 740-8	Size: 48x7 MVQ 60 red OR 740
36387	846 937	
50647	925 069-7	Size: 45x3 NBR 70 engine
70048	925 092-9	Size: 54x3 NBR 70 engine
70049	925 095-2	Size: 84x3 NBR water pump
70052	925 259-4	Size: 99,5x3 NBR engine
81988	925 266	Size: 139,5x3 NBR 70 water pump
70047	942 089-4	Size: 21x3 NBR 70
81989	946 773	Size: 52x3 NBR
93807	948 254	Size: 34x3 FPM 80

● Sealing ring/Valve stem seal

dph-no.	OEM-no.	application
93396	948 983-2	Size: 125x3 FPM purple
70241	948 610-1	Size: 39,5x3 FPM 80
70055	949 657-1	Size: 22,2x3 FPM 80 OR 657
70232	949 721-5	Size: 26,2x3 FPM 80 OR 721 turbo
33570	960 218-6	Size: 19x1,5 NBR 90 OR 218
81993	977 176	Size: 12,37x2,62 FPM 80
32047	415 424-1	
50646	469 508-6	Size: 64x7 MVQ 70 red
51114	469 509-4	Size: 57x7 MVQ 60 red
82242	469 668-8	Size: 38x5 FPM 80
70007	477 059-0	Size: 44,2x5,7 EPDM
32982	469 456-8	
94042	1 526 181	Size: 28x 35x4 NBR
94555	1 526 439	Size: 60x80x2 NBR
70046	190 418-4	Size: 13x3,1 NBR
70005	925 053-1	Size: 8x2,4 NBR
70053	925 059-8	Size: 44,2x5,7 NBR
51214	925 063-0	Size: 29x3 NBR
51548	925 091-1	Size: 49x3 NBR
50324	925 094-5	Size: 75x3 NBR
51290	925 257-8	Size: 89,5x3 NBR
70051	925 258-6	Size: 94,5x3 NBR
70056	949 658-9	Size: 24x3 FPM
51881	949 659-7	Size: 34x3 FPM
16032	955 984-0	Size: 10x1,5 NBR







Valve lifter

dph-no.	OEM-no.	application
36301	421 067-0	D50A, D50B, TD50A, TD50B, D60A, TD60A, TD60B, TD60C, TD61, TD63E, TD63ES, D70, TD70, TD71, TD73E, TD73ES, D6A, D7A, D7B
36302	479 031-7	D100, HD100, TD100, THD100, TD101*, THD101*, TD102*, THD102*, TD120, TD121*, TD122* *early production cast valve lifter, can not be used together with forged camshaft

Valve guide

dph-no.	OEM-no.	application
81918	1 545 135-4	Intake a. exhaust
61157	421 297-3	D70A, D70B, TD70A, TD70B, TD70C Turbo D70C
81843	466 386-0	Intake a. exhaust TD70D, TD70E, TD70F, TD70FC, TD70FS, TD70G, TD70H, TD70HA, TD71F, TD71FA, TD71FAQ, TD71FC, TD71FCQ, TD71FD, TD71FQ, TD71FS, TD71FSQ, TD71G TD FS- Turbo TD 71 Turbo
61156	422 320-2	Intake D100A, HD100A, TD100, THD100A, THD100E all, TD101from engine-196869, THD101, TD120, TD121, TD122, TD123 length: 82 mm
81918	1 545 135-4	Intake
61157	421 297-3	TD103, THD103, THD104, D10A, DH10A
81918	1 545 135-4	Exhaust
61157	421 297-3	D100A, HD100, TD100, THD100, TD101, THD101, TD102, THD102, TD103, THD103, THD104, TD120, TD121, TD122, TD123, D10A, DH10A

Valve seat ring

dph-no.	OEM-no.	application
61159	422 012-5	 <p>Exhaust D100A*, TD100A*, D100B*, HD100A, HD100D, THD100A*, THD100D* diam. 51, 101 – 51, 120 mm height: 9,4 – 9,5 mm</p> <p>*early production</p>
81984	467 475-0	 <p>Exhaust TD100, THD100A, THD100D late production THD100E, TD101, THD101 early production diam. 49, 054 – 49, 070 mm height: 11,4 – 11,5 mm</p>
61160	423 011-6	 <p>Intake TD120, TD121, TD122, TD123 diam. 59, 101 – 59, 120 mm height: 6,7 mm</p>
61158	422 011-7	 <p>Intake D100A/D100B/TD100A early production, HD100A, HD100D, THD100A*, THD100D* *early production diam. 54, 101 – 54, 120 mm height: 6,7 – 6,8 mm</p>
81917	1 545 886-2	 <p>Exhaust TD101, THD101 late production TD102, THD102, TD103, THD104</p> <p>diam. 49 mm height: 9,5 mm</p>
81616	421 012-6	 <p>Exhaust D70A, D70B, TD70A, TD70B, TD70C</p> <p>diam. 44, 074 – 44, 090 mm height: 9,4 – 9,5 mm</p>
61161	468 448-6	 <p>Exhaust TD120, TD121, TD122, TD123</p> <p>diam. 56, 579 – 56, 604 mm height: 9,4 mm</p>

Valve seat ring

dph-no.	OEM-no.	application
81617	421 011-8	Intake D70, TD70, TD71 diam. 46, 074 – 46, 090 mm



Valve

dph-no.	OEM-no.	application
61152	467 502	
81986	479 204	
61153	467 855	
61154	468 302	
61155	468 303	
109849	469 240-6	Size: 49 x 11 x 167,3 Intake THD 100 D Turbo
61152	467 502-1	Size: 50 x 11 x 167,2 Intake TD 103 ES-turbo TD100A, TD100B turbo TD100F, TD100G turbo THD100 E-turbo, TD 101F/G/GA THD101K-turbo, THD102KF turbo, TD103 E/ES turbo
81986	479 204	



Valve

dph-no.	OEM-no.		application
61153	467 855-3		Size: 46 x 11 x 167,2 Exhaust TD 103 ES turbo TD100A, TD100B turbo TD100F, TD100G turbo THD100 E-turbo, TD 101F/G/GA, THD101K-turbo THD102KF turbo, TD103 E/ES turbo
61154	468 302-5		Size: 54 x 11 x 167,2 Intake TD120 A turbo TD102 C/E/F, TD120 turbo TD121 F/G/GD, TD 121 turbo TD122 F/FS
61155	468 303-3		Size: 50 x 11 x 167,2 Exhaust TD120 A turbo TD102 C/E/F, TD120 turbo TD121 F/G/GD, TD 121 turbo TD122 F/FS
109844	1 547 492		Size: 40 x 8 x 192 Intake D12 A 4V turbo FH12 250-309 kW
109845	8 148 574		Size: 40 x 8 x 191,7 Exhaust TD120 A turbo TD102 C/E/F, TD120 turbo TD121 F/G/GD, TD 121 turbo TD122 F/FS
109846	1 556 472		Size: 47 x 9,5 x 176,8 Intake TD162 F-turbo TD163 ES, turbo F16 D16A 4V turbo FH 16
109847	1 543 027		Size: 45 x 9,5 x 176,9 Exhaust TD162 F-turbo TD163 ES, turbo F16 D16A 4V turbo FH16
109848	1 556 473		

● Plug cylinder head

dph-no.	OEM-no.	application
48317	467 365-3	D100, HD100, TD100, THD100, TD101, THD101, TD102, THD102, TD103, THD103, THD104, TD120, TD121, TD122, TD123 1 1/2"



● Plug cylinder head, cylinder block

dph-no.	OEM-no.	application
70023	467 367-9	For cylinder head: D50, TD50, D60, TD60, D70, TD70 For cylinder block: D50, TD50, D60, TD60-63, D70, TD70, 73, D100, HD100, TD100, THD100, TD101, THD101, TD102, THD102, TD103, THD103-04, D16A, TD120-23, TD162-163 1 3/4"



● Plug gasket

dph-no.	OEM-no.	application
49002	469 327-1	For plug 467 365-3, 1 1/2" For plug 467 367-9, 1 3/4"
49003	469 328-9	

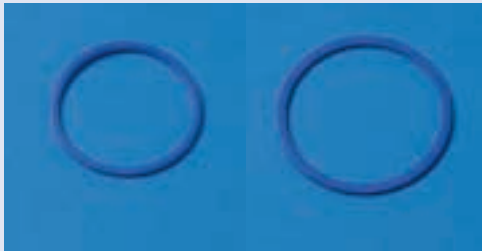

● Strainer oil pump

dph-no.	OEM-no.	application
48688	414 621-3	D50A, B, TD50A, B, D60A, TD60 early production D70A, D70B, TD70A, TD70E, TD70H, TD70HA, D100A, D100B, TD100A, TD100B, TD100BG, TD100C, HD100A, HD100D, THD100D, THD100DA, THD100DB, THD100DC, THD100DD, TD120



● Injector sleeve





dph-no.	OEM-no.	application
36196	465 547-8	D50A, D50B, TD50A, TD50B, D60A, TD60A
36197	466 284-7	D70A, D70B, TD70A, TD70E, TD70C, TD70D



● Injector sleeve

dph-no.	OEM-no.	application
36248	467 417-2	D100A, D100B, TD100A, TD100B, TD100BG, TD100C, HD100A, HD100D, THD100A, THD100D, THD100DA, THD100DD
36249	468 263-9	TD120A, TD120C, TD120E, TD120D
50325	479 163-8	
69199	468 784-4	
51289	470 247-8	
50351	466 403-3	
4295	466 404-1	



Injector sleeve kit

dph-no.	OEM-no.	application
36250	270 575-4	 TD60B, TD60C, TD61F, TD61FB, TD61FBQ, TD61FHQ, TD61G, TD61GA, TD61GC, TD61GE, TD61GS, TD63E, TD63ES
81842	276 130-2	 TD70F, TD70FC, TD70FS, TD70G, TD70H, TD70HA, TD71F, TD71FA, TD71FAQ, TD71FC, TD71FCQ, TD71FD, TD71FQ, TD71FS, TD71FSQ, TD71G, TD73E, TD73ES, D7A, D7B
36252	270 946-7	 TD100G, TD100GA, THD100E, TD101, THD101, TD102, THD102, TD103, THD103, THD104, D10A, DH10A
36253	273 822-7	 TD120F, TD120FA, TD120FC, TD120G, TD120GA up to engine -63804
36254	273 983-7	 TD120F, TD120FA, TD120FC, TD120G, TD120GA from engine 63805-, TD121, TD122, TD123

Injector seal

dph-no.	OEM-no.	application
37597	468 210-0	 TD120A, TD120C, TD120D, TD120E
35811	469 205-9	 D50A, D50B, TD50A, TD50B, D60A, TD60A, D70A, D70B, TD70A, TD70B, TD70C, TD70D, TD70E, D100A, D100B, TD100A, TD100B, TD100BG, TD100C, HD100A, HD100D, THD100D, THD100DA, THD100DB, THD100DC, THD100DD, TD120A, TD120C, TD120D, TD120E

Injector seal

dph-no.	OEM-no.	application
36294	469 455-0	 TD60B, TD60C, TD61, TD63, TD70F, TD70FC, TD70FS, TD70G, TD71, TD73, TD100G, TD100GA, TD101, THD101, TD102, THD102, TD103, THD103, THD104, TD120F, TD120FA, TD120FB, TD120FC, TD120G, TD120GA, TD121, TD12, TD123, D6A, D7A, D7B, D10A, DH10A
37549	466 405-8	 TD60B, TD60C, TD61, TD63, TD70F, TD70FC, TD70FS, TD70G, TD71, TD73, TH100G, TD100GA, TD101, THD101, TD102, THD102, TD103, THD103, THD104, TD120F, TD120FA, TD120FB, TD120FC, TD120G, TD120GA, TD121, TD122, TD123, D6A, D7A, D7B, D10A, DH10A

Thermostat

dph-no.	OEM-no.	application
81010	8 149 182-1	 82°C TD 61, TD63 TD70F, TD70FC, TD70FS, TD71, TD73, TD101, TD102, TD103, THD101, THD102, THD103, THD104, TD 121, TD122, TD123 D6A, D7A, D7B, D10A, DH10A
81011	1 676 306	

Oil seal injection pump driving unit

dph-no.	OEM-no.	application
37061	424 580-9	 D70*, TD70* *not for F86, FB86, F87, N86, NB86 with injection pump of rotary type, TD71, D100, TD100, HD100, THD100, TD101, THD101, TD102, THD102, TD103, TD120, TD121 TD122 excl.TD122FS with electronic diesel control Size: 29x50x10/7 ACM AW/BS LD







Oil pump repair kit

dph-no.	OEM-no.	application
36303	276 155-9	 TD60A from engine 23298-, TD60B, C, D70A, B, TD70A-E, H, HA, D100A, B, TD100A, B, BG, C, G, GA, TD101F, FA, FC, FD, G, GA, GB Not for trucks with MR61 or MR62B gearbox
36305	275 731	 F12, N12 (CH 306000 -), B12

Oil pump repair kit

dph-no.	OEM-no.	application
82952	276 156	F12 (- CH 34000), F12 (- CH 12000), F89 - G89
		

Repair kit (engine)

dph-no.	OEM-no.	application
97864	151 835-6	Bendix 15,5
		
82820	1 080 437	Bendix 15,5
		
82821	1 190 395	
		
82822	1 508 996	
		
82823	1 518 358	
		
82824	1 518 359	
		



● Repair kit (engine)

dph-no.	OEM-no.	application
82825	1 518 360	Bendix 15,5
82826	1 590 264	Bendix 15,5 2W440D
82827	1 594 266	Tuflo 600/700
82828	1 599 919	
82830	1 612 335	Bendix 15,5
82829	1 611 815	Tuflo 600/700
82930	1 620 462	







Repair kit (engine)

dph-no.	OEM-no.	application
82831	1 696 123	Piston ring kit
94387	1 696 124	Piston ring kit
94068	244 830-6	
94946	270 488	
94531	270 549	
81381	270 909	
81932	271 252	Bendix 02/05

● Repair kit (engine)

dph-no.	OEM-no.	application
84670	271 526-6	
81383	1 697 318	
81934	272 574	
81935	272 575	
81936	272 576	Bendix RG-1DC relay valve
81938	272 623	Bendix
81939	272 624	Bendix
81940	272 625	

Repair kit (engine)

dph-no.	OEM-no.	application
81941	272 626	
82812	272 631	Bendix 
94400	272 632	
81943	272 660	
81385	272 709	
81947	272 726	
81389	272 730	







● Repair kit (engine)

dph-no.	OEM-no.	application
81386	272 801	
81948	272 808	
81391	272 864	Bendix 02/05
70387	272 866	Wabco service kit
81408	272 878	Bendix Tuflo 501
70388	272 884	Wabco Service kit
81951	272 896	Repair kit ring kit Bendix

Repair kit (engine)

dph-no.	OEM-no.	application
94629	273 375	Repair kit
94628	273 706	
95657	274 104	
94532	274 105	
95533	274 106	
36304	275 715-1	Oil pump
81410	276 543	Bendix Tuflo 500

● Repair kit (engine)

dph-no.	OEM-no.	application
81401	3 090 288	Wabco 03
		
96287	3 090 377	
		
96286	3 090 379	Reed valve kit
		
96290	3 090 388	Piston ring kit
		
96281	3 094 155	Bendix
		
96283	3 094 156	Bendix
		
94605	3 097 147	
		





Repair kit (engine)

dph-no.	OEM-no.	application
82813	328 752	

Steel ring injector sleeve

dph-no.	OEM-no.	application
36306	466 420-7	 TD60B, TD60C, TD61, TD63, TD70F, TD70FC, TD70FS, TD70G, TD71, TD73, TD100G, TD100GA, THD100E, TD101, THD101, TD102, THD102, TD103, THD103, THD104, TD120F, TD120FA, TD120FB, TD120FC, TD120G, TD120GA, TD121, TD122, TD123, D6A, D7A, D7B, D10A, DH10A

Cylinder liner adjusting shim

dph-no.	OEM-no.	application
36289 *	422 619-7	 D100, HD100, TD100, THD100, TD101, THD101, TD102, THD102, TD103, THD103, THD104, D10A, DH10A *0,20 mm, **0,30 mm, ***0,50 mm
36971 **	422 620-5	
36290 ***	422 621-3	
37555 *	466 878-6	 D70, TD70, TD71, TD73 *0,12 mm, **0,20 mm, ***0,30 mm, ****0,50 mm
36282 **	466 114-6	
36283 ***	466 183-1	
36284 ****	466 184-9	
36287 *	465 394-5	 D60, TD60, TD61, TD63 *0,20 mm, **0,30 mm, ***0,50 mm
37556 **	465 395-2	
36288 ***	465 396-0	
36285 *	468 271-2	 TD120, TD121, TD122, TD123 *0,20mm, **0,30mm, ***0,50 mm
36286 **	468 272-0	
36309 ***	468 273-8	

● O-ring injector sleeve

dph-no.	OEM-no.	application
36298	466 922-2	 <p>TD60B, TD60C, TD61, TD63, TD70F, TD70FC, TD70FS, TD70G, TD70H, TD70HA, TD71, TD73, TD120F*, TD120FA*, TD120FB*, TD120FC*, TD120G*, TD120GA*, D6A, D7A, D7B *up to engine no. -63804</p>

Washers

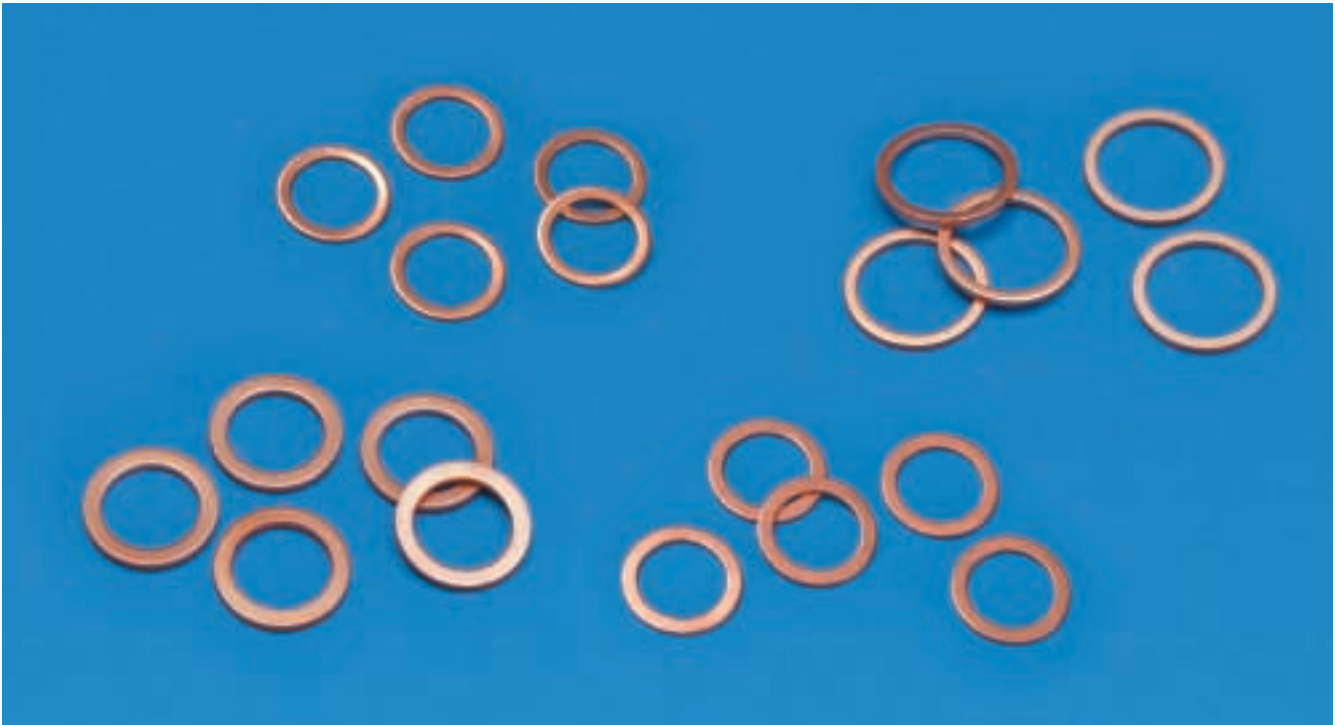

dph-no.	OEM-no.	application
95337	240 017-4	Size: 24x29x2 CU
37854	418 360-4	Size: 12x16,7x4 NBR for oil filter
69636	418 411-5	Size: 15x19,8x4 NBR water pump
37862	418 412-3	Size: 20x25x4 NBR engine
83873	942 580-2	Size: 8x13x1,5 ALU
81990	947 620-1	Size: 8x12x1 CU
81991	947 622	Size: 16x20x1,5 CU
34792	957 187	Size: 24x29x2 ALU
97191	977 751	Size: 18x24x1,5 CU
51883	421 158-7	Size: 29X35X5 NBR
48408	423 281-5	Size: 27x32x3,7 NBR EPL 281
48407	469 477-4	Size: 24,8x29,6x3,05 FPM
61628	469 479-0	Size: 22,5x28,5x3 NBR
61627	469 481-6	Size: 44,4x50,5x3 NBR

Washers

dph-no.	OEM-no.	application
69836	469 482-4	Size: 22x28x3 FPM
69863	469 606-8	Size: 50x56x3,7 FPM
50948	469 846-0	Size: 17x23x3 FPM
69922	469 952-6	Size: 27x33,5x3 FPM
69818	470 383-1	Size: 25x33,5x5,1 NBR
84367	471 626-2	Size: 19x27,7x7,40 FPM
69913	471 856-5	Size: 14,5x20x3 FPM
94042	1 526 181	Size: 28x35x5,5 NBR Abstreifer

Gasket

dph-no.	OEM-no.	application
97861	151 837-2	Valve plate
94323	1 542 780-0	Rubber
82906	1 610 078-6	
94554	1 655 638	80x70x4,3 green NBR
95278	1 655 778	
95279	1 655 780-3	
95276	267 386-1	



Gasket

dph-no.	OEM-no.	application
93363	341 488-5	
69757	382 010-7	
95277	382 055	
37449	420 160	EPL 160
50587	420 618-1	Turbo loader
51369	420 641-3	EPL 641
50327	420 642-1	Epl 642

Gasket

dph-no.	OEM-no.	application
69905	422 779-9	EPL 779
51233	424 618-7	EPL 618
36276	465 551-7	
50507	470 939-0	Turbo loader
50508	470 993-7	EPL 993
4356	478 074-8	VC 074 Valve cap

Gasket

dph-no.	OEM-no.	application	
80909	1 526 525-9		
35655	468 582-1	 138x143x11 NBR liner gasket	
94555	1 526 439	Size: 60x80x2 NBR	
50617	1 542 781-8	Size: 61x66,4x6 MVQ	

Rubber cushions for engine, exhaust systems and gearbox

Rubber cushion front engine mount

dph-no.	OEM-no.	application
36307	1 623 745-5	 <p>F7, F10, F12, F16, N7, N10 up to chassis No-49000, N10 USA with engine TD100C N10 BR MK2 up to chassis No..-604497, N12 up to chassis No -12000, N12 BR MK2 up to chassis No..-604497</p> <p>Upper cushion</p>
36308	1 503 490-3	 <p>F7, F10, F12, F16, N7, N10 up to chassis No..-49000, N10 USA with engine TD100C N10 BR MK2 up to chassis No -604497, N12 up to chassis No.-12000, N12 BR MK2 up to chassis No. -604497</p> <p>Lower cushion</p>
48217	1 611 420-9	 <p>N10 from chassis No..49001-, N10 USA with engine TD101GB N10 BR MK2 from chassis No..604498-, NL10 Australia, NL10 BR, NL10S N12 from chassis No.12001-, N12 BR MK2 from chassis No.604498- NL12 Australia, NL12BR, NL12S</p>



Rubber cushion exhaust system

dph-no.	OEM-no.	application
46782	6 850 149-3	 <p>F82-84, F86, FB86, F87-88, FB88, F89, G89, F4, F6, F6S, F7, F10, F12, N84, N86, NB86, N88, NB88, N7, N10, N10BR MK2, NL10BR, N12, N12BR MK2, NL12BR, B54-55, B57, BB57, B58, B58BR, B59, B6, B7F, FA, B9M, B10B, B10L, B10M, B10MBR, B10R, B12, B12BR, C10M for radiator and fan mounting to: B58BR, B59, B7ch.30000-, B9M, B10B, B10MBR, B10R for alternator mounting to: B9M, B10M, B10MBR thread M12</p>

Rubber cushion rear engine mount



dph-no.	OEM-no.	application
81618	1 573 891-7	 <p>F10, F12 N12 chassis 31104-, N10BR MK2, NL10 Australia, NL10BR, NL10S, N12 chassis 5551-, N12BR MK2, NL12 Australia, NL12BR, NL12S</p>

Motor rubber cushion

dph-no.	OEM-no.		application
94607	1 586 316		Gearbox mounting
94606	1 605 093		

Clutch, gearbox

Gearbox gasket set

dph-no.	OEM-no.	application
36296	270 824-6	 <p>F6S, FL616-619, F7, FE7, FL7, N7</p> <p>for gearboxes: R52 u. R52B</p>
36295	270 823-8	 <p>F7, FL7, F10, FL10, F12, N7, N10, N10BR MK2, N12, N12BR MK2</p> <p>for gearboxes: R61, SR61, R62, MR62, MR62BSR62, R63</p>

Oil seal gearbox input shaft

dph-no.	OEM-no.	application
70270	267 316-8	 <p>F86, FB86, F87, F6S, FL616-619, F7, FE7, FL7, N7</p> <p>for gearboxes: R50-52, R52B</p> <p>also for power take-off to following types: F88, FB88, F89, G89, F7, FL7, F10, FL10, F12, N7, N10, N10BR MK2, N12, N12BR MK2</p> <p>Size: 60x80x8/9,5 FPM BS</p>
35804	267 268-1	 <p>F86, FB86, F87-88, FB88, F89, G89, FL616-619, F7, FE7, FL7, FS7, F10, FL10, F12, F16, N88, NB88, N7, N10, N10BR MK2, NL10 Australia, NL10BR, NL10S, N12, N12BR MK2, NL12 Australia, NI2 BR, NL12S</p> <p>for gearboxes: R60-61, SR61, MR62, MR62B, R62, SR62, R1000, R1400, SR1400, R1700, SR1700, SR2000 B9M, B10M with gearbox: G7-EGS</p> <p>Size: 64,9x90x10 FPM BS LA RD</p>
35805	267 269-9	 <p>F86, FB86, F87, F88*, FB88*, FB89*, G89*, F6S, FL616-619, F7, FE7, FL7, F10, F12, N88, NB88, N7, N10, N10BR MK2, N12, N12BR MK2</p> <p>for gearboxes: R50-52, R52B, R60, MR61, R61, MR62, MR62B, R62, SR62, R63</p> <p>*also for transfer gearbox input shaft</p> <p>Size: 80x100x10 FPM BS LA LD</p>

Oil seal

dph-no.	OEM-no.		application
95880	1 526 828-7		Size: 105x130x12/9,5 AB/BS LD ACM dph
108799	6 876 127-9		Size: 48x65x10 B NBR
95881	6 876 126-1		Size: 48x69x10 B RD FPM
94046	943 741-9		Size: 26,3x36,2x7,3 AS NBR blue dph
108800	947 705		Size: 15x21x5 BS NBR
70465	192 600-5		Size: 70x90x10 B NBR Gearbox

Clutch servo cylinder

dph-no.	OEM-no.		application
80538	1 655 639-1		F86, FB86, F87, F89, G89, F6S, FE6, FL608-615, FL616-619, F7, FE7, FL7, FS7, F10, F12*, N7, N10, N10BR MK2, NL10 Australia, NL10BR, NL10S, N12, N12BR MK2, NL12 Australia, NL12BR, NL12S, B57, BB57, B58, B58BR, B6, B7 ch.-29999, B7F, B7FA, B9+10M**, B10R, C10M *not for single disc clutch from ch.314000- **for gearboxes: S6-80/85/90 and G7-EGS ch.-25462

Clutch servo cylinder

dph-no.	OEM-no.	application
81155	1 668 501-8	 F12 (CH 314000 -), F16, B10 (CH 20001 -), B12, FH12, FH16
95521	1 655 435	

Repair kit clutch master cylinder

dph-no.	OEM-no.	application
48857	276 546-9	 N7 up to chassis No.:6567, Australia-530095, N10 up to chassis No.:21719, Australia -540191, N12 up to chassis No.:3232, Australia -550077, F88, FB88, G88, F89, G89, B57*, BB57 *RHD with gearbox K191 manuel 5-speed
4381	273 660-1	 FL7, F10, FL10, F12, N7 ch.6568-, Australia ch.530096- N10 ch.21720-, N10BR MK2, Australia ch.540192-, N12 ch.3233-, N12BR MK2, Australia ch.550078-, B57*, BB57*, B58, B58BR, B7FB7FA, B9M, B10M, B10MBR, B10R, C10M early version *excl. gearbox K191
46717	271 106-7	 FL7, FS7, F10, FL10, F12, F16, N7, N10, N10BR MK2, NL10Australia, NL10BR, NL10S, N12, N12BR MK2, NL12Australia, NL12BR, NL12S, B57, BB57, B58, B58BR, B9M, B10B, BLE, M, MBR, R, B12, B12BR late version for clutch master cylinder ref.No.: 1620462-0 u.1669488-7

Repair kit clutch servo

dph-no.	OEM-no.	application
4396	273 632-0	 F86, FB86, F87-88, FB88, G88, F89, G89, N88, NB88, N7, N10, N12 for servo cylinder type: Clayton
36050	271 194-3	 F86, FB86, F87, F89, G89, F6S, FE6, FL608-615, FL616-619, F7, FE7, FL7, FS7, F10, F12*, N7, N10, N10BR MK2, NL10Australia, NL10BR, NL10S, N12, N12BR MK2, NL12Australia, NL12BR, NL12S, B57, BB57, B58, B58BR, B6, B7*, B7F, B7FA, B9M*, B10M*, B10MBR, B10R, C10M for servo- cylinder type: Volvo-Kongsberg *not for servo- cylinder type Ref: 1655435-4 **u.1668501-8** ** late version

● Repair kit clutch servo

dph-no.	OEM-no.	application
81929	270 586-1	For DPH 81155
		

● Repair kit gearbox control cylinder

dph-no.	OEM-no.	application
36048	273 081-0	F86, FB86, F87-88, FB88, F89, G89, F6S, F7, N86, NB86, N88, NB88, N7, N10, N12 for gearbox: R50-52, R60-61, SR61
		
36049	276 146-8	F6S, FL616-69, F7, FL7, F10, FL10, F12, N7, N10, N10BR MK2, N12, N12BR MK2, for gearbox: R52B, MR62, MR62B, R62, SR62, R63
		

● Repair kit gearbox inhibitor valve

dph-no.	OEM-no.	application
36046	273 082-8	F86, FB86, F87-88, FB88, G88, F89, G89, F6S, F7, F10, F12, N86, NB86, N88, NB88, N7, N10, N10BR MK2, N12 for gearbox: R50-51, R52*, R52B*, R60, MR61, R61, MR62B*, R62*, SR62*, SR63* *from gearbox: R52-22773, R52B-3672, R62-27350, MR62B, SR62-44215 LHD/v-styrd, excl. 41172-41639 MR62B, SR62-51496 RHD/h-styrd, SR62F12-41171 LHD/v-styrd, incl. 41640-42215
		
61170	276 335-7	F6S, FL616-619, F7, FE7, FL7, F10, FL10, F12, N7, N10, N10BR MK2, N12, N12BR MK2 for gearbox: R52, R52B, MR62B, R62, SR62 from gearbox: R52 22774-, R52B 3673, R62 27351-, MR62B, SR62 44216-LHD/v-styrd incl. 41172-41639, MR62B, SR62 51497-RHD/h-styrd, SR62 F12 41172-, excl. 41640-42215
		
46783	276 108-8	FL616-619, FE7, FL7, FS7, F10 from chassis No 25001-, F12 from chassis No 34001-, N10 from chassis No 306000-, N10BR MK2, FL10, FL16, NL10 Australia, NL10BR, NL10S, N12 from chassis No 306000-, NL12 Australia, NL12S for gearbox: R1000, R1400, SR1400, R1700, SR1700, SR2000
		

● Repair kit split cylinder

dph-no.	OEM-no.	application
51553	273 665-0	 <p>F88, FB88, G88, F89, G89, F7, FL7, F10, FL10, F12, N7, N10, N10BR MK2, N12, N12BR MK2</p> <p>for gearbox: SR62, SR70, SR71</p>
46718	270 925-1	 <p>FL7, FS7, FL10, FH12, F10 chassis No 25001-, F12 chassis No 34001-, N10 chassis No 306000-, N10BR MK2, NL10Australia, NL10BR, S N12 chassis No 306000-, N12BR MK2, N12 Australia, NL12BR, NL12S</p> <p>for gearbox: SR1400, SR1700, SR1900, SR1700 Geartronic, SR1900 Geartronic</p>

● Repair kit range cylinder

dph-no.	OEM-no.	application
46719	270 926-9	 <p>FL616-619, FE7, FL7, FS7, F10, FL10, F12, FH12, N10, N10BR MK2, NL10Australia, NL10BR, NL10S, N12, N12BR MK2, NL12Australia, NL12BR, NL12S, B9M, B10B, B10M, B12 early production</p> <p>for gearbox: R1000 b.Getr.Nr.-11842, R1400-27186, SR1400-27286, R1700-9336, SR1700-63971, SR1700 Geartronic -64825, SR1900-457, G7EGS</p>

● Repair kit (for cover to split cylinder and range cylinder)

dph-no.	OEM-no.	application
98283	3 094 518-2	 <p>FL616-619, FE7, FL7, FS7, F10, FL10, F12, FH12, F16, FH16, N10, N10BR MK2, NL10 Australia, NL10S, N12, NL12 Australia, NL12S, B9M, B10M</p> <p>for gearbox: R1000, R1400, SR1400, R1700, SR1700, SR1900, SR2000, SRO2400</p> <p>also for split cylinder relay valve (MECMAN): F7, FL7, F10, FL10, F12, F16, N7, N10, NL10BR, N10BR MK2, N12, N12BR MK2, NL12Australia</p>

● O-Ring cover range cylinder

dph-no.	OEM-no.	application
50323	967 344-3	 <p>FL616-619, FE7, FL7, FS7, F10, FL10, F12, FH12, N10, N10BR MK2, NL10Australia, NL10BR, NL10S, N12, NL12 Australia, NL12S, B7, B10B, B9M, B10M, B12, B12BR,</p> <p>for gearbox: R1000, R1400, SR1400, R1700, SR1700, SR1900, G7EGS, G8MGS</p>

● Support bearing kit propeller shaft

dph-no.	OEM-no.	application
36311	1 696 389-4	 <p>F6, F6S, FE6, FL608-615, FL616-619, F7, FE7, FL7, F10, FL10, F12, N7, N10, NL10BR MK2, NL10Australia, NL10BR, NL10S, N12, N12BR MK2, NL12BR, B57, BB57, B58BR, B7, B7F, B7FA, B9M, B10M, B10MBR</p> <p>Bearing inner diam. 60 mm</p>

Support bearing kit propeller shaft

dph-no.	OEM-no.	application
36312	263 567-0	FL7, F10, FL10, F12, FH12, F16, FH16, N10, NL10Australia, NL10S, N12, N12BR MK2, NL12Australia, NL12S Bearing inner diam. 70 mm



Repair kit air dryer

dph-no.	OEM-no.	application
37287	272 760-0	F6S, F7, FL7, FL10, F16 F10 fr.chassis No.25001-, F12 fr.chassis No.34001-, N7 fr.chassis No.12001-, N10 fr.chassis No.49001-, NL10Australia, NL10S, N12 fr.chassis No 12001-, NL12Australia NL12S, B58, B58BR, B6 splc S-6915 B9M, B10M: up to chassis No. -20000 B10MBR, B10R for BENDIX air dryers
36313	270 694-3	FL7, F10 fr.chassis No.25001-, F12 fr.chassis No.34001-, F16 B9M/B10M chassis No.20001-39999 2 kits required for WABCO air dryers



Gasket for oil filter

dph-no.	OEM-no.	application
69816	382 361-4	For oil filter 382353-1 (not in our range)



Seal ring

dph-no.	OEM-no.	application
95883	1 526 817-0	25x49,7x10,50/15 SP FPM rubber metal
50509	925 068-9	42x3 NBR OR 068



● Seal ring

dph-no.	OEM-no.		application
70234	949 722-3		36,2x3 FPM green OR 722
70054	1 526 474-0		17,3x2,4 NBR OR 6474

Brake parts

Repair kit air dryer drain valve

dph-no.	OEM-no.	application
81394	272 721-2	 <p>F6S, F7, FL7, FL10, F16, F10 fr.chassis No.25001-, F12 fr.chassis No.34001-, N7 fr.chassis No.12001-, N10 fr.chassis No.49001-, NL10Australia, NL10S, N12 fr.chassis No.12001-, NL12Australia, NL12S, B58, B58BR, B6-spcl S-6915, B9M/B10M up to chassis No...20000, B10MBR, B10R for BENDIX air dryers</p>

Diaphragm brake cylinder

dph-no.	OEM-no.	application
46784	1 614 797-7	 <p>F86, FB86, F87-88, FB88, G88, F89, G89, FL4, FL608-615, F7, FL7, F10, FL10, F12, F16, N84, N86, NB86, N88, NB88, N7, N10, N10BR MK2, NL10S, N12, NL12S, B59, B12, B12BR diaphragm type 20</p>
46785	1 614 798-5	 <p>F86, FB86, F87-88, FB88, G88, F89, G89, F7, FL7, F10, FL10, F12, F16, N86, NB86, N88, NB88, N7, N10, N10BR MK2, NL10Australia, NL10BR, NL10S, N12, N12BR MK2, NL12Australia, NL12BR, NL12S, B57, BB57, B58, B58BR, B59, B7, B7F, B7FA, B9M, B10M, MBR, 10R, C10M diaphragm type 24</p>
46786	1 614 799-3	 <p>F6USA, FE6, F7, FE7, FL7, F10, FL10, F12, FH12, F16, FH16, N7, N10, N10BR MK2, NL10Australia, NL10BR, NL10S, N12, N12BR MK2, NL12Australia, NL12BR, NL12S, B57, BB57, B58, B58BR, B59, B7, B7F, B7FA, B10B, B10L, B9M, B10M, B10MBR, B10R, B12, C10M diaphragm type 30</p>
69212	353 314	T9 - Ø 128
69214	325 197	T12 - Ø 139

Diaphragm brake cylinder

dph-no.	OEM-no.	application
69216	1 614 796	T16 - Ø 156
69222	1 518 741	T36 - Ø 224

O-Ring anchor pin

dph-no.	OEM-no.	application
70230	941 705-6	F85-86, FB86, F87-88, G88, F89, G89, F7, F10, F12, N84, N86, NB86, N88, NB88, N7, N10, N12, B57, BB57, B58, B58BR, B59, B9M, B10M, B10R dimension: 29,5x2,3 mm
61105	969 219-5	B57, BB57, B58, B58BR, B59, B7 ch.30000-, B7F, B7FA, B9M, B10B, B10M, B10R, C10M dimension: 24,7x1,7 mm
48076	969 220-3	F7, F10, F12, N7, N10, N10BR MK2, NL10BR, N12, N12BR MK2, NL12BR, B57, BB57, B58, B58BR, B7 ch.30000-, B7F, B7FA, B9M, B10B, B10M, B10MBR, B10R, C10M dimension: 29,75x3,53 mm

Tension spring brake shoe S-cam

dph-no.	OEM-no.	application
46733	346 499-7	F85, F7, F10, F12, N84, N7, N10, N10BR MK2, NL10BR, N12, N12BR MK2, NL12BR, B58BR, B7 ch.30000-, B7F, B7FA, B9M, B10MBR, B10R, C10M

Return spring Z-cam

dph-no.	OEM-no.	application
46793	3 097 092-5	FL7, F10, FL10, F12, FH12, F16, FH16, N10, NL10Australia, NL10S, N12, NL12Australia, NL12S, B7 ch.20000-29999, B10B, B10BLE, B10L, B12, B12BR



Dust cover Z-cam

dph-no.	OEM-no.	application
81522	3 090 954-3	FL7, F10, FL10, F12, FH12, F16, FH16, N10, NL10Australia, NL10S, N12, NL12Australia, NL12S, B7 ch.20000-29999, B10B, B10BLE, B10L, B12, B12BR



Thrust pin Z-cam

dph-no.	OEM-no.	application
81006	1 696 446-2	FL7, F10, FL10, F12, FH12, F16, FH16, N10, NL10Australia, NL10S, N12, NL12Australia, NL12S, B7 ch.20000-29999, B10B, B10BLE, B10L, B12, B12BR



Repair kit reverse lock Z-cam

dph-no.	OEM-no.	application
81004	276 097-3	FL7, F10, FL10, F12, FH12, F16, FH16, N10, NL10Australia, NL10S, N12, NL12Australia, NL12S, B7 ch.20000-29999, B10B, B10BLE, B10L, B12, B12BR left FL616-619 for trailing wheel brake 6x2 special S-60657, S-60917
81005	276 098-1	FL7, F10, FL10, F12, FH12, F16, FH16, N10, NL10Australia, NL10S, N12, NL12Australia, NL12S, B7 ch.20000-29999, B10B, B10BLE, B10L, B12, B12BR right FL616-619 for trailing wheel brake 6x2 special S-60657, S-60917



Repair kit brake adjusting Z-cam

dph-no.	OEM-no.	application
81001	3 097 099-0	 <p>FL10, F12, FH12, F16, FH16, N10, NL10Australia, NL10S, N12, NL12Australia, NL12S, B7 ch.20000-29999, B10B, B10BLE, B10L, B12, B12BR left-hand thread FL616-619 for trailing wheel brake 6x2 special S-60657, S-60917</p>
81987	8 550 977-6	 <p>FL7, F10, FL10, F12, FH12, F16, FH16, N10, NL10Australia, NL10S, N12, NL12Australia, NL12S, B7 ch.20000-29999, B10B, B10BLE, B10L, B12, B12BR right-hand thread FL616-619 for trailing wheel brake 6x2 special S-60657, S-60917</p>

Sealing kit Z-cam

dph-no.	OEM-no.	application
81953	272 905-1	 <p>FL7, F10, FL10, F12, FH12, F16, FH16, N10, NL10Australia, NL10S, N12, NL12Australia, NL12S, B7 ch.20000-29999, B10B, B10BLE, B10L, B12, B12BR FL616-619 for trailing wheel brake 6x2 special S-60657, S-60917</p>

Repair kit adjusting pin Z-cam

dph-no.	OEM-no.	application
81003	276 096-5	 <p>FL7 ch.SW-340707, AUS-561047, SC-890849 F10 ch.SW-340597, BEL-450239, SC-890823 FL10 ch.SW-340719, AUS-561047, SC-890865 F12 ch.SW-340594, BEL-450239, SC-890823 AUS-593365 F16 ch.SW-340585, AUS-503172 N10 ch.-341356, N12 ch.-341407, B7 ch.20000-20436 Trucks build in: SW= sweden AUS=australia, Bel=belgium, SC=scotland</p>
94692	3 090 964-2	 <p>FL7 ch.SW340708-, AUS561048-, SC890850- F10 ch.SW340598-, BEL450240-, SC890824- FL10 ch.SW340720-, AUS561048-, SC890866- F12 ch.SW340595-, BEL450240-, SC890824- AUS593366- F16 ch.SW340586-, AUS503173-, FH12, FH16, N10 ch.341357-, NL10AUS, NL10S, N12 ch.341408-, NL12AUS, S, B7 ch.20437-29999, B10B, BLE, L, B12 FL616-619 for trailing wheel brake 6x2 special S-60657, S-60917</p>

Cross shaft Z-cam

dph-no.	OEM-no.	application
81002	272 910-1	 <p>FL7, F10, FL10, F12, FH12, F16, FH16, N10, NL10Australia, NL10S, N12, NL12Australia, NL12S, B7 ch.20000-29999, B10B, B10BLE, B10L, B12, B12BR</p>

O-ring compressor connection

dph-no.	OEM-no.	application
61103	975 610-7	 <p>F84-86, FB86, F87-88, FB88, G88, F89, G89, F6, F6S, FE6, FL608-615, FL616-619, F7, FE7, FL7, F10, FL10, F12, F16, N7, N10, N10BR MK2, NL10Australia, NL10BR, NL10S, N12, N12BR MK2, NL12Australia, NL12BR, NL12S, B54, B57, BB57, B58, B58BR, B59, B6-7, B7F, B7FA, B9M, B10B, B10L, B10M, B10MBR, B10R, B12, C10M not for WABCO 704 FL616-619 for trailing wheel brake 6x2 special S-60657, S-60917</p>

Repair kit air brake compressor

dph-no.	OEM-no.	application
81409	272 813-7	 <p>F6, F6S, F7, FL7, F10, FL10, F12, N7, N10, N12, B7F, B7FA, BB57, B6 chassis -4999, for compressor 500 F86, FB86, F87, F88, FB88, G88, F89, G89, N86, NB86, N88, NB88</p>
81407	3 090 471-8	 <p>FL7, F10, FL10, F12, F16, NL10Australia, NL10BR, NL10S, NL12 Australia, NL12BR, NL12S, B58, B58BR, B59, B9M, B10M, B10MBR, B10R, C10M for compressor: 15, 5</p>
81392	6 645 225-1	 <p>F6, F6S, F7, FL7, F10, FL10, F12, N7, N10, FL12, F16 NL10Australia, NL10S, N12, NL12 Australia, NL12S, B58BR, B6, B7F, B7FA, B9M, B10B, L, M, R, B12BR, C10M F86, FB86, F87, F88, FB88, G88, F89, G89, N86, NB86, N88, NB88 B12 chassis -4999</p>

Repair kit

dph-no.	OEM-no.	application
81007	1 696 450-4	
81383	1 697 318	 <p>Repair kit air brake</p>

Repair kit

dph-no.	OEM-no.	application
81382	270 910	Repair kit air brake Wabco 4757010010/10200
81387	270 969	Foot brake valve kit Wabco 4613150080/0090/0170
82814	272 571	Foot brake valve kit, Wabco
81390	270 890	Repair kit brake valve kit
81937	272 577	Hand control valve kit, Wabco
81384	272 712	Repair kit trailer control valve, Wabco
81388	272 731	Repair kit quick release valve Bendix 274996

Repair kit

dph-no.	OEM-no.	application
81411	272 790	Repair kit hand control valve
81412	272 794	Repair kit hand control valve Wabco 9617222520
81949	272 860	Repair kit trailer control valve
81413	272 875	Wabco hand control valve
81406	270 698-4	

King pin kit

dph-no.	OEM-no.	application
46794	3 090 267-0	F86, FB86, F87, F88, FB88, F89, G89, N86, NB86, N7, N10, N12, B57, BB57, B58, B59 late production F6S, FE6, FL616-617, F7, FE7, FL7, FS7, F10, FL10, F12, F16, N10BR MK2, NL10Australia, NL10BR, N12BR MK2, NL12Australia, NL12BR, B58BR, B6, B7 ch.20000-, B7F, B7FA, B9M, B10M, B10MBR, B10R king pin upper: diam. 48 mm
46795	3 090 266-2	FL618-19, F7, FE7, FL7, FS7, F10, FL10, F12, F16, FH16, N7, N10, N10BR MK2, NL10BR, NL10S, N12, N12BR MK2, NL12 BR, NL12S, B9M ch.20001-, B10B, B10L, B10M ch.20001-, C10, B12, B12BR Olympian MK2 king pin upper: diam. 50 mm

Expansion pin for anchor pin

dph-no.	OEM-no.	application
46791	951 982-8	For anchor pin 1 584 671-0
46792	951 983-6	For anchor pin 1 584 673-6, 1 586 716-1



Pinion Z-cam

dph-no.	OEM-no.	application
81008	1 696 924-8	FL616-619*, FL7, F10, FL10, F12, FH12, FL12, F16, FH16, N10, NL10 Australia, NL10S, N12, NL12 Australia, NL12S, B7 ch. 20000-29999, B10B, B10BLE, B10L, B12, B12BR *for trailing wheel brake 6x2 special S-60657, S-60917 left
81009	1 696 925-5	FL616-619*, FL7, F10, FL10, F12, FH12, FL12, F16, FH16, N10, NL10 Australia, NL10S, N12, NL12 Australia, NL12S, B7 ch. 20000-29999, B10B, B10BLE, B10L, B12, B12BR *for trailing wheel brake 6x2 special S-60657, S-60917 right



Front and rear axel parts

Oil seal

dph-no.	OEM-no.		application
80493	1 522 373-8		Rear axle Size: 50x65x80 B WD FPM dph
69293	1 522 894-3		Rear axle Size: 80x150x12/20 SP RD LA FPM dph
80047	338 425		Size: 25x35x8 NBR AD Steering
69289	943 250-1		63,5x110x12 BS LD FPM dph rear axle
80881	944 665-9		148x168/170x32 B WD NBR dph rear axle
94316	944 671-7		126x173x15 C Spezial NBR front and rear

Oil seal

dph-no.	OEM-no.	application
80013	946 026-2	Size: 152,4x120,65x13/12 NBR dph front and rear
108798	947 270-5	Size: 85x110x13 A NBR front axle
69291	948 642-8	Size: 90x125,25x10 BS RD LA FPM dph rear axle

Oil seal steering gear

dph-no.	OEM-no.	application
36627	341 050-3	F84-85, F88, FB88, G88, F89, G89, F6, FE6, FL608-615, FL616-19, F7, FE7, FL7, F10, FL10, FS10, F12, F16, N84, N86, NB86, N88, NB88, N7, N10, N10BR MK2, NL10Australia, NL10BR, NL10S, N12, N12BR MK2, NL12Australia, NL12BR, NL12S, B57, BB57, B58, B58BR, B59, B6 ch.5000-, B7, B7F, B7FA, B9M, B10B, B10M, B10MBR, B10R, B12, B12BR for ZF-steering gear

Oil seal pinion differential carrier

dph-no.	OEM-no.	application
36626	1 522 895-0	F86, FB86, F87-88, FB88, F89, G89, F6S, FE6, FL616-619, F7, FE7, FL7, F10, FL10, F12, FH12, F16, FH16, N86, NB86, N88, NB88, N7, N10, N10BR MK2, NL10Australia, NL10BR, N12, N12BR MK2, NL12Australia, NL12BR MK2, B57, BB57, B58, B58BR, B59, B7, B7F, FA, B9M, B10B, M, MBR, R, C10M for rear axle types: DR80, EV71, EV80, 80B, EV8181B+C, EV82, 82B also for transfer gearbox: F88, FB88, G88, F89, G89, F10, F12, N10, NL10S, N12

Oil seal companion flange differential carrier

dph-no.	OEM-no.	application
59232	948 448-6	F86GB, F7, FL7, F10, FL10, F12FH12, F16, FH16, N10, N10BR MK2, NL10Australia, NL10BR, NL10S, N12, N12BR MK2, NL12Australia, NL12BR, NL12S for tandem rear axle for rear axle types: CT EV, RT EV, RT N

Oil seal front wheel hub

dph-no.	OEM-no.	application
70269	191 160-1	F86, FB86, F87, N86, NB86, N88, NB88 early production, front axle pressure 5 t also for rear axle hub to F83S
36375	944 667-5	F86, FB86, F88, FB88, G88, F89G89, F6S ch.3146-6499, F7*ch.-27087, F10*ch.-26821, F12*ch.-36736 N7*ch.-12099, N10*ch.-52439, N10BR MK2*, N12BR MK2*, N12*ch.-15169, B57, BB57, B58, B58BR B7F, B7FA ch.-10521, B9M**, B10M**, B10MBR**, B10R ch.-3906 *with front axle pressure 6,5 t ** with grease lubricated hubs

Oil seal front wheel hub, trailing wheel hub

dph-no.	OEM-no.	application
46716	1 089 552-2	
46810	1 587 792-1	
		FE615, FL616-619, FE7, FL7, FS7, FL10, FS10, FH12, F16, FH16, NL10S excl.6x4, NL12S excl.6x4, F7 ch.27088*, F10 ch.26822*, F12 ch.36764, N7 ch.12001*, N10 ch.52440*, N12 ch.15170*, B6 ch.865-4999, B7F, B7FA ch.10522-, B10R ch.3907-, B7, B9M, B10B, B10L, B10M, B10MBR, C10M, B12 *with front axle pressure 6,5 tons and all with 7,5/8 tons For trailing wheel hub to: F7, FL7, F10, FL10, F12, F16, B9M, B10M, B12 Size: 110x140x12/21 NBR *S-ride, air suspension

Oil seal inner, rear wheel hub

dph-no.	OEM-no.	application
98342	1 610 765-8 FPM	
		F86, FB86, F87, F88/FB88/G88 ch.36634, F89, G89, F7, FL7, F10, FL10, F12, FH12, F16, FH16, N86/NB86 late production N7, N10, N10BR MK2, NL10Austral., NL10BR, NL10S, N12, N12BR MK2, NL12Austral., NL12BR, NL12S, B57, BB57 ch.3405-7980, B58BR, B7 ch.30000-, B7F, B7FA, B9M, B10B, B10BLE, B10L, B10BR, B10R, C10M, B12, B58AUS, Olympian MK2 Size: 168x188/192,5x30 FPM B WD SP

Sealing kit outer, rear wheel hub

dph-no.	OEM-no.	application
80969	3 090 331-4	
		F84-86, FB86, F87-88, FB88, G88, F89, G89, F6S ch.-6871, FL618-619 chid. B115391-, F7, FL7, FS7, F10, FL10, F12, FH12, F16, FH16, FL12, N84, N86, NB86, N88, NB88, N7, N10, N10BR MK2, NL10Austral., NL10BR, NL10S, N12, N12BR MK2, NL12Austral., NL12BR, NL12S, B54, B57, BB57, B58, B58BR, B59, B7 ch.30000-, B7F, B7FA, B9M, B12BR, B10B, B10BLE, B10L, B10M, B10MBR, B10R, C10M, B12B Olympian MK2

Oil seal, trailing wheel hub

dph-no.	OEM-no.	application
37598	1 610 765-8	
		F7 ch.19746-, F10 ch.20877-, FL10, F12 ch.22915-, FH12, F16, FH16, N10 ch.46316-, NL10S, N12 ch.8780-, NL12S Nitrile version – must only be used on trailing axles Size: 168x188/192,5x30 ACM WD

Oil seal kit rear axle hub reduction

dph-no.	OEM-no.	application
36587	273 394-7	 <p>F88, FB88, G88, F89, G89, N88, NB88, N10 ch.-56683, N10BR MK2, NL10BR, N12 ch.-18480, N12BR MK2, NL12BR, B58BR, B10MBR for rear axles: N1 80, N1 81, N2 81, N1 82, N2 82, N1 87, N2 87</p>

Oil seal rear axle hub reduction

dph-no.	OEM-no.	application
37599	1 522 372-0	 <p>FL7, F10, FL10, F12, FH12, F16, FH16, N10, N10BR MK2, NL10Australia, NL10BR, NL10S, N12, N12BR MK2, NL12Australia, NL12BR, NL12S, B9M, B10M Portugal spec. S-4621 for rear axles: N3 71, N3 72, N4 71 Size: 140x164x20/23,5 FPM SP</p>

Wear ring rear axle hub, trailing wheel hub

dph-no.	OEM-no.	application
61171	944 670-9	 <p>For real wheel hub: F6S up to chassis No.-6871 for trailing wheel hub: F7 ch.-19745, F10 ch.-20876, F12 ch.-22914, N7*ch.-12000, N10*ch.-17289, N12*ch.-8779 *with disc wheels</p>

Lock washer rear wheel hub, trailing wheel hub

dph-no.	OEM-no.	application
46729	191 179-1	 <p>F84-86, FB86, F87-88, FB88, G88, F89, G89, F6S, FE615, FL616-619, F7, FE7, FL7, FS7, F10, FL10, F12, FH12, F16, FH16, N84, N86, NB86, N88, NB88, N7, N10, N10BR MK2, NL10Austr., NL10BR, NL10S, N12, N12BR MK2, NL12Aust., NL12BR, NL12S, B54-55, B57, BB57, B58, B58BR, B59, B7, B7F, B7FA, B9M, C10M, B10B, B10BLE, B10L, B10M, B10R, B10R, B12, B12BR Olympian MK2</p>

Tab washer front wheel hub, steering knuckle

dph-no.	OEM-no.	application
46730	1 575 525-9	 <p>F86, FB86, F87-88, FB88, F89, G89, F6S ch.3146-early production, F7, FL10, F10 ch.-26821*, F12 ch.-36763*, N7 ch.-5847-12099*, N10 ch.-52439*, N10BR MK2, N12 ch.-15169*, B57, BB57, B58, B58BR, B59, B7F, B7FA, B9M/B10M ch.-11499** *front axle pressure 6,5 t/7 t **also for steered trailer axle up to chassis No.-20000 thickness: 2 mm</p>

O-ring rear axle hub

dph-no.	OEM-no.	application
80523	948 767-9	 FL7, F10, N10, FL10, F12, FH12, FL12, F16, FH16, N10, N10BR MK2, NL10 Australia, NL10BR, NL10S, N12, N12BR MK2, NL12 Australia, NL12BR, B10M special S-4621 Portugal for rear axles with hub reduction Size: 248x3 NBR 70

Gasket kit steering gear

dph-no.	OEM-no.	application
96162	271 524-1	 N7, N10, N12, F7, F10, F12 for steering gear: ZF no. 8045 955 109 Volvo 250182-3 ZF no. 8045 955 131 Volvo 250194-8 ZF no. 8045 955 141 Volvo 250202-9 ZF no. 8045 955 143 Volvo 250205-2
81933	271 561	
81955	276 140-1	
81490	270 171-2	 ZF steering UTV 20,2 F7, F10, F12, F16 Front axle load 6,5/6,7 tons LHD
81505	271 567-0	 N7 - CH 12000, N10 - CH 49000, N12 - CH 305999
70385	271 525-8	 ZF steering gear F7, F10 - CH 25000, F12 - CH 34000, N7 - CH 12000, N10 - CH 49000, N12 - CH 12000, B10

Gasket kit steering gear

dph-no.	OEM-no.	application
81498	271 560-5	ZF steering gear UTV 23,6 F7, F10, F12, F16 Front axle load 6,5/6,7 tons LHD



Wheel accessory kit

dph-no.	OEM-no.	application
82324	968 012-5	Rear FL4, FL608-611 Size: 100x120x12 NBR AS
94317	968 013-3	Front FL612-614 FAT 5.0 FAT 5.6 Size: 110x130x12 NBR AS





Seal ring

dph-no.	OEM-no.	application
81992	967 852-5	Size: 47,35x1,78 NBR 70 front/rear axle



O-ring for hub cap

dph-no.	OEM-no.	application
61565	925 261-0	For front and trailing wheel hub cap to: F86, FB86, F87, F88, FB88, G88, F89, G89, FE6, FL616-619, F7, FE7, FL7, FS7, F10, FL10, F12, FH12, FL12, F16, FH16, N86, NB86, N7, N10, N10BR MK2, NL10 Australia, NL10BR, NL10S, N12, N12BR MK2, NL12 Australia, NL12BR, NL12S, B57, BB57, B58, B58BR, B59, B6 ch.-4999, B7, F7F, B7FA, B9M, B10B, B10L, B10M, B10MBR, B10R, C10M, B12, B12BR also for brake valve to: F4, F6, F10 ch.- 40640, F12 ch.-65820, N7 ch.-12000, N10 ch.-49000, N12 ch.-12000, B58, B58BR ch.-304120, B59, B6 ch.-4999, B9M/B10M ch.-20000, B20R, C10M Size: 109,5x3 NBR 70



Bogie lift parts

● Plastic bearing bogie

dph-no.	OEM-no.	application
48454	1 581 543-4	F7, FL7, F10, FL10, F12, FH12, F16, FH16, N10, N10BR MK2, NL10Austr., NL10BR, NL10S, N12, N12BR MK2, NL12Austr., NL12BR, NL12S F88/G88 6x2 ch. LD41345-, RHD41580-



● Bolt bogie roller

dph-no.	OEM-no.	application
61172	363 908-5	FB86 late production, F88/G88 LHD/ch.41345- RHD/ ch.41580- F89/G89 late production, F7, FL7, F10, FL10, F12, F16, N7, N10, NL10S, N12, NL12S 6x2, 8x2



● Bushing balance arm bogie suspension

dph-no.	OEM-no.	application
48689	1 590 885-8	FB86 late production, F88/G88 LHD/ch.41345- RHD/ch.41580- F89/G89 late production, F7, FL7, F10, FL10, F12, FH12, F16, N7, N10, NL10S, N12, NL12S 6x2, 8x2



● Thrust washer balance arm bogie suspension

dph-no.	OEM-no.	application
48690	1 593 431-8	FB86 late production, F88/G88 LHD/ch.41345- RHD/ch.41580- F89/G89 late production, F7, FL7, F10, FL10, F12, FH12, F16, N7, N10, NL10S, N12, NL12S 6x2, 8x2

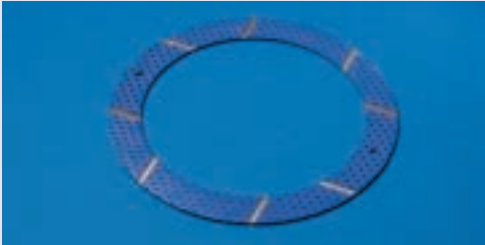

Oil seal balance arm bogie suspension

dph-no.	OEM-no.	application
51729	945 538-7	 FB86 late production, F88/G88 LHD/ch.41345- RHD/ch.41580- F89/G89 late production, F7, FL7, F10, FL10, F12, FH12, F16, N7, N10, NL10S, N12, NL12S 6x2, 8x2

Gasket kit bogie lift cylinder

dph-no.	OEM-no.	application
70222	273 404-4	 F86, FB86, F87, F88/FB88/G88 ch.30001-, F89, G89 early production for SOERLING bogie lift
51731	273 712-0	 F86, FB86, F87, F88/FB88/G88 ch.30001-, F89, G89 late production F7, FL7, F10, FL10, F12, F16, N7, N10, NL10S, N12, NL12S alternative 1 for cylinder ref.Nr.: 1505636-9
51732	276 110-4	 FL7*, F10 ch.314000-*, FL10*, F12 ch.314000-*, FL12, FH12, F16*, FH16, N10 ch.306000-*, NL10S*, N12 ch.306000-*, NL12S* *alternative 2 for cylinder ref.Nr.: 1698818-0, 1698819-8

Front and rear suspension parts

Shackle pins front spring

dph-no.	OEM-no.	application
48350	1 614 229-1	 <p>F88, FB88, G88, F89, G89, F7, FL7, F10, FL10, F12, FH12, F16, FH16, N88/NB88 bogie spring ch.23107-, N7, N10, N10BR MK2, NL10 AUS, NL10BR, NL10S, N12, N12BR MK2, NL12AUS, NL12BR, NL12S</p>
48351	1 614 230-9	 <p>F7, FL7, F10, FL10, F12, FH12, F16, FH16, N7, N10, N10BR MK2, NL10AUS, NL10BR, NL10S, N12, N12BR MK2, NL12AUS, NL12BR, NL12S</p>

Shackle pin rear spring

dph-no.	OEM-no.	application
61169	1 609 960-8	 <p>F86/FB86/F87 LHD ch.20654-, RHD ch.21109-, F88/FB88/G88 LHD ch.41345-, RHD ch.41580-, F89/G89 ch.6998-, F7, FL7, F10, FL10, F12, FH12, F16, FH16, N7, N10, NL12S, N10BR MK2, NL10S, N12 6x2, 8x2</p>

Shackle pin (bolt) rear spring

dph-no.	OEM-no.	application
46796	1 598 764-7	 <p>For front end of the spring to: F7, FL7, F10, FL10, F12, F16 4x2 semi</p> <p>For sliding block to: F7, F10 ch.-40640, F12 ch.-65820, 4x2, 6x2 with air suspension</p>

Shackle pin (bolt) rear spring, rear end

dph-no.	OEM-no.	application
46797	1 598 766-2	 <p>4x2 semi</p> <p>FL7*, FL10*, F10**, F12**, FL12*, F16**</p> <p>*with soft single parabolic springs **with parabolic springs</p>

Shackle bushing rear spring

dph-no.	OEM-no.	application
48349	1 608 019-4	<p>4x2 semi with parabolic springs to: FL7, F10 ch. 25001-, FL10, F12 ch. 34001-, FL12, F16</p> <p>4x2 semi with air suspension to: F10 ch. 25001-40640, F12 ch. 34001-65820 Inner bushing</p>



Shackle bushing spring

dph-no.	OEM-no.	application
51730	1 586 089-3	
46726	1 610 110-7	



Spring washer

dph-no.	OEM-no.	application
48352	941 916-9	For nut: 961997-4



Plastic bushing front anti-roll bar

dph-no.	OEM-no.	application
46798	1 611 551-1	FL616-619 ch.457577-, F7 ch.16718-, FL7, FS7, F10 ch.19713-, FL10, F12 ch.19782- F16, N7 ch.10904-, N10 ch.39080-, N10BR MK2 ch.604498-, NL10Australia, NL10BR, NL10S, N12 ch.8289-, N12BR MK2 ch.604498-, NL12Australia, NL12BR, NL12S
46799	1 589 807-5	FL616-619 ch.457577 with leaf springs, F7 ch.16718-, FL7 ch.384649-, 562050, 906412-, FS7, FL10 ch.-384649, F10 ch.19713-, F12 ch.19782-, F16, N7 ch.10904-, N10 ch.39080-, N10BR MK2 ch.604498-, NL10Australia, N12 ch.8289-, N12BR MK2 ch.604498-NL12Australia, NL12BR, NL12S, B7ch.20000- also for rear anti roll bar to FL608-611 air suspension B6 ch.5000- length 22,5 mm



Rubber bushing rear anti-roll bar

dph-no.	OEM-no.	application
48361	1 580 010-5	 <p>LOWER bushing F86/FB86/F87 ch.32700- track 1820, F89/G89 Switzerl., F7, FL7, F10, FL10, F12, F16, N7, N10, N10BR MK2, NL10Australia, NL10BR, NL10S, N12, N12BR MK2, N12Australia, NL12BR, NL12S 4x2, 4x4 K1D, K2D, P2D, P2DL, P2DR</p>
48319	1 580 009-7	 <p>UPPER bushing F86/FB86/F87 ch.32700- track 1820, F89/G89 Switzerl., F7, FL7, F10, FL10, F12, F16, N7, N10, N10BR MK2, NL10Australia, NL10BR, NL10S, N12, N12BR MK2, N12Australia, NL12BR, NL12S 4x2, 4x4 K1D, K2D, P2D, P2DL, P2DR</p>
46800	1 609 768-5	 <p>FL7, F10 fr. chassis No.39135-, FL10, F12 fr.chassis No.61305-, F16 FL12, FL16, NL10S, NL12S 4x2 P2, P2L</p>
46801	1 587 261-7	 <p>FL7, F10 fr.chassis No.25001-, FL10, F12 fr.chassis No.34001-, F16 FL12, NL10S, NL12S 4x2 P2, P2L length 26 mm</p>
51554	1 575 339-5	 <p>F86, FB86, F87, F7, FL7, F10, FL10, F12, FH12, F16, FH16, N7, N10, N10BR MK2, NL10S, N12, NL12S 6x2, 8x2, 6x4, 8x4 with leaf spring</p>
80967	1 605 182-3	 <p>UPPER bushing white FL7, F10 v. chassis No..25001-, FL10, F12 v.chassis No..34001-, FH12, F16, FH16 4x2, 6x2, 6x4, 8x4 with air suspension inner diam. 55 mm</p>
80966	1 605 047-8	 <p>LOWER bushing black FL7, F10 fr. chassis No.25001-, FL10, F12 fr.chassis No..34001-, FH12, F16, FH16 4x2, 6x2, 6x4, 8x4 with air suspension inner diam. 60 mm</p>

Rubber bushing rear anti-roll bar

dph-no.	OEM-no.	application
80968	1 607 561-6	<p>LOWER bushing yellow</p> <p>FL7, F10 fr.chassis No.25001-, FL10, F12 fr.chassis No.34001-, FH12, F16, FH16 4x2, 6x2, 6x4, 8x4 with air suspension inner diam. 65 mm</p>



Rubber bushing

dph-no.	OEM-no.	application
48077	1 134 962-8	<p>F84, F85, F86, FB86, F87, F88, FB88, G88, F88, G89, FL4, F6, FE6, F6S, F6,FE7, FL7,FS7, F10, FL10, F12, FL12, F16, N84, N86, N88, NB88, N7, N10, N10BR MK2, NL10 Australia, NL10BR, NL10S, N12, N12BR MK2, NL12 Australia, NL12BR, NL12S, B54, B57, BB57, B58BR, B6, B7, B7F, B7FA</p>
70031	3 028 447-5	
61078	3 028 448-3	
61079	3 028 449-1	
95142	1 598 588	









Sleeve anti-roll bar







dph-no.	OEM-no.	application
61582	1 625 954-1	 <p>For front anti roll bar to: FL608-615, FL616-619 ch.457577-, F7 ch.16718-, FL7, FS7, F10 ch.19713-, FL10, F12 ch.19782-, F16, N7ch.10904-, N10 ch.39080-, N10BR MK2 ch.604498-, NL10Australia, NL10BR, NL10S, N12 ch.8289-, N12BR MK2 ch.604498-NL12Australia, NL12BR, NL12S, B7 ch.20000-</p> <p>for rear antiroll bar to: FL608-615 ch.473176-with leaf springs F616-619 with leaf springs, FS7 with leaf springs, B6 ch.5000-</p>
61583	1 588 445-5	 <p>FL7, F10 ch.25001-, FL10, FL12 F12 ch.34001-, F16, NL10S, NL12S</p> <p>4x2 semi P2P2L</p>

Bushing V-stay

dph-no.	OEM-no.	application
93466	1 075 255-8	 <p>For air suspension</p> <p>For V-stay front suspension to: B10B, B10BLE, B9M/B10M ch.-20001-, B12</p> <p>for V-stay rear suspension to: F7, FL7, F10 ch.25001-, FL10, F12 ch.34001-, FH12, FL12, F16, FH16, NL10BR 6x2, NL12 BR 6x2 ch.635001-, B9M, B10M</p>

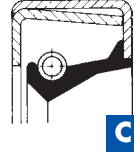
Overview of most popular oil seal types acc to DIN 3760/3761

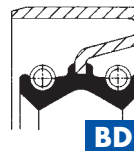
Application	Description
 A	rubber version with single lip
 AS	rubber version with sealing and dust lip
 AD	rubber version with 2 lips and 2 springs
 AW	rubber version with sealing lip and corrugated profile
 ASW	rubber version with sealing lip and dust lip and corrugated profile
 A/B	seal with combined elastomer/ metal outer cover

Application	Description
 B	metal cased open
 BS	metal cased open with dust lip
 C	metal cased closed
 CS	metal cased closed with dust lip
 BD	metal cased open with 2 lips
 A/BS	seal with combined elastomer/ metal outer cover with dust lip

Abbreviations at „style“

FL Washer
PR Profile seal
OR O-Ring
WR Oil seal

Complimentary definitions

RD Right hand helix
LD Left hand helix
WD Double helix
SF Special design
OF Without spring
V Reinforced seal lip
LA With sealant film
W Corrugated profile
SP Special

Abbreviations at „mat“ (material)

ACM Polyacryl rubber
FPM Fluor rubber (Viton)
MVQ Silicone rubber
NBR Nitril rubber
EPDM Ethylen-Propylen-Dien-rubber
PTFE Polyterafluorethylen
HNBR Hydrogenated NBR
AL Aluminium
CU Copper
FE Iron
FZ Felt

Oil seals





Company

Since our establishment in 1986 we have concentrated entirely on quality products which provide our discerning customers with the high value and quality that they have come to expect.

Our company headquarters including the production plant and main warehouse is located in the lovely rural suburbs of Hamburg. Here, on an area covering more than 7,500 m², we have the hub of our operations, from which we distribute worldwide. We also have multiple branches in South Africa and Turkey, as well as in China and Dubai. In addition, our close-knit network of representatives and distributors ensures that we are close to our customers all over the world.

We see quality, flexibility and reliability as being inseparably linked. Our large product range is growing constantly and is subject to comprehensive quality management and orientated to the specific needs of the individual markets into which we supply.

Our slogan is "Seal it with a smile".

Because what counts most for us is that you are satisfied with our products and services.

Manufacturing

Only state-of-the-art manufacturing allows the production of rubber and special seals corresponding to the unique requirements of the world's markets and ensures their sales and distribution.

When we talk about being market driven, we mean

- **top quality**
- **short delivery times**
- **fair pricing**

Our production facility is outfitted with the latest technical equipment and upgraded continually. The experience and expertise of our production staff are further features of our high manufacturing quality.

The know-how of our design engineers guarantees short production times for the necessary tools and makes us independent of upstream suppliers. We maintain a comprehensive raw materials warehouse and have a production area which is ideal for the size of our business. Our wide range of machinery enables us to perform the tasks placed before us in terms of size and feeding.

Besides having our own tool shop, our extensive stock of standard dimensions ensures short delivery times. Our product range encompasses well over 150,000 articles. More than 20,000 different products are continuously available from stock.



Table of contents

OEM	017
ALFA	018
BMW	018 – 021
BPW / CATERPIL / CITROEN	021 – 022
CUMMINS / DAF	022 – 024
DB	024 – 053
DEUTZ / EVOBUS / FERRARI / FIAT / FORD	053 – 058
FRUEHAUF / FULLER / HENDRICKSON / IVECO	058 – 062
KB / KHD / KIA / LADA / LANCIA	062 – 063
MAN	063 – 071
MAZDA / MF / MITSUBISHI / MWM	071
NEW HOLLAND / NISSAN	071
OPEL	071 – 074
PERKINS / PEUGEOT / PORSCHE	074 – 076
RENAULT / ROR / ROVER / RVI	076 – 079
SAAB / SAF / SCANIA	079 – 083
STEYR / SUBARU / SUZUKI / TOYOTA	083
TRAILOR / VOLVO / VOLVO PC	084 – 088
VW / ZF	088 – 094
Dimensions	095 – 174
Elring-No.	175 – 206
Corteco-No.	207 – 250

Radial oil seals

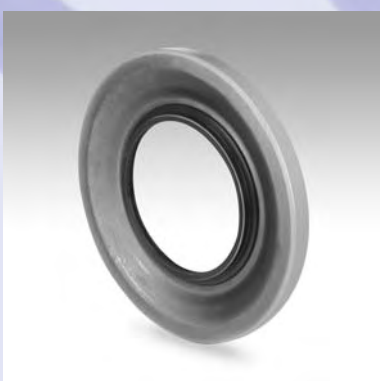
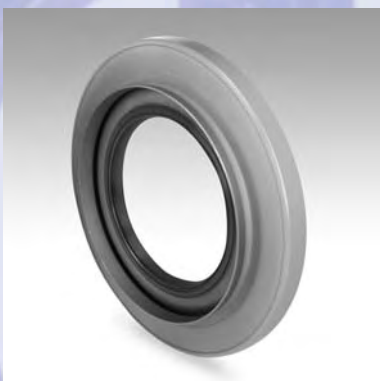

Dear Customers,

There is a lot to be said about radial oil seals. Much is technical, much scientific and much quite complex. If we were to present all of this here, we would end up with a breadth and depth extending far beyond what is really essential.

The essential is and remains: **the best products and the maximum processing reliability for your own individual applications.**

Accordingly, at this point we will be concentrating on the essential. We will be bringing you fully up to date with developments and presenting you with brief details of our radial oil seals in concentrated form.

However, it goes without saying that if you require any further details or should have any related questions, please do contact us and we will be happy to support you.

Your Dichtungspartner Hamburg team.



What are radial oil seals?

Radial oil seals are used to seal machine housings to prevent them being impaired in their function due to contained elements escaping. These include rotating machine elements (internal impairment) and dirt contamination (external impairment).

The choice of proper seal depends on the predominant operating parameters. Apart from the operating medium, operating temperature, rotational speed of the shaft and the pressure involved, these parameters also include the environmental conditions on the atmospheric side.

The radial oil seal consists of an elastomer component, a reinforcing ring and a spring. Specifically:

- The external surface guarantees reliable static sealing. It secures the radial oil seal in place in the casing.
- The external cover consists either of an elastomer or metal material.
- The reinforcing ring provides the radial oil seal with the required stability. The sealing lip is also pre-tensioned by a spring. This guarantees that the sealing lip makes secure radial contact right around the shaft. A protective lip is also available as an option, preventing the penetration of dirt and dust from the outside.

The other special advantage of the radial oil seal is that with its simple construction it is easy to install or remove.

What is the purpose of the oil seal?

The function of radial oil seals is to guarantee functional tightness, and therefore guarantee the reliability of the process as a whole. The aim is to keep secondary mechanical influences on the shaft to a minimum, so as to reduce the generation of heat and loss of performance within the sealed environment to the lowest possible level.

Where do we find oil seals in use?

Radial oil seals are used to seal rotating machine elements such as axles, hubs and shafts. They are used in a large number of sectors, including:

- transmission technology
- the agricultural and construction machinery industry
- domestic and industrial washing machines
- the wind power industry
- shipbuilding
- the pump industry
- rolling mills.

What standards are applicable?

Dichtungspartner Hamburg's radial oil seals comply with the DIN 3760 standard.

What construction types are there?

We differentiate between three basic types:

1. Construction type A features an elastomer external cover guaranteeing outstanding static sealing properties.
2. Construction type B is characterised by a metallic external surface which guarantees that the seal is seated firmly and precisely within the casing.
3. Construction type C - used in conjunction with construction type B - provides the degree of enhanced rigidity necessary for more demanding installation conditions and the more severe operating conditions, through the use of a reinforcing ring.

Surfaces and materials

What external surface finishes are available?

For the most part, our radial oil seals are available with an elastomer external cover or an AW external surface. We also produce combinations of these in the form of special designs for special requirements.

Rubber-enclosed external surface, construction types A and AS

Radial oil seals of construction type A often feature a smooth external cover in an elastomer material. This guarantees static tightness in the casing bore, even in critical situations. Also available with an AS protective lip.

Properties and applications:

- Excellent static sealing.
- Can be used with split casings, with any edge break or offset ends.
- With light metal casings susceptible to a high degree of heat expansion (casings with a greater expansion coefficient than steel).
- With thin-flowing or gaseous media.
- For pressurised applications within the limiting operating parameters.
- Sealing for greater degrees of surface roughness.
- Avoids the creation of frictional corrosion.
- Avoids damage to the casing bore during assembly and dismantling.

Grooved, rubber-enclosed external surface: construction type AW

To reduce compression force and to improve static tightness, the elastomer external cover is peripherally grooved.

Properties and applications:

- Easier to install due to lesser compression force.
- Reliable static sealing, especially for casings generating greater amounts of heat.
- Avoids the radial oil seal being left in an offset position.

Metallic external surface, construction types B and BS

With radial oil seals of construction type B, the smooth metallic external surface of the reinforcing ring has been finely ground, drawn or turned, as opposed to covered. Also available with BS protective lip.

Properties and applications:

- Firm and precise seating in the bore.
- More cost-effective, due to reduced proportion of elastomer.
- External surface provided with a narrower press fit tolerance.
- Good surface quality required for casing bore.
- Not suitable for use in split casings (also with seal-lock coating, only suitable for use in split casings to a limited extent).
- Where the casing generates a lot of heat, rough bore surfaces, pressurised applications or thin-flowing creeping media, an additional sealing compound should be applied to the external surface.

In order to prevent corrosion, after final processing the metallic external surface is coated with anticorrosion oil or has a thin coating of wax applied to it.

Metallic external surface with reinforcing ring, construction types C and CS

Radial oil seals of construction type C feature the same smooth and metallic external surface as those of construction type B. They can be provided with the metallic reinforcing ring and are also available with a CS protective lip.

Properties and applications:

- In more demanding installation conditions, heavy-duty operating conditions and for larger dimensions.
- Radial oil seals of construction type C offer greater rigidity than radial oil seals of construction type B.
 - Construction type C is extremely sensitive to installation faults.

Partially rubber-enclosed external surface: construction type A/B

Special version of external surface of radial oil seal. This combines the advantages of construction types A and B. Construction type A/B can also be used with casings subject to greater degrees of heat expansion and split casings. Construction types A/BS and AW/BS are also possible.



What additional sealant materials are used?

For enhanced static sealing in the casing bore, radial oil seals with a metallic external surface are frequently coated with sealing lacquer or sealing compound. Waxes or sealing lacquers are applied to protect against corrosion.

The sealing lacquer smoothes out processing traces on the external surface of the radial oil seal as well as any unevenness in the casing bore, as well as dealing with greater degrees of heat expansion. It also protects against damage to the casing bore during installation or dismantling.

Sealing lacquers are available in a variety of colours.

What material is used for springs?

The material normally used for standard springs is unalloyed spring steel to DIN EN 10270-1.

What materials are used for the reinforcing ring casing?

The standard material used is unalloyed steel to DIN EN 10139. Stainless and acid-resistant steel is used as a special material.

What materials are used for radial oil seals?

Depending on construction type and area of application, there is a variety of standard and special materials available for radial oil seals.

Elastomer materials are designated in accordance with the relevant DIN ISO 1629 and ASTM D 1418 abbreviations. Chemically produced synthetic rubber is used as the basic material for elastomer materials for radial oil seals. The individual elastomers are differentiated by their basic polymer.

The finished material is produced by mixing the basic elastomer with the corresponding auxiliary processing materials, vulcanisation materials, fillers, accelerators, softening agents and other additives. With this as the basic procedure, it is possible to adjust the desired material properties to allow for the production of both standard materials and special mixtures.

The radial oil seal is shaped by means of a vulcanisation process. The reinforcing ring is bonded to the elastomer component and the plastic and rubber mixture develops into its rubber-elastic state. The radial oil seal now achieves its final mechanical properties.

The sealing edge has already been created in the moulding tool or is parted off at this point. The spring is then fitted.



Material properties

What properties do the standard materials display?

Radial oil seals are available in two standard elastomer materials and two PTFE materials. We can supply both either immediately from our stores or at short notice.

NBR Acryl Nitrile Butadiene Rubber

- The material most frequently used for radial oil seals. Good mechanical properties, a high degree of resistance to mineral-oil-based lubricating oils and lubricating greases. Good resistance to fuels can normally only be achieved from special mixtures.
- Properties are primarily determined by the proportion of ACN. A low proportion results in a high degree of flexibility at low temperatures, however restricted resistance to oils and fuels. As the proportion of ACN is increased, flexibility in cold conditions is reduced while resistance to oil and fuels rises.
- The standard NBR material for radial oil seals displays an average proportion of ACN, with these balanced properties covering a wide range of applications. Mechanical-technological values are high: a high degree of resistance to abrasion and good resistance to mineral-oil-based lubricating oils and greases, hydraulic pressure oils H, H-L, H-LP, non-flammable pressurised fluids HFA, HFB, HFC, aliphatic hydrocarbons, silicone oils and silicone greases, water temperature up to approx. +80°C.
- NBR provides no resistance in aromatic and chlorinated hydrocarbons, polar solvents, fuels with a high aromatic content, glycol-based brake fluids and non-flammable HFD pressurised fluids.
- While the degree of resistance to ozone, weathering and ageing is low, in most cases this does not have a disadvantageous effect, for example when the material is treated with a coating of oil.

FPM - Fluorine Rubber

- Outstanding resistance to temperature and chemicals, outstanding resistance to ageing and ozone and low level of gas permeability, self-extinguishing reaction to fire.
- Optimum resistance properties in mineral oils and mineral greases, synthetic oils and synthetic greases. Similar properties in aliphatic, aromatic and chlorinated hydrocarbons, fuels and non-flammable pressurised fluids HFD, and many organic solvents and chemicals.
- Provides no resistance in hot water and steam, polar solvents, glycol-based brake fluids and low-molecular organic acids.

PTFE - Polytetrafluoroethylene

- Fluorinated plastic, physiologically non-harmful. Provides an almost universal range of resistance to chemicals, a wide thermal range of application (-90°C to +250°C) and a very low abrasion coefficient. Very high resistance to ozone, weathering and ageing. For radial oil seals, use is normally made of PTFE compounds with filler materials such as carbon, graphite or glass fibre.
- PTFE is used for sealing lips, coatings on sealing lips and entire radial oil seals, as soon as specific demands are made in terms of media resistance, thermal resistance, low abrasion or greater pressure and rotational speed.





What properties do the special materials display?

The special materials are used for special peripheral conditions.

HNBR - Hydrated Acryl Nitrile Butadiene Rubber

- Improved resistance to heat, ozone and ageing.
- Good mechanical properties, for example resistance to wear.
- Media resistance properties comparable with NBR.

NBR High Nitrile

- Higher resistance to oil and fuels than standard NBR.

NBR High Temperature

- Wider temperature application range than standard NBR, can be used at constant temperatures of up to +120°C.

NBR Low Temperature

- Wider minus temperature application range, can be used at temperatures between -50°C and +90°C.

NBR Graphite / NBR MoS₂

- The addition of certain filler materials provides optimised-abrasion running properties.

MVQ - Silicone Rubber

- Wider range of thermal application, outstanding resistance to ozone, weathering and ageing.
- Restricted mechanical properties.
- Generally physiologically non-harmful.
- Can be used in temperature ranges from -50°C to +200°C.
- Resistant to aliphatic engine and transmission oils, animal and plant oils and fats.
- No resistance to fuels, aromatic mineral oils, steam, silicone oils and silicone greases, and to acids and alkalis.

ACM - Acrylate Rubber

- High resistance to engine, transmission and ATF oils.
- Range of application between NBR and FPM.
- Can be used at temperatures between -25°C and +150°C.

EPDM - Ethylene Propylene Diene Rubber

- Good resistance in hot water and steam, detergents, caustic potash solutions, silicone oils and silicone greases, many polar solvents and many diluted acids and chemicals.
- Wide range of thermal applications.
- Totally unsuitable for use with lubricants and fuels.

Sealing mechanism



The sealing mechanism: how does this behave in terms of static tightness at the external surface?

The primary function of the radial oil seal is to guarantee static tightness in the casing bore.

The other requirements imposed on the external surface:

- To guide and guarantee the secure seating of the radial oil seal in the bore.
- To facilitate assembly by means of chamfers and curvatures.
- To provide compensation for gaps by means of a variety of heat expansion coefficients.

In the final analysis, the selection of the correct external surface depends on the specific application and the predominating operating conditions.

What is the dynamic sealing mechanism?

The functional principle by which the radial oil seal operates is that the elastomer sealing edge floats on the rotating surface of the shaft. The sealing edge is pressed against the surface of the shaft in a radial direction, as the internal diameter of the sealing lip in its tension-free state is smaller than that of the shaft diameter.

The radial force generated on the contact area is supported by means of a metallic screw tension spring to counteract the gradual decrease in the radial force.

The sealing effect at the elastomer sealing edge is achieved for the functional statuses of the shaft at a standstill and for the rotating shaft, and depends on the following parameters:

- the geometry of the sealing lip
- the properties of the elastomer material
- the design of the spring
- the surface finish of the shaft
- the lubrication status.

What provides the sealing effect with the shaft at a standstill?

In this case, it is provided by the radial contact pressure of the sealing lip exerted on the twist-free milled surface of the shaft. A radial force exerted on the shaft. The contact pressure against the sealing lip is achieved by means of pre-tensioning and is supported by the screw tension spring. The release of the elastomer pre-tensioning effect during operation is dependent on the operating parameters.

What provides the sealing effect with the shaft turning?

The rotational movement of the shaft produces a hydrodynamic effect. This results in the sealing lip floating over the film of lubricant formed by the medium to be sealed. This protects the sealing lip from premature wear and thermal destruction.

What is the reaction to permitted speeds and rotational speeds?

In order to prevent excessively high temperatures at the sealing lip which might result in a hardening of the elastomer or the formation of oil carbon deposits the rotational speed must be limited. For shafts of greater diameter, higher rotational speeds are permitted than for shafts of lesser diameter. The reason for this is that the shaft cross-section increases in relation to the square of the diameter, and this gives rise to considerably more favourable possibilities for heat dispersal.



What role is played by the temperature?

As a result of the rotation of the shaft and the friction this creates at the sealing lip, the actual temperature at the sealing lip is higher than in the oil sump. This temperature differential represents the excess temperature. It is dependent on the following factors:

- rotational speed
- lubrication status / oil level
- heat dispersal
- pressure load
- surface finish of the shaft
- the material of the radial oil seal.

As the rotational speeds increase, the excess temperature at the sealing lip rises correspondingly. If the maximum permitted operating temperatures for the various elastomer materials are exceeded, this gives rise to premature hardening and increased wear.



What is the reaction to the media to be sealed?

The chemical resistance of the radial oil seal to the media in use has a crucial effect on the service life of the seal.

- To seal aggressive media, for many application cases construction types A/AS in the material FPM are more suitable than construction types in NBR.
- Radial oil seals in FPM withstand higher chemical and thermal loads.
- Construction types A/AS equipped as standard with stainless and acid-resistant steel springs, with the metallic reinforcing ring provided with an elastomer coating.
- For even greater requirements in terms of media resistance, we recommend the construction types CV 20 and EPTO.
- For mineral oil-based oils and fats, a good level of resistance is provided by the standard materials NBR and FPM. For synthetic oils and fats, resistance problems might possibly arise due to a variety of factors.

Installation parameters

Friction statuses and lubrication

In the interaction of the machine components of the shaft, radial oil seal and lubricant, we have three components or materials coming together. This gives rise to a tribological system. At any point of friction, the lubricant is of equal status with the solid components. It influences the operating reliability and service life of the tribological system to a great extent.

1. Dry running

Under no circumstances must the shaft be allowed to rotate against the radial oil seal without lubrication. Accordingly, on assembly the sealing lip of the radial oil seal must be lightly greased.

Dry-running applications call for special construction types and materials, such as radial oil seals with a PTFE sealing lip.

2. Greasing

Where lubrication is purely by greasing, the dispersal of friction heat is considerably less than in the case of oil lubrication. This type of greasing should only be used with slowly rotating shafts.

For sealing slowly rotating shafts, the space between the radial oil seal and the bearing should be almost completely filled with grease. If there is no suitable lubricating grease available, we recommend using a radial oil seal with a PTFE sealing lip.

3. Sealing media with poor lubricating properties

In this case, to achieve adequate lubrication of the sealing edge, a grease filling between the sealing and the protective lip (maximum two thirds of the space) must be provided. Even more effective is a pair of radial oil seals arranged one after the other with an intermediate grease filling (maximum two thirds) to make secondary lubrication possible.

4. Hydrodynamic sealing aids

Where the normal feed effect of the radial oil seal is inadequate, so-called "rifling" can be used as an additional hydrodynamic sealing aid. This takes the form of raised return feed ridges. The way in which the rifling works corresponds to that for a simple threaded shaft seal.

Pressure as an operating parameter

1. Non-pressurised operation

Radial oil seals are generally designed for non-pressurised operation.

2. Operation under pressure

The load combination of pressure and rotational speeds is crucial for the selection of the correct radial oil seal ring.

3. Pressure load for standard construction types

Standard radial oil seals are designed to still be adequate for very low pressures and seal spaces with slight pressure differentials, for containing fluids, greases and air.

What is achieved by construction type V as a pressure-bearing version?

We recommend construction type V for pressure differentials greater than 0.5 bar, pulsed pressures and vacuum applications.

This construction type is designed with a short reinforced sealing lip with a metal cage below it. As a result of the pressure, the increase in contact force is reduced, with the greater abrasive effect and premature wear being reduced.

What is the function of supporting rings?

Pressure differentials greater than 0.5 or can also be sealed using a standard radial oil seal and an additional steel supporting ring. This combination caters for pressures depending on speed of up to around 10 bar. Only construction types without a protective lip can be used.

Everything you need to know about the installation space

1. The shaft

The shaft is a crucial element in the rotation-sealing system. It must fulfil a number of technical requirements if it is to guarantee an effective sealing effect.

The exact design of the shaft in the running surface area of the radial oil seal's sealing edge is also crucial for the service life and sealing function of the rotation-sealing system.

2. Tolerances (DIN 3760)

ISO Tolerance Range h11 should be applied for the shaft diameter d1 in the running surface area of the radial oil seal's sealing edge. Tolerance Class IT 8 (DIN ISO 286) is required for the roundness of the shaft.

3. Surface finish of the shaft

The shaft must be processed so that it is round at its running surface area. If the surface of the shaft is too rough this will result in premature wear in the sealing edge.

4. Surface hardness of the shaft

Another factor crucial for the service life of the sealing point is the hardness of the running surface on the shaft. In terms of surface hardness, an effective hardening depth of at least 0.3 mm is required.

The decision on the suitability of individual shaft surfaces (chrome-plated, cadmium-plated, nitration-hardened, phosphatised) must be taken on the merits of each individual case.

5. The running surface area

The running surface area must be specified with reference to the width of the stipulated seal.

6. Processing the shaft surface

In the running surface area of the sealing edge, the shaft must be milled twist-free and completely circular if the sealing function is to be guaranteed.

The following processing techniques can be used:

- plunge-cut grinding
- hard turning

7. Twist-free shaft surface

It is essential that the shaft's running surface area has been produced completely twist-free. Twist-free means that the traces left by processing do not run off at any angle.

8. Shaft materials

The standard tempering steels are suitable as shaft materials, as long as the values for surface hardness are observed. Hard-chrome plated shafts and plastic shafts are of limited suitability. The following statement applies generally for all shaft surface materials: the stipulated values in terms of quality and hardness must be observed.

If the shaft is not provided with the required running surface properties, then use must be made of corresponding shaft protection sleeves.

Dichtungspartner Hamburg offers you a range of shaft protection sleeves in all dimensions and in a variety of materials.

9. Radial run-out

Any radial run-out or dynamic eccentricity in the shaft must be kept to an absolute minimum.

Accordingly, the radial oil seals should be fitted in the immediate vicinity of the bearing and bearing play minimised.

10. Shaft chamfer

The sealing lip must not be damaged on installation, to ensure that the sealing lip is not angled over.

11. Damage to the shaft

It is essential that no damage of any kind is caused to the running surface of the shaft. We recommend that shafts be carefully protected in transit between production and assembly. Transportation devices or specially cast or slide-over protective plastic sleeves are suitable for the purpose.

Mounting conditions

About the casing bore

The design and construction of the casing bore are crucial for static sealing. The following conditions must be fulfilled if a secure and tight seating in the casing bore is to be achieved:

- tolerances
- casing dimensions
- chamfer on the casing bore
- surface quality of the casing bore

The coaxiality of the casing bore results in uneven distribution of the contact force at the circumference. Numerous disadvantageous processes arise out of this situation. Accordingly, any discrepancy in coaxiality must be kept to a minimum.

In the selection of construction type for the radial oil seal and the material of the casing, consideration must be given to the heat expansion coefficient in all cases.

About heat expansion

The heat expansion properties of the material of the radial oil seal and of the casing are important for the static sealing process in the casing bore. From the thermal point of view, casings made of steel or cast iron offer the greatest advantages, used in combination with a radial oil seal with a rubberised external cover.

About an offset angled position

The installed radial oil seal must be centred as far as possible and installed perpendicular to the shaft.

About the degree of rigidity

Casings are frequently designed with thin walls. When fitting radial oil seals into thin-walled casing bores or seating recesses of lesser rigidity, the problem of the casing being severely expanded can arise. We recommend the use of radial oil seals with a rubberised external cover or using another casing bore tolerance.

Split casings

Thanks to the good elastic malleability of elastomer and of the mould filler, the required degree of static sealing can be achieved with construction type A. This means that even split casings featuring a variety of split levels and even an offset separation joint can be reliably sealed.





All about installation

Proper installation is crucial. Radial oil seals are installed in accordance with DIN 3760.

Prior to installation, both the installation space and the radial oil seal should be carefully cleaned.

Ideally, a hydraulic or mechanical pressing device should be used to push the radial oil seal into the casing bore. The pressing tool should be held in its final position for some time. Where the radial oil seal has to be guided over sharp-edged shoulders, the appropriate installation sleeves should be provided. The sleeve itself must not display any damage or rough surfaces. For the radial oil seal to be securely seated, the external cover must be located completely within the casing bore.

All about special applications

1. Under-pressure or vacuum sealing

To seal a shaft against under-pressure use is made of radial oil seals corresponding to the pressure gradient at the sealing lip on the atmospheric side. Where grease is used, the outer radial oil seal must also be installed with its sealing lip facing out to the atmospheric side.

2. Separating two media

To separate two spaces containing different media one from the other, use is made of two radial oil seals with their sealing lips facing in opposite directions.

A further option for separating two media at lower to medium rotational speeds is the use of our construction types AD and BD, which in their design combine two sealing lips arranged in opposite directions within a single seal.

3. Sealing in the presence of severe external dirt/contamination

The effects of external dirt and contamination result in premature wear to both seal and shaft surface. Depending on the type and quantity of the contamination arising, protection should be provided for the sealing lip. Under extreme conditions such as with agricultural and construction machinery cassette seals should be used.

4. Sealing with contaminated media

Contaminated media or media containing abrasive materials cause a high degree of wear in the area of the seal. This can be countered by installing a second seal before the first, or with the use of our VRM axial seal.







Correct storage of elastomer products

In their specific properties, elastomers remain practically unchanged for a period of years, as long as certain minimum requirements in terms of their storage conditions are observed (refer to DIN 7716 and ISO 2230).

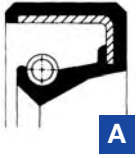
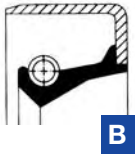
- Seals should be stored free of tension.
- They should be protected from any pronounced change of air. We recommend storage in a polyethylene bag or in airtight containers.
- Storage conditions cool, dry, low-dust and only moderately ventilated.
- Storage temperature not below -10°C and not above $+20^{\circ}\text{C}$.
- Heat sources/radiators should be screened and kept at a distance of at least one metre.
- Relative humidity should not exceed 65%.
- Strong lighting (above all UV radiation and direct sunlight) should be avoided.
- No use should be made of electrical equipment generating ozone.

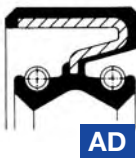
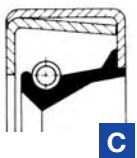
Seal types

Overview of most popular oil seal types acc to DIN 3760/3761

Application	Description	Application	Description
 A	rubber version with single lip	 B	metal cased open
 AS	rubber version with sealing and dust lip	 BS	metal cased open with dust lip
 AD	rubber version with 2 lips and 2 springs	 C	metal cased closed
 AW	rubber version with sealing lip and corrugated profile	 CS	metal cased closed with dust lip
 ASW	rubber version with sealing lip and dust lip and corrugated profile	 BD	metal cased open with lips
 A/B	seal with combined elastomer/metal outer cover	 A/BS	seal with combined elastomer/ metal outer cover with dust lip

Complimentary definitions

- RD Right hand helix
- LD Left hand helix
- WD Double helix
- SF Special design
- OF Without spring
- V Reinforced seal lip
- LA With sealantfilm
- W Corrugated profile





OEM

									OEM-NO			
dph-no	dim 1	dim 2	dim 3	Style	Material	dph oil seal no.	Application	Type	OEM-NO	Elring	Corteco	Reinz
109140	82,00	105,00	12,00	AS W LD	FPM	3914	crankshaft	ALFA	60517110	232300	12013892	
109141	48,00	66,65	10,00	AS RD W	MVQ	37651	crankshaft	ALFA	60524745		12013046	
109142	55,00	70,00	8,00	AS	NBR	50342	wheel hub	ALFA	60709430		12011182	
109143	42,00	62,00	10,00	AS RD	ACM	35050	crankshaft	ALFA	60735515		12013896	
109145	84,00	105,00	12,00	AS W LD	MVQ	50510	crankshaft	ALFA	119 00 01 177 00		12015180	
111787	30,00	43,00	8,00	A/BS RD	FPM	111786	camshaft	ALFA	6080 5219	440730	12001538	
80689	52,00	72,00	10,00	A LD	MVQ	80688		BMW	11 11 0 001 122			
94549	80,00	100,00	10,00	A LD SP	ACM	94548		BMW	11 11 1 261 739			
94550	80,00	100,00	10,00	A LD SP	ACM	94548		BMW	11 11 1 337 674			
115419	32,00	45,00	6,00	AS RD SP	FPM	115434	crankshaft	BMW	11 11 1 485 171			
115418	91,00	111,00	10,00	A/BS LD	FPM	115433		BMW	11 11 1 492 244			
115397	65,00	79,00	20,00	AS RD	PTFE/AEM	115400	crankshaft	BMW	11 11 7 511 395	257400	20033890	81-34057-00
84169	38,00	50,00	7,00	ASW WD	FPM	36116		BMW	11 12 1 265 435		12015381	
116110	38,00	50,00	7,00	ASW WD	FPM	36116	engine	BMW	11 12 1 284 154	586668		
19977	38,00	50,00	7,00	AS W WD	FPM	36116	engine	BMW	11 12 1 285 609	586668	12015381	81-24641-10
96322	42,00	62,00	10,00	AS RD	ACM	35050	crankshaft	BMW	11 14 1 255 010		12013896	
94552	28,00	47,00	7,00	A W RD	ACM	94551		BMW	11 14 1 255 011			
109060	90,00	110,00	12,00	AW/BS LD	FPM	15246	crankshaft	BMW	11 14 1 255 012		12012579	
114571	35,00	55,00	12,00	AS W RD	ACM	36204	crankshaft	BMW	11 14 1 255 014		12013416	
109114	80,00	100,00	13,00	A/BS W LD	MVQ	37509	crankshaft back	BMW	11 14 1 255 015	128210	19030094	81-18304-00
84170	48,00	65,00	10,00	AW/BS RD F	FPM	36203	crankshaft	BMW	11 14 1 265 431	022918	12012045	
37452	28,00	40,00	7,00	A RD W	FPM	37451	camshaft	BMW	11 14 1 271 415	562939	20020463	81-19159-10
36212	48,00	65,00	10,00	AW/BS RD F	FPM	36203	crankshaft	BMW	11 14 1 274 346	586676	12012045	81-17404-50
84171	90,00	110,00	12,00	AW/BS LD	FPM	15246	crankshaft	BMW	11 14 1 275 161		12012579	
61330	48,00	65,00	9,00	AW/BS RD	FPM	61331	crankshaft	BMW	11 14 1 275 466	586676	12012045	
84172	35,00	55,00	12,00	AS W RD	ACM	36204	crankshaft	BMW	11 14 1 278 108		12013416	
95835	44,00	60,00	10,00	AS W RD	FPM	80654	crankshaft	BMW	11 14 1 308 342	761796	12014608	
104477	44,00	62,00	10,00	A/BS RD W	FPM	104499	crankshaft	BMW	11 14 1 312 007	757217		81-36496-00
114591	44,00	60,00	10,00	combi	PTFE	114335	crankshaft	BMW	11 14 1 435 848		20019548	81-28498-10
96714	44,00	60,00	10,00	combi	PTFE	114335	crankshaft	BMW	11 14 1 439 570	214680	20019548	81-28498-10
48086	90,00	110,00	12,00	AW/BS LD	FPM	15246	crankshaft	BMW	11 14 1 706 785	702994	12012579	81-20745-40
15256	90,00	110,00	12,00	AW/BS LD	FPM	15246	crankshaft	BMW	11 14 1 706 999		12012579	
115878	28,00	40,00	7,00	A RD W	FPM	37451	camshaft	BMW	11 14 1 707 107	562939		
36214	35,00	55,00	12,00	AS W RD	ACM	36204	crankshaft	BMW	11 14 1 709 632	587044	12013416	81-19886-10
112638	100,00	125,00	13,00	A/B LD	FPM	112637	crankshaft back	BMW	11 14 1 710 247	818399	20026342	

dph-no	dim 1	dim 2	dim 3	Style	Material	dph oil seal no.	Application	Type	OEM-NO	Elring	Corteco	Reinz
93722	55,00	72,00	10,00	AW/BS RD	FPM	93721	crankshaft	BMW	11 14 1 713 722	818364	20020462	
114622	100,00	125,00	13,00	A/B LD	FPM	112637	crankshaft back	BMW	11 14 1 713 730	818399	20026342	81-27373-00
80653	42,00	52,00	7,5/8	A/BS W RD	FPM	80652	crankshaft	BMW	11 14 1 714 617	748889	12014607	81-27556-00
115876	42,00	62,00	12,00	AW/BS RD	FPM	15245	crankshaft	BMW	11 14 1 715 098	586641		
115877	42,00	62,00	12,00	AW/BS RD	FPM	15245	crankshaft	BMW	11 14 1 715 099	586641		
15257	42,00	62,00	12,00	AW/BS RD	FPM	15245	crankshaft	BMW	11 14 1 715 100	586641		81-16004-10
109119	42,00	62,00	10,00	AS RD	ACM	35050	crankshaft	BMW	11 14 1 715 101		12013896	
80655	44,00	60,00	10,00	AS W RD	FPM	80654	crankshaft	BMW	11 14 1 721 560	761796	12014608	81-28498-00
116111	55,00	72,00	10,00	AW/BS RD	FPM	93721	crankshaft	BMW	11 14 1 725 994	818364	20020462	
109120	90,00	110,00	12,00	AW/BS LD	FPM	15246	crankshaft	BMW	11 14 2 245 364	702994	12012579	81-20745-40
114670	48,00	65,00	10,00	AS W RD	AEM/PTFE	114341	crankshaft	BMW	11 14 2 247 117	050260	20019549	
114778	90,00	110,00	12,00	AS WD combi	PTFE/AEM	114405	crankshaft	BMW	11 14 2 247 164		20019546	
96713	48,00	65,00	10,00	AS W RD	AEM/PTFE	114341	crankshaft	BMW	11 14 2 249 532	050260	20019549	81-17404-10
115421	75,50	107,00	8,00	AS W LD	FPM	115437	crankshaft	BMW	11 14 7 790 960		19026734	
115420	38,00	50,00	6,20	AS RD	FPM	115436	crankshaft	BMW	11 14 7 790 962	135140	19033909	
33252	7,00	16,00	7,00	A	NBR	17345		BMW	11 31 1 256 860			
33253	15,00	24,00	7,00	A	NBR	17403	differential	BMW	23 11 1 006 124			
37121	15,00	21,00	5,00	BS	NBR	37114	gearbox	BMW	23 11 1 204 223		01019151	81-24010-00
51728	30,00	42,00	7,00	AS RD	FPM	51727	manual transmission	BMW	23 11 1 228 314		12011839	
96051	30,00	42,00	7,00	A/B	ACM	96051	gearbox	BMW	23 11 1 228 314			
82102	30,00	42,00	7,00	AS RD	ACM	82102	gearbox	BMW	23 11 1 228 314	277142		
116030	15,00	21,00	5,00	BS	NBR	37114	gearbox	BMW	23 11 1 228 333			
116031	40,00	55,00	7,00	A	NBR	18074	crankshaft	BMW	23 11 1 230 087	277150		
33254	30,00	42,00	7,00	A	NBR	17728	crankshaft	BMW	23 12 1 201 279	203408		
33255	38,00	52,00	10,00	B blue	NBR	51486	manual transmission	BMW	23 12 1 201 390	039780		
116032	30,00	42,00	7,00	AS RD	FPM	51727	manual transmission	BMW	23 12 1 202 715	277142		
116033	40,00	55,00	8,00	AS W LD	ACM	50854	gearbox automatic	BMW	23 12 1 202 727	242993		
95589	30,00	48,00	10,00	A RD	ACM	95588	gearbox	BMW	23 12 1 204 211	038938		81-35284-00
84217	30,00	42,00	7,00	AS RD	FPM	51727	manual transmission	BMW	23 12 1 205 186	277142	12010674	
50855	40,00	55,00	8,00	AS W LD	ACM	50854	gearbox automatic	BMW	23 12 1 205 340	242993		81-35286-00
48411	35,00	52,00	7,00	A RD	FPM	48410	automatic gearbox	BMW	23 12 1 220 619		01019289	
116034	15,00	21,00	5,00	BS	NBR	37114	gearbox	BMW	23 12 1 222 677	327298		
113093	40,00	55,00	8,00	AS W LD	ACM	50854	gearbox automatic	BMW	23 12 1 222 771			
33256	40,00	55,00	7,00	A	NBR	18074	crankshaft	BMW	23 12 1 230 087	277150		
33257	16,00	24,00	7,00	A	NBR	17428	transfer gearbox	BMW	23 12 1 232 248			

									OEM-NO			
dph-no	dim 1	dim 2	dim 3	Style	Material	dph oil seal no.	Application	Type	OEM-NO	Elring	Corteco	Reinz
94560	26,50	40,00	7,00	A RD	ACM	94558		BMW	23 12 1 232 249			
33258	16,00	26,00	7,00	A	NBR	19104		BMW	23 12 1 233 386			
98438	15,00	21,00	5,00	BS	NBR	37114	gearbox	BMW	23 12 1 282 394	327298		
94559	26,50	40,00	7,00	A RD	ACM	94558		BMW	23 12 1 338 726			
94561	16,00	26,00	7,00	A	NBR	19104		BMW	23 12 1 338 740			
116035	10,00	18,00	6,00	A	NBR	17356	crankshaft	BMW	23 12 1 451 030	011304		
94564	22,00	35,00	7,00	A W RD	ACM	94563		BMW	23 12 1 451 151			
94562	16,00	24,00	6/6,5	AS	NBR	48059	fuel injection pump	BMW	23 12 1 451 156			
33259	10,00	18,00	6,00	A	NBR	17356	crankshaft	BMW	23 12 1 451 157	011304		
33260	8,00	14,00	4,00	B	NBR	33261	speedometer drive	BMW	23 12 1 490 192		01033871	
116036	30,00	48,00	10,00	A RD	ACM	95588	gearbox	BMW	23 12 1 606 122	038938		
116037	30,00	48,00	10,00	A RD	ACM	95588	gearbox	BMW	23 12 1 606 123	038938		
37122	40,00	58,00	10,00	AS LD	MVQ	37116	gearbox	BMW	24 11 1 207 426			
84218	40,00	58,00	10,00	AS LD	MVQ	37116	wheel hub	BMW	24 11 1 215 465			
113094	52,00	68,00	8,00	AS LD SP	FPM	70208		BMW	24 13 7 509 504			
37117	40,00	52,00	7,00	A	MVQ	37111	camshaft	BMW	24 31 1 207 621			
48912	40,00	52,00	7,00	A RD	FPM	48911	gearbox	BMW	24 31 1 218 493			
33262	11,00	22,00	7,00	A	NBR	17366		BMW	24 34 1 203 237			
33263	10,00	18,00	5,00	A	NBR	19096		BMW	24 34 1 207 430			
33264	11,00	22,00	7,00	A	NBR	17366		BMW	24 34 1 207 763			
116038	30,00	42,00	7,00	A	NBR	17728	crankshaft	BMW	24 51 6 606 714	203408		
112517	10,00	18,00	5,00	AS	NBR	112519	gearbox	BMW	24 52 7 509 500		01033982	
4059	40,00	52,00	7,00	BS	NBR	37345	front axle	BMW	31 21 1 101 114			
116113	45,00	62,00	7,00	BS	NBR	37346	front axle	BMW	31 21 1 106 220	040673		
116039	40,00	52,00	7,00	BS	NBR	37345	front axle	BMW	31 21 1 106 225	039926		
116040	40,00	52,00	7,00	BS	NBR	37345	front axle	BMW	31 21 1 106 226	039926		
116041	40,00	52,00	7,00	BS	NBR	37345	front axle	BMW	31 21 1 106 227	039926		
116042	48,00	62,00	7,00	BS	NBR	19660	rear axle	BMW	31 21 1 118 478	277223		
116043	48,00	62,00	7,00	BS	NBR	19660	rear axle	BMW	31 21 1 119 139	277223		
80575	48,00	62,00	7,00	BS	NBR	19660	rear axle	BMW	31 21 1 119 200	277223		
116112	48,00	62,00	7,00	BS	NBR	19660	rear axle	BMW	31 21 1 125 912	277223		
4065	45,00	62,00	7,00	BS	NBR	37346	front axle	BMW	31 21 2 634 108	040673		
33265	28,00	38,00	7,00	A	NBR	17693	steering	BMW	32 11 1 104 719			
33266	18,00	30,00	7,00	A	NBR	17480	steering	BMW	32 11 1 110 269			
37118	28,00	40,00	7,00	AS	NBR	93614	crankshaft	BMW	32 13 1 111 871			

dph-no	dim 1	dim 2	dim 3	Style	Material	dph oil seal no.	Application	Type	OEM-NO	Elring	Corteco	Reinz
37119	18,00	30,00	7,00	AS	NBR	19193		BMW	32 13 1 111 908			
37120	18,00	30,00	7,00	AS	FPM	37113		BMW	32 13 1 123 773			
116114	45,00	62,00	7,00	BS	NBR	37346	front axle	BMW	32 21 2 634 108	040673		
33267	20,00	30,00	7,00	AS blue	NBR	17505	transfer gearbox	BMW	32 22 1 108 259			
33268	20,00	42,00	7,00	AS WD blue	NBR	48013	steering	BMW	32 41 1 117 621	277290		
116115	45,00	65,00	10,00	AW BS RD	FPM	95149	rear axle	BMW	33 12 1 202 121	216046	20020503	
116116	45,00	65,00	10,00	AW BS RD	FPM	95149	rear axle	BMW	33 12 1 202 124	216046		
116117	45,00	65,00	10,00	AW BS RD	FPM	95149	rear axle	BMW	33 12 1 202 125	216046		
37033	38,00	54,00	10/11	AS	ACM	94396	differential	BMW	33 12 1 202 126		01025572	
116118	45,00	65,00	10,00	AW BS RD	FPM	95149	rear axle	BMW	33 12 1 204 231	216046		
112419	45,00	65,00	10,00	AW BS RD	FPM	95149	rear axle	BMW	33 12 1 204 232	216046		
51407	45,00	75,00	10/8	A/BS RD	ACM	51406	differential	BMW	33 12 1 212 461		01027755	
116120	30,00	42,00	7,00	A	NBR	17728	crankshaft	BMW	33 12 3 004 336	203408		
33269	30,00	42,00	7,00	A	NBR	17728	crankshaft	BMW	33 12 3 004 337	203408		
84216	44,00	67,00	10,00	AS WD	ACM	84215	differential	BMW	33 13 1 206 111	095311	01020317	
93723	44,00	67,00	10,00	AS WD	ACM	84215	differential	BMW	33 13 1 214 100	095311	01020317	81-29411-00
116121	42,00	58,00	7,00	BS	NBR	37347	rear axle	BMW	33 41 1 106 213	040304		
4063	42,00	58,00	7,00	BS	NBR	37347	rear axle	BMW	33 41 3 404 161	040304	12012129	
82536	105,00	120,00	8,00	BS	NBR	81356	wheel hub	BPW	02 5664 04 00	495590		
82533	115,00	133,00	13,00	AS W WD	NBR	82532	wheel hub	BPW	02 5664 18 57	216320	01033476	
82537	125,00	143,00	13,00	AS WD W	NBR	80457	wheel hub	BPW	02 5664 26 57	817252	12015710	
82535	125,00	142,00	13,00	AS W WD	NBR	82534	crankshaft	BPW	02 5664 28 57	292650	01019878	
82078	145,00	167,00	13,00	AS WD W	NBR	80456	axle	BPW	02 5664 46 57	817260	12013359	
109146	115,00	136,70	8/12	AS SP	NBR	113537	axle	BPW	02 5664 55 64		01016766	
93811	115,00	136,70	8/12	AS SP	NBR	113537	axle	BPW	02 5664 57 00	495600	01016766	
82845	156,70	135,00	8/12	special	NBR	82844	crankshaft	BPW	02 5664 58 00		01026187	
113539	176,70	155,00	8/12	AS SF	NBR	113538	crankshaft	BPW	02 5664 59 00		01032459	
113541	160,00	188,00	14,00	AS W WD SP	NBR	113540	steering	BPW	02 5664 64 57	292660		
110008	117,50	158,00	17,80	A SP	NBR	113547	crankshaft	BPW	02 5664 68 00		01029718	
113548	117,50	158,00	17,80	A SP	NBR	113547	crankshaft	BPW	02 5664 74 00			
114744	72,00	92,00	13,00	SP	PTFE	114385		CATERPIL	7C6660			
114688	54,15	35,00	9,50	SP	PTFE	114354		CATERPIL	8C3100			
114566	35,00	22,00	8,00	SP	PTFE	114333		CATERPIL	8C5210			
114728	67,00	94,00	13,00	SP	PTFE	114373		CATERPIL	9Y9895			
111383	23,00	36,00	6/7	A W RD	NBR	111391		CITROEN	2109.40	131860	07015547	

									OEM-NO			
dph-no	dim 1	dim 2	dim 3	Style	Material	dph oil seal no.	Application	Type	OEM-NO	Elring	Corteco	Reinz
114557	29,85	47,00	11,30	combi	ACM	95498		CITROEN	3121.26	128240	20015497	
109147	35,00	47,00	7,00	AW RD	FPM/ACM	112614	crankshaft	CITROEN	7700 619 237		12013859	81-15855-40
114568	35,00	47,00	7,00	AS RD	MVQ	37506	crankshaft	CITROEN	7700 619 237 alt			
59258	35,00	50,00	7,00	A W RD	MVQ	59255	crankshaft	CITROEN	7910 006 487	293946		
109150	42,00	66,00	8/7	AS W RD	MVQ	59260	crankshaft	CITROEN	9606 8980			
109151	29,85	47,00	11,30	combi	ACM	95498		CITROEN	9608 0792		20015497	
114660	152,50	171,00	16,00	SP	PTFE	114422		CUMMINS	39823			
114601	45,00	65,00	10,00	SP	PTFE	114338		CUMMINS	200307			
114780	91,00	121,00	12,00	SP	PTFE	114406	crankshaft	CUMMINS	3004317			
114659	151,00	171,00	11,00	SP	PTFE	114421	crankshaft	CUMMINS	3006737			
114761	80,00	105,00	12,00	SP	PTFE	114396	crankshaft	CUMMINS	3010457			
114615	95,00	120,50	12,50	SP	PTFE	114409		CUMMINS	3010459			
114634	110,00	140,00	13,00	SP	PTFE	114415		CUMMINS	3016787			
114696	55,00	73,00	13,00	SP	PTFE	114358		CUMMINS	3016788			
114627	103,00	127,00	13,00	SP	PTFE	114412		CUMMINS	3020184			
114701	55,00	81,00	11,00	SP	PTFE	114360		CUMMINS	3020187			
114642	122,00	152,50	14,50	SP	PTFE	114418		CUMMINS	3023867			
114673	48,00	81,00	11,00	SP	PTFE	114343		CUMMINS	3078292			
114667	185,00	206,00	13,00	SP	PTFE	114425		CUMMINS	3082142			
114703	57,00	67,50	6,50	SP	PTFE	114361		CUMMINS	3627961			
114716	63,50	79,50	8,00	SP	PTFE	114366		CUMMINS	3900709			
114748	75,00	93,00	8,00	SP	PTFE	114387		CUMMINS	3921927			
114645	130,00	150,00	14,50	BS W SP	PTFE	112489		CUMMINS	3933262			
84614	80,00	95,00	8,00	A	NBR	35192	crankshaft	DAF	0010 588	043737	07013486	81-35088-00
84615	85,00	110,00	13/9,5	A	NBR	81336	front axle	DAF	0015 484		12013388	
109158	85,00	110,00	13/9,5	A	NBR	81336	front axle	DAF	0015 485		12013388	
84616	110,00	130,00	13,00	A	NBR	19880		DAF	0015 599			
118552	26,00	34,00	4,5/7	AS SF	NBR	116002	crankshaft	DAF	0066 322		01020066	
110002	85,00	125,00	12,00	SP	FPM	110004	differential	DAF	0077 479		01016687	
84618	48,00	75,00	8,00	B RD	FPM	4545	gearbox	DAF	0110 466	033472	12011307	
84619	17,00	28,00	7,00	B	NBR	37867		DAF	0110 732		12011351	
84622	25,00	47,00	10,00	A	NBR	68544	crankshaft	DAF	0119 198	038326	12010859	
114558	30,00	40,00	7,00	A	NBR	113776	crankshaft	DAF	0119 199	201006	12010879	
114521	17,00	28,00	7,00	AS	NBR	17448	crankshaft	DAF	0119 468	050300	12011112	
111591	25,00	35,00	7,00	B	NBR	4378	gearbox	DAF	0140 335	038083	12014616	

dph-no	dim 1	dim 2	dim 3	Style	Material	dph oil seal no.	Application	Type	OEM-NO	Elring	Corteco	Reinz
111583	85,00	105,00	10,00	AW/BS LD	FPM	82528	gearbox	DAF	0140 783	033464	12013757	
114735	70,00	90,00	10,00	AS W LD	FPM	47944		DAF	0140 784	348856	12014736	
94835	114,00	142/170	14/27	B SP	NBR	94834	wheel hub	DAF	0190 069		19031938	
94685	42,00	56,00	7,00	AS	NBR	94735	water pump	DAF	0213 966	344400		
109162	125,00	150,00	15,00	AS/BW LD	FPM	51252	crankshaft	DAF	0240 443			
82342	70,00	90,00	12,00	AS RD	ACM	82341	crankshaft	DAF	0240 631	760544		
114663	160,00	185,00	14,00	A WD	ACM	114423	crankshaft	DAF	0259 939		12015609	
118922	160,00	185,00	14,00	A WD	ACM	114423	crankshaft	DAF	0259 940		12015609	
82344	125,00	150,00	15,00	AS/BW LD	FPM	51252	crankshaft	DAF	0266 146			
82348	100,00	124,00	13,00	AW/BS LD F	FPM	82347	crankshaft	DAF	0281 986		12015531	
81801	125,00	160,00	17,00	KA SP	FPM	81798	axle	DAF	0292 766		01015140	
111669	65,00	90,00	10,00	BS WD	FPM	111748	crankshaft	DAF	0299 521		01029683	
82349	72,00	100,00	10,00	A	NBR	18646	crankshaft	DAF	0325 321		12011019	
114775	85,00	140,00	15/16,5	KA	FPM/NBR	114401	differential	DAF	0376 992		01017057	
114315	120,00	142/150,00	37,00	SP	NBR	114314	wheel hub	DAF	0500 162		01032389	
114772	85,00	110,00	12/16	AW/BS RD	FPM	114399	differential	DAF	0538 953			
82346	154,00	180,00	15,00	AW/BS LD F	FPM	82345	crankshaft	DAF	0558 114		12015530	81-28539-00
109164	80,00	100,00	10,00	A green	NBR	4306	front-/rear axle	DAF	0572 372			
114770	85,00	105,00	13,00	BS	NBR	32425	gearbox	DAF	0578 507		12011359	
111581	85,00	105,00	12/10	B	NBR	95872	gearbox	DAF	0585 373	033480	12011341	81-35091-00
114704	60,00	74,00	10/8	AS W LD	FPM	113749	gearbox	DAF	0585 910		12013365	
109165	48,00	65,00	10,00	B	NBR	81637	gearbox	DAF	0586 697	040991	12011331	
114671	48,00	75,00	8,00	B RD	FPM	4545	gearbox	DAF	0609 458	033472	12011307	
114766	85,00	105,00	10,00	AW/BS LD	FPM	82528	gearbox	DAF	0609 475	033464	12013757	
113946	100,00	135,00	13,00	AS WD	NBR	113945	wheel hub	DAF	0647 330		12015029	
114564	32,00	45,00	7,00	A	NBR	17829	wheel hub	DAF	0662 004		12000157	
81796	120,00	160,00	17,50	C SP	NBR	81799	axle	DAF	0678 157		01015143	
109166	154,00	180,00	15,00	AW/BS LD F	FPM	82345	crankshaft	DAF	0682 961		12015530	
51890	125,00	150,00	15,00	AS/BW LD	FPM	51252	crankshaft	DAF	0682 962	493360		
114717	63,50	102,50	6,6/14,8	AS W WD SF	FPM	114367	crankshaft	DAF	0691 048		01030337	
117067	25,45	44,43	5,1/6,1	AS WD	MVQ	116145	wheel hub	DAF	0692 009			
111584	48,00	69,00	10,00	B RD	FPM	47988	gearbox	DAF	0693 402		12011306	81-35078-00
114767	85,00	105,00	10,00	AW/BS LD	FPM	82528	gearbox	DAF	0693 928	033464	12013757	
114616	95,30	114,29	11,88	BS WD LA	FPM	96979	gearbox	DAF	0696 084		12012235	
114635	110,00	140,00	15,5/20	KA	FPM	114416	gearbox	DAF	0893 004		01019705	

									OEM-NO			
dph-no	dim 1	dim 2	dim 3	Style	Material	dph oil seal no.	Application	Type	OEM-NO	Elring	Corteco	Reinz
118373	100,00	120,00	12,00	AS	NBR	19863	crankshaft	DAF	1 602 361		12011209	
120080	134,00	161,00	16,00	A RD	NBR	120079	crankshaft	DAF	1 684 105			81-37174-00
120082	166,00	191,00	16,00	A LD	NBR	120081	crankshaft	DAF	1 684 106			81-37173-00
104115	70,00	90,00	10,00	AW/BS RD	FPM	114379	crankshaft	DAF	1226 734	763144	12014700	81-15287-00
114810	26,00	35,00	11,00	B OF SF blue	NBR	114809	crankshaft	DAF	1236 238		01027785	
81802	100,00	140,00	15/20,5	CS SP	NBR	81800	wheel hub	DAF	1238 034		12015758	
111373	105,00	150,00	12,00	BS SP	FPM	111386		DAF	1242 697			
109156	125,00	150,00	15,00	AS/BW LD	FPM	51252	crankshaft	DAF	1275 082	493360		81-24476-20
97821	154,00	180,00	15,00	AW/BS LD F	FPM	82345	crankshaft	DAF	1275 083		12015530	81-28539-00
104116	100,00	124,00	12,00	AS RD	FPM	95198	crankshaft	DAF	1275 084			81-29052-00
84770	100,00	140,00	15,5/20	KA	FPM	113947	wheel hub	DAF	1278 420		01015141	
114317	90,00	140,00	15,5/20	KA	FPM	114316	crankshaft	DAF	1278 421		01015529	
113949	100,00	150,00	15/20	KA SP	FPM	113948	crankshaft	DAF	1278 423		01015348	
111375	78,00	115,00	13/17	BS RD SP	FPM	111388	differential	DAF	1283 668		01017058	
111374	85,00	140,00	13/17	BS SP	FPM	111387	differential	DAF	1287 102		01027965	
114762	80,00	120,00	13/17	AW/BS RD	FPM	114397	differential	DAF	1287 103		01029753	
109610	100,00	140/166,00	16/22	SP	NBR	112832	ABS	DAF	1334 961		01026332	
109609	125,00	160/190,00	18/20	KA SP	FPM/PA	109760	ABS	DAF	1335 063		01026336	
97822	154,00	180,00	12,00	A/BS LD	AEM/PTFE	115386	crankshaft	DAF	1340 320	017590	20029771	81-28539-00
114620	100,00	124,00	12,00	AS RD SP	PTFE/ACM	114410	crankshaft	DAF	1340 321	493330	15027586	81-29052-10
117251	154,00	180,00	12,00	A/BS LD	PTFE/AEM	115386	crankshaft	DAF	1370 127	175990	20029771	
109157	120,65	146,05	12,70	A	NBR	84534	front axle	DAF	140 619			
114481	82,00	105,00	10,00	AS2	NBR	114447	wheel hub	DAF	1400 080		01034436	
116554	90,00	130,00	17,00	KA	NBR	113051		DAF	1404 690		19034570	
117755	100,00	130,00	17,00	CA	NBR	117760	wheel hub	DAF	1700 329		19034569	
117702	85,00	140,00	13/17	BS SP	FPM	111387	differential	DAF	1739 947			
109163	38,00	50,00	7,00	A	NBR	70214	crankshaft	DAF	3104 047		12010923	
109763	25,00	49,70	10,5/15	AS W	FPM	81444	gearbox	DB	000 267 0297	457290		
47429	45,00	62,00	10,00	A	NBR	18223		DB	000 997 0047			
46880	46,00	68,00	12,00	C	NBR	95185		DB	000 997 0246			
46850	65,00	90,00	10,00	A	NBR	18573		DB	000 997 0746			
47431	40,00	52,00	7,00	B	NBR	68543	gearbox	DB	000 997 0747	039918		
47432	25,00	42,90	9,50	B	NBR	47433	wheel hub	DB	000 997 1047			
46851	10,00	19,00	7,00	B	NBR	17357	fuel pump	DB	000 997 1146			
47434	32,00	45,00	7,00	A	NBR	17829	wheel hub	DB	000 997 1147	227609	12000157	

dph-no	dim 1	dim 2	dim 3	Style	Material	dph oil seal no.	Application	Type	OEM-NO	Elring	Corteco	Reinz
116562	35,00	55,00	12/16	SP	NBR	116561		DB	000 997 1346			
46852	75,00	100,00	13,00	CS	NBR	97437	wheel hub	DB	000 997 1446	105414	12011411	
46855	38,00	52,00	10,00	B	NBR	51486	gearbox	DB	000 997 1746	039780		
46856	45,00	65,00	10,00	B	NBR	51487	gearbox	DB	000 997 1846	040843		
47435	45,00	60,00	7,00	A	NBR	70213		DB	000 997 1847			
46857	45,00	58,00	7,00	A	NBR	18210		DB	000 997 2046			
47436	48,00	65,00	10,00	B	NBR	81637	gearbox	DB	000 997 2147	040991		
46845	25,00	42,00	10,00	BS	NBR	19987		DB	000 997 2245	038229		
47437	50,00	72,00	10,00	A	NBR	18335	crankshaft	DB	000 997 2247	418501	12010971	
47438	35,00	47,00	7,00	BS	NBR	22670		DB	000 997 2447			
46858	22,00	35,00	7,00	A	NBR	17557	crankshaft	DB	000 997 2546	120103	12010836	81-15377-00
47439	40,00	62,00	12/16	SP	ACM	116560	differential	DB	000 997 2647	219568		
46874	20,00	35,00	7,00	B	NBR	17514		DB	000 997 2746			
47440	20,00	35,00	7,00	B	NBR	17514		DB	000 997 2747			
82219	40,00	62,00	10,00	B	NBR	18109		DB	000 997 2847			
46875	50,00	72,00	12,00	B	NBR	18339		DB	000 997 3246			
46876	95,00	125,00	13,00	CS	NBR	82785	front axle	DB	000 997 3446	042714	12011399	
46894	68,00	90,00	13,00	BS RD	FPM	47947	differential	DB	000 997 3846	331171		
47441	68,00	90,00	13,00	BS	NBR	50809		DB	000 997 3847			
46878	26,00	37,00	7/8	AS V W	NBR	47945	steering	DB	000 997 3946	006408		81-35069-00
46879	125,00	152,40	15,00	CS	NBR	94589	rear axle	DB	000 997 4046	044687	12011406	81-35107-00
47442	45,00	60,00	10,00	C	NBR	18218		DB	000 997 4247			
82208	25,00	35,00	7,00	B	NBR	4378	gearbox	DB	000 997 4346			
47443	25,00	50,00	10,00	A	NBR	17648		DB	000 997 4347			
47967	68,00	90,00	13,00	BS RD	FPM	47947	differential	DB	000 997 4446	033171		81-35083-00
47444	28,00	52,00	10,00	A	NBR	17714	crankshaft	DB	000 997 4447		12010876	
47445	35,00	56,00	12,00	B	NBR	19521		DB	000 997 4547			
46884	8,00	16,00	7,00	A	NBR	17348	crankshaft	DB	000 997 4646		12010757	
47446	75,00	95,00	13,00	A/BS	NBR	48021	rear axle	DB	000 997 4647	562866		81-35087-00
47447	36,00	62,00	10,00	C	NBR	43231		DB	000 997 4947			
46885	75,00	95,00	10,00	A	NBR	6638	crankshaft	DB	000 997 5046	528102		
46886	42,00	65,00	12,00	AS 15 Grad	ACM	37404	differential	DB	000 997 5146	706035	19016590	
47448	75,00	95,00	13,00	CS	NBR	51719	gearbox	DB	000 997 5347			
46887	115,00	150,00	15,00	CS	NBR	46939	rear axle	DB	000 997 5446			
35697	75,00	95,00	10,00	A blue	NBR	6638	crankshaft	DB	000 997 5646	528102	12011020	

									OEM-NO			
dph-no	dim 1	dim 2	dim 3	Style	Material	dph oil seal no.	Application	Type	OEM-NO	Elring	Corteco	Reinz
47449	50,00	68,00	14,00	B	NBR	18327		DB	000 997 5647			
46888	75,00	95,00	13,00	CS	NBR	51719	gearbox	DB	000 997 6346			
34672	75,00	95,00	13,00	CS green	NBR	51719	gearbox	DB	000 997 6347	529001	12013987	81-35086-00
35021	105,00	130,00	13,00	C	NBR	18846	front axle	DB	000 997 6447	042846	12011403	81-35098-00
46889	17,00	28,00	7,00	AS	NBR	17448	crankshaft	DB	000 997 6546		12011112	
82220	45,00	62,00	12,00	C	NBR	18230		DB	000 997 6547			
46890	55,00	75,00	10,00	AS	NBR	6547	engine	DB	000 997 6646			
47450	52,00	72,00	12,00	BS WD	FPM	47951	gearbox	DB	000 997 6647	006564	01002858	
47451	95,00	125,00	13,00	CS	NBR	82785	rear axle	DB	000 997 6747			
47452	20,00	40,00	7,00	A	NBR	17524	crankshaft	DB	000 997 6947		12010826	
46891	128,00	150,00	13,00	A	NBR	25024		DB	000 997 7346			
35022	110,00	140,00	13,00	C blue	NBR	50802	rear axle	DB	000 997 7446	612103	12011404	
80376	28,00	47,00	10,00	B	NBR	19153	rear axle	DB	000 997 7547	038660	01002474	81-20307-00
46892	21,00	32,00	9,00	B SP	ACM	94769		DB	000 997 7746			
47453	35,00	56,00	12,00	B	NBR	19521		DB	000 997 7847			
47454	65,00	90,00	15,00	B RD	FPM	47957	crankshaft	DB	000 997 7947	283983		
47455	38,00	50,00	10/16	B	NBR	47971		DB	000 997 8147			
51490	19,05	31,75	6,35	A	NBR	20138		DB	000 997 8746			
47456	50,00	68,00	14,00	B	NBR	18327		DB	000 997 8847			
46893	68,00	90,00	13,00	BS RD	FPM	47947	differential	DB	000 997 8946	331171		81-35083-00
47457	35,00	52,00	10,00	B	NBR	19998		DB	000 997 8947			
48261	91,00		8,00		graph.		crankshaft	DB	000 997 9641	101577		
47458	30,00	47,00	10,00	A	NBR	17745	crankshaft	DB	000 997 9747	208302		
46895	20,00	40,00	7/8	AS	NBR	47959	crankshaft	DB	000 997 9946		12011118	
51433	145,00	175,00	13,00	A/B W blue	NBR	82427	rear axle	DB	001 997 0146			
82209	130,00	170,00	15,00	C	NBR	32120		DB	001 997 0246			
47459	140,00	165,00	12/15	AS2W WD	FPM	47979	front axle	DB	001 997 0547	043990		
47460	45,00	74,5/79,5	12/13	A SP RD	FPM/ACM	47997	crankshaft	DB	001 997 0847	309028		
47461	45,00	67,00	12/13,00	BS RD LA	FPM	36211		DB	001 997 0947	287202		
47462	45,00	67,00	12/13,00	BS RD LA	FPM	36211		DB	001 997 1047	287202		
46897	38,00	50,00	10/16	B	NBR	47971		DB	001 997 1246			
47464	60,00	85,00	12,00	B RD	FPM	47991	steering	DB	001 997 1447			
47465	60,00	85,00	10,00	B	NBR	47466		DB	001 997 1547			
47467	90,00	110,00	10,00	B	FPM	47468		DB	001 997 1647			
47469	90,00	110,00	8,00	B	NBR	47993		DB	001 997 1747			

dph-no	dim 1	dim 2	dim 3	Style	Material	dph oil seal no.	Application	Type	OEM-NO	Elring	Corteco	Reinz
46898	68,00	90,00	10,00	A	NBR	4546	crankshaft	DB	001 997 1846	251720	12011012	
46900	42,00	65,00	12,00	C	FPM	46901		DB	001 997 1946			
33282	35,00	52,00	10,00	B	NBR	19998		DB	001 997 2646			
33283	15,00	24,00	7,00	B	NBR	17404	manual gearbox	DB	001 997 2946	037133	12010790	
47470	52,00	72,00	12,00	BS WD	FPM	47951	gearbox	DB	001 997 3247	006564		
46902	36,00	58,00	10,00	B	NBR	47974	rear axle	DB	001 997 3446		01011540	
47471	125,00	152,40	15,00	CS	NBR	94589	rear axle	DB	001 997 3847	044687	12011406	81-35107-00
3908	50,00	64,00	10/13,00	B	NBR	37519	rear axle	DB	001 997 4746	411701	12011385	
47472	52,00	72,00	12,00	BS WD	FPM	47951	gearbox	DB	001 997 5047	006564		
46904	75,00	100,00	12/13,00	BS RD F	FPM	36208	crankshaft	DB	001 997 5246	525316		
46905	168,00	190,00	15,00	C LD	NBR	47975		DB	001 997 5346			
82221	19,05	30,00	7/8	AS RD blue	NBR	51224		DB	001 997 5447			
33284	24,00	37,00	7,00	A W	NBR	93746		DB	001 997 5546			
33285	18,00	28,00	7,00	A	NBR	17479	crankshaft	DB	001 997 6446		12010816	
47473	65,00	85,00	10,00	B	FPM	47474		DB	001 997 6447			
47475	65,00	85,00	10,00	B	FPM	47474		DB	001 997 6647		01019455	
46906	20,00	35,00	6,00	A	NBR	17511	crankshaft	DB	001 997 6846		12011484	
47476	65,00	85,00	10,00	B	FPM	47474		DB	001 997 6847			
46907	20,00	35,00	6,00	A	NBR	17511	crankshaft	DB	001 997 6946			
47477	40,00	55,00	10,00	B	NBR	18082	transfer gearbox	DB	001 997 7347	044318		
47478	65,00	85,00	10,00	A	NBR	18565	crankshaft	DB	001 997 7547	494402		
47479	62,00	80,00	10,00	C	NBR	51708	front axle	DB	001 997 7747	484300	12003292	
47480	42,00	58,00	7,00	BS	NBR	37347	rear axle	DB	001 997 8047	010197		
46908	70,00	90,00	10,00	AS W LD	FPM	47944	crankshaft	DB	001 997 8146	348856		
46909	7,00	16,00	7,00	A	NBR	17345		DB	001 997 8246			
46910	14,00	24,00	7,00	B	NBR	19033	gearbox	DB	001 997 8346	037109	01002369	
46911	55,00	80,00	13,00	BS	NBR	19125		DB	001 997 8446			
47481	30,00	52,00	9,00	C	NBR	95183	crankshaft	DB	001 997 8447	462829	01033894	
46912	18,00	30,00	7,00	B	NBR	19149		DB	001 997 8546			
47482	25,00	52,00	7,00	B	NBR	17653	crankshaft	DB	001 997 8547	038385	01002458	
33286	25,00	40,00	7,00	A	NBR	17614	crankshaft	DB	001 997 8746		12010850	
81585	100,00	124,00	10,5/12,5	AS W LD	MVQ	81587	crankshaft	DB	001 997 8747 FE	247189		81-22887-00
46913	60,00	80,00	13,00	B	NBR	18499		DB	001 997 9046			
46914	30,00	42,00	8,00	AS	NBR	19424		DB	001 997 9346			
46915	19,60	33,00	9,00	AS	NBR	47942		DB	001 997 9446			

dph-no	dim 1	dim 2	dim 3	Style	Material	dph oil seal no.	Application	Type	OEM-NO	Elring	Corteco	Reinz
46916	30,00	42,00	7,00	A	NBR	17728	crankshaft	DB	001 997 9746	203408		
46917	20,00	30,00	7,00	B	NBR	17506		DB	001 997 9846			
47484	70,00	90,00	10,00	A	NBR	18610		DB	002 997 0147			
113625	50,00	80,00	10/16	BS LA SP	ACM	113624		DB	002 997 0547			
47485	95,00	120,00	12,00	A	NBR	18798	crankshaft	DB	002 997 0747		12011047	
82210	42,00	62,00	10,00	C	NBR	18177		DB	002 997 0846			
47486	45,00	74,5/79,50	12/13	A SP RD	FPM/ACM	47997	crankshaft	DB	002 997 0847	309028	12010743	
46918	70,00	90,00	10,00	AS W LD	FPM	47944	gearbox	DB	002 997 1046	348856		
47487	68,00	90,00	13,00	BS RD	FPM	47947		DB	002 997 1047	331171		81-35083-00
46919	8,00	16,00	7,00	A	NBR	17348	crankshaft	DB	002 997 1246		12010757	
47488	120,00	150,00	15/12	CS	NBR	48002	front axle	DB	002 997 1847	010901		81-35103-00
46927	26,00	42,00	10,00	AS	NBR	19376	steering	DB	002 997 1946	006297		
47489	120,00	150,00	15/12	CS	NBR	48002	front axle	DB	002 997 1947	010901		
46930	34,00	52,00	8,00	A	NBR	17888	front axle	DB	002 997 2046	048364		
47490	120,00	150,00	15/12	CS	NBR	48002	front axle	DB	002 997 2047	010901		81-35103-00
47491	40,00	70,00	12/16	SP RD	ACM	48005	rear axle	DB	002 997 2147	312444		
46931	45,00	62,00	10/12	BS	NBR	15244	front axle	DB	002 997 2246			
46932	45,00	62,00	10/12	BS	NBR	15244	front axle	DB	002 997 2346			
46933	35,00	47,00	7,00	AS RD W	NBR	47976		DB	002 997 2446			
46934	40,00	55,00	8,00	B	NBR	18079	gearbox	DB	002 997 2546		12011157	
47492	25,00	35,00	7,00	AS	NBR	84590	injection pump	DB	002 997 2747	038075		
46935	30,00	50,00	10,00	A	NBR	17754	crankshaft	DB	002 997 3046		12010885	
47493	140,00	160,00	13,00	BS	NBR	70576	rear axle	DB	002 997 3247	255637	12011349	
46937	26,00	37,00	7/8	AS V W	NBR	47945	steering	DB	002 997 3846	006408	12010865	81-35069-00
47494	65,00	90,00	10,00	AS WD	NBR	48006	crankshaft	DB	002 997 3947			
33377	125,00	152,40	15,00	CS	NBR	94589	rear axle	DB	002 997 4046	044687	12011406	
47495	65,00	90,00	10,00	AS WD	NBR	48006	crankshaft	DB	002 997 4047			
47496	65,00	90,00	10,00	AS WD	NBR	48006	crankshaft	DB	002 997 4147		12011196	
3911	45,00	65,00	10,00	B	NBR	18235		DB	002 997 4246			
47497	65,00	90,00	10,00	AS WD	NBR	48006	crankshaft	DB	002 997 4247			
46938	26,00	42,00	10,00	AS	NBR	19376	steering	DB	002 997 4346	006297	01019456	
46940	19,60	33,00	8/9	AS	NBR	68850	steering	DB	002 997 4746			
46941	19,60	33,00	9,00	AS	NBR	47942	water pump	DB	002 997 4846	054003		
46942	45,00	62/68,00	10/8	AS BD	NBR	47953		DB	002 997 5046			
46944	75,00	95,00	10,00	A/B WD	FPM	47938		DB	002 997 5646			

dph-no	dim 1	dim 2	dim 3	Style	Material	dph oil seal no.	Application	Type	OEM-NO	Elring	Corteco	Reinz
47499	100,00	120,00	10,00	A W LD	FPM	48007	transmission	DB	002 997 5947			
46946	30,00	40,00	7,00	AS	NBR	17725		DB	002 997 6146	038806		
46947	45,00	65,00	10,00	B	NBR	18235		DB	002 997 6246			
46948	25,00	37,00	7,00	A	NBR	17609	crankshaft	DB	002 997 6346	137006		
46949	110,30	133,30	12	C	NBR	46950	front axle	DB	002 997 6446	210382	01019319	
47500	70,00	81,50	6,00	AW V	NBR	48009	front axle	DB	002 997 6547	331163	20016779	
47501	52,00	70,00	10,00	B	FPM	47502		DB	002 997 6647			
37515	45,00	65,00	10,00	AW/B WD	ACM	37514	rear axle	DB	002 997 6747			
46951	90,00	112,70	13,00	C	NBR	50803	rear axle	DB	002 997 6846	044571	12011397	81-33850-00
46952	19,60	33,00	8/9	AS	NBR	68850	steering	DB	002 997 7046			
47503	72,00	84/85,5	18,00	BS	NBR	48057	rear axle	DB	002 997 7047			
46859	30,00	42,00	8,00	AS	NBR	19424		DB	002 997 7146			
47504	60,00	80,00	8,00	A	NBR	18489	crankshaft	DB	002 997 7147	029335		
37131	30,00	42,00	8,00	AS	NBR	19424	crankshaft	DB	002 997 7246		01019320	
47505	50,00	68,00	8,00	A	NBR	18322		DB	002 997 7247			
46860	25,00	40,00	8,00	AS DUO	NBR	80977	gearbox	DB	002 997 7446	038164		
46861	75,00	95,00	10,00	A/B WD	FPM	47938	differential	DB	002 997 7546	006394		
82211	60,00	85,00	10,00	B	NBR	47466	differential	DB	002 997 7646	041599	12011334	
46864	54,80	70,00	9/9,60	AS	NBR	47963		DB	002 997 7746	237760		
95044	45,00	52,00	3,00	BO	NBR	95043		DB	002 997 8147		01029642	
46865	45,00	62,00	10/12	BS	NBR	15244	front axle	DB	002 997 8246			
46866	17,00	35,00	7,00	A	NBR	93613	water pump	DB	002 997 8446	054003	12010810	81-17193-00
47506	75,00	100,00	12,00	B	NBR	18667	wheel hub	DB	002 997 8447	531006		81-35294-00
47507	75,00	100,00	12,00	B	NBR	18667	wheel hub	DB	002 997 8547	531006		
46867	70,00	90,00	8,00	B	NBR	46868		DB	002 997 8646			
47508	70,00	81,50	6,00	AW V	NBR	48009	front axle	DB	002 997 8847	331163	20016779	
46871	18,00	30,00	7,00	B	NBR	19149		DB	002 997 9446			
47509	22,00	32,00	7/8	AS	NBR	48039	crankshaft	DB	002 997 9547		12000459	
116162	30,00	40,00	7/10	BABSL	NBR	6440		DB	003 997 0040	201200		
47510	45,00	67,00	12/13	A/BS RD W	ACM	50166	crankshaft	DB	003 997 0347			
4542	42,00	58,00	7,00	BS	NBR	37347	rear axle	DB	003 997 0547	010197	01017010	
47511	42,00	55,00	9,00	B	FPM	48010	front axle	DB	003 997 0647			
46872	48,00	80,00	12/18	BS2	NBR	47964		DB	003 997 0746	109916		
47512	105,00	130,00	12,00	AW/BS RD vlies	FPM	112532	crankshaft	DB	003 997 0747	524972	12014447	
46873	8,00	16,00	7,00	A	NBR	17348	crankshaft	DB	003 997 1046			

dph-no	dim 1	dim 2	dim 3	Style	Material	dph oil seal no.	Application	Type	OEM-NO	Elring	Corteco	Reinz
47513	40,00	70,00	12/16	SP RD	ACM	48005	rear axle	DB	003 997 1147	312444		81-35073-00
94659	45,00	65,00	10,00	AW/B WD	ACM	37514	rear axle	DB	003 997 1247			
46953	28,00	40,00	7,00	AS	NBR	93614	crankshaft	DB	003 997 1346		12010874	
47515	105,00	130,00	12,00	AW/BS RD vlies	FPM	112532	crankshaft	DB	003 997 1347	052492		
46954	52,00	72,00	12,00	C	NBR	18376	wheel hub	DB	003 997 1446		01003238	
46955	42,00	60,00	10,00	A	NBR	18168	crankshaft	DB	003 997 1646	040320	12010944	
47516	110,30	133,30	12/10	C	NBR	68848	front axle	DB	003 997 2247	210382	01019319	
47517	118,00	140,00	13,00	B	NBR	47041	wheel hub	DB	003 997 2347		20016791	
35020	50,00	65,00	10,00	C	NBR	18319	wheel hub	DB	003 997 2546		01003218	
47518	28,00	40,00	8/8,50	AS	NBR	48011	crankshaft	DB	003 997 2647	237744		
46956	20,00	30,00	5,00	B V	NBR	47943		DB	003 997 2846			
46957	75,00	95,00	10,00	A	NBR	6638	crankshaft	DB	003 997 3046	528102		
4645	55,00	75,00	10,00	AS blue	NBR	6547	engine	DB	003 997 3047			
46958	85,00	110,00	13,00	A	NBR	19167		DB	003 997 3146			
46959	70,00	90,00	10,00	AS W LD	FPM	47944		DB	003 997 3346	348856		
47519	65,00	85,00	10,00	A	NBR	18565	crankshaft	DB	003 997 3347	494402	12011007	
46960	70,00	90,00	10,00	AS W LD	FPM	47944	crankshaft	DB	003 997 3446			
47520	70,00	90,00	10,00	AS	NBR	18611	crankshaft	DB	003 997 3447		12011015	
46961	42,00	65,00	12,00	C	FPM	46901		DB	003 997 3546			
46962	75,00	95,00	10,00	A/B WD	FPM	47938		DB	003 997 3846	006394		
46963	26,00	37,00	7/8	AS V W	NBR	47945	steering	DB	003 997 3946	006408		
4502	26,00	45,00	10,00	B blue	NBR	4442	injection	DB	003 997 4046	038490	12011330	81-20308-00
47521	95,00	130,00	13,00	C	NBR	18810	front axle	DB	003 997 4047	042714	12011399	
46964	68,00	90,00	13,00	BS RD	FPM	47947		DB	003 997 4446	331171	12012074	81-35083-00
46965	105,00	130,00	13,00	C	NBR	18846	front axle	DB	003 997 4546		12011403	
47522	75,00	100,00	12/13,00	BS RD F	FPM	36208	crankshaft	DB	003 997 4547	525316		
47523	75,00	100,00	13,00	B	NBR	20038		DB	003 997 4647			
81849	38,00	62,00	10,00	C	NBR	18052		DB	003 997 4746			
46966	165,00	190,00	13,00	BS	NBR	47254	rear axle	DB	003 997 4846	346640		
46969	42,00	56,00	7,00	AS W	NBR	94735	water pump	DB	003 997 5146	344400	12010943	81-51109-00
46970	30,00	42,00	8,00	AS	NBR	19424		DB	003 997 5346			
82222	45,00	85,30	9,5/14,00	A W WD	ACM	6343	differential	DB	003 997 5347			
47524	62,00	80,00	10,00	B	NBR	18528	crankshaft	DB	003 997 5947	028436		
47525	25,00	40,00	8,00	B	NBR	19151		DB	003 997 6047			
47526	48,00	62,00	10,00	B	NBR	97434		DB	003 997 6147			

dph-no	dim 1	dim 2	dim 3	Style	Material	dph oil seal no.	Application	Type	OEM-NO	Elring	Corteco	Reinz
95768	40,00	56,00	10/12	BABSL blue	NBR	95767		DB	003 997 6646			
47527	145,00	175,00	14,00	BS	NBR	4376	rear axle	DB	003 997 6647	208210	12011374	
46971	125,00	160,00	18,00	BS LD F	FPM	36207	crankshaft	DB	003 997 6746	316385		
94988	90,00	112,70	13,00	C	NBR	50803	rear axle	DB	003 997 6846		12011397	
47528	70,00	90,00	10,00	AS	NBR	18611	crankshaft	DB	003 997 6847		12011015	
47529	65,00	85,00	10,00	A	NBR	18565	crankshaft	DB	003 997 6947	494402	12011007	
46972	50,00	72,00	8/10	AS V	NBR	47950	steering	DB	003 997 7246	006432		
47530	44,00	60,00	8,00	B RD LA	MVQ	15241	gearbox	DB	003 997 7247	319104		
47531	44,00	60,00	8,00	B RD LA	MVQ	15241	gearbox	DB	003 997 7347	319104		
46973	22,00	30,00	7,00	B	NBR	19269		DB	003 997 7446			
46974	52,00	72,00	12,00	BS WD	FPM	47951	gearbox	DB	003 997 7546	006564	01016879	
46975	30,00	50,00	10,00	B	NBR	17755		DB	003 997 7746			
114518	10,00	16,00	6,00	B	NBR	37534	gearbox	DB	003 997 7946			
46976	68,00	90,00	10,00	A	NBR	4546	crankshaft	DB	003 997 8046			
47532	20,00	42,00	7,00	AS WD	NBR	48013	steering	DB	003 997 8147	277290	12012842	
15260	45,00	85,30	9,5/14,00	A W WD	ACM	6343	differential	DB	003 997 8347	467995	01019449	
46977	30,00	42,00	7,00	B	NBR	17729		DB	003 997 8546	038865		
47533	32,00	45,00	7,00	A	NBR	17829	wheel hub	DB	003 997 8647	227609		
47534	12,00	20,00	5,00	B	NBR	19072		DB	003 997 8747			
46978	32,00	45,00	7,00	A	NBR	17829	wheel hub	DB	003 997 8946	227609		
82223	55,00	72,00	10,00	BS	NBR	45537		DB	003 997 9147			
3912	45,00	62,00	10/12	BS	NBR	15244	front axle	DB	003 997 9346		01019288	
46979	20,00	30,00	5,00	B V	NBR	47943		DB	003 997 9646			
46980	10,00	15,00	3,00	B OF	NBR	47952	front axle	DB	003 997 9846	010804	01002259	81-25545-00
93265	26,00	37,00	7,00	A	NBR	17672	crankshaft	DB	003 997 9946		12010865	
48065	14,00	24,00	7,00	B	NBR	19033		DB	003760 014200	037109		
47535	90,00	110,00	10,00	B	FPM	47468		DB	004 997 0047			
46981	45,00	62/68,00	10/8	AS BD	NBR	47953	wheel hub	DB	004 997 0146	044369		81-35288-00
46982	45,00	62/68,00	10/8	AS BD	NBR	47953	wheel hub	DB	004 997 0446	044369		81-35288-00
15265	44,00	60,00	8,00	B RD LA green	MVQ	15241	gearbox	DB	004 997 0547	319104		
46983	85,00	105,00	10,00	B	NBR	50341	gearbox	DB	004 997 0646	556807	12011340	81-25546-00
47536	85,00	105,00	10,00	B LD	FPM	4047	gearbox	DB	004 997 0647	033464	12013757	
46984	85,00	105,00	12,00	B	NBR	44329		DB	004 997 0746		12011359	
47537	48,00	75,00	8,00	B RD	FPM	4545	gearbox	DB	004 997 0747	033472	12011307	
46985	55,00	75,00	8,00	B RD	FPM	36792	gearbox	DB	004 997 0846			

dph-no	dim 1	dim 2	dim 3	Style	Material	dph oil seal no.	Application	Type	OEM-NO	Elring	Corteco	Reinz
46986	55,00	75,00	10/8	B	NBR	50345	gearbox	DB	004 997 0946	041335	12011333	81-20991-20
82212	65,00	90,00	13,00	BS	NBR	48401	differential	DB	004 997 1046			
47538	105,00	130,00	12,00	A/BS LD	FPM	48035	crankshaft	DB	004 997 1047		12014447	
46987	65,00	80,00	8/5,20	B	FPM	47954		DB	004 997 1246	493902		
37381	19,05	33,33	7,93	AS	NBR	95982	steering	DB	004 997 1247	278556		
47539	75,00	100,00	10,00	A	NBR	84535	gearbox	DB	004 997 1347	530107	12011021	
46988	19,60	33,00	8/9	AS	NBR	68850	steering	DB	004 997 1546	006300		
47540	45,00	67,00	8,00	AS W RD	FPM	36206	crankshaft	DB	004 997 1547		12015258	
21628	25,00	37,00	7,00	A	NBR	17609	crankshaft	DB	004 997 1646	137006	12010848	
47541	120,00	150,00	15/12	CS	NBR	48002	front axle	DB	004 997 1747	010901	12011418	81-35103-00
47542	120,00	150,00	15/12	CS	NBR	48002	front axle	DB	004 997 1847	010901	12011418	81-35103-00
47543	80,00	100,00	10,00	AS	NBR	18682		DB	004 997 2047	108499		
46989	85,00	105,00	10,00	B LD	FPM	4047	gearbox	DB	004 997 2246	033464	12013757	
46990	40,00	62,00	12/16	SP	ACM	116560	differential	DB	004 997 2546	219568		
46991	33,00	50,00	8,00	B	NBR	97159		DB	004 997 2846			
46992	45,00	62,00	7,00	B V	NBR	47956		DB	004 997 2946			
46993	30,00	47,00	8,00	B	NBR	36748	gearbox	DB	004 997 3246	038873		
46994	48,00	65,00	10,00	AS	NBR	19664	crankshaft	DB	004 997 3346			
47544	75,00	100,00	12/13,00	BS RD F	FPM	36208	crankshaft	DB	004 997 3947	525316	12011674	
47545	40,00	55,00	8,00	AS LD	ACM	47984		DB	004 997 4047			
46995	40,00	62,00	12/16	SP	ACM	116560	differential	DB	004 997 4146	219568		
82213	32,00	47,00	7,00	B	NBR	17833		DB	004 997 4346			
96317	75,00	100,00	13,00	B	NBR	20038		DB	004 997 4547			
47546	40,00	70,00	12/16	BS RD	FPM	48015	differential	DB	004 997 4747		12015258	
47547	40,00	55,00	8,00	AS LD	ACM	47984		DB	004 997 4847			
82809	17,00	28,00	7,00	B	NBR	37867	injection pump	DB	004 997 4947		01002391	
47548	40,00	55,00	8,00	AS LD	ACM	47984		DB	004 997 5347			
114519	10,00	16,00	6,00	B	NBR	37534	gearbox	DB	004 997 5546			
46996	40,00	62,00	12/16	SP	ACM	116560	differential	DB	004 997 5646	219568		
96503	56,00	70,00	9/6	AS SP	NBR	80858	steering	DB	004 997 5847			
47549	140,00	165,00	12/15	AS2W WD	FPM	47979	front axle	DB	004 997 5947	043990		
46997	75,00	100,00	12/13,00	BS RD	FPM	36208	crankshaft	DB	004 997 6046	525316	12011674	
46998	30,00	40,00	7,00	AS	NBR	17725	crankshaft	DB	004 997 6246	038806	12011131	
47550	25,00	40,00	7,00	A	NBR	17614	crankshaft	DB	004 997 6247		12010850	
47551	25,00	35,00	7,00	AS	NBR	84590	injection pump	DB	004 997 6347			

dph-no	dim 1	dim 2	dim 3	Style	Material	dph oil seal no.	Application	Type	OEM-NO	Elring	Corteco	Reinz
46999	28,00	40,00	7,00	B	NBR	33354		DB	004 997 6446			
96854	55,00	80,00	10,00	BS	NBR	50343	gearbox	DB	004 997 6646	446602		
47552	45,00	67,00	12/13	A/BS RD W	ACM	50166	crankshaft	DB	004 997 6647	287202		
15264	45,00	74,50	12/14,50	AS W RD	ACM	15238	crankshaft	DB	004 997 6846	284742		
95340	55,00	75,00	8,00	B RD	FPM	36792	gearbox	DB	004 997 6946		12011308	
47553	100,00	120,00	10,00	A W LD	FPM	48007	transmission	DB	004 997 7047			
47001	20,00	30,00	7,00	A	NBR	17504	transfer gearbox	DB	004 997 7146	102300		
47554	55,00	75,00	8,00	BS	NBR	47555		DB	004 997 7147			
47556	40,00	70,00	12/16	BS RD	FPM	48015		DB	004 997 7247		01019450	
47002	65,00	90,00	13,00	AW/BS RD vlies	FPM	84257	crankshaft	DB	004 997 7346	283983		
47003	115,00	150,00	13,00	C	NBR	18892		DB	004 997 7446			
47557	30,00	47,00	8,00	B	NBR	36748	gearbox	DB	004 997 7547	038873		
47558	40,00	55,00	10,00	B	NBR	18082	transfer gearbox	DB	004 997 7647			
46846	115,00	150,00	13,00	C	NBR	18892	rear axle	DB	004 997 7745	044660	12003475	
47005	45,00	62/68,00	10/8	AS BD	NBR	47953	wheel hub	DB	004 997 8146	044369		
47006	16,00	26,00	7,00	A V	NBR	47958		DB	004 997 8346			
47007	17,00	28,00	7,00	A	NBR	17447	crankshaft	DB	004 997 8546	050300	01210807	
47559	55,00	75,00	9/11	AS	NBR	47977		DB	004 997 9247	522287		
36216	125,00	160,00	18,00	BS LD F	FPM	36207	crankshaft	DB	004 997 9347	316385	12012432	81-21040-10
47008	80,00	100,00	10,00	A	FPM	20638	crankshaft	DB	004 997 9546			
4049	80,00	100,00	10,00	A green	NBR	4306	front-/rear axle	DB	004 997 9646	546038	12011026	
47009	20,00	40,00	7/8	AS	NBR	47959	crankshaft	DB	004 997 9946		12011118	
47560	42,00	56,00	7,00	AS	NBR	94735	water pump	DB	005 997 0047	344400	12010943	
47561	17,00	35,00	7,00	A	NBR	93613	water pump	DB	005 997 0147	054003	12010810	
47562	55,00	75,00	8,00	BS	NBR	47555		DB	005 997 0247			
47010	120,00	145,00	15/12	C	NBR	50805	rear axle	DB	005 997 0346	044679		81-35106-00
82282	70,00	100,00	12,00	A	NBR	84533	engine various	DB	005 997 0846			
47011	55,00	80,00	10/12	AS	NBR	80530	crankshaft	DB	005 997 0946	048437	12010986	
47563	75,00	95,00	10/9,50	B WD	FPM	4380	transfer gearbox	DB	005 997 0947	327263	01019459	
47012	80,00	100,00	10,00	A green	NBR	4306	front-/rear axle	DB	005 997 1046	546038	12011026	
47564	75,00	95,00	12,50	BS	NBR	50347	camshaft	DB	005 997 1047	008370		
47013	40,00	62,00	10,00	A	NBR	18107	automatic gearbox	DB	005 997 1146	330809	12010936	
47565	75,00	95,00	10/9,50	B WD	FPM	4380	transfer gearbox	DB	005 997 1147	327263		
47014	40,00	70,00	12/16	SP RD	ACM	48005	rear axle	DB	005 997 1246	312444		81-35073-00
47566	75,00	95,00	12,50	BS	NBR	50347	camshaft	DB	005 997 1247	008370		

dph-no	dim 1	dim 2	dim 3	Style	Material	dph oil seal no.	Application	Type	OEM-NO	Elring	Corteco	Reinz
4074	72,00	85,60	18,00	B blue	NBR	70313	front axle	DB	005 997 1646	009360	16011841	
47567	75,00	95,00	12,50	BS	NBR	50347	camshaft	DB	005 997 1847	008370		
47568	75,00	95,00	10/9,50	B WD	FPM	4380	transfer gearbox	DB	005 997 1947	327263		
3913	40,00	55,00	10,00	B	NBR	18082	transfer gearbox	DB	005 997 2046	044318		
47016	72,00	84/85,6	18,00	BS	NBR	48057	rear axle	DB	005 997 2346			
48038	72,00	84/85,6	18,00	BS	NBR	48057	rear axle	DB	005 997 2446			
47569	55,00	75,00	8,00	BS	NBR	47555		DB	005 997 2547			
48907	120,00	140,00	13,00	AW/BS LD	FPM	112531	crankshaft	DB	005 997 2647		12014877	
110389	120,00	140,00	13,00	A SP LD	FPM/ACM	110389	crankshaft	DB	005 997 2647			
47018	22,00	32,00	7/8	AS	NBR	48039	gearbox	DB	005 997 3546	075175		
115695	30,00	40,00	7/10	BABSL	NBR	6440		DB	005 997 3547		01026333	
47571	26,00	37,00	7/8	AS V W	NBR	47945	steering	DB	005 997 3747	006408	12014826	81-35069-00
47019	45,00	74,5/79,5	12/13	A SP RD	FPM/ACM	47997	crankshaft	DB	005 997 3846	309028		81-17328-20
47020	40,00	62,00	12/16	SP	ACM	116560	differential	DB	005 997 4146	219568		
47021	50,80	65,00	9/9,50	AS	NBR	48040	steering	DB	005 997 4246	237752		
47572	14,00	24,00	7,00	B	NBR	19033		DB	005 997 4247	037109		
47022	125,00	150,00	15,00	C	NBR	50804	rear axle	DB	005 997 4446		01003494	
47573	50,00	67,50	13,5/8	SP	NBR	48017	engine	DB	005 997 4447	464872	01019452	81-35079-00
47574	140,00	165,00	12/15	AS2W WD	FPM	47979	front axle	DB	005 997 4547	043990		
47023	25,00	40,00	8,00	AS DUO	NBR	80977	gearbox	DB	005 997 4846	038164		
37349	45,00	62/68,00	10/12,00	AS BS	NBR	37348	front axle	DB	005 997 5046			
47025	105,00	130,00	12,00	AW/BS RD vlies	FPM	112532	crankshaft	DB	005 997 5146	524972		
47575	35,00	52,00	10,00	A	NBR	17934	crankshaft	DB	005 997 5147	258407		
47026	54,80	70,00	9/9,60	AS	NBR	47963		DB	005 997 5546	237760		
47027	80,00	100,00	13,00	C RD	MVQ	48041	gearbox	DB	005 997 5746			
47028	20,00	32,00	7,00	BABSL	NBR	51422	steering	DB	005 997 5846	037524	12010824	
47576	35,00	47,00	7,00	A	NBR	17906	crankshaft	DB	005 997 5847	251402	12010904	
84565	30,00	42,00	7,00	A	NBR	17728	crankshaft	DB	005 997 5946		12010880	
47577	30,00	47,00	8,00	B	NBR	36748	gearbox	DB	005 997 6047	038873		
82214	32,00	45,00	7,00	A	FPM	20553		DB	005 997 6146			
82215	18,00	30,00	7/8	AS	NBR	4536	crankshaft	DB	005 997 6346			
47578	68,00	85,00	13,00	BS	NBR	95187	rear axle	DB	005 997 6647	562831	01027962	
47580	68,00	85,00	10,00	B RD	FPM	48018	rear axle	DB	005 997 6747		01016878	
47581	68,00	85,00	13,00	BS	NBR	95187		DB	005 997 6847	562831		
47029	33,00	50,00	8,00	B	NBR	97159		DB	005 997 6946			81-33857-00

dph-no	dim 1	dim 2	dim 3	Style	Material	dph oil seal no.	Application	Type	OEM-NO	Elring	Corteco	Reinz
47582	68,00	85,00	10,00	B RD	FPM	48018	rear axle	DB	005 997 6947			
47030	53,98	76,20	12,5/8	C	NBR	48042	wheel hub	DB	005 997 7046		01003247	
47031	59,00	72,00	12/12,50	AW/BS	NBR	15259	transmission shaft	DB	005 997 7146	467871	12012242	81-35081-00
47032	42,00	55,00	9,00	B	FPM	48010	front axle	DB	005 997 7446			
114677	50,00	67,50	13,5/8	SP	NBR	48017	engine	DB	005 997 7447		01019452	
47583	68,00	85,00	10,00	B RD	FPM	48018	rear axle	DB	005 997 7647			
47033	20,00	28,00	6,00	A	NBR	19212	crankshaft	DB	005 997 7746		12001989	
47584	68,00	85,00	13,00	BS	NBR	95187		DB	005 997 7747	562831		
37518	59,00	72,00	12/12,50	AW/BS	NBR	15259	transmission shaft	DB	005 997 7846		12012242	
48359	17,00	28,00	6,00	DFD	NBR	4491		DB	005 997 8047			
47585	75,00	100,00	12/13,00	BS RD F	FPM	36208	crankshaft	DB	005 997 8247	525316	12011674	
47586	100,00	124,00	13,00	BS LA LD	FPM	48019	crankshaft	DB	005 997 8347			
4615	170,00	190,00	8,50	AS K	NBR	4045	rear axle	DB	005 997 8447	327247	12012576	
47034	50,00	72,00	10,00	A	NBR	18335	crankshaft	DB	005 997 8546	418501	12010971	
82224	32,00	50,00	12,00	C	NBR	17846		DB	005 997 8547			
47587	30,00	47,00	8,00	B	NBR	36748	gearbox	DB	005 997 8647	038873	01002484	
36121	40,00	55,00	10,00	B	NBR	18082	transfer gearbox	DB	005 997 8747	044318	01002552	
47588	45,00	74,5/79,5	12/13	A SP RD	FPM/ACM	47997	crankshaft	DB	005 997 9047	312010	12010743	
47035	80,00	100,00	12,00	B	FPM	47315		DB	005 997 9646	042420		
47037	80,00	100,00	10,00	B	NBR	18683	gearbox	DB	005 997 9746	042390		
94633	17,00	28,00	7,00	B	NBR	37867		DB	005 997 9747			
82550	12,00	18,00	6,00	B	NBR	113655	gearbox automatic	DB	006 997 0147			
3910	19,05	33,33	7,93	AS blue	NBR	95982	steering	DB	006 997 0247	278556	01020304	
34671	90,00	120,00	13,00	C green	NBR	51722	rear axle	DB	006 997 0446	042617	12011413	81-35149-00
47038	120,00	145,00	15,00	C	NBR	43207	rear axle	DB	006 997 0546	044679	12011405	81-35106-00
50805	120,00	145,00	15/12	C	NBR	50805	rear axle	DB	006 997 0546			
96504	75,00	100,00	9,5/12,5	AS WD SF	NBR	97147	crankshaft	DB	006 997 0547		01031732	
47590	55,00	75,00	9/11	AS	NBR	47977	crankshaft	DB	006 997 0747			
93755	55,00	72,00	10,00	C	NBR	18418	differential	DB	006 997 1246		01001557	
47591	45,00	67,00	12/13,00	BS RD LA	FPM	36211	crankshaft	DB	006 997 1247	305529	12011247	81-21023-30
47040	118,00	140,00	13,00	B	NBR	47041	front axle	DB	006 997 1346			
47592	105,00	130,00	12,00	AW/BS RD vlies	FPM	112532	crankshaft	DB	006 997 1647	524972		
47593	125,00	150,00	15,00	C	NBR	50804	rear axle	DB	006 997 2147		01003494	
47594	105,00	130,00	12,00	AW/BS RD vlies	FPM	112532	crankshaft	DB	006 997 2347	524972	12014447	
47049	62,00	80,00	10,00	C	NBR	51708	front axle	DB	006 997 2646	484300	12003292	

dph-no	dim 1	dim 2	dim 3	Style	Material	dph oil seal no.	Application	Type	OEM-NO	Elring	Corteco	Reinz
47595	140,00	165,00	12/15	AS2W WD	FPM	47979	front axle	DB	006 997 3147	043990		
47099	34,00	52,00	8,00	A	ACM	48043		DB	006 997 3246			
47596	120,00	140,00	13,00	AW/BS LD	FPM	112531	crankshaft	DB	006 997 3347	090158	12014877	
115627	135,00	171,37	15,00	C SP	FPM	115626		DB	006 997 4046			
47597	85,00	105,00	10,00	B LD	FPM	4047	gearbox	DB	006 997 4147	033464		
47240	25,00	35,00	7,00	B	NBR	4378	gearbox	DB	006 997 4946	038083	12014616	
47598	30,00	40,00	7,00	AS RD W	FPM	47982	camshaft	DB	006 997 5347	598993	12014403	
35019	65,00	90,00	15,00	B RD	FPM	47957	crankshaft	DB	006 997 5446	283983	12014380	
70578	10,00	16,00	6,00	B	NBR	37534	gearbox	DB	006 997 6146			
47599	29,90	47,00	8,00	AW RD	FPM	47983	steering	DB	006 997 6147			
82508	45,00	85,30	9,5/18,5	A W WD	ACM	82404		DB	006 997 6747		01019454	
47601	40,00	55,00	8,00	AS LD	ACM	47984		DB	006 997 6847			
47241	95,00	120,00	13,00	C	NBR	51723	rear axle	DB	006 997 6946	042684	12011398	81-35093-00
4048	85,00	105,00	10,00	B LD	FPM	4047	gearbox	DB	006 997 7046	033464		
22998	51,00	58,00	4,00	BO	NBR	22996	stub axle	DB	006 997 7147	222940		
68575	30,00	47,00	8,00	A RD	NBR	61495		DB	006 997 7247			
47602	20,00	35,00	7,00	A	NBR	17512	crankshaft	DB	006 997 7447	106208	12010825	
47603	30,00	42,00	7,00	A	NBR	17728	crankshaft	DB	006 997 7647	203408	12010880	
47242	45,00	74,5/79,5	12/13	A SP RD	FPM/ACM	47997	crankshaft	DB	006 997 8046	309028		
47243	21,00	33,00	8/9,50	AS V	NBR	36731	steering	DB	006 997 8146	007544		
47244	32,00	44,00	8/9,50	AS	NBR	36730	steering	DB	006 997 8246	007552		
47245	100,00	125,00	13/10	C	NBR	50810	rear axle	DB	006 997 8346			
47604	65,00	90,00	15,00	B RD	FPM	47957	crankshaft	DB	006 997 8547	283983		
47605	85,00	105,00	10,00	B LD	FPM	4047	gearbox	DB	006 997 8647	033464		
47606	48,00	75,00	8,00	B RD	FPM	4545	gearbox	DB	006 997 8747	033472		
47246	45,00	74,50	12/14,50	A SP RD	FPM/ACM	47997	crankshaft	DB	006 997 8846			
47607	85,00	105,00	12,00	B	NBR	44329	gearbox	DB	006 997 8847	033480		
34017	50,00	70,00	8,00	C blue	NBR	61496	front axle	DB	006 997 9046	108642		
47608	19,05	33,33	7,93	AS	NBR	95982	steering	DB	006 997 9247	278556		
47247	100,00	125,00	13,00	C	NBR	18829	rear axle	DB	006 997 9346		12011401	81-35096-00
15268	50,00	70,00	10/14	BS2 blue	NBR	59295	front axle	DB	006 997 9646	008028	01016768	81-35292-00
82225	70,00	110,00	13,00	C	NBR	18638		DB	006 997 9647			
81766	100,00	123,80	13,00	C	NBR	80662		DB	006 997 9846			
47836	58,00	72,00	8,00	A W	NBR	113615	crankshaft	DB	00650 405 8200		12010993	
47249	44,00	60,00	8,00	B RD LA	MVQ	15241	gearbox	DB	007 997 0246	319104		

dph-no	dim 1	dim 2	dim 3	Style	Material	dph oil seal no.	Application	Type	OEM-NO	Elring	Corteco	Reinz
115591	58,00	80,00	10/8	AW/BS blue	NBR	115590	differential	DB	007 997 0347			
47251	135,00	165,00	14/10	BS	NBR	50340	rear axle	DB	007 997 0446			
47609	40,00	70,00	13,00	special	FPM	47986		DB	007 997 0947		12015262	
47610	40,00	70,00	7/8	B	FPM	47987	differential	DB	007 997 1047			
47611	29,90	47,00	8,00	AW RD	FPM	47983	steering	DB	007 997 1547			
47612	29,90	47,00	8,00	AW RD	FPM	47983	steering	DB	007 997 1647			
47613	29,90	47,00	8,00	AW RD	FPM	47983	steering	DB	007 997 1747			
47252	165,00	190,00	13,00	BS	NBR	47254	rear axle	DB	007 997 1846			
47614	48,00	69,00	10,00	B RD	FPM	47988	gearbox	DB	007 997 2047		12011306	81-35078-00
47615	48,00	65,00	10,00	B	NBR	81637	gearbox	DB	007 997 2147	040991	12011331	
36793	55,00	75,00	8,00	B RD	FPM	36792	gearbox	DB	007 997 2247	284645	12011308	
61442	55,00	75,00	10/8	B	NBR	50345	gearbox	DB	007 997 2347			81-20991-20
47256	120,00	140,00	13,00	AW/BS LD	FPM	112531	crankshaft	DB	007 997 2446	090158	12014877	
47257	120,00	145,00	15/12	AW BS WD	FPM	95129		DB	007 997 2546			
50805	120,00	145,00	15/12	C	NBR	50805	rear axle	DB	007 997 2546			
47259	30,00	40,00	7,00	B	NBR	17726		DB	007 997 3446			
3909	59,00	72,00	12/12,50	AW/BS	NBR	15259	transmission shaft	DB	007 997 3547	467871	12012242	81-35081-00
47260	100,00	120,00	13,00	C	NBR	18825	front axle	DB	007 997 3646	592609	12011400	81-35097-00
47261	17,00	28,00	8,00	B DUO	NBR	20245		DB	007 997 3846			
47616	80,00	100,00	12,00	B	FPM	47315		DB	007 997 3847	042420		
47617	68,00	90,00	10/9,50	B WD	FPM	47989	rear axle	DB	007 997 3947			
114377	68,00	90,00	10,00	A/B WD	FPM	114377	rear axle	DB	007 997 3947			
47262	34,00	52,00	8,00	A	ACM	48043		DB	007 997 4046			
69187	14,00	24,00	7,00	AS	NBR	43079		DB	007 997 4146			
6549	75,00	95,00	10/9,50	B WD	FPM	4380	transfer gearbox	DB	007 997 4747			
47264	12,00	22,00	7,00	B	NBR	17372		DB	007 997 4946			
47618	80,00	100,00	12,00	B	FPM	47315		DB	007 997 4947	042420		
61262	14,00	26,00	7,00	B	NBR	61494		DB	007 997 5046			
47619	68,00	90,00	10/9,50	B WD	FPM	47989	rear axle	DB	007 997 5047			
47620	75,00	95,00	10/9,50	B WD	FPM	4380	transfer gearbox	DB	007 997 5147			
4441	48,00	75,00	8,00	B RD brown	FPM	4545	gearbox	DB	007 997 5447	033472	12011307	
47622	60,00	85,00	10,00	B	NBR	47466	gearbox	DB	007 997 5547		12011334	
47623	60,00	85,00	12,00	B RD	FPM	47991	gearbox	DB	007 997 5647		12012578	81-21108-20
47624	90,00	110,00	8,00	B	NBR	47993		DB	007 997 5747			
47625	90,00	110,00	10,00	BS	MVQ	81539		DB	007 997 5847			

dph-no	dim 1	dim 2	dim 3	Style	Material	dph oil seal no.	Application	Type	OEM-NO	Elring	Corteco	Reinz
36791	85,00	105,00	10,00	B LD	FPM	4047	gearbox	DB	007 997 5947	033464	12013757	
47626	70,00	90,00	10,00	AS W LD	FPM	47944	gearbox	DB	007 997 6047	348856	12015772	
47627	40,00	70,00	13,00	SP	FPM	47986		DB	007 997 6347		12015262	
47265	42,00	65,00	10,00	A	NBR	18181		DB	007 997 6446			
47628	40,00	70,00	13,00	SP	FPM	47986		DB	007 997 6547		12015262	
47629	40,00	70,00	7/8	B	FPM	47987	differential	DB	007 997 6647			
47630	40,00	70,00	7/8	B	FPM	47987	differential	DB	007 997 6747		12015261	
47266	40,00	58,00	9,00	AS	NBR	43814		DB	007 997 7146			
47267	9,00	16,00	9/15	B	NBR	48047		DB	007 997 7346			
82216	36,00	54,00	7,00	B	NBR	50806		DB	007 997 7446			
47263	40,00	62,00	7,00	A	NBR	18104		DB	007 997 7646			
47631	38,00	55,00	7,00	A	NBR	19536	transfer gearbox	DB	007 997 7847		12010926	
47268	65,00	80,00	8/5,20	B	FPM	47954	crankshaft	DB	007 997 7946	493902	20020508	
47269	68,00	90,00	10/9,50	B WD	FPM	47989	rear axle	DB	007 997 8046	008508		
47270	68,00	90,00	10,00	BS	NBR	95922	wheel hub	DB	007 997 8146		01026650	
47272	165,00	190,00	13,00	BS	NBR	47254	rear axle	DB	007 997 8246	346640	01002772	
80020	38,00	55,00	7,00	A	FPM	41958	transfer gearbox	DB	007 997 8247		12010926	
47273	80,00	100,00	10,00	A green	NBR	4306	front-/rear axle	DB	007 997 8346		12011026	
47632	48,00	62,00	8,00	A	ACM	47994		DB	007 997 8347			
47274	80,00	100,00	12,00	BS	NBR	50348	rear axle	DB	007 997 8446	008354	01025712	
47275	70,00	90,00	10,00	AS W LD	FPM	47944		DB	007 997 8746			
47276	42,00	65,00	13,00	B	FPM	47278		DB	007 997 8846			
47633	30,00	42,00	7,00	A	NBR	17728	crankshaft	DB	007 997 8847	203408		
47279	42,00	60,00	10,00	B	NBR	18169		DB	007 997 8946	040339		
47634	90,00	110,00	8,00	B	NBR	47993		DB	007 997 9047			
97053	70,00	90,00	10/14	combi	NBR	114383	gearbox	DB	007 997 9646		01029728	
47280	45,00	67,00	12/13	A/BS RD W	ACM	50166	crankshaft	DB	007 997 9746			
47635	80,00	100,00	10,00	AW/BS WD	FPM	47995	differential	DB	007 997 9847			
47282	85,00	105,00	13,00	BS	NBR	32425	gearbox	DB	007 997 9946	096067	12011359	81-35092-00
47283	85,00	105,00	13,00	B WD	FPM	36789	rear axle	DB	008 997 0046	008680		81-35089-00
47284	36,00	54,00	7,00	B	NBR	50806		DB	008 997 0146			
47286	46,00	68,00	12,00	C	NBR	95185	gearbox	DB	008 997 0246	008362		
37130	28,00	40,00	7,00	B	NBR	33354		DB	008 997 0346			
47287	38,00	52,00	10,00	B	NBR	51486	gearbox	DB	008 997 0446	039780		
47636	45,00	67/72,00	12/13	AS W RD	FPM	47996	crankshaft	DB	008 997 0447	284785	12012247	

dph-no	dim 1	dim 2	dim 3	Style	Material	dph oil seal no.	Application	Type	OEM-NO	Elring	Corteco	Reinz
47288	52,00	72,00	12,00	BS	NBR	35095	gearbox	DB	008 997 0546	091901		
37326	45,00	67/72,00	12/13	AS W RD	FPM	47996	crankshaft	DB	008 997 0547	284785	12012247	
114691	55,00	68,00	8,00	AS/B	ACM	37352	crankshaft	DB	008 997 0647		12014730	
47637	68,00	90,00	13,00	BS RD	FPM	47947	differential	DB	008 997 0747	331171	12012074	81-35083-00
47638	68,00	90,00	13,00	BS RD	FPM	47947	differential	DB	008 997 0847	331171	12012074	81-35083-00
47639	20,00	30,00	7,00	B	NBR	17506		DB	008 997 1047			
32871	58,00	75,00	12,00	C blue	NBR	50807	gearbox	DB	008 997 1146	043932	01003273	
47289	48,00	65,00	12,00	B	NBR	47290		DB	008 997 1246	460915		
47291	33,00	50,00	8,00	B	NBR	97159		DB	008 997 1346			
47292	65,00	90,00	15,00	B RD	FPM	47957	crankshaft	DB	008 997 1446	283983		
47640	45,00	74,5/79,5	12/13	A SP RD	FPM/ACM	47997	crankshaft	DB	008 997 1547	309028	12010743	
47641	45,00	74,50	12/14,50	A SP RD	FPM/ACM	47997	crankshaft	DB	008 997 1647	309028	12010743	
47643	46,00	64,00	8,00	B RD	FPM	47998	gearbox	DB	008 997 1947	283827		
47293	75,00	95,00	10,00	C	NBR	18657	engine various	DB	008 997 2146			
47294	75,00	95,00	13,00	A/BS	NBR	48021	rear axle	DB	008 997 2246			
47296	45,00	74,50	12/14,50	A SP RD	FPM/ACM	47997	crankshaft	DB	008 997 2346	309028		
47297	34,00	52,00	8,00	A	NBR	17888	automatic gearbox	DB	008 997 2546	048364		
47644	93,00	117,00	12,00	BS LD LA	FPM	6648	crankshaft	DB	008 997 2547	344230		
15262	93,00	117,00	12,00	BS LD LA	FPM	6648	crankshaft	DB	008 997 2647	344230	12012246	81-25242-00
47645	60,00	80,00	10,00	C	NBR	51483	rear axle	DB	008 997 2947	041513		
47646	37,00	61,00	10/14	AW/B RD SP	ACM	47999	differential	DB	008 997 3147	586994	01019477	81-35071-00
47647	37,00	78,30	8,00	AW/B WD SP	ACM	48000	rear axle	DB	008 997 3247	587001	01019475	81-35072-00
15266	38,00	52,00	10,00	B	NBR	51486	gearbox	DB	008 997 3346	039780	12011499	
47648	85,00	105,00	10,00	B LD	FPM	4047	gearbox	DB	008 997 3347	033464	12013757	
47649	30,00	47,00	8,00	AS	NBR	19169		DB	008 997 3547	206806		
47650	40,00	70,00	7/8	B	FPM	47987	differential	DB	008 997 3647		12015261	
47651	48,00	75,00	8,00	B RD	FPM	4545	gearbox	DB	008 997 3847	033472	12011307	
47652	45,00	67,00	12/13	A/BS RD W	ACM	50166	crankshaft	DB	008 997 4047	287202		
47653	72,00	84/85,6	18,00	BS	NBR	48057	rear axle	DB	008 997 4147			
47298	40,00	62,00	12/16	SP	ACM	116560	differential	DB	008 997 5146	219568		
47654	45,00	67,00	12/13,00	BS RD LA	FPM	36211	crankshaft	DB	008 997 5247	305529	12012247	81-21023-30
112560	142,50	175,00	13/16	AS W WD	NBR	113069	crankshaft	DB	008 997 5847		01017574	
47299	115,00	150,00	13,00	C	NBR	18892	rear axle	DB	008 997 6046	044660		
47300	125,00	150,00	15,00	C	NBR	50804	rear axle	DB	008 997 6146			
37038	55,00	68,00	8,00	AS/B	ACM	37352	crankshaft	DB	008 997 6147		12014730	

dph-no	dim 1	dim 2	dim 3	Style	Material	dph oil seal no.	Application	Type	OEM-NO	Elring	Corteco	Reinz
47301	110,00	140,00	13,00	C	NBR	50802	rear axle	DB	008 997 6246	612103	12011404	
47302	25,00	35,00	8,00	A D	NBR	47303	steering	DB	008 997 6346	008427		
47304	45,00	67,00	12/13	A/BS RD W	ACM	50166	crankshaft	DB	008 997 7046	287202		
47305	55,00	75,00	8,00	B RD	FPM	36792	gearbox	DB	008 997 7246	284645		
47306	30,00	40,00	7,00	B	NBR	6451	crankshaft	DB	008 997 7346	038814		
47655	80,00	100,00	10,00	AW/BS WD	FPM	47995	gearbox	DB	008 997 7547		01016881	
84478	45,00	50,00	3,00	BO	NBR	42762	hub axle	DB	008 997 7746		01020632	
47657	40,00	70,00	7/8	B	FPM	47987	differential	DB	008 997 8147		12015261	
95963	8,90	15,80	13,00	SP blue	NBR	104491	crankshaft	DB	008 997 9047		01026500	
34036	34,00	52,00	8,00	A	NBR	17888	automatic gearbox	DB	008 997 9146	048364	01010901	
36988	40,00	62,00	10,00	A	NBR	18107	automatic gearbox	DB	008 997 9246	330809	12010936	81-21001-20
47307	72,00	105,00	13,00	CS	NBR	50344	front axle	DB	008 997 9446			
93878	26,00	37,00	7/8	AS V W	NBR	47945	steering	DB	008 997 9447	006408	12014826	
15269	50,00	68,40	10/14,3	BS SP blue	NBR	116341	wheel hub	DB	008 997 9646	008028		
34018	50,00	70,00	8,00	C blue	NBR	61496	front axle	DB	008 997 9746	108642	01020675	
47308	15,00	24,00	7,00	B	NBR	17404	manual gearbox	DB	008 997 9846	037133	01002376	
47309	185,00	210,00	13,00	A	NBR	6369	rear axle	DB	009 997 0046	563617	12011099	81-35117-00
82808	17,00	28,00	6,00	B DUO	NBR	4491		DB	009 997 0047			
6653	30,00	43,00	8/5,50	AS SP blue	NBR	32849		DB	009 997 0147		01019307	
47310	135,00	165,00	13/10	C	NBR	50339	rear axle	DB	009 997 0246			
47311	135,00	165,00	13/15	BS	NBR	48046	rear axle	DB	009 997 0346			
47312	68,00	90,00	10/9,50	B WD	FPM	47989	rear axle	DB	009 997 0446	008508		
47313	68,00	90,00	10,00	BS	NBR	95922	rear axle	DB	009 997 0546	008303	01026650	
47317	80,00	100,00	12,00	B	FPM	47315		DB	009 997 0646	042420		
47659	105,00	130,00	12,00	AS	NBR	97860		DB	009 997 0647	282200	12013364	
47318	80,00	100,00	12,00	BS	NBR	50348	rear axle	DB	009 997 0746	008354	01025712	
47660	105,00	130,00	12/9,5	AW/BS LD	ACM	95476		DB	009 997 0747	314994	01018282	
47321	72,00	105,00	13,00	BS	NBR	4767	front & rear axle	DB	009 997 1046			
6550	85,00	105,00	13,00	BS blue	NBR	32425	gearbox	DB	009 997 1146	096067	12011359	
47322	85,00	105,00	13,00	B WD	FPM	36789	rear axle	DB	009 997 1246	008680		81-35089-00
47323	75,00	95,00	10/9,50	B WD	FPM	4380	transfer gearbox	DB	009 997 1446	327263		
47324	75,00	95,00	12,50	BS	NBR	50347	camshaft	DB	009 997 1546	008370	01019460	
47325	60,00	65,00	10/8	A	NBR	48049	crankshaft	DB	009 997 1646		12011000	
47326	165,00	190,00	13,00	BS	NBR	47254	front axle	DB	009 997 1846		01002897	
82226	45,00	65,00	10,00	AW/B WD	ACM	37514	rear axle	DB	009 997 2247			

dph-no	dim 1	dim 2	dim 3	Style	Material	dph oil seal no.	Application	Type	OEM-NO	Elring	Corteco	Reinz
47327	40,00	62,00	12/16	SP	ACM	116560	differential	DB	009 997 2346	219568		
47661	100,00	120,00	10,00	A W LD	FPM	48007	transmission	DB	009 997 2447		12013550	
81806	40,00	50,00	8,00	BS	FPM	81805		DB	009 997 2847			
48050	42,00	58,00	7,00	BS	NBR	37347	rear axle	DB	009 997 3046	010197		
114575	38,00	50,00	7,00	A	NBR	70214	crankshaft	DB	009 997 3146		12010923	
47329	50,00	70,00	13,5/8	BS SP	NBR	37350	front axle	DB	009 997 3346	009075	12012696	
47662	105,00	130,00	12,00	AW/BS RD vlies	FPM	112532	crankshaft	DB	009 997 3447	524972	12014447	
47663	93,00	117,00	12,00	BS LD LA	FPM	6648	crankshaft	DB	009 997 3647	344230		
47331	72,00	105,00	13,00	BS	NBR	4767	front & rear axle	DB	009 997 4546	008559	12012573	
36153	45,00	74,5/79,5	12/13	A SP RD	FPM/ACM	47997	crankshaft	DB	009 997 4547	309028	12010743	
47332	48,00	69,00	10,00	B RD	FPM	47988	gearbox	DB	009 997 4646			
47333	48,00	65,00	10,00	B	NBR	81637	gearbox	DB	009 997 4746	040991		
47334	45,00	60,00	8,00	A	NBR	18213		DB	009 997 4846			
47335	125,00	160,00	18,00	BS LD F	FPM	36207	crankshaft	DB	009 997 5146	316385	12012432	
47664	35,00	52,00	10,00	A	NBR	17934	crankshaft	DB	009 997 5147	258407	12010908	
61355	18,00	30,00	7/8	AS	NBR	4536	crankshaft	DB	009 997 5247		12011517	
47336	70,00	85,00	8,00	B	NBR	18606		DB	009 997 5746			
51744	85,00	105,00	10,00	B LD	FPM	4047	gearbox	DB	009 997 5947		12013757	
48067	65,00	90,00	15,00	B RD	FPM	47957	crankshaft	DB	009 997 6146	283983		
47340	65,00	90,00	15,00	B RD	FPM	47957	crankshaft	DB	009 997 6246	283983		
47665	52,00	72,00	12,00	BS WD	FPM	47951	differential	DB	009 997 6347	006564		
47666	30,00	40,00	7,00	B	NBR	6451	crankshaft	DB	009 997 6447	038814		
36425	64,00	80,00	13,00	AS blue	NBR	61497	front axle	DB	009 997 6647	008591		
98403	26,00	31,00	3,00	B OF	NBR	51395	steering knuckle pin	DB	009 997 6746		01029621	
46760	100,00	130,00	13,00	AW/BS	NBR	61447	front-/rear axle	DB	009 997 6747	232459	12000552	81-33861-00
47667	65,00	90,00	10,00	C	FPM	48036	crankshaft	DB	009 997 7047		01029759	
61443	28,00	40,00	7,00	AS	NBR	93614	crankshaft	DB	009 997 7246			
36426	64,00	80,00	13,00	AS blue	NBR	61497	front axle	DB	009 997 7546	008591		
47668	64,00	80,00	13,00	AS blue	NBR	61497	front axle	DB	009 997 7547	008591		
47341	95,00	120,00	13,00	C	NBR	51723	rear axle	DB	009 997 7646			
47669	65,00	90,00	15,00	B RD	FPM	47957	crankshaft	DB	009 997 7747		20027937	
47342	80,00	100,00	12,00	BS	NBR	50348	rear axle	DB	009 997 7846	008354		
47343	45,00	62,00	10/12	BS	NBR	15244	front axle	DB	009 997 8246			
48037	45,00	74,5/79,5	12/13	A SP RD	FPM/ACM	47997	crankshaft	DB	009 997 8547	312010	12010743	
4046	170,00	190,00	8,50	AS K	NBR	4045	rear axle	DB	009 997 8846	327255	12012577	

dph-no	dim 1	dim 2	dim 3	Style	Material	dph oil seal no.	Application	Type	OEM-NO	Elring	Corteco	Reinz
47671	45,00	67,00	8,00	ASW RD	FPM	36206	crankshaft	DB	009 997 8947			
93379	120,00	150,00	15/12	CS	NBR	48002	front axle	DB	009 997 9046		12011418	
109057	93,00	114,00	14,00	AS W LD	FPM	48028	crankshaft	DB	009 997 9047			
47344	72,00	105,00	13,00	BS	NBR	4767	front&rear axle	DB	009 997 9146	008559	12012573	
47672	95,00	120,00	13,00	A/BS	NBR	48026	wheel hub	DB	009 997 9247	567787	12015264	
47673	65,00	90,00	13,00	AW/BS RD VL	FPM	84257	crankshaft	DB	009 997 9447		12014380	
47345	145,00	175,00	13,00	C	NBR	6729	rear axle	DB	009 997 9546			
47346	145,00	175,00	14,00	BS	NBR	4376	rear axle	DB	009 997 9646	002313		
47347	25,00	35,00	7,00	AS	NBR	84590	injection pump	DB	009 997 9746	038075	12011122	
51489	112,00	132,00	7,50	BAB	FPM	51488		DB	009 997 9747			
47348	185,00	210,00	13,00	A	NBR	6369	rear axle	DB	010 997 0046	563617	12011099	81-35117-00
47674	90,00	110,00	13,00	A/BS	NBR	48024	rear axle	DB	010 997 0147	567779	12015249	
51472	75,00	95,00	15,50	AW/BS WD	FPM	51471	differential	DB	010 997 0547		01025711	
36666	45,00	67,00	8,00	AS W RD	FPM	36206	crankshaft	DB	010 997 0947		12012248	
32592	38,00	43,00	3,00	BO	NBR	32154		DB	010 997 1246			
47349	57,00	75,00	7,5/6	AS K	NBR	48052	front axle	DB	010 997 1746	008664	01020674	
114604	46,00	68,00	12,00	A/BS RD	FPM	114340	gearbox	DB	010 997 2146		01019885	
47351	48,00	80,00	12/18	BS2	HNBR	48053		DB	010 997 2246	109916		
47352	26,00	36,00	7,00	AS	NBR	19362	gearbox	DB	010 997 2346		01027966	
47353	70,00	90,00	10,00	B	NBR	18612	crankshaft	DB	010 997 2446	246891	12011533	
47676	95,00	115,00	13,00	A/BS blue	NBR	48025	wheel hub	DB	010 997 2447	567795	12015263	81-35094-00
47354	19,60	33,00	8/9	AS	NBR	68850	steering	DB	010 997 2546			
47355	46,00	64,00	8,00	B RD	FPM	47998	gearbox	DB	010 997 2946	283827	12015259	
47356	160,00	180,00	10,00	B	NBR	68846	front axle	DB	010 997 3046	008818		
47357	160,00	180,00	10,00	A/BS	NBR	94701	front axle	DB	010 997 3146	008672	01019887	
36227	45,00	67,00	8,00	ASW RD	FPM	36206	crankshaft	DB	010 997 3347		12012248	
47358	60,00	95,00	8/10	AS	NBR	48054		DB	010 997 3446			
47677	45,00	67,00	12/13	A/BS RD W	ACM	50166	crankshaft	DB	010 997 3447			
46819	45,00	67/72	10/14	AS RD SP W	NBR	46819	crankshaft	DB	010 997 3447			
47359	60,00	95,00	8/10	AS	NBR	48054		DB	010 997 3546			
36790	85,00	105,00	13,00	B WD	FPM	36789	rear axle	DB	010 997 3646	008680	12012549	81-35089-00
95793	120,00	140,00	13,00	AW/BS LD	FPM	112531	crankshaft	DB	010 997 3647			
47360	72,00	105,00	13,00	C WD	FPM	48048	front axle	DB	010 997 3746	008745	12014743	
82177	50,00	58,00	4,00	BO	NBR	22997	stub axle	DB	010 997 4146			
114605	48,00	65,00	10,00	AW/BS RD	FPM	36203	crankshaft	DB	010 997 4247	586676	01026868	

dph-no	dim 1	dim 2	dim 3	Style	Material	dph oil seal no.	Application	Type	OEM-NO	Elring	Corteco	Reinz
80383	35,00	50,00	7,00	A/B RD	FPM	50167	crankshaft	DB	010 997 4547		01020122	
84414	160,00	185,00	13,00	BS	NBR	18967	crankshaft	DB	010 997 4646		12011376	
61237	43,00	58,00	7,00	A/B RD	FPM	37533	automatic gearbox	DB	010 997 4847			
84412	43,00	58,00	7,00	A/B RD	FPM	37533	automatic gearbox	DB	010 997 4947	466042	01020045	
47361	68,00	90,00	10,00	A	NBR	18598	crankshaft	DB	010 997 5046	251720		
48185	43,00	58,00	7,00	A/B RD	FPM	37533	gearbox automatic	DB	010 997 5047	466042	01020045	
51726	65,00	90,00	15,00	B RD	MVQ	51726	crankshaft	DB	010 997 5247			
47679	65,00	90,00	13,00	AW/BS RD F	FPM	84257	crankshaft	DB	010 997 5247	283983		81-20504-10
47362	72,00	105,00	13,00	C WD	FPM	48048	front axle	DB	010 997 5346	008745	12014743	
47680	90,00	110,00	13,00	A/BS	NBR	48024	rear axle	DB	010 997 5347	567779	12015249	
47363	85,00	105,00	13,00	B WD	FPM	36789	rear axle	DB	010 997 5446	008680	12012549	
47681	95,00	115,00	13,00	A/BS blue	NBR	48025	wheel hub	DB	010 997 5447	567795		81-35094-00
47364	64,00	80,00	13,00	AS blue	NBR	61497	front axle	DB	010 997 5546	008591		
47682	95,00	120,00	13,00	A/BS	NBR	48026	wheel hub	DB	010 997 5547	567787	12015264	
47366	68,00	90,00	13,00	BS RD	FPM	47947	differential	DB	010 997 5746	331171		81-35083-00
47683	75,00	95,00	13,00	A/BS	NBR	48021	rear axle	DB	010 997 5747	562866	12015884	
47367	46,00	64,00	8,00	B RD	FPM	47998	gearbox	DB	010 997 5946	283827		
47368	70,00	90,00	10,00	B	NBR	18612	crankshaft	DB	010 997 6046	246891	12011533	
47684	30,00	40,00	7,00	AS RD W	FPM	47982	camshaft	DB	010 997 6147	589993	20020461	
47370	26,00	36,00	7,00	AS	NBR	19362	gearbox	DB	010 997 6246			
47685	30,00	40,00	7,00	AS RD W	FPM	47982	camshaft	DB	010 997 6247			
47686	50,00	70,00	13,5/8	BS SP	NBR	37350	front axle	DB	010 997 6547	009075	12012696	
47687	50,00	70,00	13,5/8	BS SP	NBR	37350	front axle	DB	010 997 6647	009075	12012696	
37351	50,00	70,00	13,5/8	BS SP	NBR	37350	front axle	DB	010 997 6747	009075	12012696	
47688	25,00	35,00	7,00	AS	NBR	84590	injection pump	DB	010 997 6947			
80225	100,00	124,00	15,00	AS LD	MVQ	80224		DB	010 997 7046			
47689	75,00	95,00	13,00	A/BS	NBR	48021	rear axle	DB	010 997 7147	562866	12015884	
114684	52,00	72,00	8,00	A W	FPM	114349	crankshaft	DB	010 997 7246		01012588	
47371	26,00	37,00	7,00	AS	NBR	32164	gearbox	DB	010 997 7346		01201127	
47372	40,00	70,00	12/16	SP RD	ACM	48005	rear axle	DB	010 997 7846	312444		81-35073-00
47690	115,00	140,00	13,00	A/BS blue	NBR	48022	rear axle	DB	010 997 7847	562882	12015887	
47691	115,00	140,00	13,00	A/BS blue	NBR	48022	rear axle	DB	010 997 7947	562882	12015887	
47692	120,00	145,00	15/12	A/BS	NBR	48023	wheel hub	DB	010 997 8047	567108	12015886	
47693	120,00	145,00	13,00	CS	NBR	51716	front & rear axle	DB	010 997 8147	567108	12015886	
36224	93,00	117,00	12,00	BS LD LA	FPM	6648	crankshaft	DB	010 997 8247	344230	12012246	81-25242-00

dph-no	dim 1	dim 2	dim 3	Style	Material	dph oil seal no.	Application	Type	OEM-NO	Elring	Corteco	Reinz
93298	25,00	35,00	7,00	A DUO	FPM	93360		DB	010 997 8347			
47694	115,00	140,00	13,00	A/BS blue	NBR	48022	rear axle	DB	010 997 8447	562882	12015887	
47695	120,00	145,00	15/12	A/BS	NBR	48023	wheel hub	DB	010 997 8547	567108		
47696	90,00	110,00	13,00	A/BS	NBR	48024	rear axle	DB	010 997 8647	567779	12015249	
47697	95,00	115,00	13,00	A/BS blue	NBR	48025	wheel hub	DB	010 997 8747	567795	12015263	
47698	95,00	120,00	13,00	A/BS	NBR	48026	wheel hub	DB	010 997 8847	567787	12015264	
47699	45,00	67,00	10,00	ASW RD	FPM	48027	crankshaft	DB	010 997 8947			
36647	100,00	130,00	13,00	AS	NBR	4377	front & rear axle	DB	010 997 9046	814172	12000552	
36226	93,00	114,00	14,00	AS W LD	FPM	48028	crankshaft	DB	010 997 9047		12012249	
47373	100,00	130,00	13,00	AS	NBR	36648		DB	010 997 9146			
47374	48,00	75,00	8,00	B RD	FPM	4545	gearbox	DB	010 997 9246	033472		
47700	46,00	64,00	8,00	B RD	FPM	47998	gearbox	DB	010 997 9447	283827	12015259	
47375	50,00	65,00	8,00	B	NBR	18316	wheel hub	DB	010 997 9646	041114	01020676	
47701	70,00	90,00	10,00	B	NBR	18612	gearbox	DB	010 997 9647	246891	12011533	
15267	50,00	65,00	8,00	B	NBR	18316	wheel hub	DB	010 997 9746	041114		
47376	145,00	175,00	14,00	BS	NBR	4376	rear axle	DB	011 997 0046	002313	12011374	81-91002-00
81021	145,00	175,00	14,00	A/BS	NBR	81021	rear axle	DB	011 997 0046			
47377	145,00	175,00	13,00	A/B W blue	NBR	82427	rear axle	DB	011 997 0146	294500	12014407	81-91001-00
96495	56,00	70,00	9/6	AS SP	NBR	80858	steering	DB	011 997 0346	235350		
47378	40,00	70,00	12/16	SP RD	ACM	48005	rear axle	DB	011 997 0446	312444	12015258	81-35073-00
47380	72,00	84/85,6	18,00	BS	NBR	48057	rear axle	DB	011 997 0546			
15261	72,00	84/85,6	18,00	BS	NBR	48057	rear axle	DB	011 997 0646	018813	16011841	
47703	93,00	114,00	14,00	AS W LD	FPM	48028	crankshaft	DB	011 997 0647			
36407	145,00	175,00	13,00	A/B W blue	NBR	82427	rear axle	DB	011 997 1246		12014407	
47704	65,00	85,00	10,00	AS	NBR	18566	crankshaft	DB	011 997 1247		12011195	
47381	105,00	130,00	12,00	AW/BS RD vlies	FPM	112532	crankshaft	DB	011 997 1346	524972		
114750	75,00	95,00	12/13	A/BS RD Vlies	FPM	112929	crankshaft	DB	011 997 1447		01026179	
47382	148,00	170,00	15,00	C	NBR	18953		DB	011 997 1646			
47383	160,00	180,00	10,00	A/B WD	NBR	94702	front axle	DB	011 997 1746		01019888	
47384	160,00	180,00	10,00	A/BS	NBR	94701	front axle	DB	011 997 1846	008672	01019887	
47705	80,00	100,00	10,00	A green	NBR	4306	front-/rear axle	DB	011 997 1847			
47385	25,00	32,00	5,00	B OF	NBR	48055	gearbox	DB	011 997 2246	134600	01002919	
47707	45,00	74,5/79,5	12/13	A SP RD	FPM/ACM	47997	crankshaft	DB	011 997 2247		12010743	81-17328-20
47386	148,00	170,00	15,00	C	NBR	18953		DB	011 997 2346			
47709	36,00	54,00	7,00	B	NBR	50806		DB	011 997 2347			

dph-no	dim 1	dim 2	dim 3	Style	Material	dph oil seal no.	Application	Type	OEM-NO	Elring	Corteco	Reinz
47387	75,00	95,00	13,00	CS	NBR	51719	gearbox	DB	011 997 2546	529001	12013987	
47388	100,00	130,00	13,00	AS	NBR	4377	front & rear axle	DB	011 997 2646	814172	12000552	
47389	145,00	175,00	13,00	C	FPM	97801	axle	DB	011 997 3146	033146		
47390	70,00	90,00	10,00	B	NBR	18612	crankshaft	DB	011 997 3346	246891		
22999	50,00	58,00	4,00	BO	NBR	22997	stub axle	DB	011 997 3546		01012190	
47391	100,00	130,00	13,00	AS	NBR	4377	front & rear axle	DB	011 997 3646	814172	12000552	
112801	143,00	165,00	8,50	BABSL	NBR	112800	crankshaft	DB	011 997 3746		01030092	
47392	145,00	175,00	13,00	C	FPM	97801	axle	DB	011 997 3846	033146		
47393	44,00	60,00	8,00	B RD LA	MVQ	15241	gearbox	DB	011 997 3946	319104		
47394	85,00	105,00	13,00	BS	NBR	32425	gearbox	DB	011 997 4246	096067		81-35092-00
4375	145,00	175,00	13,00	A/B W blue	NBR	82427	rear axle	DB	011 997 4346		12011407	
4440	145,00	175,00	14,00	BS green	NBR	4376	rear axle	DB	011 997 4446	002313	12011374	
114722	65,00	85,00	15,50	A/BS WD	FPM	114369	transfer gearbox	DB	011 997 4447	451120	01029680	
47395	25,00	35,00	7,00	AS	NBR	84590	injection pump	DB	011 997 4746	038075	12011122	
47396	50,00	70,00	13,5/8	BS SP	NBR	37350	front axle	DB	011 997 5146	009075		
37517	45,00	64,00	12/7	SP WD	NBR	48029	front axle	DB	011 997 5147	578134	12012039	81-35076-00
47710	145,00	175,00	13,00	A/B W blue	NBR	82427	rear axle	DB	011 997 5247	208220		
47711	145,00	175,00	13,00	A/B W blue	NBR	82427	rear axle	DB	011 997 5347			
47397	115,00	140,00	13,00	CS	NBR	51724	front axle	DB	011 997 5446	518166	12003473	81-35102-00
114015	28,00	52,00	7,00	B	NBR	51524	crankshaft	DB	011 997 5447		01002476	
82217	38,00	62,00	7,00	B	NBR	20008		DB	011 997 5546			
47712	50,00	70,00	13,5/8	BS SP	NBR	37350	front axle	DB	011 997 5547	009075	12012696	
47713	75,00	100,00	12/13,00	BS RD F	FPM	36208	crankshaft	DB	011 997 5647	525316	12011674	
36221	75,00	100,00	12/13,00	BS RD	FPM	36208	crankshaft	DB	011 997 5747	525316	12011674	81-20309-20
113951	110,00	130,00	12,00	A/BS W blue	NBR	113950	wheel hub	DB	011 997 5847		12019646	
4071	50,00	70,00	13,5/8	BS SP	NBR	37350	front axle	DB	011 997 6046	009075	12012696	
47714	45,00	64,00	12/7	SP WD	NBR	48029	front axle	DB	011 997 6147	578134		81-35076-00
82218	50,00	80,00	10,00	C	NBR	18347		DB	011 997 6646			
47398	21,00	33,00	8/9,50	AS blue	NBR	36731	steering	DB	011 997 6746	007544	01019308	
47399	75,00	100,00	12/13,00	BS RD F	FPM	36208	crankshaft	DB	011 997 6946	525316		
47400	75,00	100,00	12/13,00	BS RD F	FPM	36208	crankshaft	DB	011 997 7046	525316	12011674	
47715	72,00	105,00	13,00	BS	NBR	4767	front&rear axle	DB	011 997 7047	008559	12012573	
47716	100,00	120,00	13,00	C	NBR	18825	front axle	DB	011 997 7147	562609	12011400	
48358	28,00	40,00	8/6,00	AS SP	NBR	36704	steering	DB	011 997 7246	237744	12012574	
47717	100,00	125,00	13,00	A/BS	NBR	48030	front axle	DB	011 997 7247	562874	12015406	

dph-no	dim 1	dim 2	dim 3	Style	Material	dph oil seal no.	Application	Type	OEM-NO	Elring	Corteco	Reinz
47718	52,00	72,00	12,00	BS WD	FPM	47951	gearbox	DB	011 997 7447	006564	01016879	
47402	68,00	80,00	9/10	BS	NBR	48056		DB	011 997 7646			
46849	115,00	140,00	13,00	CS	NBR	51724	front axle	DB	011 997 7745			
82227	115,00	140,00	13,00	CS	NBR	51724	front axle	DB	011 997 7747			
47403	72,00	84/85,6	18,00	BS	NBR	48057	rear axle	DB	011 997 7846			
47404	50,80	65,00	9/9,50	AS	NBR	48040	steering	DB	011 997 7946	237752	01026321	
47405	54,80	70,00	9/7,00	AS SP	NBR	36703	steering	DB	011 997 8046	237760		
47406	48,00	65,00	12,00	B	NBR	47290		DB	011 997 8246	460915		
47407	33,00	50,00	8,00	B	NBR	97159		DB	011 997 8346			
47408	21,00	33,00	8/9,50	AS blue	NBR	36731	steering	DB	011 997 8446	007544		
47409	32,00	44,00	8/9,5	AS V	NBR	48045	steering	DB	011 997 8546	007552		
47719	85,00	105,00	12,00	B	NBR	44329	gearbox	DB	011 997 8547	033480	12011341	81-35091-00
47410	40,00	52,00	7,00	A	NBR	18068	wheel hub	DB	011 997 8846	321508		
37520	45,00	85,30	9,5/14,00	A W WD	ACM	6343	differential	DB	011 997 8847	587915		81-35148-00
47411	48,00	62,00	8,00	A	ACM	47994		DB	011 997 9446			
47720	40,00	55,00	8,00	AS W LD	ACM	50854	gearbox automatic	DB	011 997 9547			
47721	40,00	55,00	8,00	AS LD	ACM	47984		DB	011 997 9647			
47412	68,00	90,00	13,00	BS RD	FPM	47947	differential	DB	011 997 9846	331171	12012074	81-35083-00
47413	42,00	55,00	9,00	B	FPM	48010	brake cam shaft	DB	011 997 9946			
4646	85,00	105,00	10,00	B LD	FPM	4047	gearbox	DB	012 997 0647	033464	12013757	
47722	95,00	120,00	13,00	A/BS	NBR	48026	wheel hub	DB	012 997 1147	567787	12015264	
47723	160,00	180,00	10,00	A/BS	NBR	94701	front axle	DB	012 997 1947	008672	01019887	
47724	160,00	180,00	10,00	B	NBR	68846	front axle	DB	012 997 2047	008818	01019888	
47726	52,00	72,00	12,00	BS WD	FPM	47951	gearbox	DB	012 997 2947	006564	01016879	
84201	42,00	55,00	9,00	B	FPM	48010	front axle	DB	012 997 3747		01017009	
47727	40,00	55,00	8,00	AS	NBR	18078	wheel hub	DB	012 997 3847	039993	12011157	
109262	42,00	58,00	7,00	BS	NBR	37347	brake cam shaft	DB	012 997 4147			
114740	70,00	90,00	15,50	AW/BS WD	FPM	114384	transfer gearbox	DB	012 997 5247		01028962	
36222	105,00	130,00	12,00	AW/BS RD vlies	FPM	112532	crankshaft	DB	012 997 7447	524972	12014447	
114580	40,00	52,00	7,00	AS W	ACM	114334	gearbox	DB	012 997 8247	221970	01026706	
96505	22,00	32,00	7/8	AS	NBR	48039	gearbox	DB	012 997 8547			
48360	40,00	62,00	10/7	A/BS LD	NBR	37532	transfer gearbox	DB	012 997 8747		01019150	
47728	100,00	125,00	13,00	A/BS	NBR	48030	front axle	DB	012 997 9147	562874	12015406	
51423	145,00	175,00	14,00	A/BS	NBR	81021	rear axle	DB	013 997 0547	768065	12014740	81-91002-00
47730	75,00	95,00	13,00	A/BS	NBR	48021	rear axle	DB	013 997 1147	562866	12015884	81-35087-00

dph-no	dim 1	dim 2	dim 3	Style	Material	dph oil seal no.	Application	Type	OEM-NO	Elring	Corteco	Reinz
36223	120,00	140,00	13,00	AW/BS LD	FPM	112531	crankshaft	DB	013 997 1447	562920	12014877	81-23113-00
116368	100,00	130,00	11,00	AW/BS RD	PTFE/ACM	117451	crankshaft	DB	013 997 1646		20034028	
47731	40,00	70,00	13,00	special	FPM	47986		DB	013 997 1847			
112930	75,00	95,00	12/13	A/BS RD Vlies	FPM	112929		DB	013 997 2247			
47732	65,00	90,00	13,00	AW/BS RD VL	FPM	84257	crankshaft	DB	013 997 3347			
114490	145,00	175,00	15,00	A W	ACM	114456	wheel hub	DB	013 997 3546	451110	01033415	
115203	145,00	175,00	8,00	B SP	NBR	114872	wheel hub	DB	013 997 3646		01034120	
95271	26,00	37,00	7/8	AS V W	NBR	47945	steering	DB	013 997 4547			
95009	72,00	105,00	13,00	C WD	FPM	48048	front axle	DB	013 997 4947		12014743	
82990	19,05	30,00	7/8	AS RD blue	NBR	51224	crankshaft	DB	013 997 5847		01026490	
115094	130,00	170,00	18/20	KA	FPM	114448	crankshaft	DB	013 997 5946		12019945	
80835	145,00	175,00	13,00	AW/B	FPM	59311	rear axle	DB	013 997 5947	768057	12014739	81-35112-00
94399	145,00	175,00	13,00	A/B W blue	NBR	82427	rear axle	DB	013 997 6447	768065		
47733	45,00	67/72,00	10/14,50	AS RD SP W	NBR	46819	crankshaft	DB	013 997 6847			
93238	95,00	115,00	13/12	BS	NBR	93237		DB	013 997 7247		01002889	
114491	120,00	150,00	15/20,2	A/BS	NBR	114428	wheel hub	DB	013 997 7346	383260	01033873	
81121	95,00	115,00	13/12	A/B LD	FPM	93240	gearbox shaft	DB	013 997 7347	141950	01017136	
47734	48,00	64,00	12/6	BS WD	NBR	93636	wheel hub	DB	013 997 8847			
118372	145,00	175,00	16,00	AW/BS WD	FPM	82321	rear axle	DB	013 997 8946		01016689	
36646	145,00	175,00	13,00	AW/B	FPM	59311	rear axle	DB	013 997 9447	768057	12014739	
114724	65,00	90,00	10,00	AS W WD	FPM	114370	crankshaft	DB	014 997 0047		01029683	
114713	62,00	78,00	10,00	AW/BS LD	FPM	114364	gearbox	DB	014 997 0147		01016882	
114873	145,00	175,00	8,00	B SP	NBR	114872	wheel hub	DB	014 997 0546		01034120	
117052	85,00	110,00	12/17	AW/BS	FPM	117051	differential	DB	014 997 1246	504560	01033971	
69541	120,00	140,00	13,00	AW/BS LD	FPM	112531	crankshaft	DB	014 997 1347	562920	12014877	
98686	65,00	90,00	13,00	AW/BS RD VL	FPM	84257	crankshaft	DB	014 997 1646			
82131	65,00	90,00	13,00	AW/BS RD VL	FPM	84257	crankshaft	DB	014 997 1647	553272	01016759	81-20504-40
37247	42,00	58,00	7,00	BS	NBR	37347	rear axle	DB	014 997 2247			
96443	40,00	55,00	8,00	A/BS LD	FPM	97073		DB	014 997 3547		01019285	
37088	105,00	130,00	12,00	AW/BS RD vlies	FPM	112532	crankshaft	DB	014 997 4647	524973	01016267	81-23301-60
104349	105,00	130,00	12,00	AW/BS RD vlies	FPM	112532	crankshaft	DB	014 997 4648			
81898	40,00	70,00	12/16	SP RD	ACM	48005	rear axle	DB	014 997 4947	312444	12015258	
84468	33,00	56,00	11,8/9	A/B WD	ACM	84729	differential	DB	014 997 5747	388180	01019286	
69017	37,00	78,30	8,00	AW/B WD	ACM	48000	rear axle	DB	014 997 6047	587001		
84206	45,00	85,30	9,5/14,00	A W WD	ACM	6343	differential	DB	014 997 6147			

dph-no	dim 1	dim 2	dim 3	Style	Material	dph oil seal no.	Application	Type	OEM-NO	Elring	Corteco	Reinz
47735	45,00	65,00	10,00	AW/B WD	ACM	37514	rear axle	DB	014 997 6247		01019154	
69270	29,90	47,00	8,00	AW RD	FPM	47983	steering	DB	014 997 6347	582689	01034077	
98688	56,00	70,00	9,00	A	NBR	98689	crankshaft	DB	014 997 6447		01026320	
37037	55,00	68,00	8,00	AS/B	ACM	37352	crankshaft	DB	014 997 6747		12014730	
47736	65,00	90,00	13,00	AW/BS RD VL	FPM	84257	crankshaft	DB	014 997 6847			
112559	28,00	40,00	8/6,00	AS SP	NBR	36704	steering	DB	014 997 6947		01020082	
94352	52,00	65,00	9/6	A/BS SO blue	NBR	94351	crankshaft	DB	014 997 7047		01019318	
84467	73,00	94,00	9/14	A/B WD	ACM	84728	differential	DB	014 997 7247		01033977	
112939	112,00	132,00	7,50	BAB	FPM	51488		DB	014 997 8947			
112564	73,00	93,00	10/12,5	A/B WD	ACM	113928	differential	DB	014 997 9747		01020048	
113953	62,00	80,00	10,00	A/BS W blue	NBR	113952	transmission shaft	DB	015 997 0147	801230	12015885	
95611	46,00	64,00	8,00	B RD	FPM	47998	gearbox	DB	015 997 0347	701343	12015259	
97431	52,00	68,00	8,00	A/BS RD	FPM	96995	gearbox	DB	015 997 0647	141960	12018806	
97423	52,00	68,00	8,00	A/BS RD	FPM	96995		DB	015 997 1647	141960	12018806	
114690	55,00	62,00	4,00	BO	NBR	114356	stub axle	DB	015 997 3747		01026865	
80461	145,00	175/205,00	9/14	SP	NBR	80460	rear axle	DB	015 997 4047			
114609	95,00	115,00	13/12	A/B LD	FPM	93240	gearbox shaft	DB	015 997 4247		01017136	
81075	100,00	130,00	13,00	AW/BS	NBR	61447	front-/rear axle	DB	015 997 4347	814172	12000552	
95475	85,00	145,00	12/37	SP SP	FPM	95864	differential	DB	015 997 4747	447080	01017059	
82394	145,00	175/205,00	9/14	SP	NBR	80460	rear axle	DB	015 997 4947	147730	01027787	
94407	125,00	150,00	15/13	A/BS WD F	NBR	94406	rear axle	DB	015 997 5647	210294	12015501	
80826	160,00	180,00	10,00	A/BS	NBR	94701	front axle	DB	015 997 5747	008672	01019887	
95981	160,00	180,00	10,00	A/B WD	NBR	94702	front axle	DB	015 997 5847	104470	01019888	
96336	75,00	95,00	15,50	AW BS WD	FPM	51471	differential	DB	015 997 6847		01025711	
111744	90,00	110,00	15,50	A/BS WD	FPM	111743	transfer gearbox	DB	015 997 6947		01030122	
82449	36,00	54,00	7,00	AW/BS RD	FPM	82448	gearbox	DB	015 997 7747	763691	01019913	
95130	120,00	145,00	15/12	AW BS WD	FPM	95129	rear axle	DB	015 997 9347	008231	01026319	
47737	120,00	140,00	13,00	AW/BS LD	FPM	112531	crankshaft	DB	016 997 0847	562920		
84204	21,00	33,00	8/9,50	AS blue	NBR	36731	steering	DB	016 997 1447			
80859	56,00	70,00	9/6	AS SP	NBR	80858	steering	DB	016 997 1647			
82228	35,00	50,00	8/5,50	BABSL	NBR	4485	crankshaft	DB	016 997 2047		01019970	
80857	28,00	40,00	8/6,00	AS SP	NBR	36704		DB	016 997 2147			
114714	62,00	78,00	10,00	AW/BS LD	FPM	114364	gearbox	DB	016 997 3047		01016882	
114723	65,00	85,00	15,50	A/BS WD	FPM	114369	transfer gearbox	DB	016 997 4947		01029680	
51230	145,00	175,00	14,00	A/BS	NBR	81021	rear axle	DB	016 997 5647	768065	12014740	

dph-no	dim 1	dim 2	dim 3	Style	Material	dph oil seal no.	Application	Type	OEM-NO	Elring	Corteco	Reinz
84205	110,30	113,30	12/10	C	NBR	68848	front axle	DB	016 997 6347		01019319	
98428	68,00	85,00	10/9,5	A/B RD	FPM	98432	differential	DB	016 997 6647	817449		
81595	68,00	85,00	10/9,5	A/BS	NBR	96320	differential	DB	016 997 6747	830798	01016877	
84594	68,00	90,00	13,00	A/BS RD	FPM	114378	differential	DB	016 997 6847		01016880	
109518	140,00	165,00	9,5/12	AS WD SP	FPM	109519	crankshaft	DB	016 997 7547	477140	01019879	
95097	125,00	150,00	15/13	A/BS WD	FPM	95098		DB	016 997 7747	457620	19020065	81-35109-00
115629	90,00	112,66	13/9,6	A/BS	NBR	115628		DB	017 997 0147			
114633	110,00	140,00	13,00	A/BS	NBR	114414	wheel hub	DB	017 997 1147	457680	12015500	
114573	36,00	54,00	7,00	AW/BS RD	FPM	82448	gearbox	DB	017 997 1447	763691	01019913	
96337	80,00	100,00	10,00	AW/BS WD	FPM	47995	differential	DB	017 997 2547		01020467	
114730	68,00	90,00	10,00	A/B WD	FPM	114377	differential	DB	017 997 2747		01020466	
93555	85,00	105,00	9,5/13	A/BS	NBR	93553	differential	DB	017 997 2847	198430	01029595	
93556	85,00	105,00	9,5/13	A/B WD	FPM	93554	differential	DB	017 997 2947	198440	01029594	
113149	75,00	95,00	9,5/10	A/BS	NBR	114110	differential	DB	017 997 3047	104320	01020042	
111632	75,00	95,00	10,00	A/B WD	FPM	47938		DB	017 997 3147		01016962	
94339	53,00	71,00	11,50	BS WD	NBR	94338	rear axle	DB	017 997 3947	151920	01018030	
95270	70,00	90,00	10,00	AW/BS WD	FPM	114382	gearbox	DB	017 997 6647		01025713	
80452	93,00	114,00	14,00	AS W LD	FPM	48028	crankshaft	DB	017 997 7447			
93378	80,00	100,00	10,00	BS	NBR	42528	rear axle	DB	017 997 7947	104330	01020468	
112974	80,00	100,00	10,00	AS	NBR	112974	rear axle	DB	017 997 7947			
112249	85,00	145,00	12/32	SP	FPM	114402	differential	DB	018 997 1847	065510	01030110	
109470	137,00	165,00	13,50	KA SP	FPM/NBR	109471	crankshaft	DB	018 997 3347		01025609	
114729	68,00	85,00	10,00	A/B WD	FPM	114376	crankshaft	DB	018 997 5147		01029648	
82458	45,00	67,00	8,00	ASW RD	FPM	36206	crankshaft	DB	018 997 5247	914924		
36242	19,05	33,33	7,93	AS blue	NBR	95982	steering	DB	018 997 6047		01020304	
98284	80,00	105,00	10,00	SP	FPM	109859	crankshaft	DB	018 997 7147		01026470	
114758	78,00	135,00	12/21,5	SP	FPM/ACM	114392	differential	DB	018 997 7647	221710	01030117	
82551	30,00	40,00	7,00	AS RD W	FPM	47982	camshaft	DB	018 997 7947	598993	12011131	81-15512-50
120052	90,00	125,00	12,00	AS W LD	FPM	120051	gearbox	DB	018 997 8648		20034608	
111752	56,00	72,00	8,00	A/BS RD	FPM	111751		DB	019 997 0547	220900	12019647	
112762	56,00	72,00	8,00	A/BS RD	FPM	111751	transfer gearbox	DB	019 997 0647	220900	12019647	
84203	50,00	70,00	13,5/8	BS SP	NBR	37350	front axle	DB	019 997 0847	009075		
114626	100,00	130,00	13,00	AW/BS	NBR	61447	front-/rear axle	DB	019 997 4747		12016930	
84224	120,00	150,00	15/12	AW/BS	NBR	84716	wheel hub	DB	019 997 4847	457710		
82174	32,00	44,00	8/9,50	AS blue	NBR	36730		DB	019 997 5047		01025508	

dph-no	dim 1	dim 2	dim 3	Style	Material	dph oil seal no.	Application	Type	OEM-NO	Elring	Corteco	Reinz
97673	21,00	33,00	8/9,50	AS blue	NBR	36731	steering	DB	019 997 5147			
115631	90,00	120,00	12/11	A/BS blue	NBR	115630		DB	019 997 5747			
114875	75,00	100,00	11,00	AW/BS blue	NBR	114874	wheel hub	DB	019 997 5847	457120	12018888	
37089	105,00	130,00	12,00	AW/BS RD vlies	FPM	112532	crankshaft	DB	019 997 6647			
93637	48,00	64,00	12/6	BS WD	NBR	93636	wheel hub	DB	019 997 8847	293400	01019283	
114868	145,00	165,00	13,00	A/BS blue	NBR	114867	wheel hub	DB	019 997 9047		19032103	
82049	145,00	175/205,00	18/20	special	FPM	82044	rear axle	DB	020 997 0547	147731	01019245	81-91000-00
109854	72,00	105,00	19,00	SP	FPM/ACM	109858	differential	DB	020 997 0647	023330	01026188	
114709	60,00	80,00	7,00	A W	FPM	114362	gearbox	DB	020 997 1247		12019243	
114710	60,00	80,00	8/19	SP	FPM	114363	gearbox	DB	020 997 1347		12019242	
93635	37,00	61,00	10/14	AW/B RD SP	ACM	47999	differential	DB	020 997 1947		01019477	
84466	37,00	78,30	8,00	AW/B WD SP	ACM	48000	rear axle	DB	020 997 2047	587001	01019475	
84348	40,00	70,00	12/16	SP RD	ACM	48005	rear axle	DB	020 997 2147			
93544	45,00	85,30	9,5/14,00	A W WD	ACM	6343	differential	DB	020 997 2347		01020315	
114751	75,00	95,00	10/15	A/BS WD	FPM	114388	differential	DB	020 997 3347		01020043	
95654	145,00	175,00	17/21	A/BS2 WD SP	FPM	95653	wheel hub	DB	020 997 3947	022850	01019352	81-35223-00
112600	70,00	79,00	5,30	B OF SF	NBR	112599	stub axle	DB	020 997 4947	222000	01026376	
114655	145,00	175/205,00	9/14	SP	NBR	80460	rear axle	DB	020 997 5247			
97818	55,00	68,00	8,00	A/BS WD	FPM	97817	crankshaft	DB	020 997 5347		01030522	
114638	120,00	150,00	15/12	AW/BS	NBR	84716	wheel hub	DB	020 997 5847		12016441	
112365	47,00	78/82,00	11,00	A/BS SP RD W	ACM	109482	differential	DB	020 997 6347		01019476	
114610	95,00	115,00	13,00	AW/BS WD	FPM	114407	wheel hub	DB	021 997 0047		01029660	
113927	140,00	165,00	12/15	AS2 W	FPM	47979	front axle	DB	021 997 1147			
114669	48,00	65,00	10,00	AS W RD	AEM/PTFE	114341	crankshaft	DB	021 997 1247			
114698	55,00	80,00	8,00	A/BS RD	FPM	114359	gearbox	DB	021 997 1747	456970	01030099	
114602	45,00	67,00	8,00	ASW RD	PTFE	114339	crankshaft	DB	021 997 1847	424841	20026532	
95217	140,00	165,00	12/15	AS2 W	FPM	47979	front axle	DB	021 997 2047			
114699	55,00	80,00	8,00	A/BS RD	FPM	114359	gearbox	DB	021 997 2547	456970	01030099	
114624	100,00	130,00	12,00	AW/BS RD	PTFE/ACM	114411	crankshaft	DB	021 997 5247	369900	20029784	
113042	115,00	140,00	13,00	AW/BS LD	PTFE/ACM	114417	crankshaft	DB	021 997 5347	445600	20029785	81-36197-00
96417	105,00	130,00	12/9,5	AW/BS LD	ACM	95476	gearbox automatic	DB	021 997 6447		01016923	
109592	124,00	150,00	14,30	SP	NBR	109591		DB	021 997 6947	220450	01028965	
115782	45,00	67,00	8,00	AS W RD	PTFE	114339	crankshaft	DB	021 997 7647	424841		81-26248-10
114676	50,00	65,00	8,00	AS W LD	FPM	114345	gearbox	DB	021 997 8047		01030104	
115480	85,00	155,00	12/33	SP	FPM	114403	differential	DB	021 997 8547	220660	01027938	

dph-no	dim 1	dim 2	dim 3	Style	Material	dph oil seal no.	Application	Type	OEM-NO	Elring	Corteco	Reinz
109594	86,00	105,00	5/6	AS SP W	NBR	109593	wheel hub	DB	021 997 8947		12016794	
114719	64,00	80,00	11,5/16	AS W	NBR	114368	stub axle	DB	022 997 0047		01026493	
114741	70,00	95,00	13/14,5	KA SP	NBR	110618		DB	022 997 1247	354080		
109784	100,00	120,00	11/16,5	BS SP	NBR	109788	wheel hub	DB	022 997 3447	477860	01030116	
97220	125,00	150,00	14,00	SP	FPM	113954	wheel hub	DB	022 997 5247	451100	01027682	
115633	136,80	165,00	13,00	KA	NBR	115632	crankshaft	DB	022 997 6247			
113041	78,00	104,00	11,00	AW/BS RD	PTFE	114391	crankshaft	DB	022 997 7647	445591	20025510	81-36198-00
112364	45,00	85,30	9,5/14,00	A W WD	ACM	6343	differential	DB	022 997 9847		01020315	
109112	40,00	70,00	11/15	A RD SP	ACM	109227		DB	022 997 9947	745720	01025661	
114611	95,00	115,00	15,50	A/BS LD	FPM	114408	gearbox	DB	023 997 1647	222830	01029684	
114603	45,00	67,00	8,00	ASW RD	PTFE	114339	crankshaft	DB	023 997 8447	424841	20026532	
98109	37,00	61,00	10/14	AW/B RD SP	ACM	47999	differential	DB	023 997 9047	268420	01019477	
109601	120,00	150,00	14,3/20	SP	FPM	109605	wheel hub	DB	024 997 4847			
119794	190,00	220,00	15,00	AS W	PTFE/ACM	119793		DB	024 997 5047			
120472	72,00	90,00	12/9,5	A/B WD	NBR	96429	crankshaft	DB	024 997 5547		01016959	
114747	75,00	90,00	10/12,3	AW/BS WD	NBR	114386	wheel hub	DB	024 997 6847		01031066	
113956	110,00	130,00	12,00	AS W	FPM	113955		DB	024 997 8547	199450		
109481	47,00	78/82,00	11,00	A/BS SP RD W	ACM	109482	differential	DB	024 997 9947		01031603	
109228	40,00	70/76,00	11/13,5	AW/BS RD SF	ACM	109304	differential	DB	025 997 0047	152940	01029803	
115942	53,00	73,00	10,00	A/BS WD	NBR	117962	magnetic oil seal	DB	025 997 1647		01033874	
116320	53,00	73,00	10,00	A/BS WD	NBR	116320	non magnetic oil seal	DB	025 997 1647			
109900	45,00	98,3/116,00	10/16,8	SP	NBR	109901		DB	025 997 2647		01031604	
117452	100,00	130,00	11,00	AW/BS RD	PTFE/ACM	117451	crankshaft	DB	025 997 3947	369901	20034028	
114781	93,00	114,00	11,50	AS W LD	PTFE	113679	crankshaft	DB	112 997 0046	524215	20031906	81-37439-00
113678	93,00	114,00	11,50	AS W LD SP	PTFE	113679	crankshaft	DB	112 997 0246		20031906	
114811	93,00	114,00	11,50	AS W LD	PTFE	113679	crankshaft	DB	112 997 0446			
61393	100,00	124,00	13,00	BS LA LD	FPM	48019	crankshaft	DB	116 997 0246	762172	01029678	81-25268-10
48712	45,00	67,00	8,00	ASW RD	FPM	36206	crankshaft	DB	120 997 0346	914924	12012248	81-26248-00
109981	80,00	100,00	9,00	A LD	PTFE	109980	crankshaft	DB	160 997 0146	745740	20030112	81-35051-00
109979	40,00	62,00	8,00	AS LD SP	PTFE	109978	crankshaft	DB	166 997 0246	745750	20026275	81-35035-00
47741	42,00	65,00	10,00	A	NBR	18181		DB	186 997 0047			
115571	48,00	68,00	9,30	A/BS	NBR	115571	non magnetic oil seal	DB	203 330 0060			
115614	48,00	68,00	9,30	A/BS	NBR	117963	magnetic oil seal	DB	203 330 0060	366230	01032572	
112366	45,00	98,3/116,00	10/16,8	SP	NBR	109901	differential	DB	210 997 0246			
47742	125,00	150,00	13,00	CS	NBR	81334	crankshaft	DB	303 997 0147	635600		

dph-no	dim 1	dim 2	dim 3	Style	Material	dph oil seal no.	Application	Type	OEM-NO	Elring	Corteco	Reinz
47743	115,00	140,00	13,00	A	NBR	18885	rear axle	DB	303 997 0647	019364		
47745	60,00	80,00	10,00	A	NBR	81629	crankshaft	DB	303 997 0947	041491	12010999	
47746	60,00	90,00	10,00	A	NBR	18510	crankshaft	DB	303 997 1047	479004	12011002	
47747	42,00	65,00	13,00	B	FPM	47278		DB	303 997 1247			
4500	165,00	190,00	13,00	A blue	NBR	4374	crankshaft	DB	304 997 0447	675407	12011096	
47748	65,00	90,00	10,00	A	NBR	18573		DB	304 997 0547			
47750	70,00	90,00	10,00	A	NBR	18610		DB	304 997 0747			
47751	70,00	90,00	10,00	AS	NBR	18611	crankshaft	DB	304 997 0847		12011015	
47752	60,00	85,00	10,00	AS green	NBR	82395		DB	304 997 0947		12011000	
47753	165,00	190,00	13,00	A blue	NBR	4374	front-/rear axle	DB	304 997 1147	675407		
47754	42,00	65,00	13,00	B	FPM	47278		DB	304 997 1247			
47755	45,00	62,00	10,00	A	NBR	18223	crankshaft	DB	304 997 1347	367206	12010954	
47756	55,00	80,00	13,00	BS	NBR	19125		DB	304 997 1547			
47757	18,00	30,00	7,00	B	NBR	19149		DB	304 997 1647			
6477	185,00	210,00	13,00	A blue	NBR	6369	rear axle	DB	304 997 1747	563617	12011099	
94506	24,00	52,00	10,00		FEFZ	94506	crankshaft	DB	315 030 0080	171557		70-20311-00
47758	150,00	180,00	13,00	AS	NBR	6713	front & rear axle	DB	317 997 0047		12011091	
47759	150,00	180,00	14,00	AS	NBR	44260	crankshaft	DB	335 997 0047		12011215	
109815	65,00	90,00	13,00	AW/BS RD VL	FPM	84257	crankshaft	DB	344 997 7446	553272		
47415	75,00	100,00	12/13,00	BS RD F	FPM	36208	crankshaft	DB	345 997 7746	525316		
81765	100,00	120,00	13/10	C	NBR	50801	front axle	DB	345 997 8446			
47416	42,00	58,00	7,00	BS	NBR	37347	rear axle	DB	350 997 7346	010197		
47417	42,00	55,00	9,00	B	FPM	48010	front axle	DB	350 997 7446			
47418	40,00	52,00	7,00	A	NBR	18068	wheel hub	DB	350 997 7746	321508		
115624	121,03	160,30	30,15	LA	NBR	115624		DB	386 997 7247			
47419	105,00	130,00	12,00	AW/BS RD vlies	FPM	47978	crankshaft	DB	403 997 0146	524972		
47420	68,00	80,00	9/10	BS	NBR	48056	crankshaft	DB	603 997 0046			
47421	72,00	84/85,6	18,00	BS	NBR	48057	rear axle	DB	603 997 0346		20017102	
47422	20,00	35,00	7,00	B	NBR	17514		DB	603 997 0446			
47423	20,00	35,00	8,00	B	NBR	42601		DB	608 997 0446			
47425	55,00	70,00	8,00	BS	NBR	44378		DB	608 997 0846			
47426	20,00	35,00	8,00	B	NBR	42601		DB	608 997 0946			
47427	40,00	52,00	7,00	B	NBR	68543	gearbox	DB	608 997 1246	039918		
47428	55,00	70,00	8,00	A	NBR	18407	wheel hub	DB	608 997 1346	440302	12010981	
110503	93,00	155,00	15,50	KA	PTFE	114782	crankshaft	DB	611 010 0114	746400	20030144	81-90002-00

dph-no	dim 1	dim 2	dim 3	Style	Material	dph oil seal no.	Application	Type	OEM-NO	Elring	Corteco	Reinz
118371	28,00	40,00	8/6,00	AS SP	NBR	36704		DB	616 997 0146		01034698	
114715	62,00	80/86	9/14	KA	NBR	114365	wheel hub	DB	905 997 0246	453910	01029698	
109599	150,00	196,00	16,00			109599	ABS	DB	942 356 0315	458 700		
109785	75,00	110/134,00	10/17	BS SP	NBR	109790	axle, with pulse wheel	DB	970 997 0446		01033904	
111398	160,00	190,00	15,00	AS W LD	FPM	111397	crankshaft	DEUTZ	0009 4765			
118609	12,00	16,00	3,00	A O W	NBR	113618	crankshaft	DEUTZ	103 2872		01032872	
117256	25,00	42,00	10/7	A/BS WD	FPM	113739		DEUTZ	113 2992			
94690	45,00	72,00	15,00	AS2W WD	NBR	37510	steering	DEUTZ	115 3906			
114598	45,00	65,00	10,00	C	NBR	18236	crankshaft	DEUTZ	115 4490		01003181	
80241	150,00	172,00	18,00	AT W LD	MVQ	68548	crankshaft	DEUTZ	116 0383	043095		81-21395-10
116028	28,00	40,00	7,00	A	NBR	17697	crankshaft	DEUTZ	116 0652	164500		
117315	28,00	47,00	10/7	A/BS WD	FPM	113738		DEUTZ	116 0655			
114562	30,00	50,00	10,00	A	NBR	17754	crankshaft	DEUTZ	116 0750		12010885	
115678	30,00	62,00	12,00	AS	NBR	32023		DEUTZ	116 0752			81-22529-10
82333	25,00	40,00	10,00	A	NBR	17619	crankshaft	DEUTZ	116 0989			
98094	25,00	42,00	10,00	AW	MVQ	98129	gearbox	DEUTZ	116 2568			
98093	28,00	47,00	10,00	A	MVQ	98091		DEUTZ	116 2569			
84559	60,00	80,00	10,00	A	NBR	81629	crankshaft	DEUTZ	116 3205			81-17085-00
95803	30,00	42,00	8/7	AS LD	NBR	82139	crankshaft	DEUTZ	116 3273		01029927	81-17539-10
80389	95,00	120,00	12,00	AS RD	ACM	68547	crankshaft	DEUTZ	116 3316	042676		81-22228-00
82337	25,00	62,00	10,00	AW/BS F	MVQ	82791	engine	DEUTZ	116 4594			
61045	68,00	85,00	10,00	A	NBR	18565	crankshaft	DEUTZ	116 5286	494402		
109167	150,00	180,00	13,00	A	NBR	6713	front-/rear axle	DEUTZ	116 7518	109657		
48063	150,00	180,00	11/13	AS	NBR	48063	front-/rear axle	DEUTZ	116 7518			
116123	105,00	130,00	13,00	A	NBR	19876	F4L514	DEUTZ	117 0229			
97054	22,00	35,00	7,00	A/BS LD	FPM	118613	crankshaft	DEUTZ	117 2559		12011664	
95572	42,00	56,00	7,00	AS W RD	FPM	82475	differential	DEUTZ	117 4560		12014404	
95573	42,00	62,00	10,00	AS RD	ACM	35050	crankshaft	DEUTZ	117 5787			
111397	160,00	190,00	15,00	AS W LD	FPM	111397	crankshaft	DEUTZ	117 5820			
117048	160,00	190,00	15,00	BS WD LA	FPM	112925		DEUTZ	117 5820			
114550	22,00	47,00	10,00	B	NBR	68545	injection	DEUTZ	121 6319			81-19473-20
114581	40,00	52,00	7,00	B	NBR	68543	gearbox	DEUTZ	121 6330	039918		
114522	17,00	37,00	10,00	A	NBR	68546		DEUTZ	121 6338	055506		
114477	90,00	110,00	12,00	AW/BS LD	FPM	15246	crankshaft	DEUTZ	1215 2257		12012579	
114649	133,00	160,00	15,00	AS W LD	FPM	114419	crankshaft	DEUTZ	1215 2280		20020505	81-23364-00

dph-no	dim 1	dim 2	dim 3	Style	Material	dph oil seal no.	Application	Type	OEM-NO	Elring	Corteco	Reinz
93641	100,00	120,00	15,00	AW/BS RD	FPM	82047	crankshaft	DEUTZ	214 8905		12012580	
81566	65,00	85,00	13/12,5	BS RD LA SP	FPM	93422	crankshaft	DEUTZ	223 4133		12012095	
50874	115,00	140,00	16,00	BS LA LD	FPM	48305	crankshaft	DEUTZ	223 4134	033376	12012148	
94055	62,00	80,00	12/11	AS W LD	MVQ	82138	crankshaft	DEUTZ	223 4498	352136	01034681	
114552	25,00	42,00	8,00	A/BS WD	FPM	114328	gearbox	DEUTZ	223 7010		01018323	
112545	105,00	130,00	15,00	AW/BS F LD	FPM	82048	crankshaft	DEUTZ	241 3332			81-23301-40
112544	45,00	65,00	10,00	AW/BS RD	FPM	95149	crankshaft	DEUTZ	241 4248		01026520	81-27390-10
80868	90,00	110,00	15,00	BS RD LA	MVQ	61099	crankshaft	DEUTZ	241 6507			
94728	90,00	110,00	15,00	BS RD LA	FPM	94728	crankshaft	DEUTZ	241 6507	331198		81-22593-20
80869	105,00	130,00	15,00	BS LD LA	MVQ	61098	crankshaft	DEUTZ	241 8366			
114630	105,00	130,00	15,00	AW/BS F LD	FPM	82048	crankshaft	DEUTZ	241 8366		12012581	
82924	25,00	40,00	10,00	AS W RD	FPM	82793	fuel injection	DEUTZ	241 9323	462977		
70548	100,00	120,00	15,00	AW/BS RD F	FPM	82047	crankshaft	DEUTZ	242 1819	756121	12012580	81-25986-20
61100	100,00	120,00	15,00	BS RD LA	MVQ	61100	crankshaft	DEUTZ	242 1819			
70549	105,00	130,00	15,00	AW/BS F LD	FPM	82048	crankshaft	DEUTZ	242 1820	756148	12012581	81-23301-40
61098	105,00	130,00	15,00	BS LD LA	MVQ	61098	crankshaft	DEUTZ	242 1820			
117146	45,00	62,00	10,00	A	MVQ	82796	crankshaft	DEUTZ	242 7066			
84196	135,00	160,00	16/13	AW/BS LD F	FPM	82799	crankshaft	DEUTZ	242 7225	830887	01016937	81-26023-00
96198	120,00	140,00	13,00	BS	NBR	94932	gearbox	DEUTZ	247 5845	105457		
82335	104,00	130,00	15/33	B SP	NBR	82334	wheel hub	DEUTZ	342 7559	044636		
84267	95,00	130,00	12/13	AW/BS RD F	FPM	82797	crankshaft	DEUTZ	414 2503	830879	01016936	81-26022-00
96575	45,00	65,00	10,00	AW/BS RD	FPM	95149	engine	DEUTZ	414 4843			
97168	45,00	72,00	10,00	BS LD LA F	FPM	97167	crankshaft	DEUTZ	414 4856			81-25887-00
82339	95,00	120,00	13/12	AW/BS RD F	FPM	82338		DEUTZ	414 6007		01016938	
84558	25,00	62,00	10,00	AW/BS	MVQ	82791	engine	DEUTZ	414 8451			
96276	25,00	45,00	10,00	AW/BS RD SF	FPM	114330	crankshaft	DEUTZ	414 8959		01029747	
81014	65,00	85,00	13/12,5	BS RD LA SP	FPM	93422	crankshaft	DEUTZ	415 0782	033457	12012095	81-21527-20
51674	115,00	140,00	16,00	BS LA LD	FPM	48305	crankshaft	DEUTZ	415 0783	033376	12012148	81-20481-20
94264	65,00	85,00	13/12,5	BS RD LA SP	FPM	93422	crankshaft	DEUTZ	415 2348	033457		
119131	115,00	140,00	16,00	BS LA LD	FPM	48305	crankshaft	DEUTZ	415 2349	033376	12012148	
82332	65,00	85,00	10,50	special	FPM	80375	crankshaft	DEUTZ	415 4144		01029745	
114523	18,00	25,00	6,00	B	NBR	21472	crankshaft	DEUTZ	415 8766		01030093	
114547	22,00	35,00	7,00	A LD	MVQ	94526	crankshaft	DEUTZ	416 0518			
109581	105,00	125,00	13,00	A/BS LD	ACM	109580	crankshaft	DEUTZ	417 5433	746310	12019078	81-31440-00
109583	55,00	75,00	10,00	A/BS RD	ACM	109582	crankshaft	DEUTZ	417 5434	746300	01032068	81-20991-00

dph-no	dim 1	dim 2	dim 3	Style	Material	dph oil seal no.	Application	Type	OEM-NO	Elring	Corteco	Reinz
118998	45,00	60,00	8,00	AS RD	ACM	109584	crankshaft	DEUTZ	417 5435			
84557	45,00	65,00	10,00	AW/BS RD	MVQ	82795	engine	DEUTZ	418 0665			
94250	45,00	62,00	10,00	A/BS F	FPM	94249	engine	DEUTZ	418 2347	462994		
114599	45,00	65,00	10,00	AW/BS RD	FPM	95149	crankshaft	DEUTZ	418 7438	763781	01026520	81-27390-10
94524	115,00	140,00	16,00	BS LA LD	FPM	48305	crankshaft	DEUTZ	423 0193	033376		
82331	115,00	140,00	16,00	BS LA LD	FPM	48305	crankshaft	DEUTZ	423 0392	033376	12012148	
112374	68,00	85,00	10,50	AS W RD	FPM/ACM	80375	BF6L913, BF6L912	DEUTZ	423 2266	033459	20020386	81-21527-30
112514	115,00	140,00	13,50	AS LD	FPM/ACM	115617	crankshaft	DEUTZ	423 2267	033377	20020387	81-20481-30
96680	130,00	150,00	13,00	AS LD FILZ	FPM/ACM	96235	crankshaft	DEUTZ	425 3333	084610	01027763	81-36001-00
114746	74,00	95,00	11,00	AW/BS RD F	FPM	110391	crankshaft 1012	DEUTZ	425 3372	084790	01027764	81-36021-00
96681	81,00	104,00	11,00	AW/BS RD V	FPM	96231	oil pump	DEUTZ	425 3373	084920	01027762	81-35999-00
114639	120,00	160,00	15,00	AS WD	NBR	110539	crankshaft	DEUTZ	430 4616		01026509	
114679	50,00	70,00	9,00	A/B WD	FPM	112583	crankshaft	DEUTZ	432 2445		01019463	
119000	136,80	165,00	13,00	KA	NBR	115632	crankshaft	DEUTZ	439 3239		12019619	
112541	70,00	90,00	10,00	AW/BS WD	FPM	114382	gearbox	DEUTZ	446 0152		12013363	
117352	45,00	55,00	7,00	B WD	NBR	93224	stub axle	EVOBUS	4 751 394 000			
117370	70,00	81,50	6,00	AW OF V	NBR	48009	wheel hub	EVOBUS	4 753 458 000			
84444	155,00	180,00	15,00	SP	FPM	84441	wheel hub	EVOBUS	4 753 622 000			
96074	70,00	81,50	6,00	AW OF V	NBR	48009	wheel hub	EVOBUS	4 753 799 000			
117356	100,00	140,00	15,00	A/BS WD W	FPM	84452	wheel hub	EVOBUS	4 753 902 000			
117354	100,00	140,00	15,00	A/BS WD W	FPM	84452	wheel hub	EVOBUS	4 753 903 000			
117353	100,00	140,00	15,00	A/BS WD W	FPM	84452	wheel hub	EVOBUS	4 753 904 000			
117355	100,00	140,00	15,00	A/BS WD W	FPM	84452	front axle	EVOBUS	4 753 907 000			
120109	20,00	35,00	7,00	BS RD	FPM	120111		Ferrari	15513			
120107	45,00	60,00	8,00	AS RD	FPM	120108		Ferrari	133628		15014894	
120103	50,00	65,00	8,00	AW/BS RD	FPM	120104		Ferrari	134714			
120105	55,00	68,00	8,00	AW/BS LD	FPM	120106		Ferrari	187140			
116809	48,00	73,3/76,50	10,00	B OF SF	NBR	117964	magnetic oil seal	FIAT	4 664 143		01034759	
97153	40,00	56,00	7,00	B RD	ACM	48470	crankshaft	FIAT	4000 0050	325007	12011455	
119284	17,00	28,00	7,00	B RD	ACM	118614	gearbox	Fiat	4000 0090		12011426	
95381	42,00	56/63,00	7,00	A RD SP	MVQ	95381	crankshaft	FIAT	4000 0320			
97150	42,00	56/63,00	7,20	B RD	ACM	112611	crankshaft	FIAT	4000 0320	440770	12011279	
97151	64,00	80,00	8,00	B RD	ACM	94587	crankshaft	FIAT	4000 0460		12011436	
97152	30,00	52,00	7,00	A/B RD	ACM	111768	crankshaft	FIAT	4000 0470	212458	12011539	
119285	17,00	28,00	7,00	B RD	ACM	118614	gearbox	Fiat	4000 1460		12011426	

dph-no	dim 1	dim 2	dim 3	Style	Material	dph oil seal no.	Application	Type	OEM-NO	Elring	Corteco	Reinz
82770	35,80	68,00	10,00	BS RD	ACM	82769	differential	FIAT	4000 2190		12011293	
111771	74,00	90,00	10,00	A/BS LD	ACM	111770	crankshaft	FIAT	4000 2740		12001483	
111783	23,00	35,00	7,00	A/BS RD	FPM	111782	crankshaft	FIAT	4000 4200	440710	12011305	81-35719-00
109073	30,00	42,00	7,00	AS RD	FPM	51727	camshaft	FIAT	4000 4240	277142	12010674	
116131	64,00	80,00	8,00	A/BS LD	MVQ	95377	crankshaft	FIAT	4000 4350			81-35876-00
119558	22,00	35,00	7,00	A/BS LD	FPM	118613	camshaft	Fiat	4000 4380		12011664	
111769	30,00	52,00	7,00	A/B RD	ACM	111768	crankshaft	FIAT	4000 4460	212458	12012411	
111384	36,00	56,00	10/13,6	A/BS LD W SP	ACM	111393	crankshaft	FIAT	4000 4620		12015267	
111791	30,00	52,00	7,00	A/BS RD	FPM	111790	crankshaft	FIAT	4000 4770		12015855	
111767	20,00	40,00	5,5/8	C RD SF	ACM	111766	crankshaft	FIAT	4000 4810		12014346	
117312	70,00	85,00	8,00	A	MVQ	94942	crankshaft	FIAT	4000 4930			
120290	40,00	56,00	7,00	BS RD	MVQ	95384	crankshaft	FIAT	4000 4950			
98269	90,00	115,00	13,00	AS LD	MVQ	98270	crankshaft	FIAT	4010 0311			81-33624-00
111778	55,00	70,00	10,00	A/BS RD SF	FPM	111777	injection pump	FIAT	4010 0320		12015093	
111776	55,00	70,00	8,00	A/BS RD SF	FPM	111775	crankshaft	FIAT	4010 0330		12015120	
111780	100,00	118,00	10,00	A/BS LD	FPM	111779	crankshaft	FIAT	4010 0340		12014831	
98531	100,00	118,00	12,00	A/BS LD	MVQ	98532	crankshaft	FIAT	4010 0341			81-33858-00
119559	40,00	55,00	7,00	AW/BS RD	FPM	118615	camshaft	Fiat	4643 4591	457220	12016528	
111774	74,00	90,00	10,00	A/BS LD	FPM	111773	crankshaft	FIAT	6080 5182	440830	12001540	
111789	31,00	41,00	7,00	A/BS RD	FPM	111788	crankshaft	FIAT	762 8850	069590	12018321	81-35882-00
109272	35,00	48,00	10,00	A/BS W RD	FPM	81442	crankshaft	FORD	1 005 301	294357		81-24292-10
97915	40,00	55,00	8,00	BS WD	ACM	97914	differential	FORD	1 005 745	539580		
96911	60,45	76,18	10,00	AS LD W	FPM	95897	crankshaft	FORD	1 048 572	693201		81-20286-00
114047	42,00	53,00	7,00	AS RD W	FPM	97916	crankshaft	FORD	1 067 029	467860	01015834	
97912	21,40	40,00	7,30	B RD	ACM	97911	crankshaft	FORD	1 075 731		12017369	
114048	38,00	52,00	7,00	AS W RD	FPM	50511	crankshaft	FORD	1 077 686			
97920	66,70	85,70	9,50	AS RD W	FPM	97919	crankshaft	FORD	1 087 556			
97925	47,60	66,70	11,30	AS W RD	AEM/PTFE	111282	crankshaft	FORD	1 087 567	516406	15015977	
112359	40,00	55,00	8,00	AS	NBR	18078	wheel hub	FORD	1 101 837		12011157	
114049	33,00	47,00	5,00	AS W RD	FPM	114098	crankshaft	FORD	1 112 945	023590	15510081	
114050	35,00	50,00	8,00	A RD SP	ACM/PTFE	114092	crankshaft	FORD	1 119 162	023630	20034565	81-35551-00
114056	40,00	55,00	6,40	AS W RD	ACM/PTFE	114093	crankshaft	FORD	1 142 359	026750	20029116	81-35554-00
114057	85,00	105,00	8,80	AS W LD	ACM/PTFE	114094	crankshaft	FORD	1 142 360	026790	20029117	81-35553-00
114058	27,00	47,00	7,00	AS W RD	ACM/PTFE	114095	camshaft	FORD	1 145 953	026740	20029115	81-35552-00
114051	30,00	50,00	7,50	AS W RD	ACM/PTFE	114096	crankshaft	FORD	1 198 045	026770	20029769	

dph-no	dim 1	dim 2	dim 3	Style	Material	dph oil seal no.	Application	Type	OEM-NO	Elring	Corteco	Reinz
114053	50,00	90,00	14,00	SP	PTFE	114097	crankshaft	FORD	1 230 867	026780		81-90014-00
33298	7,00	16,00	7,00	A	NBR	17345	crankshaft	FORD	1 463 342			
109059	79,38	95,25	11,00	AW BS LD	MVQ	80680	crankshaft	FORD	1 472 927	763713	15011263	
4062	40,00	55,00	8,00	AS	NBR	18078	wheel hub	FORD	1 482 324	039993	12011157	
33297	18,00	35,00	10,00	A	NBR	17489	injection pump	FORD	1 491 853		12010819	
94512	44,45	60,33	9,50	AS	NBR	94511	wheel hub	FORD	1 536 229		12012128	
4058	36,51	52,58	7,93	AS	NBR	45544	wheel hub	FORD	1 572 045		12011150	
82482	42,00	60,00	8,00	A W RD	ACM	59256	crankshaft	FORD	1 576 424			81-27333-00
33296	40,00	55,00	8,00	AS	NBR	18078	wheel hub	FORD	1 579 665	039993	12011157	
97910	7,00	16,00	6,00	AS	NBR	97909		FORD	1 579 860			
93623	36,51	52,48	8,00	AS W	MVQ	80634	crankshaft	FORD	1 614 762	586730	15012245	81-23056-00
93703	79,38	95,25	11,00	AW/BS LD	MVQ	80680	crankshaft	FORD	1 614 763	763713	15011263	
93704	79,38	95,25	11,00	AW/BS LD	MVQ	80680	crankshaft	FORD	1 614 764	763713	15011263	
37641	42,00	56,00	7,00	AS RD W	MVQ	37639	camshaft	FORD	1 614 994		15011250	81-51109-20
96238	35,00	50,00	7,00	A W RD	MVQ	59255	crankshaft	FORD	1 614 995			
96239	88,00	108,00	11,10	AW/BS LD	MVQ	80679	crankshaft	FORD	1 614 996		15011269	
37643	60,35	76,18	11,00	AW/BS LD	MVQ	37642	crankshaft	FORD	1 634 647			
95623	60,35	76,18	11,00	AW/BS LD	FPM	95623	crankshaft	FORD	1 634 647			
96103	50,00	63,00	8,3/13	BS SP	NBR	94652	wheel hub	FORD	1 637 279			
112361	55,00	70,00	6/10,5	BS SP	NBR	112368	wheel hub	FORD	1 637 280	587036	12011181	
112360	50,00	65,00	9,75/14	BS SP	NBR	112367	wheel hub	FORD	1 637 281		12011175	
80637	79,38	95,25	11,00	AW/BS LD	MVQ	80680	crankshaft	FORD	1 641 893			
80636	79,38	95,25	11,00	AW/BS LD	FPM	80636	crankshaft	FORD	1 641 893	763713	12015675	
96246	35,00	50,00	7,00	A/B RD	FPM	50167	crankshaft	FORD	1 663 814		15510079	
109036	88,00	108,00	11,10	AW/BS LD	FPM	80639	crankshaft	FORD	1 663 815		15510078	
97917	42,00	53,00	7,00	AS RD W	FPM	97916	crankshaft	FORD	1 663 822	467860	01015834	81-33581-00
96247	42,00	56,00	7,00	AS W RD	FPM	82475	differential	FORD	1 669 254	757497	12014404	
119096	122,00	141,00	12,00	AS	MVQ	95376	crankshaft	FORD	3 905 794			
112363	42,00	62,00	12,00	AW/BS RD	FPM	15245	wheel hub	FORD	6 042 618			
4073	55,00	70,00	6/10,25	BS SP	NBR	112368	rear axle	FORD	6 043 882	587036	12011181	
112362	48,00	65,00	12,70	B LA SP	NBR	112369	wheel hub, front axle	FORD	6 048 486			
81088	42,00	56,00	7,00	AS RD W	MVQ	37639	camshaft	FORD	6 078 801		15011250	81-51109-20
109062	48,00	65,00	10,00	B	NBR	81637	gearbox	FORD	6 109 963		12011331	
116379	79,38	95,25	11,00	AW/BS LD	FPM	80636	crankshaft	FORD	6 112 201		12015675	
37648	34,93	49,96	8,00	AS W WD	MVQ	37652	crankshaft	FORD	6 123 792	586757		81-22700-10

									OEM-NO			
dph-no	dim 1	dim 2	dim 3	Style	Material	dph oil seal no.	Application	Type	OEM-NO	Elring	Corteco	Reinz
81087	88,00	108,00	11,10	AW BS LD	MVQ	80679	crankshaft	FORD	6 126 179	750476	15011269	
80639	88,00	108,00	11,10	AW/BS LD	FPM	80639	crankshaft	FORD	6 126 179			81-25452-10
81138	28,00	38,00	7,00	AS RD	FPM	81139		FORD	6 135 090	562653	12013949	81-26268-00
82477	42,00	58,00	10,00	AS RD	FPM	82478	crankshaft	FORD	6 135 093			
97931	62,00	80,00	12,00	BS RD LA	FPM	97930		FORD	6 135 100	562629	12011475	81-23418-10
80630	36,51	52,48	8,00	AS W	MVQ	80634	crankshaft	FORD	6 139 049	586730	15012245	81-23056-00
48722	54,51	76,09	9,5/15,4	AS RD SF	NBR	97926	wheel hub	FORD	6 142 760		12012570	
97905	57,15	81,86	7/14	AS SF	NBR	97904	wheel hub	FORD	6 143 628		12017122	
97903	69,60	99,97	20,7/12,7	AS WD SF	NBR	97902	wheel hub	FORD	6 143 629		12012569	
97907	28,00	40,00	7/8,5	AS RD	ACM	97906	gearbox	FORD	6 152 663		01031967	
80632	42,00	56,00	7,00	AS W RD	FPM	82475	differential	FORD	6 165 498	757497	12014404	81-51109-30
84269	35,00	50,00	7,00	A/B RD	FPM	50167	crankshaft	FORD	6 165 499	757292		81-25451-10
80635	35,00	50,00	7,00	A W RD	MVQ	59255	crankshaft	FORD	6 165 500			
80631	88,00	108,00	11,10	AW/BS LD	FPM	80639	crankshaft	FORD	6 165 502	750476	12014402	
80679	88,00	108,00	11,10	AW/BS LD	MVQ	80679	crankshaft	FORD	6 165 502			
32333	66,67	89,30	10,00	AS W RD	FPM	32072	crankshaft	FORD	6 175 915		12015552	
93931	66,67	89,33	9,50	AS W RD	MVQ	93731	crankshaft	FORD	6 175 915			
116665	79,00	99,00	9,60	AS LD SP	FPM	97924	crankshaft	FORD	6 182 960			
97929	27,00	42,00	6,00	AS RD W	ACM	97928	crankshaft	FORD	6 184 211		12015750	
48725	49,00	62,6/77,50	9/13	BO	NBR	117061	gearbox	FORD	6 562 502			
51223	50,00	65,00	10,00	BS	NBR	44507	wheel hub, rear axle	FORD	6 594 477			
48720	62,00	78,00	9/15	BS SP	NBR	48719		FORD	6 612 972			
95898	60,45	76,18	10,00	AS LD W	FPM	95897	crankshaft	FORD	6 803 967	693201	12015546	81-20286-00
119030	18,50	42,00	3,60	A OF	NBR	119029		FORD	FOCC3D527AA		19025707	
95633	107,95	152,40	28,57	SP	NBR	95633	axle	FRUEHAUF	AGA0564001			
82165	107,95	152,40	19,46	SP	NBR	82165	ABS axle	FRUEHAUF	M100500			
96979	95,30	114,29	11,88	BS WD LA	FPM	96979	gearbox	FULLER	K2256			
93822	107,95	146,05	12,70	SP	NBR	93821		Hendrickson	501118			
93825	125,41	160,33	12,70	SP	NBR	93824	800 series axle	Hendrickson	502776			
110728	10,00	15,00	3,00	B OF	NBR	47952	front axle	IVECO	112 2949		01002259	
117396	35,00	47,00	7,00	AS	NBR	17907	crankshaft	IVECO	126 8104		12011143	
110729	48,00	65,00	10,00	B	NBR	81637	gearbox	IVECO	127 4257		12011331	
112551	17,00	28,00	7,00	AS	NBR	17448	crankshaft	IVECO	128 8064		12011112	
117774	38,00	52,00	7,00	B	NBR	20004	crankshaft	IVECO	129 0380		01025734	
110730	95,30	114,29	11,88	BS WD LA	FPM	96979	crankshaft	IVECO	190 5085		12012235	

dph-no	dim 1	dim 2	dim 3	Style	Material	dph oil seal no.	Application	Type	OEM-NO	Elring	Corteco	Reinz
111635	150,00	170,00	15,00	CS	NBR	61249	crankshaft	IVECO	244 2744		12011423	
94513	120,00	140,00	13,00	BS	NBR	94932	crankshaft	IVECO	247 5845	105457	12012064	
111636	110,00	130,00	13,00	CS	NBR	111637	crankshaft	IVECO	247 5900		12012065	
114444	117,48	152,36	22,00	SP KA	NBR	113977	wheel hub	IVECO	247 5977		12018944	
93700	85,00	110,00	12,00	BS	NBR	42696	crankshaft	IVECO	247 7868		12011360	
114693	55,00	68,00	12,00	B Duo	NBR	93695	crankshaft	IVECO	247 8478		12011383	
82963	120,65	160,35	30,56	SP	NBR	93222	crankshaft	IVECO	247 9330			
114445	111,12	146,05	24,21	SP	NBR	84679	axle	IVECO	247 9949			
110731	48,00	65,00	10,00	B	NBR	81637	gearbox	IVECO	298 0071		12011331	
117395	25,00	40,00	7,00	AS	NBR	17615	crankshaft	IVECO	298 2310		12011123	
114879	150,00	170,00	12,00	AW BS	NBR	114876	crankshaft	IVECO	299 7032			
117397	45,00	65,00	10,00	AS	NBR	18234	crankshaft	IVECO	3 345 907		12011168	
114509	110,00	140,00	14,00	A SP	NBR	114453	crankshaft	IVECO	3 345 908			
114482	135,00	160,00	13,00	CS	NBR	114433	crankshaft	IVECO	3 414 237			
110739	80,00	100,00	10,00	A green	NBR	4306	front-/rear axle	IVECO	3850 5699	546038	12011026	
114752	75,00	100,00	10,00	A	NBR	84535	wheel hub	IVECO	3851 0549	530107	12011021	
117416	80,00	110,00	12,00	A	NBR	18698	crankshaft	IVECO	3851 2262		12011030	
117399	70,00	100,00	12,00	A	NBR	84533	crankshaft	IVECO	3851 4100	325473	12011017	
114588	42,00	65,00	12/8	AW/BS RD	ACM	82398	crankshaft	IVECO	4000 0010		12011460	
112546	40,00	56,00	7,00	B RD	ACM	48470	crankshaft	IVECO	4000 0050	325007	12011455	
119097	62,00	80,00	10,00	BS LD	ACM	81351	crankshaft	IVECO	4000 0280		12011433	
83894	62,00	80,00	10,00	BS LD	ACM	81351	crankshaft	IVECO	4000 0283	028436	12011433	
112550	45,00	65,00	10,00	B	NBR	51487	gearbox	IVECO	4000 0370		12001744	
111638	145,00	170,00	13,00	BS blue	NBR	18949	wheel hub	IVECO	4000 0480		12011373	
83893	55,00	80,00	10,00	BS	NBR	50343	gearbox	IVECO	4000 0520			
83895	42,00	62,00	10,00	B RD	ACM	81352	crankshaft	IVECO	4000 0583		12011459	
111639	180,00	200,00	15,00	BS green	NBR	70805	crankshaft	IVECO	4000 0690		12011379	
114612	95,00	120,00	13,00	BS LD	FPM	82399	crankshaft	IVECO	4000 0720	071570	12011314	
117407	100,00	120,00	10,00	BS SF	NBR	111681	crankshaft	IVECO	4000 0760		12011363	
114636	117,47	142,87	12,70	CS	NBR	81339	wheel hub	IVECO	4000 1010		12011417	
114510	118,00	136,00	13,00	B	NBR	18895	crankshaft	IVECO	4000 1060		12011347	
114662	160,00	185,00	13,00	BS	NBR	18967	crankshaft	IVECO	4000 1650		12011376	
118921	160,00	185,00	13,00	BS	NBR	18967	crankshaft	IVECO	4000 1653		12011376	
114574	38,00	50,00	7,00	A	NBR	70214	crankshaft	IVECO	4000 1820		12010923	
117400	75,00	100,00	13,00	CS	NBR	97437	gearbox	IVECO	4000 1830		12011411	

									OEM-NO			
dph-no	dim 1	dim 2	dim 3	Style	Material	dph oil seal no.	Application	Type	OEM-NO	Elring	Corteco	Reinz
83897	75,00	100,00	13,00	CS	NBR	97437	gearbox	IVECO	4000 1880		12011411	
111642	90,00	110,00	13,00	CS	NBR	18763	rear axle	IVECO	4000 1900		12011412	
117409	100,00	130,00	13,00	CS	NBR	81335	wheel hub	IVECO	4000 1910		12011415	
82366	100,00	130,00	13,00	CS	NBR	81335	wheel hub	IVECO	4000 1913		12011415	
81569	117,47	142,87	12,70	CS	NBR	81339	wheel hub	IVECO	4000 1920		12011417	
117411	125,00	150,00	13,00	CS	NBR	81334	crankshaft	IVECO	4000 1930		12011419	
84199	125,00	150,00	13,00	CS	NBR	81334	crankshaft	IVECO	4000 1933	022560	12011419	
112548	60,00	85,00	10,00	B	NBR	47466	gearbox	IVECO	4000 2020		12011334	
93846	90,00	115,00	13,00	A/BS LD W	FPM	81347	crankshaft	IVECO	4000 2631			
114483	105,00	136,00	13,00	CS	NBR	114427	wheel hub	IVECO	4000 2851		12011416	
119098	50,00	81,00	13,00	BS	ACM	81345	differential	IVECO	4000 3710		12011432	
83899	50,00	81,00	13,00	BS	ACM	81345	differential	IVECO	4000 3713		12011432	
95055	180,00	200,00	12,00	BS	NBR	82893	crankshaft	IVECO	4000 3720	348376	12011378	
95056	180,00	200,00	12,00	A/B W WD	FPM	81338	rear axle	IVECO	4000 3730	018670	12011326	
112552	114,00	135,00	13,00	AW BS LD	FPM	116149	crankshaft	IVECO	4000 3800		12011318	
114484	95,00	114,00	14,00	C WD	ACM	114439	wheel hub	IVECO	4010 0093		12001579	
114507	140,00	160,00	14,00	C WD	ACM	114452	crankshaft	IVECO	4010 0103		12011593	
117410	100,00	130,00	14,00	C WD	ACM	114451	crankshaft	IVECO	4010 0110		12001580	
114506	100,00	130,00	14,00	C WD	ACM	114451	crankshaft	IVECO	4010 0113		12001580	
119099	90,00	115,00	13,00	A/BS LD W	FPM	81347	crankshaft	IVECO	4010 0310		12011304	
81570	90,00	115,00	13,00	A/BS LD W	FPM	81347	crankshaft	IVECO	4010 0313		12011304	
114877	150,00	170,00	12,00	AW/BS	NBR	114876	crankshaft	IVECO	4010 0393			
111643	180,00	200,00	12,00	BS	NBR	82893	crankshaft	IVECO	4010 0440		12012049	
109745	180,00	200,00	12,00	BS	NBR	82893	crankshaft	IVECO	4010 0443		12012049	
114623	100,00	130,00	12,00	A/CS WD W	ACM	81353	crankshaft	IVECO	4010 0460		12014422	
117408	100,00	130,00	12,00	A/CS WD W	ACM	81353	crankshaft	IVECO	4010 0463		12014422	
111641	85,00	110,00	12,00	A/CS W WD	ACM	83908	wheel hub	IVECO	4010 0470		12014599	
83909	85,00	110,00	12,00	A/CS W WD	ACM	83908	wheel hub	IVECO	4010 0473			
119100	70,00	90,00	12,00	A/CS WD W	ACM	81631	wheel hub	IVECO	4010 0480		12014289	
81571	70,00	90,00	12,00	A/CS WD W	ACM	81631	wheel hub	IVECO	4010 0483		12014289	
114757	78,00	100,00	10,00	AW/BS LD	FPM	114390	crankshaft	IVECO	4010 0490		12013860	
119101	134,00	152,00	14,00	A/CS WD W	ACM	81344	wheel hub	IVECO	4010 0650		12014598	
81572	134,00	152,00	14,00	A/CS WD W	ACM	81344	wheel hub	IVECO	4010 0653		12014598	
119102	140,00	170,00	14,00	A/CS WD W	ACM	81343	crankshaft	IVECO	4010 0660		12014601	
81573	140,00	170,00	14,00	A/CS WD W	ACM	81343	crankshaft	IVECO	4010 0663		12014601	

dph-no	dim 1	dim 2	dim 3	Style	Material	dph oil seal no.	Application	Type	OEM-NO	Elring	Corteco	Reinz
117414	180,00	200,00	12,00	A/B W WD	FPM	81338	wheel hub	IVECO	4010 0670		12014190	
84200	180,00	200,00	12,00	A/B W WD	FPM	81338	wheel hub	IVECO	4010 0673		12014190	
114561	30,00	47,00	8,00	BS	ACM	81348	crankshaft	IVECO	4010 0790		12012768	
118920	30,00	47,00	8,00	BS	ACM	81348	crankshaft	IVECO	4010 0791		12012768	
114485	80,00	100,00	10,00	AW/BS WD	FPM	47995	differential	IVECO	4010 0860		12015770	
112610	42,00	65,00	10,00	AW BS RD	FPM	112609	crankshaft	IVECO	4010 0870		12016489	
117393	25,00	35,00	7,00	B	NBR	4378	gearbox	IVECO	4010 1080		12014616	
114486	150,00	170,00	16,00	AW/BS WD	FPM	114426	crankshaft	IVECO	4010 1093		12015745	
114487	120,00	140,00	14,00	AW/BS WD	FPM	114431	crankshaft	IVECO	4010 1103		12014302	
114488	128,00	148,00	12,00	AW/BS WD	FPM	114430	crankshaft	IVECO	4010 1113		12012815	
114489	48,00	62,00	10,00	AW/BS WD	FPM	114440	crankshaft	IVECO	4010 1353		12016835	
114644	125,00	150,00	15,00	AS/BW LD	FPM	51252	crankshaft	IVECO	4010 1400		12015746	81-24476-20
119103	140,00	165,00	15,00	A/BS LD W	FPM	81349	crankshaft	IVECO	4010 1430		12015780	
81574	140,00	165,00	15,00	A/BS LD W	FPM	81349	crankshaft	IVECO	4010 1433		12015780	
114742	70,00	100,00	13,00	A/CS WD W	ACM	81355	wheel hub	IVECO	4010 1700		12014381	
117415	180,00	200,00	17,00	A/BS WD	FPM	83906	crankshaft	IVECO	4010 1730		12015265	
83907	180,00	200,00	17,00	AW/BS WD	FPM	83906	crankshaft	IVECO	4010 1733		12015265	
119104	85,00	110,00	14,00	A/CS WD W	FPM	81350	crankshaft	IVECO	4010 2050		12015544	
83900	85,00	110,00	14,00	A/CS WD W	FPM	81350	crankshaft	IVECO	4010 2053		12015544	
114514	128,00	144/152,30	11/25	SP	FPM	114458	wheel hub	IVECO	4010 2103		12015506	
119105	95,00	130,00	16,00	KA SP	FPM/ACM	93221	crankshaft	IVECO	4010 2140		12015509	
82965	95,00	130,00	16,00	KA SP	FPM/ACM	93221	crankshaft	IVECO	4010 2143	454000	12015509	
83901	60,00	90,00	14/16,30	SP	FPM/ACM	81354	differential	IVECO	4010 2263		12015791	
119107	70,00	90,00	13,5/14,50	SP	FPM	95465	crankshaft	IVECO	4010 2270		12015793	
94797	70,00	90,00	13,5/14,50	SP	FPM	95465	crankshaft	IVECO	4010 2273	013930	12015793	
118923	70,00	100,00	13,5/15,00	KS SP	FPM	114864	wheel hub	IVECO	4010 2280		12014381	
114743	70,00	100,00	13,5/15,00	KS SP	FPM	114864	wheel hub	IVECO	4010 2283		12014381	
119109	65,00	90,00	13/14,50	KA/KB SP	FPM/ACM	109807	crankshaft	IVECO	4010 2290		12015928	
109804	65,00	90,00	13/14,50	KA/KB SP	FPM/ACM	109807	crankshaft	IVECO	4010 2293		12015928	
111376	80,00	110/115,00	10/13	KA	FPM	111389	crankshaft	IVECO	4010 2301		12033893	
119110	114,10	152/159,30	14,00	KA	FPM	111390	crankshaft	IVECO	4010 2320		12017353	
111377	114,10	152/159,30	14,00	KA	FPM	111390	crankshaft	IVECO	4010 2321		12017353	
119106	60,00	90,00	14/16,30	SP	FPM/ACM	81354	differential	IVECO	4010 2660		12015791	
114856	179,00	200,00	15,5/16,5	KA	FPM	114855	wheel hub	IVECO	4010 2940	456130	12017354	
118924	179,00	200,00	15,5/16,5	KA	FPM	114855	wheel hub	IVECO	4010 2943	456130	12017354	

									OEM-NO			
dph-no	dim 1	dim 2	dim 3	Style	Material	dph oil seal no.	Application	Type	OEM-NO	Elring	Corteco	Reinz
96199	35,00	42,00	5,50	BS OF	NBR	96201		IVECO	4200 1982			
112540	115,00	140,00	13,00	A BS blue	NBR	48022	rear axle	IVECO	4203 1150		12015887	
98440	180,00	200,00	12,00	BS	NBR	82893	crankshaft	IVECO	4203 7581	348376	12011378	
113032	180,00	200,00	12,00	B WD	FPM	113031	crankshaft	IVECO	4203 7582	018670	12011326	
93698	65,00	80,00	8,00	BS	NBR	43194		IVECO	4206 1445			
115205	150,00	170,00	12,00	AW/BS	NBR	114876		IVECO	4206 2983			
115206	150,00	170,00	16,00	AW BS WD	FPM	114426		IVECO	4206 2984			
117667	180,00	200,00	13,50	KA	NBR	117705	crankshaft	IVECO	4212 7773		12019601	
112542	85,00	105,00	10,00	B LD	FPM	4047	gearbox	IVECO	4248 5827	033464	12013757	
112543	55,00	80,00	10,00	BS	NBR	50343	gearbox	IVECO	4248 6609			
114711	60,00	85,00	12,00	B RD	FPM	47991	gearbox	IVECO	4248 7132		12012578	
111640	48,00	65,00	10,00	B	NBR	81637	gearbox	IVECO	4248 7485		12011331	
114617	95,30	114,29	11,88	BS WD LA	FPM	96979	gearbox	IVECO	4249 0447		12012235	
117398	60,00	75,00	8,00	A	NBR	18484	crankshaft	IVECO	4459 074		12010997	
81575	140,00	160/190,00	14/28	special	NBR	81342	rear axle	IVECO	4460 212			
117412	140,00	160,00	13,00	BS	NBR	70576	rear axle	IVECO	4560 719		12011349	
110732	160,00	185,00	13,00	BS	NBR	18967	crankshaft	IVECO	4580 400		12011376	
110734	30,00	55,00	10,00	A	NBR	17780	crankshaft	IVECO	4587 996		12010889	
117402	80,00	110,00	13,00	A	NBR	18701	gearbox	IVECO	540 727		12011031	
93699	70,00	90,00	12,00	A/CS WD W	ACM	81631		IVECO	7010 0303			
110724	30,00	55,00	10,00	A	NBR	17780	crankshaft	IVECO	724 579		12010889	
110725	30,00	55,00	10,00	A	NBR	17780	crankshaft	IVECO	734 128		12010889	
117394	25,00	40,00	7,00	AS	NBR	17615	steering	IVECO	767 775	038164	12011123	
113877	47,63	65,07	6,35	A WD SF	FPM	114111	crankshaft	IVECO	798 0285		12010744	
110735	95,30	114,29	11,88	BS WD LA	FPM	96979	gearbox	IVECO	798 0661		12012235	
110736	150,00	180,00	15,00	CS	NBR	94056		IVECO	812 3442			
110737	30,00	42,00	6/6,8	BABSL WD	NBR	84542	injection pump	IVECO	819 4388		11014231	
110726	75,00	100,00	10,00	A	NBR	84535	gearbox	IVECO	843 075		12011021	
110727	70,00	100,00	12,00	A	NBR	84533	engine various	IVECO	851 101	325473	12011017	
110738	150,00	180,00	13	A	NBR	6713	front-/rear axle	IVECO	852 7970	109657	12011091	
117406	95,00	110,00	10	B WD	NBR	113957	wheel hub	IVECO	8601 4686		07013389	
114754	75,00	100,00	13,00	CS	NBR	97437	gearbox	IVECO	883 6666		12011411	
84449	135,00	170,00	18,00	SP	PTFE/NBR	97004		KB	4 753 571 0000			
84453	100,00	140,00	15,00	A/BS WD W	FPM	84452	front axle	KB	4 753 656 0000			
119279	28,00	40,00	7,00	A	NBR	17697		KHD	115 1122			

dph-no	dim 1	dim 2	dim 3	Style	Material	dph oil seal no.	Application	Type	OEM-NO	Elring	Corteco	Reinz
119280	85,00	100,00	12,00	AS	NBR	44179		KHD	116 0856			
118601	83,00	100,00	9,00	AS LD	MVQ	110016		KIA	0K201 11 312			81-53404-00
48471	40,00	56,00	7,00	B RD	ACM	48470	crankshaft	LADA	2101 100 5034		12011455	81-21087-10
48473	70,00	90,00	10,00	BS LD	MVQ	48472	crankshaft	LADA	2101 100 5160		12011438	81-15287-10
82439	28,00	42,00	7,00	AS W RD	MVQ	48466	crankshaft	LADA	2108 100 5040			
48469	80,00	100,00	10,00	AS W LD	MVQ	48468	crankshaft	LADA	2108 100 5160	546941		
114590	44,00	60,00	10,00	AS W RD	FPM	80654	crankshaft	LANCIA	46108224		12014608	
114520	17,00	28,00	7,00	A	NBR	17447	crankshaft	MAN	06 56260 1106	050300	12010807	
114548	22,00	40,00	10,00	A	NBR	17567	crankshaft	MAN	06 56260 1408	037850	12010838	
114559	30,00	40,00	7,00	A	NBR	113776	crankshaft	MAN	06 56260 1911	201006	12010879	
114560	30,00	42,00	7,00	A	NBR	17728	crankshaft	MAN	06 56260 1912	203408	12010880	
117302	14,00	24,00	7,00	B	NBR	19033		MAN	06 56261 0804	037109		
35089	18,00	30,00	7,00	B	NBR	19149		MAN	06 56261 1207			
117303	25,00	35,00	7,00	B	NBR	4378	gearbox	MAN	06 56261 1609	038083	12014616	81-35123-00
35090	25,00	52,00	7,00	B	NBR	17653	crankshaft	MAN	06 56261 1615	038385	01002458	
4716	30,00	40,00	7,00	B blue	NBR	6451	crankshaft	MAN	06 56261 1911	038814		
35091	10,00	19,00	7,00	B	NBR	17357		MAN	06 56269 0001			
114554	27,00	37,00	7,00	A	NBR	17672	crankshaft	MAN	06 56269 0458		12010870	
114516	10,00	15,00	3,00	B OF	NBR	47952	front axle	MAN	06 56269 0479	010804	01002259	
114517	10,00	15,00	3,00	B OF	NBR	47952	front axle	MAN	06 56269 0527	010804	01002259	
114524	20,00	28,00	6,00	A	NBR	19212	crankshaft	MAN	06 56269 0578		12001989	
82925	40,00	55,00	7,00	B	NBR	18076	crankshaft	MAN	06 56271 0404		12010932	
82926	40,00	62,00	7,00	B	NBR	20011		MAN	06 56271 0406			
35092	50,00	65,00	8,00	B	NBR	18316	wheel hub	MAN	06 56271 0807	041114		
82860	65,00	85,00	10,00	B	NBR	18567		MAN	06 56271 1613			
82927	65,00	100,00	10,00	B	NBR	18589		MAN	06 56271 1616			
35093	75,00	95,00	10,00	B	NBR	18656		MAN	06 56271 2015			
84398	70,00	90,00	10,00	B	NBR	18612	gearbox	MAN	06 56271 3814			
35094	52,00	72,00	12,00	BS	NBR	35095	differential	MAN	06 56272 0047	091901		
35096	58,00	80,00	10,00	C	NBR	18474		MAN	06 56272 1212			
35097	60,00	80,00	10,00	C green	NBR	51483	front axle	MAN	06 56272 1312	041513		
35098	60,00	85,00	10,00	B	NBR	47466	gearbox	MAN	06 56272 1313		12011334	
35099	65,00	85,00	12,00	C	NBR	18571		MAN	06 56272 1613			
35100	65,00	90,00	12,00	C	NBR	18578		MAN	06 56272 1614			
35101	68,00	90,00	12,00	C	NBR	24236		MAN	06 56272 1714			

dph-no	dim 1	dim 2	dim 3	Style	Material	dph oil seal no.	Application	Type	OEM-NO	Elring	Corteco	Reinz
35102	70,00	90,00	12,00	C	NBR	18616	wheel hub	MAN	06 56272 1814		12011410	
35103	70,00	100,00	12,00	C	NBR	18630	crankshaft	MAN	06 56272 1816			
35106	75,00	100,00	12,00	C	NBR	18668		MAN	06 56272 2016			
84399	75,00	100,00	12,00	C	FPM	84438	rear axle	MAN	06 56272 8016			
35107	68,00	90,00	10,00	C	NBR	20037		MAN	06 56274 1714			
114600	45,00	65,00	10,00	B	NBR	51487	gearbox	MAN	06 56279 0003	040843	12011509	
35108	42,00	65,00	10,00	C	NBR	18183		MAN	06 56279 0014			
35109	70,00	90,00	13,00	C	NBR	18619		MAN	06 56279 0019	042161		
82931	57,00	75,00	7,5/6	AS K	NBR	48052	front axle	MAN	06 56279 0025	008664	01020674	
35110	72,00	105,00	13,00	BS green	NBR	4767	front&rear axle	MAN	06 56279 0028	008559	12012573	
80537	50,00	70,00	8,00	C	NBR	61496	front axle	MAN	06 56279 0029	108642	01020675	
69796	50,00	70,00	10/14	BS2	NBR	59295	front axle	MAN	06 56279 0031	008028	01016768	
114585	42,00	62,00	10,00	A	NBR	18175	wheel hub	MAN	06 56279 0035	040355	12010946	
114595	45,00	62,00	10,00	A	NBR	18223	crankshaft	MAN	06 56279 0039	367206	12010954	
35112	46,00	62,00	12,00	C	NBR	35113		MAN	06 56279 0041			
35115	48,00	65,00	10,00	B green	NBR	81637	gearbox	MAN	06 56279 0042	040991	12011331	
35116	52,00	72,00	12,00	BS	NBR	35095	differential	MAN	06 56279 0047	091901		
114695	55,00	72,00	10,00	BS	NBR	45537		MAN	06 56279 0049			
35117	55,00	80,00	13,00	B	NBR	18440		MAN	06 56279 0050			
35118	60,00	80,00	13,00	B	NBR	18499		MAN	06 56279 0054			
35119	60,00	80,00	10,00	BS	NBR	35120		MAN	06 56279 0055			
35121	62,00	75,00	10,00	B	NBR	35122	rear axle	MAN	06 56279 0057			
35123	62,00	85,00	10,00	C	NBR	18534		MAN	06 56279 0059			
114739	70,00	90,00	10/14	SP	NBR	114383	crankshaft	MAN	06 56279 0064		01029728	
35126	70,00	95,00	13,00	C	NBR	18623		MAN	06 56279 0066			
46636	72,00	105,00	13,00	C WD	FPM	48048	front axle	MAN	06 56279 0073	008745	12014743	
112453	50,00	70,00	10/14	BS2	NBR	59295	front axle	MAN	06 56279 0080	008028		
114672	48,00	75,00	8,00	B RD	FPM	4545	gearbox	MAN	06 56279 0084	033472	12011307	
35127	48,00	62,00	10,00	B	NBR	18282		MAN	06 56279 0087			
96525	42,00	55,00	9,00	B	FPM	48010	front axle	MAN	06 56279 0095			
80281	42,00	58,00	7,00	BS	NBR	37347	rear axle	MAN	06 56279 0114	010197		
35264	42,00	58,00	7,00	BS	NBR	37347	rear axle	MAN	06 56279 0133	010197		
117329	55,00	80,00	10,00	BS	NBR	50343	gearbox	MAN	06 56279 0136	446602		
117369	50,00	65,00	10,00	B	NBR	116340	wheel hub	MAN	06 56279 0138	041114	01020676	81-35124-00
96080	62,00	80,00	10,00	C	NBR	51708	front axle	MAN	06 56279 0147	484300	12003292	

dph-no	dim 1	dim 2	dim 3	Style	Material	dph oil seal no.	Application	Type	OEM-NO	Elring	Corteco	Reinz
96079	62,00	80,00	10,00	B	FPM	32721		MAN	06 56279 0148			
69190	64,00	80,00	13,00	AS blue	NBR	61497	front axle	MAN	06 56279 0181	008591	01016769	
48119	75,00	95,00	12,50	BS	NBR	50347	camshaft	MAN	06 56279 0183	008370	01019460	
80282	68,00	90,00	12,50	BS	NBR	50346	rear axle	MAN	06 56279 0184	008303	01026650	
114700	55,00	80,00	10/12	AS	NBR	80530	crankshaft	MAN	06 56279 0194			
114731	68,00	90,00	10/9,50	B WD	FPM	47989	rear axle	MAN	06 56279 0209	008508		
114734	70,00	90,00	10,00	AW/BS WD	FPM	114382	gearbox	MAN	06 56279 0211		12013363	
81190	75,00	95,00	10/9,50	B WD	FPM	4380	transfer gearbox	MAN	06 56279 0215	327363	01019459	
104429	60,00	80,00	10,00	CS	NBR	104422		MAN	06 56279 0235			
94303	70,00	90,00	12,00	C	FPM	94302	crankshaft	MAN	06 56279 0236		01012087	
114852	131,00	75,40	16,00	SP	NBR	114851		MAN	06 56279 0259			
94804	42,00	52,00	5,00	B OF	FPM	97353	camshaft	MAN	06 56279 0262		01030090	
61341	50,00	58,00	4,00	BO	NBR	22997	stub axle	MAN	06 56279 0273			
114727	66,67	115,92/125,40	11,9/18,2	BS WD SF	FPM	114372	crankshaft	MAN	06 56279 0275		01016915	
93150	45,00	52,00	4,00	BO	NBR	48498	crankshaft	MAN	06 56279 0278		01025733	
95831	37,50	45,00	4,00	BO	NBR	95827	stub axle	MAN	06 56279 0284			
95832	42,00	49,00	4,00	BO	NBR	95828	stub axle	MAN	06 56279 0289			
117357	35,00	42,00	4,00	BO	NBR	95957	front axle	MAN	06 56279 0290			
117359	35,00	42,00	4,00	BO	NBR	95957	front axle	MAN	06 56279 0291			
117358	35,00	42,00	4,00	BO	NBR	95957	front axle	MAN	06 56279 0292			
81191	42,00	55,00	9,00	B	FPM	48010	front axle	MAN	06 56279 0297		01017009	
84546	42,00	58,00	7,00	B	NBR	19600	camshaft	MAN	06 56279 0310			
69160	72,00	105,00	13,00	BS	NBR	4767	front&rear axle	MAN	06 56279 0312	008559	12012573	
113669	76,00	94,00	9,00	A/B	NBR	113668	crankshaft	MAN	06 56279 0315		01019465	
93350	68,00	90,00	10/9,50	B WD	FPM	47989	differential	MAN	06 56279 0323		12012575	
61407	68,00	90,00	10,00	BS	NBR	95922	differential	MAN	06 56279 0327		01020465	
114749	75,00	95,00	10,00	A/B WD	FPM	47938	differential	MAN	06 56279 0331	104310	01016962	
69845	75,00	95,00	9,5/10	A/BS	NBR	114110	differential	MAN	06 56279 0335	104320	01020042	
113838	113,00	140,00	12,00	A/B	ACM	113837	wheel hub	MAN	06 56279 0341			
81590	42,00	58,00	7,00	BS	NBR	37347	brake cam shaft	MAN	06 56279 0350			
114692	55,00	68,00	8,00	A/BS RD	FPM	97403	camshaft	MAN	06 56279 0352		12015711	
95833	50,00	58,00	4,00	BO	NBR	22997	stub axle	MAN	06 56279 0353		01012190	
117300	72,00	105,00	13,00	C WD	FPM	48048	differential	MAN	06 56279 0366		12014743	
33649	100,00	130,00	13,00	B	NBR	19869	front-/rear axle	MAN	06 56281 0605	519243		81-35151-00
35128	115,00	140,00	15,00	C	NBR	18888		MAN	06 56282 0906			

dph-no	dim 1	dim 2	dim 3	Style	Material	dph oil seal no.	Application	Type	OEM-NO	Elring	Corteco	Reinz
109419	120,00	150,00	15/12	CS	NBR	48002	front axle	MAN	06 56282 1007			
114653	140,00	170,00	14,00	A/CS WD W	ACM	81343	crankshaft	MAN	06 56282 1409		12001584	
35129	170,00	200,00	15,00	C	NBR	18979		MAN	06 56282 1813			
35130	190,00	220,00	15,00	C	NBR	93619	axle	MAN	06 56282 2015			
114621	100,00	125,00	13/10	C	NBR	50810	rear axle	MAN	06 56289 0009		12011401	81-35096-00
35131	165,00	190,00	13,00	A blue	NBR	4374	fron-/rear axle	MAN	06 56289 0013		12011096	
34633	80,00	100,00	12,00	BS blue	NBR	50348	rear axle	MAN	06 56289 0022	008354		
34647	145,00	175,00	14,00	BS blue	NBR	4376	rear axle	MAN	06 56289 0027		12011374	
117308	80,00	110,00	13,00	C	FPM	109292		MAN	06 56289 0028			
35145	80,00	105,00	15,00	B green	NBR	81545		MAN	06 56289 0031			
35147	85,00	105,00	13,00	BS blue	NBR	32425	differential	MAN	06 56289 0033	096067	12011359	81-35092-00
35149	110,00	130,00	13,00	C	NBR	18863	rear axle	MAN	06 56289 0035		12012065	
35150	115,00	140,00	13,00	CS green	NBR	51724	front axle	MAN	06 56289 0037	518166	12003473	81-35102-00
114643	125,00	150,00	13,00	CS	NBR	81334	crankshaft	MAN	06 56289 0038	635600	12011419	
35151	135,00	165,00	13/10	C blue	NBR	50339	rear axle	MAN	06 56289 0039			
35152	145,00	165,00	13,00	C	NBR	19960	front-/rear axle	MAN	06 56289 0040			
32782	145,00	170,00	15,00	C	NBR	18951	crankshaft	MAN	06 56289 0041		01003537	
35153	175,00	200,00	15,00	C green	NBR	82397	front-/rear axle	MAN	06 56289 0045			
35154	190,00	220,00	15,00	C	NBR	19924		MAN	06 56289 0046			
33421	85,00	105,00	13,00	B WD	FPM	36789	differential	MAN	06 56289 0047	008680		
68551	85,00	105,00	13,00	B WD	FPM	36789	rear axle	MAN	06 56289 0048	008680	12012549	81-35089-00
51458	160,00	180,00	10,00	A/BS	NBR	94701	front axle	MAN	06 56289 0050	008672	01019887	
35155	160,00	180,00	10,00	A/B WD blue	NBR	94702	front axle	MAN	06 56289 0052		01019888	
35156	145,00	175,00	13,00	A/B W blue	NBR	82427	rear axle	MAN	06 56289 0063		12011407	
34818	145,00	175,00	14,00	BS	NBR	4376	rear axle	MAN	06 56289 0064		12011374	
34819	145,00	175,00	13,00	A/B W blue	NBR	82427	rear axle	MAN	06 56289 0065		12011407	
84522	145,00	175,00	13,00	C	FPM	34644	rear axle	MAN	06 56289 0066	033146		
114768	85,00	105,00	10,00	AW/BS LD	FPM	82528	gearbox	MAN	06 56289 0067	033464	12013757	
114613	95,00	120,00	13,00	C	NBR	51723	rear axle	MAN	06 56289 0111	042684	12011398	81-35093-00
114629	105,00	130,00	13,00	C	NBR	18846	front axle	MAN	06 56289 0113	042846	12011403	81-35098-00
114657	150,00	170,00	15,00	CS	NBR	61249	crankshaft	MAN	06 56289 0115		12011423	
35690	85,00	105,00	10,00	B blue	NBR	50341	gearbox	MAN	06 56289 0132	556807	12011340	
96083	90,00	110,00	15,00	BS RD LA	FPM	94728	crankshaft	MAN	06 56289 0139			
114665	170,00	190,00	15,00	C	NBR	18976	crankshaft	MAN	06 56289 0143		01003567	
34645	145,00	175,00	13,00	C	FPM	34644	rear axle	MAN	06 56289 0145	033146		

dph-no	dim 1	dim 2	dim 3	Style	Material	dph oil seal no.	Application	Type	OEM-NO	Elring	Corteco	Reinz
68541	85,00	105,00	13,00	BS	NBR	32425	gearbox	MAN	06 56289 0167	096067	12011359	
113662	80,00	100,00	12,00	BS	NBR	50348	crankshaft	MAN	06 56289 0179		01017034	
51884	85,00	105,00	12,00	C	NBR	51710	crankshaft	MAN	06 56289 0181		01017033	
113666	90,00	110,00	13,00	AS W	FPM	113665	crankshaft	MAN	06 56289 0183	514950	20016781	
84394	140,00	160,00	13,00	BS	NBR	70576	rear axle	MAN	06 56289 0186	255637	12011349	
114848	170,00	190,00	15/14	BS blue	NBR	114847	crankshaft	MAN	06 56289 0187		01017575	
80482	80,00	100,00	12,00	B	FPM	47315	crankshaft	MAN	06 56289 0191	042420		
110697	100,00	120,00	13/10	C	NBR	50801	wheel hub	MAN	06 56289 0207			
82278	95,00	115,00	13,00	CS	NBR	81441		MAN	06 56289 0215			
80283	120,00	150,00	15/12	CS	NBR	48002	front axle	MAN	06 56289 0221			
18904	120,00	150,00	15,00	C	NBR	18904	front axle	MAN	06 56289 0221	042943		
113661	120,00	140,00	13,00	AS	NBR	42932	crankshaft	MAN	06 56289 0223		12000556	
93449	110,00	140,00	13,00	CS	NBR	18871	wheel hub	MAN	06 56289 0236	105422	01003701	
93450	110,00	140,00	13,00	CS	NBR	18871		MAN	06 56289 0241			
114647	130,00	160,00	15,00	AS	NBR	19889	crankshaft	MAN	06 56289 0244		12011213	
96261	145,00	175,00	14/12	A WD	FPM	96262	wheel hub	MAN	06 56289 0248			
114464	85,00	150/169,00	12/31,5	BS RD SP	FPM	114404	crankshaft	MAN	06 56289 0266		01019881	
35259	100,00	130,00	13,00	AW/BS	NBR	61447	front-/rear axle	MAN	06 56289 0267			
114652	135,00	175,00	15,5/20	KA	NBR	114420	crankshaft	MAN	06 56289 0268	357170	01019880	
114614	95,00	120,00	13,00	C	NBR	51723	rear axle	MAN	06 56289 0273		12011398	
114783	80,00	135/154,00	13,5/18	BS RD SP	FPM	114398	crankshaft	MAN	06 56289 0293	379300	01020677	
114648	130,00	160,00	16,00	A/BS WD	FPM	81341	crankshaft	MAN	06 56289 0306		01017013	
82322	145,00	175,00	16,00	AW/BS WD	FPM	82321	rear axle	MAN	06 56289 0309	826774	01016698	
81610	100,00	130,00	12,00	A	NBR	18831	crankshaft	MAN	06 56289 0315	519243	01018440	
114776	85,00	145,00	12/37	SP	FPM	95864	differential	MAN	06 56289 0319	447080	01017059	
113664	81,00	100,00	10,00	A/B	NBR	113663	crankshaft	MAN	06 56289 0320		01027678	
80856	90,00	110,00	10,00	A SP	NBR	36835	crankshaft	MAN	06 56289 0321		01020678	
82967	95,00	115,00	10/9,5	A/B	NBR	82966	crankshaft	MAN	06 56289 0322		01018219	
113671	95,00	120,00	10,00	A/B	NBR	113670	crankshaft	MAN	06 56289 0323		01018243	
37845	100,00	130,00	12,00	A	NBR	18831	crankshaft	MAN	06 56289 0324		01018440	
114608	95,00	115,00	10/9,5	A/B	NBR	82966	crankshaft	MAN	06 56289 0325		01018219	
114773	85,00	110,00	10/14	A/B Duo	FPM	114400	crankshaft	MAN	06 56289 0329		01029919	
113844	145,00	175,00	13,00	AW/B	FPM	59311	rear axle	MAN	06 56289 0330			
82113	145,00	175,00	14,00	A/BS W	NBR	81021	rear axle	MAN	06 56289 0332	768065	12014740	
114656	145,00	175,00	13,00	AW/B	FPM	59311	wheel hub	MAN	06 56289 0333		12014739	

									OEM-NO			
dph-no	dim 1	dim 2	dim 3	Style	Material	dph oil seal no.	Application	Type	OEM-NO	Elring	Corteco	Reinz
32639	145,00	175,00	13,00	A/B W blue	NBR	82427	rear axle	MAN	06 56289 0334	817023	12015499	81-91001-00
6652	145,00	175,00	14,00	A/BS blue	NBR	81021	rear axle	MAN	06 56289 0335	768065	12014740	81-91002-00
113851	112,00	132,00	7,50	BAB	FPM	51488	rear axle	MAN	06 56289 0344			
80358	80,00	100,00	10,00	AW/BS WD	FPM	47995	differential	MAN	06 56289 0349	104290	01020467	
61486	80,00	100,00	10,00	BS	NBR	42528	crankshaft	MAN	06 56289 0353	104330	01020468	
117301	85,00	105,00	9,5/13	A/B WD	FPM	93554	differential	MAN	06 56289 0357		01029594	
117306	85,00	105,00	13/9,5	A/BS	NBR	93553	differential	MAN	06 56289 0361		01029595	
113667	160,00	180,00	10,00	A/B WD	NBR	94702	front axle	MAN	06 56289 0365	104470	01019888	
83892	160,00	180,00	10,00	A/BS	NBR	94701	front axle	MAN	06 56289 0366	104480	01019887	
109684	100,00	130,00	12,00	A/B	FPM	109686	wheel hub	MAN	06 56289 0369	374360	01020679	
82320	145,00	175/205,00	9/14	SP	NBR	80460	rear axle	MAN	06 56289 0371	147730	01027787	
81568	130,00	160,00	16,00	A/BS WD	FPM	81341	crankshaft	MAN	06 56289 0385	290180	01017013	
93474	145,00	175,00	16,00	AW/BS WD	FPM	82321	rear axle	MAN	06 56289 0386	826774	01016689	
111280	132,00	160,00	10,00	B WD	FPM	111357	crankshaft	MAN	06 56289 0387	485890	12020156	
114631	105,00	130,00	12/17	AW/BS	FPM	114413	crankshaft	MAN	06 56289 0389		01029917	
118375	116,00	140,00	10,00	WD	FPM	120126	crankshaft	MAN	06 56289 0393			
117053	85,00	110,00	12/17	AW/BS	FPM	119376	crankshaft	MAN	06 56289 0394		01033971	
35157	200,00	230,00	15,00	C	NBR	18992		MAN	06 56292 0101			
84395	138,00	160,00	15,00	AS LD	MVQ	15300		MAN	51 01510 0072			
15302	85,00	110,00	13/15,00	AS RD green	MVQ	15301		MAN	51 01510 0077			
37547	120,00	140,00	13,00	A LD	MVQ	37547	crankshaft	MAN	51 01510 0133			
36178	120,00	140,00	13,00	AW/BS LD	FPM	112531	crankshaft	MAN	51 01510 0133	090158	12014877	
80244	105,00	130,00	12,00	AW/BS RD vlies	FPM	112532	crankshaft	MAN	51 01510 0138	288039		
37179	120,00	140,00	13,00	A/B LD SP	PTFE/ACM	109246	crankshaft	MAN	51 01510 0141		01016688	
61360	105,00	130,00	12,00	AW/BS RD vlies	FPM	112532	crankshaft	MAN	51 01510 0150			
109688	110,00	130,00	13,00	A/BS LD	FPM/PTFE	109691	crankshaft	MAN	51 01510 0151	323772	12015384	81-33801-00
111394	60,40	80,00	12,00	BS RD SP	FPM	109799	crankshaft	MAN	51 01510 0152	323780	12015383	81-24895-00
108819	120,00	140,00	13,00	A/B LD SP	PTFE/ACM	109246	crankshaft	MAN	51 01510 0196	766828	01016688	
82544	105,00	130,00	12,00	AS W RD SP	PTFE	109245	crankshaft	MAN	51 01510 0197	766852	01017541	81-23112-30
70512	120,00	140,00	13,00	A/B LD SP	PTFE/ACM	109246	crankshaft	MAN	51 01510 0206	766828	01016688	81-23113-30
112553	120,00	140,00	13,00	A/B LD SP	PTFE/ACM	109246	crankshaft	MAN	51 01510 0216			
111400	110,00	130,00	13,00	A/BS LD	PTFE	109691	crankshaft	MAN	51 01510 0218	503208	20029606	81-33801-00
113044	66,00	90,00	12,00	SP	PTFE	114371	crankshaft	MAN	51 01510 0219	061680	15027677	81-27522-10
112554	105,00	130,00	12,00	AS W RD SP	PTFE	109245	crankshaft	MAN	51 01510 0226	766852	01017541	
109687	66,00	90,00	12,00	BS RD LA	FPM	109690	crankshaft	MAN	51 01510 0228	749983		81-34421-00

dph-no	dim 1	dim 2	dim 3	Style	Material	dph oil seal no.	Application	Type	OEM-NO	Elring	Corteco	Reinz
112555	100,00	130,00	12,00	AW/BS RD	PTFE	114411	crankshaft	MAN	51 01510 0236		20031177	
114625	100,00	130,00	12,00	AW/BS RD	PTFE/ACM	114411	crankshaft	MAN	51 01510 0273	158510	20031177	
81122	105,00	130,00	12,00	AS W RD SP	PTFE	109245	crankshaft	MAN	51 01510 6004	766852	01017541	81-23112-30
114694	55,00	70,00	8,00	AS W RD	PTFE/AEM	114357	crankshaft	MAN	51 96501 0535		20031171	
114682	50,80	65,00	8,00	B WD	FPM	114348	crankshaft	MAN	81 32050 0219		12012592	
114756	78,00	100,00	10,00	AW/BS LD	FPM	114390	crankshaft	MAN	81 32050 0451		12013860	
114871	145,00	175,00	13/12	A/BS WD	FPM	114870	crankshaft	MAN	81 35710 6015			
35200	50,00	70,00	12,00	C	NBR	18333	crankshaft	MAN	81 35925 0007			
109808	76,00	100/137,00	10/15,5	SP	FPM	109812	ABS with pulse wheel	MAN	81 52403 6000		01019466	
109809	81,00	100/137,00	10/15,5	SP	FPM	109813	ABS with pulse wheel	MAN	81 52403 6001	265960	01026330	
111512	95,00	116,50	11,00	SP	FPM	113829	wheel hub	MAN	81 52403 6005	473310		
113830	95,00	116,50	11,00	SP 1 combi	FPM	113832	wheel hub	MAN	81 52403 6006			
94714	160,00	190,00	15,00	C	NBR	82396	rear axle	MAN	81 96501 0026			
35201	45,00	62,00	10,00	A	NBR	18223		MAN	81 96501 0032			
35202	120,00	150,00	15/12	CS	NBR	48002	front axle	MAN	81 96501 0136			
35203	26,00	35,00	7,00	B	NBR	17670	crankshaft	MAN	81 96501 0296			
35204	7,00	16,00	7,00	B	NBR	35205	transmission	MAN	81 96501 0306			
35206	70,00	90,00	10,00	B	NBR	18162	crankshaft	MAN	81 96501 0308		01002684	
35207	14,00	24,00	7,00	B	NBR	19033		MAN	81 96501 0313	037109		
35208	22,00	30,00	7,00	B	NBR	19269		MAN	81 96501 0388			
114705	60,00	74,00	10/8	AS W LD	FPM	113749	gearbox	MAN	81 96501 0410		12013365	
35209	55,00	80,00	10,00	A	NBR	18431	transmission	MAN	81 96501 0445	446602		
35210	85,00	105,00	10,00	B blue	NBR	50341	gearbox	MAN	81 96501 0446	556807	12011340	
35211	42,00	60,00	10,00	B	NBR	18169		MAN	81 96501 0448	040339		
35614	11,00	17,00	4,00	A	NBR	19101	injection pump	MAN	81 96501 0477			81-31533-00
117299	75,00	100,00	13,00	B	NBR	20038		MAN	81 96501 0485			
35212	25,00	35,00	7,00	B	NBR	4378	gearbox	MAN	81 96501 0521	038083	12014616	
117330	25,00	35,00	8,00	AD	NBR	47303		MAN	81 96501 0530	008427		
114685	52,00	72,00	10,00	B	FPM	114350	crankshaft	MAN	81 96501 0798		01030105	
84396	42,00	55,00	9,00	B	FPM	48010	brake cam shaft	MAN	81 96501 0842			
84198	42,00	58,00	7,00	BS	NBR	37347	rear axle	MAN	81 96501 0843	010197		
117336	22,00	35,00	7,00	A LD	MVQ	94526	crankshaft	MAN	81 96501 0859	092614		
109841	145,00	175,00	13,00	C	FPM	97801	wheel hub	MAN	81 96501 0860	033146	12015499	
6649	145,00	175,00	14,00	A/BS blue	NBR	81021	rear axle	MAN	81 96501 0861		12014740	
6654	145,00	175,00	13,00	A/B W blue	NBR	82427	rear axle	MAN	81 96501 0862			

dph-no	dim 1	dim 2	dim 3	Style	Material	dph oil seal no.	Application	Type	OEM-NO	Elring	Corteco	Reinz
96084	25,00	35,00	7,00	B	NBR	4378	gearbox	MAN	81 96501 0864			
114769	85,00	105,00	10,00	AW/BS LD	FPM	82528	gearbox	MAN	81 96501 0966		12013757	
117332	25,00	32,00	5,00	B OF	NBR	48055	gearbox	MAN	81 96502 0117	134600	01002919	
117339	42,00	62,00	10,00	AS RD	ACM	35050	gearbox	MAN	81 96502 0200		12013896	
50681	85,00	105,00	10,00	B LD	FPM	4047	gearbox	MAN	81 96502 0208	033464	12013757	
114686	52,00	87,00	10/18	AS W WD SP	ACM	114351	crankshaft	MAN	81 96502 0216		01029920	
93757	48,00	75,00	8,00	B RD	FPM	4545	gearbox	MAN	81 96502 0225	033472	12011307	
69158	48,00	69,00	10,00	B RD	FPM	47988	gearbox	MAN	81 96502 0226		12011306	
82737	85,00	105,00	10,00	B	NBR	50341	gearbox	MAN	81 96502 0247	556807		
34634	48,00	65,00	10,00	B green	NBR	81637	gearbox	MAN	81 96502 0248	040991	12011331	
114736	70,00	90,00	10,00	AS W LD	FPM	47944	gearbox	MAN	81 96502 0251		12014736	
117371	125,00	150,00	10,00	SP RD	FPM/ACM	97662	gearbox	MAN	81 96502 0313			
33650	20,00	35,00	7,00	A	NBR	17512	gearbox	MAN	81 96502 0326	106208	12010825	
80059	105,00	130,00	12,00	AS	NBR	97860	gearbox	MAN	81 96502 0349	282200	12011062	
61236	105,00	130,00	12,00	A/BS LD	FPM	48035	crankshaft	MAN	81 96502 0350	314994	01018282	
93880	26,00	37,00	7,00	AS	NBR	32164	gearbox	MAN	81 96502 0356			
117342	52,00	68,00	8,00	A/BS RD	FPM	96995	gearbox	MAN	81 96502 0403	141960	01029746	
114618	95,30	114,29	11,88	BS WD LA	FPM	96979	crankshaft	MAN	81 96502 0451		12012235	
114687	52,00	97,00	10/18	AS W WD SP	FPM	114353		MAN	81 96502 0676		01020680	
117331	90,00	110,00	15,00	AW BD	FPM	96082		MAN	81 96502 0699	762830		
93804	55,00	75,00	8,00	B RD	FPM	36792	gearbox	MAN	81 96502 0761	284645	12011308	
117340	48,00	65,00	10,00	AS W RD	AEM/PTFE	114341	crankshaft	MAN	81 96502 0934		20016209	
117363	165,00	190,00	13,00	A blue	NBR	4374	front-/rear axle	MAN	81 96502 0973			
117337	25,00	35,00	7,00	AS	NBR	84590	injection pump	MAN	81 96503 0068			
113846	87,26	120,76	15,40	KA SP	FPM/ACM	113845	crankshaft	MAN	81 96503 0161		12020256	
113835	105,00	140,00	18,00	KA SP	FPM	113833	wheel hub	MAN	81 96503 0171		12040000	
96174	135,00	175,00	18,00	KA/BS SP	FPM/NBR	96648	wheel hub	MAN	81 96503 0188	009310	12020157	
114850	146,00	95,20	16,50	SP	NBR	114849		MAN	81 96503 0259			
113834	135,00	175,00	18,00	KA SP	FPM/NBR	118425	ABS	MAN	81 96503 0260			
113841	135,00	175,00	18,00	SP	FPM/ACM	113840	wheel hub	MAN	81 96503 0298			
111281	132,00	172,00	12,00	KA/BS SP	FPM	111358	wheel hub	MAN	81 96503 0333			
98697	135,00	175,00	18,00	KA/BS SP	FPM/NBR	96648	wheel hub	MAN	81 96503 0398		12020157	
118376	116,00	151,00	11,00	SP	FPM	119761	with impulse wheel	MAN	81 96503 0414			
119244	85,00	150,00	16,35/20	KA/BS SP	FPM/ACM	118628	axle transmission	MAN	81 96503 0442			
118410	85,00	150,00	16,35/20	KA/BS SP	FPM/ACM	118628	axle transmission	MAN	81 96503 0443			

dph-no	dim 1	dim 2	dim 3	Style	Material	dph oil seal no.	Application	Type	OEM-NO	Elring	Corteco	Reinz
113843	139,00	170,00	11,00	B LA SP	FPM	113842	crankshaft	MAN	81 96503 0445	517130	12019163	
117372	139,00	170,00	11,00	B SP LA	FPM	113842	crankshaft	MAN	81 96503 0530			
113827	139,00	175/205,00	11/16,30	SP	FPM	113828	wheel hub	MAN	81 96503 6000	457300	12019683	
117364	190,00	220,00	15,00	C	NBR	93619	axle	MAN	85 90001 0001			
117335	22,00	35,00	7,00	A LD	MVQ	94526	crankshaft	MAN	K0 00117 2559			
117307	105,00	130,00	15,00	AW/BS F LD	FPM	82048	crankshaft	MAN	K0 00242 1820			
117304	25,00	62,00	10,00	AW/BS F	FPM	82336	crankshaft	MAN	K0 00414 8451			
113900	48,00	65,00	8,00	SP	NBR	113899	crankshaft	MAZDA	B-216-26-154		19016502	
117311	30,00	44,00	7,00	AS RD	NBR	104536	crankshaft	MAZDA	B630-10-602	022160		81-53228-00
118600	83,00	100,00	9,00	AS LD	MVQ	110016	crankshaft	MAZDA	BP05-011-312			
117310	34,00	48,00	7,00	AS RD	MVQ	104534	crankshaft	MAZDA	F801-10-602	022170		81-53243-00
119237	48,00	70,00	90,00	AS	NBR	43923		Mazda	UH71-26-157			
95233	73,02	101,60	15,87	SP	HNBR	95455	wheel hub	MF	3699800M2		12018598	
119807	54,00	76,00	8/11	BS 2 SP	NBR	119810		Mitsubishi	808443			
119808	51,90	66,00	8/10	BS 2 SP	NBR	119811		Mitsubishi	808444			
113902	37,00	62,00	14/10	CY	NBR	113901		Mitsubishi	837719			
115735	70,00	92,00	12,00	AS LD	FPM	115734		Mitsubishi	31A07-02300			
115733	35,00	50,00	8,00	A RD	ACM	3900	camshaft	Mitsubishi	MD 008762	293946	19015083	
115542	60,00	78,00	7,50	SP	MVQ	115542		Mitsubishi	MD016317			
97087	70,00	92,00	12,00	AS	ACM	97084		Mitsubishi	MH034154			
97088	75,00	100,00	13,00	AS LD	ACM	97085		Mitsubishi	MH034155			
97086	52,00	65,00	9,00	BS RD	ACM	97083		Mitsubishi	MH034220			
84764	78,00	100,00	14,50	A/B RD Vlies	FPM	84763	crankshaft	MWM	6 226 0 856 0014			
118515	178,00	205,00	17,00	SP	NBR	118515		New Holland	9967701		19034568	
117851	48,00	65,00	16,50	SP	FPM	117851	crankshaft	New Holland	85821287		12017310	
114674	49,00	62,00	8,00	SP	NBR	113898	wheel bearing	NISSAN	43431-60B20-000			
114572	35,00	54,85/61,20	8,9/14,70	SP	NBR	113723	differential	OPEL	1 275 5013			
51456	40,00	52/62,00	8,50	AW SP	NBR	51455	front & rear axle	OPEL	328 410		12011155	
97896	59,00	75,00	9/11,5	SP	NBR	97895	wheel hub	OPEL	328 411			
4061	40,00	52/62,00	8,50	AW SP	NBR	51455	front & rear axle	OPEL	328 637	043923	12011155	81-31435-00
97898	50,00	68,00	11,5/8,2	SP	FPM	97897	differential	OPEL	354 197			
94781	36,00	55/61,00	9/14,5	SP	FPM	94780	drive shaft	OPEL	374 151			
97901	35,00	54,00	10/15	AW/BS WD SF	ACM	97900	front axle	OPEL	374 197		12017376	
94783	35,00	54,00	13,00	AS RD SP	ACM	94782	crankshaft	OPEL	374 227		19033964	
116813	35,00	55,00	8/14	HTB5Y	NBR	118408	differential	OPEL	374 594		19033952	

dph-no	dim 1	dim 2	dim 3	Style	Material	dph oil seal no.	Application	Type	OEM-NO	Elring	Corteco	Reinz
116814	35,00	73,00	8/14	HTB5Y	NBR	118409	differential	OPEL	374 595		19033965	
80988	52,00	72,00	10,00	AS RD	ACM	80987	crankshaft	OPEL	406 748			
80990	34,00	72,00	10/12	AS RD	ACM	80989	rear axle	OPEL	406 753			
94784	34,00	72,00	10/12	AS RD	ACM	80989	rear axle	OPEL	406 766			
95603	47,62	80,26	6,8/13,3	A SP W RD	FPM	95622	differential	OPEL	406 774		01031231	
94776	44,00	72,00	10/16	B RD SP	ACM	94775	differential	OPEL	406 777			
94778	35,00	65,00	8,30	A/BS WD	ACM	94777	differential	OPEL	414 537			
115529	42,00	54,00	6,00	AS RD	FPM/ACM	112276	crankshaft	OPEL	440 2706	157200	12018755	81-34413-00
116664	55,00	68,00	8,00	AW/BS RD	PTFE/AEM	115399	crankshaft	Opel	5 638 605		20030111	81-36228-00
97873	50,00	68,00	7/10,5	SP	FPM	97872	crankshaft	OPEL	614 800		19033966	
114779	90,00	110,00	12,00	AS WD combi	PTFE/AEM	114405	crankshaft	OPEL	614 802		20019546	81-20745-50
96023	81,00	100,10	11,45	AW/BS LD	FPM	97870	crankshaft	OPEL	614 805		12010747	
37638	80,00	98,00	10,00	AS LD	MVQ	37638	transfer gearbox	OPEL	614 811			
37640	80,00	98,00	10,00	A/BS LD	FPM	81060	crankshaft	OPEL	614 811		12013882	
50178	54,00	82,00	11,45	AS LD	ACM	4235	crankshaft	OPEL	614 814	231665	12010693	81-21343-00
15254	77,00	100,10	11,45	AW/BS LD	FPM	15248	crankshaft	OPEL	614 815	694665	12013857	81-20667-30
50705	81,00	100,10	11,45	AW/BS LD	FPM	97870	crankshaft	OPEL	614 816	694673	12010747	81-24077-00
50823	81,00	100,10	11,45	AW/BS LD	MVQ	50823	crankshaft	OPEL	614 816			
51453	86,00	104,00	11,00	AS W LD	FPM	51452	crankshaft	OPEL	614 817	581879	12010749	81-25517-00
4236	54,00	82,00	11,45	AS LD	ACM	4235	crankshaft	OPEL	614 818	231665	12010693	81-21343-00
51454	90,00	104,00	11,00	A/BS LD	FPM	93733	crankshaft	OPEL	614 819	694770	12014523	81-27294-10
37638	80,00	98,00	10,00	AS LD	MVQ	37638	transfer gearbox	OPEL	614 820			
50179	80,00	98,00	10,00	A/BS LD	FPM	81060	crankshaft	OPEL	614 820		12013882	81-24908-10
81062	80,00	98,00	10,00	A/BS LD	FPM	81060	crankshaft	OPEL	614 821	590797	12013882	81-24908-10
94863	40,00	52,00	6,00	AS RD	FPM	94862	crankshaft	OPEL	614 822	060120	12015430	
93234	81,00	100,10	11,45	AW/BS LD	MVQ	50823	crankshaft	OPEL	614 824			
96434	87,00	100,00	8,50	AS LD	FPM	97874	crankshaft	OPEL	614 825	060110	12015429	81-53299-00
97871	81,00	100,10	11,45	AW/BS LD	FPM	97870	crankshaft	OPEL	614 826		12010747	
50824	90,00	104,00	11,00	A/BS LD	MVQ	50824	crankshaft	OPEL	614 827			
50704	90,00	104,00	11,00	A/BS LD	FPM	93733	crankshaft	OPEL	614 827	694770		81-27294-10
50824	90,00	104,00	11,00	A/BS LD	MVQ	50824	crankshaft	OPEL	614 829			
59233	90,00	104,00	11,00	A/BS LD	FPM	93733	crankshaft	OPEL	614 829	694770	12014523	81-27294-10
94499	80,00	98,00	10,00	A/BS LD	FPM	81060	crankshaft	OPEL	614 830	590797	12013882	81-24908-10
59234	54,00	82,00	11,45	AS LD	ACM	4235	crankshaft	OPEL	614 831	231665		81-21343-00
95604	50,00	68,00	9,00	AS RD FILZ	FPM	95621	crankshaft	OPEL	614 835		19033958	

dph-no	dim 1	dim 2	dim 3	Style	Material	dph oil seal no.	Application	Type	OEM-NO	Elring	Corteco	Reinz
110581	90,00	110,00	12,00	AS W LD	PTFE/AEM	114405	crankshaft	OPEL	614 838		20019546	
15246	90,00	110,00	12,00	AW/BS LD	FPM	15246	crankshaft	OPEL	614 838	702994		
96360	90,00	104,00	11,00	A/BS LD	FPM	93733	crankshaft	OPEL	614 840	694770	20033412	
111550	99,00	114,00	8,00	A	FPM/ACM	112394	crankshaft	OPEL	614 855			
37462	35,00	48,00	7,00	AS RD	MVQ	36781	crankshaft	OPEL	636 838		20011244	
81065	55,00	70,10	5,50	AW/B LD	FPM	51306	camshaft	OPEL	636 839	694711		81-27317-00
51309	55,00	70,10	5,50	AW/B LD	MVQ	51309	camshaft	OPEL	636 839			
80070	35,00	48,00	7,00	AS RD	MVQ	36781	crankshaft	OPEL	636 841	702269	20011244	81-24909-10
115690	30,00	45,00	8,00	AS WD	FPM	115689	crankshaft	OPEL	636 842			
15255	45,00	60,00	9/7	AS RD	ACM	36895	crankshaft	OPEL	638 187	590762	12012250	81-19195-00
80039	45,00	60,00	9/7	AS RD	ACM	36895	crankshaft	OPEL	638 193	590762	12012250	
50706	55,00	70,10	5,50	AW/B LD	FPM	51306	camshaft	OPEL	638 194	694711		81-27317-00
51309	55,00	70,10	5,50	AW/B LD	MVQ	51309	engine	OPEL	638 194			
97397	55,00	68,00	8,00	A/BS RD	FPM	97403		OPEL	638 196	477010	12015711	81-34158-00
97379	42,00	55,00	7,00	AS W RD	FPM/ACM	97538	FPM/ACM crankshaft	OPEL	638 199	127610	20020389	81-33489-00
110586	48,00	65,00	10,00	AW/BS RD F	FPM	36203	crankshaft	OPEL	638 269	586676		81-17404-50
110599	30,00	40,00	7,00	AS RD W	FPM	47982	camshaft	OPEL	646 260	508489		81-15512-50
114341	30,00	40,00	7,00	AS RD W	PTFE/AEM	114341	crankshaft	OPEL	646 260		20019549	
37637	26,00	42,00	8,00	A/BS RD	FPM	81064	crankshaft	OPEL	646 262		12013858	
37636	26,00	42,00	8,00	AS RD	MVQ	37636	crankshaft	OPEL	646 262	049557		81-24911-00
37866	31,00	50,00	8,00	AS RD	FPM	37865	crankshaft	OPEL	646 263	330736	12013458	
68536	31,00	50,00	8,00	AS RD	FPM	37865	crankshaft	OPEL	646 265		12013458	81-25516-10
36382	35,00	50,00	8,00	A RD	ACM	3900	crankshaft	OPEL	646 266			81-21798-40
81063	26,00	42,00	8,00	A/BS RD	FPM	81064	crankshaft	OPEL	646 267	755141	12013858	
94336	18,00	32,00	6,00	AS RD	ACM	94335	oil pump	OPEL	646 268	490800	12015450	
94944	38,00	50,00	8,00	A/BS RD	FPM	111535	crankshaft	OPEL	646 269	763918	12014494	81-28236-00
80414	38,00	50,00	8/5,5	AW/BS RD	MVQ	80414	crankshaft	OPEL	646 269			
68535	26,00	42,00	8,00	A/BS RD	FPM	81064	crankshaft	OPEL	646 270	755141	12013858	81-27295-00
110600	38,00	50,00	8,00	A/BS RD	FPM	111535	crankshaft	OPEL	646 271	763918	12014494	
81577	26,00	42,00	8,00	AS RD	MVQ	37636	crankshaft	OPEL	646 274			
81064	26,00	42,00	8,00	A/BS RD	FPM	81064	crankshaft	OPEL	646 274			81-27295-00
96024	31,00	50,00	8,00	AS RD	FPM	37865	crankshaft	OPEL	646 289	694739	12013458	
97203	35,00	50,00	8,00	AS W RD	FPM/ACM	97204	crankshaft	OPEL	646 290	694657	12013459	81-21798-00
109271	26,00	42,00	8,00	A/BS RD	FPM	81064	crankshaft	OPEL	646 816		12013858	
111537	42,00	55,00	10,00	BS	NBR	111536	gearbox	OPEL	714 400			

dph-no	dim 1	dim 2	dim 3	Style	Material	dph oil seal no.	Application	Type	OEM-NO	Elring	Corteco	Reinz
94774	42,00	55,00	10/8	A/BS LD	FPM	94773	gearbox	OPEL	714 408			
94772	23,00	35,00	8,00	BS RD	FPM	94771	gearbox	OPEL	714 409		12017271	
94770	21,00	32,00	9,00	B combi	ACM	94769	gearbox	OPEL	714 412		01019153	
96450	23,00	35,00	9,00	CS RD	FPM	111539	gearbox	OPEL	714 413		12018671	
114551	24,00	35,00	8,00	BS RD	FPM	94771	gearbox	OPEL	714 809			
80992	38,00	52,00	12,00	AS LD	ACM	80991	gearbox	OPEL	724 512			
95605	38,00	52,00	10,00	B	NBR	51486	manual transmission	OPEL	724 524			
33336	7,00	16,00	7,00	A	NBR	17345	gearbox	OPEL	724 876			
111540	30,00	42,00	7,00	AS RD	ACM	82102	gearbox	OPEL	730 669			
33337	14,00	24,00	7,00	A	NBR	17391	crankshaft	OPEL	732 225		12010784	
111541	13,00	26,00	7,00	AS blue	NBR	19061	gearbox	OPEL	732 235			
114583	40,00	62,00	10,00	A	NBR	18107	automatic gearbox	OPEL	744 500	330809	12010936	
37868	17,00	28,00	7,00	B	NBR	37867	crankshaft	OPEL	819 830		12015322	
33338	28,00	40,00	7,00	AS blue	NBR	93614	gearbox	OPEL	902 678	164500	12010874	
82506	60,32	79,37	9,52	AS RD	FPM	82504	crankshaft	PERKINS	2418 F 436		12014981	
82507	133,35	158,75	12,70	AS LD	FPM	82505	crankshaft	PERKINS	2418 F 475		12010753	
82474	90,00	110,00	7,00	AS W LD	FPM	82473	crankshaft	PEUGEOT	0119 06			81-34456-00
118512	90,00	110,00	10,00	AS W LD	FPM/ACM	118512	crankshaft	PEUGEOT	0119 06	294683	12010750	
114678	50,00	68,00	10,00	A/B W RD	FPM	82470	crankshaft	PEUGEOT	0127 11	508470	12013865	81-16737-20
84463	90,00	110,00	7,00	AS W LD	FPM	82473	crankshaft	PEUGEOT	0127 28			81-34456-00
117108	90,00	110,00	7,00	AS W LD	FPM/ACM	117108	crankshaft	PEUGEOT	0127 28	508209	20015455	81-25925-00
115456	35,00	50,00	8,00	AS WD W	FPM	112621	crankshaft	PEUGEOT	0236 14	302589	12016927	81-21798-50
93531	36,00	50,00	8,00	A W RD	ACM	93530	camshaft	PEUGEOT	0236 21		07012633	81-26244-10
109075	36,00	50,00	7,00	AS W RD	FPM	109074	camshaft	PEUGEOT	0236 44	505366	20015457	81-34403-00
81658	42,00	62,00	7,00	AS W RD	FPM	81657	camshaft	PEUGEOT	032 612			81-25926-10
109055	42,00	62,00	7,00	AS W RD	FPM/ACM	109055	camshaft	PEUGEOT	032 612	508233	20015456	
82479	42,00	60,00	8,00	A W RD	ACM	59256	crankshaft	PEUGEOT	0514 11	767921	07011550	81-27333-00
3903	78,00	100,00	10,00	A LD	MVQ	3902	crankshaft	PEUGEOT	0514 14	034347		81-23578-00
114390	78,00	100,00	10,00	AW BS LD	FPM	114390	crankshaft	PEUGEOT	0514 14		12013860	
3901	35,00	50,00	8,00	A RD	ACM	3900	crankshaft	PEUGEOT	0514 15	293946	12011547	81-21798-30
114586	42,00	62,00	10,00	AS RD	ACM	35050	crankshaft	PEUGEOT	0514 21	040363	12013896	81-21001-10
59261	42,00	66,00	8/7	AS W RD	MVQ	59260	crankshaft	PEUGEOT	0514 38			
96323	85,00	105,00	11,00	AS W LD	MVQ	96323	crankshaft	PEUGEOT	0514 40			
59263	85,00	105,00	12,00	AS W LD	FPM/ACM	114899	crankshaft	PEUGEOT	0514 40	315494	12012347	
93435	42,00	66,00	6,00	BS W RD	FPM/ACM	93433	crankshaft	PEUGEOT	0514 72	505740	20018081	81-31863-00

dph-no	dim 1	dim 2	dim 3	Style	Material	dph oil seal no.	Application	Type	OEM-NO	Elring	Corteco	Reinz
84462	85,00	105,00	8,00	ASW LD	FPM/ACM	112606	crankshaft	PEUGEOT	0514 74	135110	20018066	81-23708-50
115457	35,00	50,00	7,00	A/B RD	FPM	50167	crankshaft	PEUGEOT	0807 14	757292	20018100	81-25451-10
109077	38,00	50,00	6,00	AS RD	FPM	109076	camshaft	PEUGEOT	0807 24	135140	20018317	81-34146-00
115459	27,00	47,00	7,00	AS W RD	ACM/PTFE	114095	camshaft	PEUGEOT	0807 28			
3907	40,00	49,60	5,5/7,30	AO LD	MVQ	3906	crankshaft	PEUGEOT	2074 07	314501	46083012	81-21649-00
3905	60,50	78,00	9,00	A RD	MVQ	3904	crankshaft	PEUGEOT	2109 22		46083011	
111817	23,00	36,00	6/7	A W RD	NBR	111391	gearbox	PEUGEOT	2109 40	131860	07015547	
3899	40,00	58,00	10/17	AS2 LD W	NBR	114012	differential	PEUGEOT	3121 09	102946		
115082	29,85	47,00	9,9/17	AS2 W RD blue	NBR	114902	differential	PEUGEOT	3121 10		07011583	
113050	29,85	47,00	9,90	AS W WD	FPM	113050	differential	PEUGEOT	3121 10			
98169	29,85	47,00	11,30	combi	ACM	95498	differential	PEUGEOT	3121 26	128240	20015497	
115081	40,00	58,00	11,30	AS SP WD	ACM	96528	differential	PEUGEOT	3121 27	128250	07015496	
117122	40,00	54,00	6,80	A W LD	FPM	117121	differential	PEUGEOT	3121 40		20026877	
117125	27,94	56,00	8,00	AS W RD	FPM	117124	differential	PEUGEOT	3121 42		20026878	
98170	40,00	58,00	10,00	A W WD	FPM/ACM	117114	rear axle	PEUGEOT	3121 44	504581	20020137	81-38026-00
4142	45,00	62,00	10,00	A	NBR	18223	crankshaft	PEUGEOT	3345 10		12010954	
18228	45,00	62,00	12,00	A	NBR	18228	crankshaft	PEUGEOT	3345 10			
119846	55,00	80,00	8,00	AS	NBR	42903	crankshaft	PEUGEOT	3723.06		120109858	
3898	42,00	62,00	10,00	A	NBR	18175	wheel hub	PEUGEOT	3724 08	040355	12011236	
3897	40,00	52,00	7,00	A	NBR	18068	wheel hub	PEUGEOT	3724 12	321508	12019046	
3896	45,00	60,00	10,00	A	NBR	18215	wheel hub	PEUGEOT	3724 18	048410	12010951	
113906	52,00	75,00	14,70	BS	NBR	113905	crankshaft	PEUGEOT	3724 30		12013760	
33352	15,00	24,00	7,00	B	NBR	17404	manual gearbox	PORSCHE	900 112 00150	037133		
33353	28,00	40,00	7,00	B	NBR	33354		PORSCHE	900 112 01940			
33355	14,00	24,00	7,00	A	NBR	17391		PORSCHE	900 112 02950			
93634	64,50	85,00	10,00	A LD	MVQ	93633		PORSCHE	901 102 91100			
113092	48,00	68,00	10,00	AS RD	ACM	32706	crankshaft	PORSCHE	943 397 01901			
93581	48,00	65,00	10,00	A	NBR	18283	crankshaft	PORSCHE	999 113 01250	388904		81-17404-00
93582	60,00	80,00	10,00	A	NBR	81629	crankshaft	PORSCHE	999 113 02950	041491		81-17085-00
118872	44,00	58,40	10/8	A	NBR	98068		PORSCHE	999 113 03850			
94831	30,00	50,00	10,00	A/BS RD	ACM	80247		PORSCHE	999 113 04940			
82461	65,00	85,00	10,00	A W LD	MVQ	82464	crankshaft	PORSCHE	999 113 05750	494500		81-15332-20
95805	45,00	62,00	10,00	CS	NBR	18227		PORSCHE	999 113 07750			
97234	52,00	68,00	8,00	A	NBR	19706		PORSCHE	999 113 08540			
94832	15,00	24,00	7,00	A	FPM	20500		PORSCHE	999 113 18540	089613		

dph-no	dim 1	dim 2	dim 3	Style	Material	dph oil seal no.	Application	Type	OEM-NO	Elring	Corteco	Reinz
95804	45,00	62,00	10,00	CS	NBR	18227		PORSCHE	999 113 23540			
80592	60,00	85,00	10,00	A RD	FPM	80591	crankshaft	PORSCHE	999 113 26340	557846		81-21108-20
97331	90,00	110,00	12,00	AW/BS LD	FPM	15246	crankshaft	PORSCHE	999 113 26440		12012579	
111395	30,00	50,00	10,00	A W RD	FPM	111402	crankshaft	PORSCHE	999 113 29041	347922		
94677	23,00	35,00	8/11	AS RD	ACM	94679	gearbox	PORSCHE	999 113 32740			
50512	38,00	52,00	7,00	AS W RD	FPM	50511	crankshaft	PORSCHE	999 113 33150	525871		81-16847-10
113087	48,00	68,00	10,00	AS WD		113088		PORSCHE	999 113 34740			
111401	90,00	110,00	12,00	AW/BS LD	FPM	15246	crankshaft	PORSCHE	999 113 42641		12012579	
112375	30,00	42,00	7,00	AS RD	FPM	51727	manual transmission	PORSCHE	999 113 46340			81-33402-00
114556	28,00	40,00	7,00	AS	NBR	93614	crankshaft	RENAULT	094 83 504 09	164500	12010874	
114712	60,00	85,00	12,00	B RD	FPM	47991	gearbox	RENAULT	50 00 803 236		12012578	
119410	130,00	150,00	13,00	AS W LD	PTFE	119417	crankshaft	RENAULT	50 03 087 026			81-37934-00
119409	90,00	110,00	11,00	AS W RD	PTFE/ACM	119416	crankshaft	RENAULT	50 10 359 806	453930	15026914	81-37914-00
119407	150,00	172,00	13,00	AW LD W	PTFE/ACM	119414	crankshaft	RENAULT	50 10 359 807	457220	20026913	81-37933-00
119411	60,00	75,00	10,00	AS W RD	PTFE/ACM	119418	water pump shaft	RENAULT	50 10 550 614		20031971	
119408	90,00	120,00	11,00	AS W RD	PTFE	119415	crankshaft	RENAULT	50 10 861 755			
119412	160,00	190,00	13,00	AS W LD	PTFE	119412	crankshaft	RENAULT	50 16 295 831			
115410	30,00	42,00	7,00	AS RD	FPM	51727	manual transmission	RENAULT	77 00 101 348	365940	20019850	
112260	42,00	54,00	6,00	AS RD	FPM/ACM	112276	crankshaft	RENAULT	77 00 103 245	157200	12018755	81-34413-00
115774	35,00	47,00	6,00	AS RD	FPM	113719	crankshaft	RENAULT	77 00 273 776		20019851	81-15855-40
119286	17,00	28,00	7,00	B RD	ACM	118614	gearbox	RENAULT	77 00 522 671		12011426	
94472	50,00	68,00	10,00	AS W RD	FPM	82470	crankshaft	RENAULT	77 00 619 463			
82471	50,00	68,00	10,00	A/B W RD	FPM	82470	crankshaft	RENAULT	77 00 719 274	508470	12013865	81-16737-20
110810	30,00	42,00	7,00	AS RD	FPM	51727	manual transmission	RENAULT	77 00 749 395	505838	12011839	81-17539-50
	35,00	47,00	7,00	AS RD	MVQ	37506	crankshaft	RENAULT	77 00 854 842			81-25582-00
110863	35,00	47,00	7,00	A W RD	FPM/ACM	112614	crankshaft	RENAULT	77 00 854 842	504483	12013859	81-35506-00
115409	35,00	50,00	8,00	AS W RD	FPM/ACM	97204	crankshaft	RENAULT	77 00 859 691	507806	12013459	
82436	80,00	100,00	8,00	AS W LD	FPM/ACM	82435	crankshaft	RENAULT	77 00 859 692	507822	12015352	
82472	50,00	68,00	10,00	A/B W RD	FPM	82470	crankshaft	RENAULT	77 00 866 877	508470	12013865	81-16737-20
114606	48,00	65,00	10,00	B	NBR	81637	gearbox	RENAULT	77 01 014 157	040991	12011331	
82970	50,00	68,00	10,00	A/B W RD	FPM	82470	crankshaft	RENAULT	77 01 349 140		12013865	
82971	30,00	40,00	7,00	AS RD W	FPM	47982	camshaft	RENAULT	77 01 349 625			
109072	28,00	42,00	5,00	AS RD	FPM	109071	camshaft	RENAULT	77 01 471 376	073890	12018754	81-34408-00
4064	44,70	54,00	5,5/9,1	B SP	NBR	82154	wheel hub	RENAULT	77 03 087 071		12011541	
114593	45,00	60,00	9/7	AS RD	ACM	36895	crankshaft	RENAULT	77 03 087 079		12012250	

dph-no	dim 1	dim 2	dim 3	Style	Material	dph oil seal no.	Application	Type	OEM-NO	Elring	Corteco	Reinz
82480	80,00	100,00	13,00	A/BS W LD	MVQ	37509	crankshaft	RENAULT	77 03 087 080	128210	19930094	
119287	17,00	28,00	7,00	B RD	ACM	118614	gearbox	RENAULT	77 03 087 085		12011426	
96645	36,00	54,00	7,00	AS WD	ACM	96644	differential	RENAULT	77 03 087 087	107794	12015283	
115412	27,95	56,00	10,00	ASW RD	ACM	115411	differential	RENAULT	77 03 087 146	050560	07011906	
115414	27,95	70,00	10,00	ASW RD	ACM	115413	differential	RENAULT	77 03 087 148		12015423	
94507	30,00	40,00	7,00	AS RD W	FPM	47982	camshaft	RENAULT	77 03 087 189	508489	12014403	81-15512-50
115415	85,00	105,00	8,00	AS W LD	ACM/FPM	109243	camshaft	RENAULT	77 03 087 190	508462	12015424	81-23708-50
115417	22,00	45,00	7,00	AS W LD	FPM	112607	camshaft	RENAULT	77 03 087 191	508608	20015738	81-26392-10
115416	25,00	42,00	7,00	AS W RD	FPM	112618	camshaft	RENAULT	77 03 087 192	508544	12015425	81-26389-30
117123	40,00	54,00	6,80	A W LD	FPM	117121	differential	RENAULT	77 03 087 209		20026877	
117126	27,94	56,00	8,00	AS W RD	FPM	117124	differential	RENAULT	77 03 087 210		20026878	
115353	85,00	105,00	11/6,8	AS LD	FPM	115352	crankshaft	RENAULT	77 03 087 224	711720	20018246	81-34417-00
114587	42,00	62,00	10,00	AS RD	ACM	35050	crankshaft	RENAULT	79 10 247 576	040363	12013896	
93398	120,65	152,40	22,22	SP	NBR	84681	axle	ROR	210 206 63			
95254	117,00	152,00	15,00	SP	NBR	94016	axle	ROR	210 206 65			
93390	117,48	152,36	22,00	KA	NBR	113977	axe	ROR	212 003 21		12018944	
94017	117,07	152,40	24,21	KA	NBR	94017	wheel hub	ROR	212 003 21			
82176	100,00	135,00	13/15	SP	NBR	81333	wheel hub	ROR	212 201 58		12017274	
114641	122,00	152,00	13,00	SP	NBR	94012	axle	ROR	990 420 15			
119288	30,00	40,00	7,00	AS W LD	FPM	112608	crankshaft	Rover	LUC100290		19027629	
113942	68,00	90,00	10,00	A	NBR	4546	crankshaft	RVI	0024 411 680	251720	12011012	
113941	100,00	120,00	12,00	AS W WD	NBR	111803	wheel hub	RVI	0024 472 286		07016683	
111757	85,00	110,00	6,00	BS OF SF	NBR	111756	differential	RVI	0024 472 624		01026300	
113959	120,00	150,00	15/12	AW/BS	NBR	84716	wheel hub	RVI	0024 472 709		01016917	
119068	90,00	110,00	12,00	A	NBR	50350		RVI	50 0000 0813		12011043	
114492	70,00	90,00	12/8	AS	NBR	114432	gearbox	RVI	5000 132 770		12011015	
117413	145,00	175,00	13,00	C	NBR	6729	rear axle	RVI	5000 281 014		12011407	
114512	110,00	140,00	17,00	KA	NBR	114455		RVI	5000 288 417			
117334	22,00	35,00	7,00	A	NBR	17557	crankshaft	RVI	5000 294 202		12010836	
113940	53,00	68,00	10,00	A	NBR	18390	crankshaft	RVI	5000 350 272		12010980	
113961	69,00	80,00	4,2/8,5	B OF SF	NBR	113960	rear axle	RVI	5000 387 566		12017138	
113963	44,00	85,00	10,00	A W WD blue	NBR	113962	rear axle	RVI	5000 391 891		07016685	
113965	80,00	100,00	10,00	AS W WD blue	NBR	113964	wheel hub	RVI	5000 392 404		07016735	
113967	75,00	90,00	8,00	A W WD	NBR	113966	wheel hub	RVI	5000 515 606		07016734	
113958	95,00	110,00	10,00	B WD blue	NBR	113957	wheel hub	RVI	5000 545 227		07013389	

dph-no	dim 1	dim 2	dim 3	Style	Material	dph oil seal no.	Application	Type	OEM-NO	Elring	Corteco	Reinz
113970	53,00	97,00	8,00	A W WD	NBR	113969	wheel hub	RVI	5000 546 916		07016775	
113972	140,00	160,00	13,00	AS W WD blue	NBR	113971	wheel hub	RVI	5000 654 396		20016681	
110540	120,00	160,00	15,00	AS WD	NBR	110539	wheel hub	RVI	5000 671 980		01016684	
113939	110,00	130,00	12,00	A	NBR	18860	wheel hub	RVI	5000 675 159		07016686	
113580	85,00	130	17/26	AS RD W SP	FPM/ACM	113571	crankshaft	RVI	5000 675 975		07016736	
111760	45,00	55,00	7,00	B WD	NBR	93224	crankshaft	RVI	5000 787 085		07002931	
113943	85,00	110,00	13,00	AS	NBR	18731	wheel hub	RVI	5000 788 400	300896		
111645	120,00	160,00	15,00	AS WD	NBR	110539	wheel hub	RVI	5000 788 490		01016684	
111754	57,00	74,00	12,50	B OF SF	FPM	111753	crankshaft	RVI	5000 790 853		07016381	
114511	98,00	115,00	6,5/13	AS W SP	NBR	114454	crankshaft	RVI	5000 804 940			
114493	100,00	120,00	10/9,5	AS2 W WD	FPM	114437	wheel hub	RVI	5000 807 810		01035692	
117252	95,30	114,29	11,88	BS WD LA	FPM	96979	gearbox	RVI	5000 814 109		12012235	
117360	25,00	32,00	5,00	B OF	NBR	48055	gearbox	RVI	5000 815 354		01002919	
117341	48,00	65,00	10,00	AS W RD	AEM/PTFE	114341	gearbox	RVI	5000 819 719		20016209	
114494	75,00	102,00	14,00	BS SP combi	NBR	114442	gearbox	RVI	5000 819 970			
114495	140,00	170,00	17,00	KA	FPM	114449	wheel hub	RVI	5000 823 891		12016451	
117338	25,00	35,00	7,00	AS	NBR	84590	injection pump	RVI	5000 823 986			
114508	117,48	152,40	25,40	KB	NBR	93393	wheel hub	RVI	5001 835 188			
113974	140,00	160,00	13,00	AS W WD blue	NBR	113971	wheel hub	RVI	5001 858 475		20016681	
111646	120,00	140,00	13,5/15,5	AS WD W SF	FPM/ACM	113975	wheel hub	RVI	5003 087 034		20016794	
117362	50,00	58,00	4,00	BO	NBR	22997	stub axle	RVI	5003 087 037		01012190	
111759	100,00	125,00	13,00	AS W WD	NBR	111758	crankshaft	RVI	5010 067 534		12014731	
113938	75,00	95,00	10,00	A	NBR	6638	crankshaft	RVI	5010 216 049		01030103	
114496	65,00	85,00	9,5/10	A WD F	NBR	113534	wheel hub	RVI	5010 216 174		01029810	
116997	95,00	120,00	13,00	BS LD	FPM	82399	crankshaft	RVI	5010 242 655		12015304	
114497	85,00	110,00	12,00	AW/BS RD	FPM	114429	differential	RVI	5010 319 134		01020413	
111755	85,00	110,00	12,00	AW/BS LD	FPM	111813		RVI	5010 319 135		01026331	
113976	75,00	95,00	10/9,50	B WD	FPM	4380	differential	RVI	5010 319 684		01019480	
113978	117,48	152,36	22,00	KA	NBR	113977	crankshaft	RVI	5010 368 901		12018944	
120457	30,00	37,00	4,00	AO	NBR	21609	gearbox	RVI	5010 439 193		12015561	
117361	50,00	58,00	4,00	BO	NBR	22997	stub axle	RVI	5010 439 195		01012190	
114498	100,00	130,00	12,50	AW/BS SP	FPM	114441	wheel hub	RVI	5010 443 187		12033886	
113980	120,00	150,00	15,00	AW/BS	FPM	113979	wheel hub	RVI	5010 443 189		01030102	
113572	85,00	130	17/26	AS RD W SP	FPM/ACM	113571	crankshaft	RVI	5010 534 001		07016736	
113579	85,00	130	17/26	AS RD W SP	FPM/ACM	113571	crankshaft	RVI	5010 534 863		07016736	

dph-no	dim 1	dim 2	dim 3	Style	Material	dph oil seal no.	Application	Type	OEM-NO	Elring	Corteco	Reinz
113937	58,00	80,00	10,00	A	NBR	18473	wheel hub	RVI	5516 015 596		12010995	
113982	80,00	95,00	8,00	A W WD	NBR	113981	wheel hub	RVI	5516 015 803		07013486	
113936	85,00	110,00	13,00	A	NBR	19167	wheel hub	RVI	7701 003 394		12013388	
118605	25,00	42,00	7,00	AS W RD	FPM	112618	camshaft	RVI	7703 087 192		12015425	
84264	21,00	35,00	10,00	AS W RD	ACM	84263		SAAB	87 108 81			
84262	22,00	32,00	7,00	AS W RD	ACM	84261	gearbox	SAAB	87 220 01			
114567	35,00	47,00	8/7	AS W WD	ACM	113716	wheel hub	SAAB	87 31 804		01018330	
115503	48,00	66,65	8,00	AW/BS RD	FPM	98046	crankshaft	SAAB	91 73 576		20026265	
109704	88,00	108,00	11,10	AW/BS LD	FPM	80639	crankshaft	SAAB	91 74 202		12014402	
109703	88,00	108,00	11,10	AW/BS LD	FPM	80639	crankshaft	SAAB	91 75 902	330959		81-25452-10
37650	48,00	66,65	10,00	AS RD W	MVQ	37651	crankshaft	SAAB	93 09 204	330965		81-25789-00
37649	88,00	108,00	12,00	AS LD W	NBR	37653	crankshaft	SAAB	93 50 158			
93432	142,00	180/185,00	7,50	B SP	NBR	93431	crankshaft	SAF	4 266 0028 01		01017375	
109678	120,00	140,00	13,00	C	NBR	94015	crankshaft	SAF	4 373 0003 00	042935	12012064	
94368	140,00	165,00	12,00	C	NBR	68849	crankshaft	SAF	4 373 0004 00			
82503	160,00	180,00	15,00	CS	NBR	81835	crankshaft	SAF	4 373 0005 00		01003556	
94369	180,00	200,00	15,00	CS	NBR	70806	crankshaft	SAF	4 373 0006 00		12011379	
93558	125,00	150,00	13,00	CS	NBR	81334	crankshaft	SAF	4 373 0008 00		12011419	
84397	140,00	160,00	13,00	C	NBR	93856	crankshaft	SAF	4 373 0010 00		12017296	
114658	150,00	170,00	15,00	CS	NBR	61249	crankshaft	SAF	4 373 0014 00		12011423	
93394	117,48	152,40	25,40	KB	NBR	93393	wheel hub	SAF	4 373 0035 01			
113536	126,85	157,00	8,70	SP	FPM	113535	crankshaft	SAF	4 373 0041 01		01029721	
113546	126,85	153/157,00	8,80	A SP	NBR	113544	crankshaft	SAF	4 373 0042 01		01029720	
109596	142,15	175,50	11,40	AS SP	FPM	110394	axle	SAF	4 373 0043 00			
109598	142,15	175,50	11,40	AS SP	NBR	110392	axle	SAF	4 373 0044 00			
109531	54,10	70/74	7,5/11	BA OF	NBR	111355	crankshaft	SCANIA	1 100 645		12013506	
112584	50,00	70,00	9,00	A/B WD	FPM	112583	crankshaft	SCANIA	1 104 500		01019463	
82871	30,00	47,00	10/7	AS W WD F	ACM	82870	crankshaft	SCANIA	1 109 869		12014828	
104542	35,00	62,00	7,00	AS W WD	ACM	84536	camshaft	SCANIA	1 109 870	580202	12014830	81-26592-10
112656	42,00	72,00	8,00	AS W WD	ACM	112655	crankshaft	SCANIA	1 109 871		12014829	
112581	40,00	60,00	9/8	A W WD	FPM	112582	crankshaft	SCANIA	1 120 864		01033144	
118917	35,00	52,00	10,00	AS W WD	ACM	112653	crankshaft	SCANIA	1 122 619		01026707	
112654	35,00	52,00	10,00	AS W WD	ACM	112653	crankshaft	SCANIA	1 122 620		01026707	
116175	145,00	170,00	14,5/18	KA/BS SP	FPM	96110	wheel hub	SCANIA	1 303 673			
114755	75,00	100,00	10/13	KA	NBR	114389	wheel hub	SCANIA	1 313 719		12017173	

dph-no	dim 1	dim 2	dim 3	Style	Material	dph oil seal no.	Application	Type	OEM-NO	Elring	Corteco	Reinz
96716	55,00	75,00	9,00	BS RD	FPM	96717	gearbox	SCANIA	1 318 388		12015253	
114675	50,00	60,00	8,00	BS	NBR	114344	crankshaft	SCANIA	1 324 870		01030356	
114499	130,00	170,00	17,00	KA SP	FPM	96427	crankshaft	SCANIA	1 329 839			
93430	125,00	150,00	14,00	AS SP	NBR	93429	crankshaft	SCANIA	1 334 535	457590	12016695	
84730	80,00	100,00	10/8	BS WD LA	ACM	112617	crankshaft	SCANIA	1 335 243		12015254	
114443	140,00	165,00	15,00	SP	NBR/MVQ	118919	crankshaft	SCANIA	1 336 001			
93428						93428	with Polrad	SCANIA	1 342 363			
114500	149,90	176,00	16,00	KA	NBR	104925	wheel hub	SCANIA	1 342 708		19026423	
109530	45,00	60,00	6,5/8	B OF SF	NBR	112601	steering	SCANIA	1 343 372		01026542	
95457	44,45	60,00	7,00	BS SP	NBR	95642	crankshaft	SCANIA	1 345 278		01031705	
96311	44,45	60,00	10/15	SP	NBR	95643	brake camshaft	SCANIA	1 345 279		01034657	
95458	38,10	50,00	6,80	AS W SP	NBR	95644	brake camshaft	SCANIA	1 349 089		01031712	
119277	56,00	72,00	7,00	A SP	NBR	109213	steering	SCANIA	1 357 268			
96111	145,00	170,00	14,5/18	KA BS SP	FPM	96110	wheel hub	SCANIA	1 363 673			
82497	158,00	188,00	14,5/18	KA	FPM	109377	crankshaft	SCANIA	1 363 674	919888	12017426	
111452	145,00	175,00	13,00	AS LD SF	PTFE	111451	crankshaft	SCANIA	1 375 002	090510	15026917	81-35996-00
119278	56,00	72,00	7,00	A SP	NBR	109213	crankshaft	SCANIA	1 379 477			
95649	84,93	104,77	18,26	SP1 RD	FPM/ACM	112634	crankshaft	SCANIA	1 383 129		12018653	
98061	84,93	104,77	18,26	SP1 RD	FPM/ACM	112634	crankshaft	SCANIA	1 386 594	222630	12018653	
115847	120,00	140,00	12,00	AS W RD	PTFE/AEM	116003	crankshaft	SCANIA	1 392 708	152320		81-35997-00
111372	85,00	105,00	18,00	FPM	SP LD	111372	front axle	SCANIA	1 393 331			
98060	84,93	104,77	12/18,26	SP2 LD	FPM/ACM	112636	front axle	SCANIA	1 393 331	222640	12018654	
109529	56,00	72,00	7,00	A SP	NBR	109213	steering	SCANIA	1 395 999			
112266	142,00	170,00	15/16	KA	NBR	112790	wheel hub	SCANIA	1 409 889	222620	12020496	
112282	75,00	100,00	10/13	KA	NBR	114389	wheel hub	SCANIA	1 409 890	222610	12017173	
114501	130,00	170,00	18/20	KA	FPM	114448	crankshaft	SCANIA	1 415 136		12019945	
114503	72,00	90,00	12/9,5	A/B WD	NBR	96429	crankshaft	SCANIA	1 426 876		01016959	
111453	145,00	175,00	13,00	AS LD SF	PTFE	111451	crankshaft	SCANIA	1 433 183	090510	15026917	81-35996-00
116057	145,00	175,00	13,00	A/B W blue	NBR	82427	rear axle	SCANIA	1 433 186			
111330	84,93	104,77	12/18,26	SP2 LD	FPM/ACM	112636	crankshaft	SCANIA	1 502 384	222640	12018654	
112585	84,93	104,77	18,26	SP1 RD	FPM/ACM	112634	crankshaft	SCANIA	1 502 385	222630	12018653	
114504	158,00	188,00	16,00	KA	FPM	114460	wheel hub	SCANIA	1 528 043			
68810	45,00	60,00	7,00	A	NBR	70213	crankshaft	SCANIA	120 828	040606	12010950	
70446	80,00	100,00	10,00	A green	NBR	4306	front-/rear axle	SCANIA	120 979	546038	12011026	
70447	136,52	161,92	12,70	A	NBR	24777	rear axle	SCANIA	121 257		20016795	

dph-no	dim 1	dim 2	dim 3	Style	Material	dph oil seal no.	Application	Type	OEM-NO	Elring	Corteco	Reinz
69284	38,00	50,00	7,00	A	NBR	70214	crankshaft	SCANIA	123 102		12010923	
94928	80,00	100,00	13,00	BS blue	NBR	94928	rear axle	SCANIA	124 268	042463		
34426	80,00	100,00	13/15	CS WD SF	ACM	118176	rear axle	SCANIA	124 268		12015254	
110713	70,00	90,00	10,00	A LD	NBR	61487	front&rear axle	SCANIA	125 766			
110712	158,00	188,00	14,5/18	KA	FPM	109377	crankshaft	SCANIA	130 934-2			
82323	35,00	58,00	10,00	A	NBR	17960	crankshaft	SCANIA	132 672		12010911	
70449	28,00	38,00	7,00	A	NBR	17693	steering	SCANIA	136 106		12000129	
70450	30,00	47,00	7,00	AS	NBR	17741	transfer gearbox	SCANIA	139 023		12000480	
114563	30,00	52,00	10,00	A	NBR	17768	wheel hub	SCANIA	139 038		12010887	
70451	50,00	70,00	10,00	A	NBR	18328	crankshaft	SCANIA	14 107		12010969	
70452	30,00	55,00	10,00	A	NBR	17780	crankshaft	SCANIA	144 116		12010889	
34422	150,81	177,80	12,70	AS blue	NBR	84589	wheel hub	SCANIA	159 496	325503	12011092	
116194	30,00	47,00	10,00	A	NBR	17745	crankshaft	SCANIA	170 072			
118339	30,00	52,00	8,00	A	NBR	17766	injection	SCANIA	170 074			
116195	30,00	42,00	6/6,8	BABSL WD	NBR	84542	injection pump	SCANIA	170 075			
70455	42,00	72,00	8,00	AS W WD	ACM	112655	crankshaft	SCANIA	170 226		12014829	
70457	25,00	47,00	10,00	A	NBR	68544	crankshaft	SCANIA	170 761	038326	12010858	81-20553-10
34423	117,47	142,87	12,70	A blue	NBR	84532	crankshaft	SCANIA	173 320	325511	12011073	
70461	130,00	160,00	13,00	B	NBR	45614	rear axle	SCANIA	178 866	281972		
34424	150,81	117,80	12,70	AS blue	NBR	84589	wheel hub	SCANIA	179 360			
70465	25,00	35,00	7,00	AS	NBR	84590	injection pump	SCANIA	192 600	038075	12011122	
116196	26,00	37,00	7/8	AS V W	NBR	47945	steering	SCANIA	195 532			
81457	42,00	62,00	6,00	AS W	NBR	81456	rear axle	SCANIA	202 288			
95850	17,00	28,00	7,00	AS	NBR	17448	differential	SCANIA	210 648		12011112	
114525	20,00	40,00	7/8	AS	NBR	47959	crankshaft	SCANIA	210 743		12011118	
70473	25,00	35,00	8,00	A D	NBR	47303	steering	SCANIA	211 337	008427		
84539	50,00	68,00	8,00	A	NBR	84538	crankshaft	SCANIA	214 005		12010967	
34425	90,00	110,00	14,00	BS	NBR	81437	differential	SCANIA	214 008		12002888	
70474	80,00	100,00	10,00	B	NBR	18683	gearbox	SCANIA	216 608	042390		
110716	80,00	100,00	10,00	A green	NBR	4306	front-/rear axle	SCANIA	227 138			
116197	35,00	62,00	7,00	AS W WD	ACM	84536	injection	SCANIA	228 109	269700		
34428	130,00	160,00	15,00	AS W LD	MVQ	48518	crankshaft	SCANIA	231 938	587079	12013893	81-25014-10
114596	45,00	65,00	8,00	A	NBR	18232	crankshaft	SCANIA	244 249		12010955	
114592	45,00	55,00	7,00	B RD	ACM	93690	crankshaft	SCANIA	244 710		01026396	
70475	25,00	35,00	7,00	B	NBR	4378	gearbox	SCANIA	254 635	038083	12014487	

dph-no	dim 1	dim 2	dim 3	Style	Material	dph oil seal no.	Application	Type	OEM-NO	Elring	Corteco	Reinz
84543	30,00	42,00	6/6,8	BABSL WD	NBR	84542	injection pump	SCANIA	280 759		11014231	
34427	145,00	170,00	15/20	B SP	NBR	50174	rear axle	SCANIA	291 076	586838	12011388	
70480	155,00	180,00	24/29	B SP	FPM	50175	wheel hub	SCANIA	291 463	598925	12011917	
84541	75,00	90,00	10/11	BABSL	NBR	84540	crankshaft	SCANIA	294 275		12001716	
70481	137,00	161,92	15/12	BS WD LA SP	NBR	61646	crankshaft	SCANIA	297 991	586803	12012241	
61643	113,00	136,00	10,90	A SP	NBR	61642	rear axle	SCANIA	297 999	586781	12014734	
61645	110,00	140,00	12/21	NBR SP	NBR	82425	front wheel hub	SCANIA	300 278		01002741	
34435	80,00	110,00	10,00	A	NBR	18694	crankshaft	SCANIA	304 552		12011029	
98517	161,92	187,32	12,70	A	NBR	24964	reductor hub	SCANIA	309 113		12012234	
84537	35,00	62,00	7,00	AS W WD F	ACM	84536	injection pump	SCANIA	310 951		12014830	
114589	42,00	72,00	8,00	AS W WD	ACM	112655	crankshaft	SCANIA	310 953		12014829	81-25136-10
70483	45,00	65,00	9,00	BS RD LA	ACM	81126	gearbox	SCANIA	314 063	325562	12011970	
114553	26,00	37,00	7/8	AS V W	NBR	47945	steering	SCANIA	318 996	006408	12014826	81-35069-00
70484	35,00	52,00	10,00	A	NBR	17934	gearbox	SCANIA	32 201	258407	12010899	
70485	120,65	146,05	12,70	A	NBR	84534	front axle	SCANIA	32 898			
81460	25,00	35,00	7,00	BAB SL	NBR	4468	transfer gearbox	SCANIA	329 638		12014616	
70486	70,00	100,00	12,00	A	NBR	84533	crankshaft	SCANIA	33 326	325473	12011017	
3888	75,00	100,00	10,00	A blue	NBR	84535	gearbox	SCANIA	33 352	530107	12011021	
34421	80,00	100,00	12,00	BS RD LA	FPM	34420	crankshaft	SCANIA	338 643	527823	12011821	81-25013-20
109532	56,00	70,00	6,00	A SP	NBR	109212		SCANIA	347 468			
114313	125,00	160,00	17,00	KA SP	FPM	81798	axle	SCANIA	350 984		01015140	
69285	130,00	160,00	15,00	AW/BS LD	FPM	93307	crankshaft	SCANIA	366 303	587070	12013893	81-25014-10
112590	105,00	140,00	13/12	CS WD	NBR	112591	crankshaft	SCANIA	368 542		01034659	
111285	80,00	100,00	13,00	AS SP	PTFE	111403	crankshaft	SCANIA	369 477	382100	20017234	81-25013-30
111272	130,00	160,00	13,00	SP	PTFE	111404	crankshaft	SCANIA	369 478	354390	20017235	81-25014-20
61647	137,00	161,92	15/12	BS WD LA SP	NBR	61646	rear axle	SCANIA	370 074		12012241	
50176	155,00	180,00	24/29	B SP	FPM	50175	wheel hub	SCANIA	370 075	598925	12011917	
50177	145,00	170,00	15/20	B SP	NBR	50174	crankshaft	SCANIA	370 076	586838	12011388	
111548	145,00	170,00	15/12	B SP	FPM	111230	crankshaft	SCANIA	370 076 FPM			
61649	125,00	160,00	15,00	AS W	NBR	61648	crankshaft	SCANIA	375 086		12014463	
61651	110,00	140,00	15,00	AS W SP	NBR	61650	front axle	SCANIA	375 087		12014464	
95648	70,00	85,00	8,00	BS WD blue	NBR	95646	crankshaft	SCANIA	378 480			
114697	55,00	75,00	9,00	BS RD	FPM	96717	crankshaft	SCANIA	378 620		12015253	
70525	85,00	105,00	13,00	BS	NBR	32425	differential	SCANIA	386 901	096067		
70527	72,00	105,00	13,00	BS	NBR	4767	front&rear axle	SCANIA	386 967	008559		

dph-no	dim 1	dim 2	dim 3	Style	Material	dph oil seal no.	Application	Type	OEM-NO	Elring	Corteco	Reinz
70528	72,00	105,00	13,00	C WD	FPM	48048	transfer gearbox	SCANIA	386 968	008745	12014743	
81462	45,00	65,00	10/8	A/BS LD	FPM	81461	gearbox	SCANIA	388 528		12015765	
36169	80,00	100,00	13,00	BS blue	NBR	94928	crankshaft	SCANIA	388 728		12015254	
117770	145,00	170,00	15/20	B SP	NBR	50174	rear axle	SCANIA	550 174			
70547	22,00	32,00	8,00	AS	NBR	32076	Injection	SCANIA	837 613	711500		
80799	190,00	220,00	15,00	BS	NBR	80796	crankshaft	STEYR	90 003 070 012		01017008	
81295	190,00	220,00	15,00	BS WD	MVQ	81295	crankshaft	STEYR	90 003 070 012			
80800	190,00	220,00	15,00	B WD	FPM	80797	crankshaft	STEYR	90 003 070 013		01017007	
81380	28,00	40,00	7,00	AS W WD	MVQ	84575	crankshaft	STEYR	90 003 070 014		11029673	
93567	85,00	105,00	8,00	AS	NBR	84573	crankshaft	STEYR	90 003 070 027			
95295	25,00	37,00	7,00	AS W	ACM	95321	crankshaft	STEYR	90 003 074 306			
81735	55,00	70,00	12,00	A W	MVQ	81299	crankshaft	STEYR	90 003 074 340			
95152	60,00	80,00	11/13	AS W RD	ACM	95543	crankshaft	STEYR	90 003 074 347			
95151	60,00	80,00	11/13	AS W LD	ACM	95926	crankshaft	STEYR	90 003 074 348			
81131	115,00	140,00	12,00	AS W LD	MVQ	81129	crankshaft	STEYR	90 003 074 377			
81736	140,00	160,00	13,00	AS W	MVQ	81300	crankshaft	STEYR	90 003 074 387			
95153	110,00	145,00	13,00	BS LA LD	FPM	95925	crankshaft	STEYR	90 003 074 476			
116222	100,00	125,00	13,00	BS LA RD	FPM	95927	crankshaft	STEYR	90 003 074 478			
95294	125,00	150,00	12/14	AS W	NBR	95318	crankshaft	STEYR	90 003 074 484			
81738	85,00	105,00	10,00	CS	NBR	70803	crankshaft	STEYR	90 003 078 775			
81132	95,00	115,00	12,00	AS W RD	MVQ	81130	crankshaft	STEYR	90 003 078 807			
109444	100,00	125,00	13,00	AS W RD	FPM	109443	crankshaft	STEYR	90 003 078 831			
95150	110,00	145,00	13,00	BS LA LD	FPM	95925	crankshaft	STEYR	90 003 078 871			
120452	135,00	160,00	12,00	A/BS LD	NBR	96476	crankshaft	Steyr	90003 070 056			
	50,00	67,00	5,5/7,5	special	NBR	113989	wheel bearing	SUBARU	28015-AA011			
114702	56,00	72,30	8/12	SP	NBR	114033	wheel bearing	SUBARU	28015-AA021			
114032	56,00	72,20	8/10	SP	NBR	114031	wheel bearing	SUZUKI	09283-56002			
120456	50,00	68,00	8,50	A SP	NBR	81051	wheel hub	Toyota	903115005		19017041	
96931	101,00	114,00	10,00	BS	NBR	96930		Toyota	90033-19001			
96927	40,00	46,00	12,8/17,5	SPSC5	NBR	96926	wheel hub	Toyota	90310-40001		19018296	
96933	41,00	47,00	17,00	SPSC5	NBR	96932	wheel hub	Toyota	90310-41001		19026768	
120047	38,00	50,00	10,50	AS RD	FPM	120046	camshaft	Toyota	90311 38034			
96923	75,50	108,00	10/19,5	SPT4A29	NBR	96922	wheel hub	Toyota	90311-75003		19016652	
120086	80,00	100,00	8,50	AS LD	MVQ	120087	crankshaft	Toyota	90311-80007		19015091	81-53319-00
96929	88,00	105,00	13,00	CS	NBR	96928	wheel hub	Toyota	90311-88102		19018295	

									OEM-NO			
dph-no	dim 1	dim 2	dim 3	Style	Material	dph oil seal no.	Application	Type	OEM-NO	Elring	Corteco	Reinz
93828	110,00	146,00	24,00	SP	NBR	93827	axle	TRAILOR	6502085P			
119335	111,12	146,05	14,28	SP	NBR	97195	axle	TRAILOR	6502085T		12017210	
94318	100,00	120,00	12,00	A/BS WD	FPM	95865	crankshaft	VOLVO	1 070 379		12017395	
111456	100,00	113,60	6,50		NBR	111456	wheel accessory kit	VOLVO	1 076 656-6			
46716	110,00	140,00	12/19	SP	FPM	117745	front wheel hub	VOLVO	1 089 552	522911	12014742	81-35101-00
95873	85,00	105,00	12/10	B	NBR	95872	gearbox	VOLVO	1 139 840			
95875	85,00	105,00	10,00	B LD	FPM	4047	gearbox	VOLVO	1 190 064			81-35297-00
4480	52,00	68,00	10,00	AS RD W	MVQ	16052	crankshaft	VOLVO	1 276 425	465194	15012624	
114720	64,90	90,00	9,5/10	A/B RD felt	FPM	112981	gearbox	VOLVO	1 521 431	435820	01030098	
37599	140,00	164,00	20/23,50	SP	FPM	50173	rear axle	VOLVO	1 522 372	922277	12014656	
80493	50,00	65,00	8,00	B WD	FPM	80492	rear axle	VOLVO	1 522 373	597015	20019176	81-35124-00
69293	80,00	150,00	12/20	SP RD LA	FPM	69292	differential carrier	VOLVO	1 522 894	588008	12014744	81-35129-00
116232	80,00	130,20	12/20	SP RD LA	ACM	69294	automatic gearbox	VOLVO	1 522 895			
36626	80,00	130,20	12/20	RD LA SP	FPM	82426	automatic gearbox	VOLVO	1 522 895	588016	12014745	81-35131-00
95892	150,00	180,00	17,5/16	BS2 WD	FPM	95891	crankshaft	VOLVO	1 522 896	590738	12011324	
95354	90,00	145,00	10/15	A/B SP	FPM	94049	differential	VOLVO	1 523 239	435180	12015693	81-35132-00
112428	90,00	151,00	11/17	BS2 LA RD SP	FPM	119116	differential	VOLVO	1 523 634			
95894	150,00	180,00	10,00	BS2 SP	STEEL	95893	crankshaft	VOLVO	1 524 281		12016843	
112976	70,00	102,00	14,50	AS W LD SP	FPM	112987	crankshaft	VOLVO	1 524 838		12013988	
114689	54,50	80,00	8,00	BS WD	FPM	114355	crankshaft	VOLVO	1 526 008		01030336	
95878	55,00	75,00	8,00	B RD	FPM	36792	crankshaft	VOLVO	1 526 688			81-35152-00
95880	105,00	130,00	12/9,5	AW/BS LD	ACM	95476	crankshaft	VOLVO	1 526 828			
108817	180,00	205,00	15,00	A/BS W	FPM	108818	crankshaft	VOLVO	1 543 896		12015255	81-35206-00
117539	80,00	100,00	10,00	A/BS RD	ACM	120475	retainer water pump	VOLVO	1 543 908-6		12017220	
114597	45,00	65,00	8,00	A/BS RD	ACM	114337	crankshaft	VOLVO	1 543 936		12017221	
114565	34,90	62,00	8,00	A/BS LD	ACM	114332	injection pump	VOLVO	1 546 221	760240	12017218	81-33677-00
114594	45,00	62,00	8,00	AW/BS RD	ACM	114336	crankshaft	VOLVO	1 546 480	390010	01030097	
112979	136,00	159,00	13,00	A/B RD	PTFE/ACM	112984		VOLVO	1 549 398			
114650	133,35	155,60	14,00	B WD	NBR	36376	wheel hub	VOLVO	1 577 624		12011387	
46810	110,00	140,00	12/21	SP	NBR	82425	front axle	VOLVO	1 587 792	522910	12013870	
114664	164,4/168	188 / 190,00	30 / 32	BS WD	ACM	50796	wheel hub	VOLVO	1 591 903	522880	12014351	
94314	100,00	140,00	15,5/20	KA	FPM	113947	wheel hub	VOLVO	1 593 459		01015141	
94319	145,00	175,00	17,00	SP	FPM	95207	wheel hub	VOLVO	1 594 257			81-35301-00
46725	77,00	98,4/103,00	6,3/19,3	A OF SF	NBR	82906	wheel hub	VOLVO	1 610 078		12013127	
37598	164,4/168	188 / 190,00	30 / 32	BS WD	ACM	50796	wheel hub	VOLVO	1 610 765			

dph-no	dim 1	dim 2	dim 3	Style	Material	dph oil seal no.	Application	Type	OEM-NO	Elring	Corteco	Reinz
98342	167,00	188/192,50	30 / 32	BS2 WD SP	FPM	98433	wheel hub	VOLVO	1 610 765	693162		81-35134-00
112427	90,00	145,00	10,00	A/BS LD	FPM	112716	automatic gearbox	VOLVO	1 652 776	435340	12016675	81-35136-00
114646	130,00	160,00	15,00	AW/BS RD	FPM	97703	crankshaft	VOLVO	1 668 341		01031088	
94048	90,00	110,00	11/9,5	AW/BS LD	FPM	94047	crankshaft	VOLVO	1 669 618		01026642	
116234	140,00	164,00	20/23,50	SP	FPM	50173	rear axle	VOLVO	1 672 249	222757	12016932	
115687	90,00	145,00	10/15	A/B SP	FPM	94049	differential	VOLVO	1 673 701	435180	01034125	
108783	20,00	40,00	8,00	A SP	FPM	84162		VOLVO	1 695 593			81-35302-00
114637	120,00	140,00	13,00	CS	NBR	51716	front & rear axle	VOLVO	1 696 066		12012064	81-35104-00
114513	120,00	146,00	19,56	SP	NBR	114457		VOLVO	1 699 171			
114505	110,00	140,00	17,00	KA	NBR	114455		VOLVO	1 699 341			
70269	87,17	117,47	11,90	SP	NBR	118913		VOLVO	191 160-1			
119405	25,00	35,00	7,00	AS	NBR	84590	injection pump	VOLVO	192 600		12011122	
70272	70,00	90,00	10,00	B	NBR	18612	injection pump	VOLVO	192 600-5	246891		
111427	125,00	148,00	9/7	A/BS SP	FPM	111426		VOLVO	20 399 560			
114666	180,00	205,00	15,00	AS W LD	PTFE	114424	crankshaft	VOLVO	20 441 481		20031153	
112980	64,90	90,00	9,5/10	A/B RD felt	FPM	112981	gearbox	VOLVO	20 476 025		01030098	
111429	125,00	148,30	8,1/9,3	KA/BS SP	FPM	111428		VOLVO	20 518 642			
118665	110,23	145,00	10/12	SP	FPM	116318	crankshaft FM9	VOLVO	20 832 385		01031695	
50742	130,00	160,00	15,00	AS W LD	MVQ	48518		VOLVO	231 938			
81848	25,00	35,00	7,00	AS	NBR	84590	injection pump	VOLVO	240 022	038075	12011122	
98639	16,00	30,00	7,00	AS	NBR	19108		VOLVO	241 625			
33551	42,00	62,00	10,00	AS RD	ACM	35050	crankshaft	VOLVO	247 576		12013896	81-21001-10
81330	117,48	152,36	22,00	KA	NBR	113977	STEMCO 2110	VOLVO	247 597		12018944	
119739	26,00	34,00	4,5/7	AS1 SF	NBR	116002		VOLVO	263 448			
35804	64,90	90,00	10,00	BS RD LA F	FPM	35885		VOLVO	267 268	587958	12013360	
35805	80,00	100,00	10,00	BS LD LA	FPM	35886		VOLVO	267 269	587966	12013361	81-35169-00
70270	60,00	80,00	8/9,5	BS RD	FPM	81817	gearbox	VOLVO	267 316		12013864	
109851						109851	wheel accessory kit	VOLVO	3 095 043-0			
93291	145,00	175,00	19,00	SP	NBR	93292		VOLVO	3 123 521			
114774	85,00	130,00	17/26	AS RD W SP	FPM/ACM	113571	crankshaft	VOLVO	3 152 027		07016736	
112986	90,00	151,00	11/17	BS2 LA RD SP	FPM	119116	differential	VOLVO	3 192 069			
112983	90,00	151,00	11/14,5	A/BS RD SP	FPM	119114	differential	VOLVO	3 192 615			
4293	30,00	47,00	7,00	A SP	NBR	6763	camshaft	VOLVO	3 514 943			81-33636-00
113644	30,00	47,00	7,00	A WD	FPM	113644	camshaft	VOLVO	3 514 943	135150	01500581	
80047	25,00	35,00	8,00	A D	NBR	47303	steering	VOLVO	338 425-2	008427		

dph-no	dim 1	dim 2	dim 3	Style	Material	dph oil seal no.	Application	Type	OEM-NO	Elring	Corteco	Reinz
36627	26,00	37,00	7/8	AS V W	NBR	47945	steering	VOLVO	341 050	006408	12014826	81-35069-00
114706	60,00	74,00	10/8	AS W LD	FPM	113749	gearbox	VOLVO	346 682-8		12013365	
96085	10,00	15,00	3,00	B OF	NBR	47952	front axle	VOLVO	346 822-0	010804	01002259	
37061	29,00	50,00	10/7	AW/BS LD	ACM	82254	injection pump	VOLVO	424 580-9	755087	12014476	
97594	130,00	160,00	15,00	AW/BS LD	FPM	93307	crankshaft	VOLVO	424 763			
110473	85,73	114,45	14,29	AS W RD	MVQ	15250	crankshaft	VOLVO	424 983-5			
37211	85,73	114,33	13/9,5	A/BS RD W	FPM	81284	crankshaft	VOLVO	424 983-5	570495	12013988	81-25952-20
15252	155,00	180,00	15,00	A/BS LD W	FPM	81702	crankshaft	VOLVO	469 336-2	760315	12015806	81-25934-00
15253	85,73	114,45	14,29	AS W RD	MVQ	15250	crankshaft	VOLVO	469 507-8			
81284	85,73	114,33	13/9,5	A/BS RD W	FPM	81284	crankshaft	VOLVO	469 507-8		12013988	
36300	76,20	101,60	11,90	A/BS RD felt	FPM	94792	crankshaft	VOLVO	471 055-4		12014191	
80733	76,20	101,60	11,90	A RD	MVQ	80733	crankshaft	VOLVO	471 055-4			
49099	127,00	150,00	12,00	A/BS LD	FPM	94791	crankshaft	VOLVO	471 056-2		12013863	
115988	127,00	150,00	12,00	A LD	MVQ	50795	crankshaft	VOLVO	471 056-2	518360		
82787	76,20	101,60	11,90	A RD	MVQ	80733	crankshaft	VOLVO	477 118-4			
110485	76,20	101,60	11,90	A/BS RD VL	FPM	94792	crankshaft	VOLVO	477 118-4	754669	01016760	81-31168-00
36586	127,00	150,00	12,00	A LD	MVQ	50795	crankshaft	VOLVO	477 119-2			
110486	127,00	150,00	12,00	A/BS LD	FPM	94791	crankshaft	VOLVO	477 119-2	518361	12013863	81-26294-10
114707	60,00	74,00	10/8	AS W LD	FPM	113749	gearbox	VOLVO	6 770 964-2		12013365	
94315	135,00	165,00	17,00	SP	NBR	95388	crankshaft	VOLVO	6 771 541-7			
114721	65,00	85,00	13,00	AW/BS LD	FPM	114374	gearbox	VOLVO	6 797 452-7		12014424	
114607	48,00	65,00	10,00	B	NBR	81637	gearbox	VOLVO	6 857 279-1	040991	12011331	
95881	48,00	69,00	10,00	B RD	FPM	47988	gearbox	VOLVO	6 876 126-1		12011306	81-35078-00
108799	48,00	65,00	10,00	B	NBR	81637	gearbox	VOLVO	6 876 127-9	040991	12011331	
114737	70,00	90,00	10,00	AS W LD	FPM	47944	gearbox	VOLVO	6 876 131-1		12014736	
114733	70,00	90,00	10,00	AS	NBR	18611	gearbox	VOLVO	6 876 132-9		12011015	
95884	25,00	35,00	7,00	B	NBR	4378	gearbox	VOLVO	6 876 142-8			
119406	25,00	35,00	7,00	B	NBR	4378	gearbox	VOLVO	6 876 348-1	038083	12014616	
119864	47,62	80,26	6,8/13,3	A SP W RD	FPM	95622	differential	VOLVO	6 877 226-8		01031231	
114718	63,50	102,50	6,6/14,8	AS W WD SF	FPM	114367	crankshaft	VOLVO	6 877 944-6		01030337	
112977	150,00	180,00	15,00	A/B W LD	PTFE/ACM	112978		VOLVO	8 148 259	515800		
36318	155,00	180,00	15,00	A/BS LD W	FPM	81702	crankshaft	VOLVO	821 755-6	760315	12015806	81-25934-00
69289	63,50	110,00	12,00	BS LD F	FPM	69288		VOLVO	943 250-1			
110723	80,00	100,00	10,00	BS LD LA	FPM	35886	PB 269	VOLVO	943 704-7	587966	12013361	81-35169-00
94046	26,30	36,20	7,30	AS	NBR	94045		VOLVO	943 741-9	246905	01027966	

dph-no	dim 1	dim 2	dim 3	Style	Material	dph oil seal no.	Application	Type	OEM-NO	Elring	Corteco	Reinz
119892						119892	wheel accessory kit	VOLVO	944 664-2			
80881	148,00	168/170,00	32,00	B WD F	NBR	80880	rear axle	VOLVO	944 665-9	522864	12011389	81-35113-00
84628	164,4/168	188 / 190,00	30 /32	BS WD	ACM	50796	wheel hub	VOLVO	944 666-7	522880	12014351	
36375	133,30	155,60	14,00	B WD	NBR	36376	wheel hub	VOLVO	944 667-5	522856	12011387	81-35111-00
61171	126,50	148,00	14,70		metal	61171	rear axle	VOLVO	944 670-9			
94316	126,75	168,00	15,00	C SP	NBR	119900	front & rear axle	VOLVO	944 671-7			
51729	180,00	224,00	12,00	BO SP	NBR	51729	balance arm bogie	VOLVO	945 538-7			
80013	152,40	120,65	13/12	SP	NBR	80012	front & rear axle	VOLVO	946 026-2	694088		
81414	125,00	150,00	13,00	BS	NBR	18911	wheel hub	VOLVO	946 093-2	108626	12011367	
114759	80,00	95,00	8,00	A W WD	NBR	113981	wheel accessory kit	VOLVO	947 269-7	043737	07013486	
108798	85,00	110,00	13/9,5	A	NBR	81336	wheel accessory kit	VOLVO	947 270-5	300896	12013388	
119891	95,00	110,00	10	B WD	NBR	113957	wheel hub	VOLVO	947 271-3		07013389	
108800	15,00	21,00	5,00	BS	NBR	37114	gearbox	VOLVO	947 705	327298	01019151	81-24010-00
59232	80,00	110,05	12,00	BS LD	FPM	95248	differential	VOLVO	948 448-6		12013871	81-35141-00
69291	90,00	125,25	10,00	BS RD LA	FPM	69290	rear axle	VOLVO	948 642-8	587991	12014746	81-35142-00
94036	65,00	80,00	8,00	B RD LA	FPM	119374	crankshaft	VOLVO	948 826-3		01026644	
69527	44,00	58,00	7,00	B	NBR	80466		VOLVO	949 573			
94044	15,00	35,00	7,00	A W	NBR	94043		VOLVO	958 811-2		12010796	
93784	38,00	52,00	7,00	A	NBR	18031		VOLVO	958 861-7			
70020	80,00	100,00	10,00	B	NBR	18683	gearbox	VOLVO	959 042-3		01002942	
82324	100,00	120,00	12,00	AS	NBR	19863	wheel accessory kit	VOLVO	968 012-5		12011209	
94317	110,00	130,00	12,00	AS	NBR	19879	crankshaft	VOLVO	968 013-3		12017368	
110158						110158	water pump	VOLVO	978 293-9			
120053	90,00	125,00	12,00	AS W LD	FPM	120051	gearbox	VOLVO	1 662 026		20034608	
82481	50,00	68,00	10,00	A/BS W RD	FPM	82470	crankshaft	VOLVO	8 414 241-3		12013865	81-16737-20
33549	80,00	100,00	13,00	A/BS LD W	MVQ	37509	crankshaft	VOLVO PC	1 218 027		19030094	81-18304-00
33552	42,00	62,00	10,00	AS RD	ACM	35050	crankshaft	VOLVO PC	1 218 034	040363	12013896	
48936	26,00	43,00	7,00	A W RD	FPM	48935	crankshaft	VOLVO PC	1 218 239		20025648	
114578	39,40	52,00	8,00	AS W LD	ACM	113713	transmission, output	VOLVO PC	1 233 756		01030125	
4277	85,00	105,00	12,00	A/BS LD W	FPM	61492	crankshaft	VOLVO PC	1 257 049	342092	12012347	
51384	35,00	48,00	10,00	A/BS W RD	FPM	81442	crankshaft	VOLVO PC	1 257 113	294357	12010739	81-24292-10
113715	35,00	48,00	10,00	AS W RD	FPM	113715	crankshaft front	VOLVO PC	1 257 113			
114570	35,00	48,00	10,00	AS W RD	ACM	51382	crankshaft	VOLVO PC	1 257 113			
35613	92,00	110,00	10,00	AW LD	MVQ	16051	crankshaft	VOLVO PC	1 266 604		12013897	
33553	52,00	68,00	10,00	AS RD W	MVQ	16052	crankshaft	VOLVO PC	1 276 424	465194	15012624	81-25587-00

									OEM-NO			
dph-no	dim 1	dim 2	dim 3	Style	Material	dph oil seal no.	Application	Type	OEM-NO	Elring	Corteco	Reinz
33550	35,00	47,00	7,00	AW RD	FPM/ACM	112614	crankshaft	VOLVO PC	1 306 333		12013859	
114569	35,00	47,00	7,00	AS RD	MVQ	37506	crankshaft	VOLVO PC	1 306 333	336998		81-25582-00
119851	28,00	40,00	8,00	B RD SP	NBR	113726	transmission, input	VOLVO PC	1 377 748			
98331	22,23	35,15	9,50	AS	FPM	81507	gearbox	VOLVO PC	1 518 399			
95883	25,00	49,70	10,5/15	AS W	FPM	81444	gearbox	VOLVO PC	1 526 817			81-35308-00
83884	80,00	100,00	13,00	A/BS W LD	MVQ	37509	crankshaft	VOLVO PC	3 267 244-6		19030094	
61492	85,00	105,00	12,00	A/BS LD W	FPM	61492	crankshaft	VOLVO PC	3 287 542	342092	12012347	81-36788-00
83885	85,00	105,00	8,00	AS W LD	ACM/FPM	109243	crankshaft	VOLVO PC	3 287 542-9	508462		81-23708-50
48921	25,00	42,00	8,00	A RD	MVQ	48919	camshaft	VOLVO PC	3 287 556-9			
112618	25,00	42,00	7,00	AS W RD	FPM	112618	camshaft	VOLVO PC	3 287 556-9	508544		81-26389-30
48920	22,00	45,00	8,00	A LD	MVQ	48918	camshaft	VOLVO PC	3 344 397-9			81-15512-30
94989	30,00	54,00	15/19,30	AS LD SP	FPM	113724	camshaft	VOLVO PC	3 507 309	393880	15029743	81-35989-00
120386	145,00	175,00	15,00	AW/BS RD	FPM	120442	crankshaft	VOLVO PC	3 825 169	559030		
69287	50,00	72,00	8/10	AS V	NBR	47950	steering	VOLVO PC	346 381-7	006432		
33548	92,00	110,00	10,00	AS LD W	MVQ	16051	crankshaft	VOLVO PC	430 118-0	044598	12013897	81-25583-00
114683	52,00	68,00	10,00	AS RD W	MVQ	16052	crankshaft	VOLVO PC	430 132		15012624	
114632	110,00	130,00	12,00	AW/BS	FPM	113950	crankshaft	VOLVO PC	6 773 195-0			
114668	48,00	65,00	10,00	AW/BS RD	FPM	36203	crankshaft	VOLVO PC	6 797 454-3		12012045	
4292	92,00	110,00	7,00	AS LD W	FPM	49103	crankshaft	VOLVO PC	6 842 093-4	044590	12017124	
80737	44,45	57,15	6,75	AS RD	ACM	80736	crankshaft	VOLVO PC	6 842 272			
108806	44,45	57,15	6,75	AS RD	FPM	108806	crankshaft	VOLVO PC	6 842 272	135180	15018287	81-33634-00
115506	35,00	47,00	6,00	AS RD	FPM	113719	crankshaft front	VOLVO PC	6 842 273	336999	12015674	
115406	97,00	110,00	8,00	A LD felt	FPM	113718	crankshaft	VOLVO PC	6 842 274	135190		
114584	40,00	63,00	8,70	A SP	FPM	113721	automatic gearbox	VOLVO PC	6 843 112		19033885	
114577	39,00	80,00	13,3/15,6	B SP	MVQ	113714		VOLVO PC	9 143 317			
114579	39,40	65,00	10,00	A/BS LD	ACM	113725	transfer gearbox	VOLVO PC	9 183 891		01034110	
95574	97,00	110,00	8,00	A LD felt	FPM	113718	crankshaft	VOLVO PC	9 458 178	135190	15510087	
110092	75,00	100,00	12,00	AS W	NBR	113611	crankshaft	VOLVO PC	968 844-1		12002219	
80579	45,00	68/72,20	19,50	SP	MVQ	80578	gearbox automatic	VW	001 301 083	043958		
34917	15,00	24,00	7,00	AS blue	NBR	97768	gearbox	VW	001 301 227		12000444	81-15293-10
81846	15,00	24,00	7,00	AS	NBR	97768	gearbox	VW	001 301 227 D		12000044	
35084	42,00	72,00	10,00	AS	NBR	19614	gearbox	VW	002 301 189			
37513	42,00	67,00	17,60	AS WD	NBR	37512	gearbox	VW	002 301 189 C	045322		
95663	42,00	55,00	7,00	A W RD	MVQ	96335	gearbox automatic	VW	003 519 089 D	225614		
98612	36,00	60,00	10,00	AS W WD	NBR	98611		VW	010 409 255 B			

dph-no	dim 1	dim 2	dim 3	Style	Material	dph oil seal no.	Application	Type	OEM-NO	Elring	Corteco	Reinz
96053	38,00	52,00	7,00	A	FPM	20567	gearbox automatic	VW	010 409 529 C			
96052	42,00	58/60,00	19,5/7	B SP RD	MVQ	96050	gearbox	VW	010 409 568 A	249173		
111524	16,00	24,00	6/6,5	AS	NBR	48059	gearbox	VW	012 301 457 C		01031067	
70571	20,00	35,00	7/10	AS RD	ACM	70816	gearbox	VW	014 311 113 A	091626		
112748	40,00	52,00	9,00	AS W WD	ACM	70817	gearbox	VW	014 409 399 B		12010684	
4056	40,00	52,00	9,00	AS W WD	ACM	70817	gearbox	VW	014 409 399 D	094358	12010684	
83005	40,00	65,00	10,00	AS blue	NBR	18118	transmission shaft	VW	015 301 227 A			
111526	25,00	40,00	8,00	AS RD	ACM	111525	gearbox	VW	016 311 113 B		12016989	
61261	45,00	60,00	8,00	AS W WD	ACM	61260	gearbox	VW	018 409 399	063665	12017270	
111626	40,00	52,00	7,00	AS W RD	FPM	111625	gearbox	VW	018 409 399 B			
118608	11,75	22,00	12,00	SP	ACM	109065	gearbox	VW	01J321182		01026312	
51950	18,00	27,00	5/8	AS OF	NBR	51949	gearbox	VW	020 141 733	244082	01026910	
96330	36,00	58,00	15,00	AS2 WD W	NBR	96329	gearbox	VW	020 301 189 F	525359		
81089	50,00	65,20	10,00	AS W WD	ACM	104440	gearbox	VW	020 301 189 H	527858	12016928	
95505	50,00	65,20	6,5/7,5	SP AS W WD	ACM	95508	gearbox	VW	020 301 189 L		01033845	
111232	50,00	65,20	10,00	AS W WD	ACM	104440	gearbox	VW	020 301 189 N	527858	12016928	
104441	50,00	65,20	10,00	AS W WD	ACM	104440	gearbox	VW	020 301 189 T	527858	12016928	
34982	18,00	30,00	7/8	AS green	NBR	4536	gearbox	VW	020 301 227			
51951	18,00	30,00	7/8	AS	NBR	4536	gearbox	VW	020 301 227 C			
95238	18,00	30,00	6,4/8,1	AS W SP	NBR	95237	gearbox	VW	020 301 227 D		01019317	
51953	8,00	14,00	4,00	B	FPM	51952	gearbox	VW	020 311 108 A	758876	01020437	
37344	21,90	40,00	8,00	AS RD	ACM	37343	gearbox	VW	020 311 113	244040		81-23807-00
35455	23,90	40,00	8,00	AS RD	ACM	96872	gearbox	VW	020 311 113 B		12016924	
112376	21,90	40,00	8,00	AS RD	ACM	37343	gearbox	VW	020 311 113 D			81-23807-00
35671	75,00	95,00	12,00	AW LD	FPM	61491	crankshaft	VW	021 105 245 B			
6703	75,00	95,00	12,00	AW LD	MVQ	34962	crankshaft	VW	021 105 245 C			
35051	42,00	62,00	10,00	AS RD	ACM	35050	crankshaft	VW	021 105 247 A	040363	12013896	81-21001-10
35511	42,00	62,00	10,00	AS RD	ACM	35050	crankshaft	VW	021 105 247 B	040363	12013896	81-21001-10
111623	35,00	48,00	10,00	AS W SP	ACM/PTFE	111624	crankshaft	VW	022 103 085			81-36791-00
32341	48,00	68,00	10,00	AS RD	ACM	32706	crankshaft	VW	025 105 247			
32231	48,00	68,00	10,00	AS RD	ACM	32706	crankshaft	VW	025 105 247 A			
70819	85,00	105,00	11,00	AS W LD	FPM	84358	crankshaft	VW	026 103 051 A			
61492	85,00	105,00	12,00	A/BS LD W	FPM	61492	crankshaft	VW	026 103 051 A		12015256	
6512	32,00	47,00	10,00	W WD	FPM/ACM	97600	crankshaft	VW	026 103 085	325155	12012709	
112747	32,00	47,00	10,00	AS W WD	FPM/ACM	97600	crankshaft	VW	026 103 085 D		12012709	

									OEM-NO			
dph-no	dim 1	dim 2	dim 3	Style	Material	dph oil seal no.	Application	Type	OEM-NO	Elring	Corteco	Reinz
111513	32,00	47,00	10,00	AS W WD	FPM/ACM	97600	crankshaft	VW	026 103 085 F		12012709	
34961	48,00	68,00	10,00	AS RD brown	FPM	34960	crankshaft	VW	026 105 247 A			
81598	85,00	105,00	11,00	M6 SP KA	PTFE	109159	crankshaft	VW	028 103 171		20033462	
96899	85,00	105,00	11,00	M6 SP KA	PTFE	109159	crankshaft	VW	028 103 171 B	804850	20033462	
23052	75,00	95,00	12,00	AW LD	FPM	61491	crankshaft	VW	029 105 245			
35053	75,00	95,00	10,00	AW LD	FPM/ACM	95002	crankshaft	VW	029 105 245 B	326798	20019852	
81455	40,00	60,00	10/12	AS W WD	NBR	81454	differential	VW	02A 301 189		12015556	
111514	15,00	24,00	6/6,5	A DUO	ACM	111515	automatic gearbox	VW	02A 301 227 C		01030118	
51383	35,00	48,00	10,00	A/BS W RD	FPM	81442	crankshaft	VW	034 115 147 A		12010739	
96384	27,00	42,00	8,00	A/BS RD	FPM	96387	camshaft	VW	036 103 085 A	076110	12018554	81-34226-00
113602	32,00	42,00	8,00	AS RD W	FPM	113932	camshaft	VW	036 103 085 C		20019960	
109070	32,00	42,00	8,00	AS RD W	FPM	113932	camshaft	VW	036 103 085 H	158060	20019960	
98140	32,00	47,00	10,00	AS RD SP	PTFE/ACM	112807	crankshaft	VW	038 103 085 C	129780	20026413	
112729	35,00	48,00	10,00	AS W SP	AEM/PTFE	111624	crankshaft	VW	038 103 085 E	155560	20026412	81-34366-00
111184	85,00	105,00	12,00	AS W LD	FPM/ACM	114899	crankshaft	VW	049 103 051 D	315494		
83914	35,00	48,00	10,00	AS W RD	ACM	51382	crankshaft	VW	054 115 147			
51382	35,00	48,00	10,00	AS W RD	ACM	51382	crankshaft	VW	054 115 147 B			
109220	35,00	48,00	10,00	A/BS W RD	FPM	81442	crankshaft	VW	054 115 147 B	475961	12010739	81-24292-10
3915	82,00	105,00	12,00	AS W LD	FPM	3914	crankshaft	VW	056 103 051 A	232300	12013892	
22982	85,00	105,00	12,00	A/BS LD W	FPM	61492	crankshaft	VW	056 103 051 D		12012347	
35634	85,00	105,00	12,00	A/BS LD W	FPM	61492	crankshaft	VW	056 103 051G			
34694	32,00	47,00	10,00	AS W WD	FPM/ACM	97600	crankshaft	VW	056 103 085	325155	12012709	
35510	32,00	47,00	10,00	AS W WD	FPM/ACM	97600	crankshaft	VW	056 103 085 B		12012709	
34632	85,00	105,00	12,00	A/BS LD W	FPM	61492	crankshaft	VW	068 103 051			
69585	85,00	105,00	11,00	AS W LD	FPM	84358	crankshaft	VW	068 103 051 G		12015256	81-35353-00
96323	85,00	105,00	11,00	AS W LD	MVQ	96323	crankshaft	VW	068 103 051 G			
35013	32,00	47,00	10,00	AS W WD	FPM	37434	crankshaft	VW	068 103 085	325155	12012709	81-19299-10
34885	32,00	47,00	10,00	AS W WD	FPM/ACM	97600	crankshaft	VW	068 103 085 A			
35801	32,00	47,00	10,00	AS W WD	ACM	61485	crankshaft	VW	068 103 085 ACM			
111205	32,00	47,00	10,00	AS W WD	FPM/ACM	97600	crankshaft	VW	068 103 085 E			
37152	85,00	105,00	11,00	M7 SP KA	PTFE	81520	crankshaft	VW	068 103 171 G-F	804850	20033462	
68844	35,00	48,00	10,00	AS W RD	ACM	51382	crankshaft	VW	069 115 147 C			
81442	35,00	48,00	10,00	A/BS W RD	FPM	81442	crankshaft	VW	069 115 147 C	294357	12010739	81-24292-10
95849	85,00	105,00	11,00	M7 SP KA	PTFE	81520	crankshaft	VW	06A 103 171 A/B			
110504	85,00	131/152	15,70	KA	PTFE	120201	crankshaft	VW	06A 103 171 B / D	012370	20020383	81-90010-00

dph-no	dim 1	dim 2	dim 3	Style	Material	dph oil seal no.	Application	Type	OEM-NO	Elring	Corteco	Reinz
116336	42,00	55,00	7,00	AW/BS RD	PTFE/ACM	116335	crankshaft	VW	06C 103 085			81-36024-00
111528	23,00	35,00	6,50	A W RD	ACM	111527	crankshaft	VW	084 311 113 A		12015553	
111530	48,00	62,00	7,00	AS WD	ACM	111529	differential	VW	084 409 189 B		12015555	
111532	57,00	71,00	7/6,5	AS WD	ACM	111531	differential	VW	084 409 189 C		12015557	
111516	15,00	24,00	7,00	AS	NBR	97768	gearbox	VW	085 301 227	279528		
80789	21,80	35,00	7,00	AS	NBR	80788	gearbox	VW	085 311 113		12015554	
98617	22,00	31,00	7,00	B	FPM	98614	gearbox	VW	087 409 133 C			
98616	28,00	40,00	7,00	B	FPM	98615	gearbox	VW	087 409 485 B			
84231	45,00	62,00	6,5/7	A/B WD	ACM	84230	gearbox	VW	087 409 529 B	091511	01026543	
70818	45,00	60,00	8,00	AS WD W	ACM	61260	gearbox	VW	088 409 399 D	063665		
98618	26,00	38,00	6,00	BS	NBR	98613	gearbox	VW	089 409 085 C			
37511	45,00	72,00	15,00	AS2W WD	NBR	37510	differential	VW	091 301 189 A	277525		
94690	45,00	72,00	15,00	AS2W WD	NBR	37510	differential	VW	091 301 189 C			
116105	34,00	52,00	7,00	A W	ACM	104443	gearbox	VW	096 323 862		01025670	
34918	60,00	80,00	10,00	A blue	NBR	81629	crankshaft	VW	111 105 245	041491		
69197	40,00	62,00	11,50	A	NBR	18112	wheel hub	VW	111 405 641 A			
97947	40,00	52/56,00	9,00	AS SF	NBR	97945	wheel hub	VW	111 405 641 C			
4582	70,00	90,00	10,00	A LD	NBR	61487	crankshaft	VW	113 105 245 F			
81485	70,00	90,00	10,00	A LD	ACM	81487	crankshaft	VW	113 105 245 F	042102	12001482	81-15287-30
97605	70,00	90,00	10,00	A LD F	MVQ	97640	crankshaft	VW	113 105 245 FD			81-15287-40
34202	70,00	90,00	10,00	AS LD	MVQ	50760	crankshaft	VW	113 105 245 FS	513326		81-15287-10
35509	70,00	90,00	10,00	A LD	NBR	61487	crankshaft	VW	113 105 245 G			
97172	35,00	60,00	15,00	AS	NBR	97174	crankshaft	VW	113 301 189 F	277517		
104113	15,00	24,00	7,00	AS	NBR	97768	crankshaft	VW	113 301 225			
110482	22,20	40,00	12/17	AS RD	ACM	4042	gearbox	VW	113 311 113	043605		
4041	22,00	40,00	12/17	AS RD	ACM	4042	gearbox	VW	113 311 113 A	043605		
48450	18,00	30,00	7,00	A	NBR	17480	steering	VW	113 415 277			
48451	28,00	40,00	7,00	A	NBR	17697	crankshaft	VW	113 415 297	164500		
81493	44,50	62,00	8,00	AS2	NBR	81492	rear axle	VW	113 501 315 G			
50868	44,50	62,00	10/7	AS2 WD	NBR	95590	rear axle	VW	113 501 315 H	042803	12011164	
48452	50,00	65,00	8,00	A	NBR	97943	wheel hub	VW	211 405 641 D	412104	12010966	
4067	48,00	72,00	7/9	AS2	NBR	50513	wheel hub	VW	211 501 317	394009	12013894	
50514	48,00	72,00	7/9	AS2	NBR	50513	wheel hub	VW	211 501 317 C			
4144	55,00	68,00	8,50	AS W	NBR	36319	front axle	VW	251 407 641 A	284459	12013929	
36327	55,00	68,00	8,50	AS W	NBR	36319	front axle	VW	251 407 641 B			

dph-no	dim 1	dim 2	dim 3	Style	Material	dph oil seal no.	Application	Type	OEM-NO	Elring	Corteco	Reinz
4072	55,00	68,00	8,50	AS W	NBR	36319	front axle	VW	251 407 641 C			
48162	55,00	68,00	8,50	AS W	NBR	36319	front axle	VW	281 407 641 C	284459	12013929	
32985	24,00	32,00	7,00	BS	NBR	32247	crankshaft	VW	281 415 749			
111534	65,00	85,00	10,00	AS2 WD	NBR	111533	wheel hub	VW	291 501 317	046094	12013927	
115679	60,00	73,00	11/7	AW/BS WD	FPM	115992	wheel hub	VW	2D0 501 317 A		01016963	
35480	38,00	52/58,00	8,50	AS BD	NBR	37098	front axle	VW	311 405 641 B		12011154	
82745	38,00	52/58,00	8,50	AS BD	NBR	37098	front axle	VW	311 405 641A			
34919	16,00	24,00	7,00	A	NBR	17428	transfer gearbox	VW	311 415 277	044008		
48453	24,00	37,00	7,00	A	NBR	17587	crankshaft	VW	311 415 297			
4060	40,00	52/58,00	7,5/6	AS WD W	NBR	37227	rear axle	VW	321 501 641	045772	12011153	
37226	40,00	52/58,00	7,5/6	AS WD W	NBR	37227	rear axle	VW	357 501 641 B			
50682	45,00	62,00	10,00	CS	NBR	18227	wheel hub	VW	477 405 641	043451		
94547	40,00	52,00	7/6	A/BS	NBR	94546	wheel hub	VW	8A0 501 641 A		12018360	
96041	40,00	52,00	7/12,7	SP	NBR	96065	wheel hub	VW	8DO 501 641 A		01019205	
84768	10,00	15,00	3,00	B OF	NBR	47952	crankshaft	ZF	0634 300 185		01002259	
82325	25,00	35,00	7,00	B	NBR	4378	gearbox	ZF	0634 300 302		12014616	
114582	40,00	52,00	7,00	B	NBR	68543	gearbox	ZF	0634 300 466			
84769	48,00	65,00	10,00	B	NBR	81637	gearbox	ZF	0634 300 540			
111794	85,00	105,00	10,00	B	NBR	50341	gearbox	ZF	0634 300 712		12011340	
97892	20,00	32,00	7,00	BABSL	NBR	51422	steering	ZF	0634 302 121	037524		
113769	22,00	35,00	7,00	A	NBR	17557	crankshaft	ZF	0634 302 143			
114726	65,00	90,00	13,00	BS	NBR	48401	differential	ZF	0634 309 092		12015935	
97891	80,00	100,00	13,00	BS	NBR	94928	rear axle	ZF	0634 309 104			
114771	85,00	105,00	13,00	BS	NBR	32425	differential	ZF	0634 309 106		12011359	
114680	50,00	70,00	10,00	C	FPM	114347	crankshaft	ZF	0634 310 209		01029755	
114725	65,00	90,00	10,00	A	FPM	20627	crankshaft	ZF	0634 310 675		01029759	
109229	40,00	58,00	10,00	AS WD SF	FPM	109411	crankshaft	ZF	0731 319 330			
35178	60,00	74,00	10,00	B	NBR	35179	crankshaft	ZF	0734 300 002			
114708	60,00	74,00	10/8	AS W LD	FPM	113749	gearbox	ZF	0734 300 024		12013365	
97376	90,00	110,00	15,00	AW/BD	FPM	96082	crankshaft	ZF	0734 300 046			
109257	48,00	65,00	10,00	B	NBR	81637	gearbox	ZF	0734 300 087		12011331	
95874	85,00	105,00	12/10	B	NBR	95872	gearbox	ZF	0734 300 093		12011341	
109256	55,00	75,00	10/8	B	NBR	50345	gearbox	ZF	0734 300 094		12011333	
94631	60,00	85,00	10,00	B	NBR	47466	gearbox	ZF	0734 300 100		12011334	
84767	70,00	90,00	10,00	B	NBR	18612	crankshaft	ZF	0734 300 104		01029757	

dph-no	dim 1	dim 2	dim 3	Style	Material	dph oil seal no.	Application	Type	OEM-NO	Elring	Corteco	Reinz
96325	72,00	90,00	12/9,5	A/B WD	NBR	96429	crankshaft	ZF	0734 300 185		01016959	
113930	50,00	100,00	7,50	SP	ACM	113929	crankshaft	ZF	0734 307 287			
115634	136,80	165,00	13,00	KA	NBR	115632	crankshaft	ZF	0734 309 291		12019619	
119001	136,80	165,00	13,00	KA	NBR	115632	crankshaft	ZF	0734 309 422		12019619	
114651	135,00	165,00	12,00	A/BS WD	FPM	98291	crankshaft	ZF	0734 310 102			
112950	52,00	68,00	8,00	A/BS RD	FPM	96995	crankshaft	ZF	0734 310 104		12018806	
82326	48,00	69,00	10,00	B RD	FPM	47988	gearbox	ZF	0734 310 108		12011306	
95876	85,00	105,00	10,00	B LD	FPM	4047	gearbox	ZF	0734 310 109		12013757	
97374	48,00	75,00	8,00	B RD	FPM	4545	gearbox	ZF	0734 310 110		12011307	
95877	55,00	75,00	8,00	B RD	FPM	36792	gearbox	ZF	0734 310 111		12011308	
97375	90,00	110,00	15,00	AW/BD	FPM	96082	gearbox	ZF	0734 310 121			
94632	60,00	85,00	12,00	B RD	FPM	47991	gearbox	ZF	0734 310 122		12012578	
114628	105,00	130,00	12,00	A/BS LD	FPM	48035	crankshaft	ZF	0734 310 124		12013364	
114738	70,00	90,00	10,00	AS W LD	FPM	47944	gearbox	ZF	0734 310 128		12014736	
114619	100,00	120,00	10,00	A W LD	FPM	48007		ZF	0734 310 131		12013550	
97663	125,00	150,00	10,00	A/B W RD	FPM/ACM	97662	crankshaft	ZF	0734 310 165		20020422	
96326	130,00	170,00	17,00	KA	FPM	96427	wheel hub	ZF	0734 310 285			
116345	80,00	110,00	10,00	A W	FPM	116411	wheel hub	ZF	0734 310 333			
113620	10,00	15,00	5,00	B O	FPM	113619	crankshaft	ZF	0734 310 353		01030490	
113768	55,00	75,00	8,00	B RD	FPM	36792	gearbox	ZF	0734 310 386		12011308	
116558	55,00	75,00	8,00	B RD	FPM	36792	gearbox	ZF	0734 310 387			
120054	90,00	125,00	12,00	AS W LD	FPM	120051	gearbox	ZF	0734 319 052		20034608	
96428	90,00	120,00	12/9,5	BS RD	FPM	94933	gearbox	ZF	0734 319 127		01026464	
114654	142,00	162,00	10/9,5	AS W RD	FPM	97820	crankshaft	ZF	0734 319 137		01029929	
96915	105,00	125,00	12/9,5	AW/BS LD SP	FPM	96914	gearbox	ZF	0734 319 459		01026691	
114916	85,00	110,00	10/14	A/B Duo	FPM	114400	crankshaft	ZF	0734 319 460		01029919	
95879	105,00	130,00	12/9,5	AW/BS LD	ACM	95476	gearbox	ZF	0734 319 551		01016923	
111627	40,00	52,00	7,00	AS W RD	FPM	111625	gearbox	ZF	0734 319 588			
114502	130,00	170,00	18/20	KA	FPM	114448	crankshaft	ZF	0734 319 610		12019945	
113752	60,00	74,00	10/8	AS W LD	FPM	113749	gearbox	ZF	0734 319 688			
113751	42,00	62,00	10/8	A W RD	FPM	113750	gearbox	ZF	0734 319 713			
82327	105,00	130,00	12,00	A	NBR	18844	crankshaft	ZF	0750 110 001		12011062	
94630	90,00	110,00	8,00	B	NBR	18752		ZF	0750 110 069			
82328	85,00	105,00	12,00	B	NBR	44329	gearbox	ZF	0750 110 074		12011341	
82329	48,00	75,00	8,00	B RD	FPM	4545	gearbox	ZF	0750 111 002		12011307	

dph-no	dim 1	dim 2	dim 3	Style	Material	dph oil seal no.	Application	Type	OEM-NO	Elring	Corteco	Reinz
82330	85,00	105,00	10,00	B LD	FPM	4047	gearbox	ZF	0750 111 004		01011312	
98174	142,00	162,00	10/9,5	AS W RD	FPM	97820	crankshaft	ZF	0750 111 077		01029929	
109722	90,00	120,00	13/9,5	A/BS WD	FPM	109726	crankshaft	ZF	0750 111 116		01029767	
113767	48,00	65,00	10,00	AW/BS RD	FPM	36203	gearbox	ZF	0750 111 149		20016209	
109721	75,00	100,00	10,00	BS RD	FPM	109725	gearbox	ZF	0750 111 231		20034262	
117350	100,00	140,00	15,00	A/BS WD W	FPM	84452	wheel hub	ZF	0750 111 328			
111750	105,00	130,00	12/9,5	AW/BS LD	ACM	95476	gearbox	ZF	0750 111 341		01016923	
113753	60,00	74,00	10/8	AS W LD	FPM	113749	gearbox	ZF	0750 111 469			
113754	42,00	62,00	10/8	A W RD	FPM	113750	gearbox	ZF	0750 111 476			
109216	25,00	40,00	15,00	SP	FPM	109216	gearbox	ZF	0750 112 131		01029609	
84570	18,00	30,00	7/8	AS	NBR	4536	crankshaft	ZF	0770 080 220			
84568	24,00	37,00	7,00	B	NBR	19306	crankshaft	ZF	0770 080 244			
84675	26,00	34,00	4,5/7	AS1 SF	NBR	116002	crankshaft	ZF	0770 080 252		01020066	
96969	20,00	30,00	7/8	AS W blue	NBR	96968	crankshaft	ZF	0770 080 256		12016820	
93747	24,00	37,00	7,00	A W	NBR	93746	crankshaft	ZF	0770 080 268			
96967	25,00	38,00	7,00	AW blue	NBR	96966	crankshaft	ZF	0770 080 286		12016917	
97101	19,05	30,00	7,00	A	MVQ	97100	crankshaft	ZF	0770 080 442		01026490	
96990	28,00	37,00	5,00	A W	NBR	96989	crankshaft	ZF	0770 080 457		01016891	
96108	50,00	72,00	8/10	AS V	NBR	47950	steering	ZF	0770 198 037			
93879	26,00	37,00	7/8	AS V W	NBR	47945	crankshaft	ZF	0770 198 103		12014826	
98406	26,00	37,00	7,91	A W SP	NBR	98405		ZF	0770 198 107			
109255	20,00	30,00	5/5,5	AS	NBR	93745	steering	ZF	0770 198 130			
117206	26,00	34,00	4,5/7	AS1 SF	NBR	116002	crankshaft	ZF	0770 198 134		01020066	
109254	26,00	35,00	7,00	A F	NBR	84567		ZF	7824 033 113			
93749	28,00	38,00	7,00	A SP	NBR	93748		ZF	7852 033 108		01015867	
114555	28,00	38,00	7,00	A SP	NBR	93748		ZF	7852 033 110		01015867	



Dimensions

Dimensions

dph-no	dim 1	dim 2	dim 3	Style	Material	dph oil seal no.	Application	Type	OEM-NO	Eling	Corteco	Reinz
97910	7,00	16,00	6,00	AS	NBR	97909		FORD	1 579 860			
33252	7,00	16,00	7,00	A	NBR	17345		BMW	11 31 1 256 860			
46909	7,00	16,00	7,00	A	NBR	17345		DB	001 997 8246			
33298	7,00	16,00	7,00	A	NBR	17345	crankshaft	FORD	1 463 342			
35204	7,00	16,00	7,00	B	NBR	35205	transmission	MAN	81 96501 0306			
33336	7,00	16,00	7,00	A	NBR	17345	gearbox	OPEL	724 876			
33260	8,00	14,00	4,00	B	NBR	33261	speedometer drive	BMW	23 12 1 490 192		01033871	
51953	8,00	14,00	4,00	B	FPM	51952	gearbox	VW	020 311 108 A	758876	01020437	
46884	8,00	16,00	7,00	A	NBR	17348	crankshaft	DB	000 997 4646		12010757	
46919	8,00	16,00	7,00	A	NBR	17348	crankshaft	DB	002 997 1246		12010757	
46873	8,00	16,00	7,00	A	NBR	17348	crankshaft	DB	003 997 1046			
95963	8,90	15,80	13,00	SP blue	NBR	104491	crankshaft	DB	008 997 9047		01026500	
47267	9,00	16,00	9/15	B	NBR	48047		DB	007 997 7346			
46980	10,00	15,00	3,00	B OF	NBR	47952	front axle	DB	003 997 9846	010804	01002259	81-25545-00
110728	10,00	15,00	3,00	B OF	NBR	47952	front axle	IVECO	112 2949		01002259	
114516	10,00	15,00	3,00	B OF	NBR	47952	front axle	MAN	06 56269 0479	010804	01002259	
114517	10,00	15,00	3,00	B OF	NBR	47952	front axle	MAN	06 56269 0527	010804	01002259	
96085	10,00	15,00	3,00	B OF	NBR	47952	front axle	VOLVO	346 822-0	010804	01002259	
84768	10,00	15,00	3,00	B OF	NBR	47952	crankshaft	ZF	0634 300 185		01002259	
113620	10,00	15,00	5,00	B O	FPM	113619	crankshaft	ZF	0734 310 353		01030490	
114518	10,00	16,00	6,00	B	NBR	37534	gearbox	DB	003 997 7946			
114519	10,00	16,00	6,00	B	NBR	37534	gearbox	DB	004 997 5546			
70578	10,00	16,00	6,00	B	NBR	37534	gearbox	DB	006 997 6146			
33263	10,00	18,00	5,00	A	NBR	19096		BMW	24 34 1 207 430			
112517	10,00	18,00	5,00	AS	NBR	112519	gearbox	BMW	24 52 7 509 500		01033982	
116035	10,00	18,00	6,00	A	NBR	17356	crankshaft	BMW	23 12 1 451 030	011304		
33259	10,00	18,00	6,00	A	NBR	17356	crankshaft	BMW	23 12 1 451 157	011304		
46851	10,00	19,00	7,00	B	NBR	17357	fuel pump	DB	000 997 1146			
35091	10,00	19,00	7,00	B	NBR	17357		MAN	06 56269 0001			
96954	10,00	20,00	7,50	A SP	NBR	96954		ZF				
35614	11,00	17,00	4,00	A	NBR	19101	injection pump	MAN	81 96501 0477			81-31533-00
33262	11,00	22,00	7,00	A	NBR	17366		BMW	24 34 1 203 237			
33264	11,00	22,00	7,00	A	NBR	17366		BMW	24 34 1 207 763			
118608	11,75	22,00	12,00	SP	ACM	109065	gearbox	VW	01J321182		01026312	
118609	12,00	16,00	3,00	A O W	NBR	113618	crankshaft	DEUTZ	103 2872		01032872	

dph-no	dim 1	dim 2	dim 3	Style	Material	dph oil seal no.	Application	Type	OEM-NO	Eling	Corteco	Reinz
82550	12,00	18,00	6,00	B	NBR	113655	gearbox automatic	DB	006 997 0147			
47534	12,00	20,00	5,00	B	NBR	19072		DB	003 997 8747			
47264	12,00	22,00	7,00	B	NBR	17372		DB	007 997 4946			
95010	12,50	20,00	5,00	A W WD	NBR	95010		VW				
111541	13,00	26,00	7,00	AS blue	NBR	19061	gearbox	OPEL	732 235			
119140	13,00	31,00	3,50	SP	NBR	119140						
46910	14,00	24,00	7,00	B	NBR	19033	gearbox	DB	001 997 8346	037109	01002369	
48065	14,00	24,00	7,00	B	NBR	19033		DB	003760 014200	037109		
47572	14,00	24,00	7,00	B	NBR	19033		DB	005 997 4247	037109		
69187	14,00	24,00	7,00	AS	NBR	43079		DB	007 997 4146			
117302	14,00	24,00	7,00	B	NBR	19033		MAN	06 56261 0804	037109		
35207	14,00	24,00	7,00	B	NBR	19033		MAN	81 96501 0313	037109		
33337	14,00	24,00	7,00	A	NBR	17391	crankshaft	OPEL	732 225		12010784	
33355	14,00	24,00	7,00	A	NBR	17391		PORSCHE	900 112 02950			
61262	14,00	26,00	7,00	B	NBR	61494		DB	007 997 5046			
37121	15,00	21,00	5,00	BS	NBR	37114	gearbox	BMW	23 11 1 204 223		01019151	81-24010-00
116030	15,00	21,00	5,00	BS	NBR	37114	gearbox	BMW	23 11 1 228 333			
116034	15,00	21,00	5,00	BS	NBR	37114	gearbox	BMW	23 12 1 222 677	327298		
98438	15,00	21,00	5,00	BS	NBR	37114	gearbox	BMW	23 12 1 282 394	327298		
108800	15,00	21,00	5,00	BS	NBR	37114	gearbox	VOLVO	947 705	327298	01019151	81-24010-00
33253	15,00	24,00	7,00	A	NBR	17403	differential	BMW	23 11 1 006 124			
33283	15,00	24,00	7,00	B	NBR	17404	manual gearbox	DB	001 997 2946	037133	12010790	
47308	15,00	24,00	7,00	B	NBR	17404	manual gearbox	DB	008 997 9846	037133	01002376	
33352	15,00	24,00	7,00	B	NBR	17404	manual gearbox	PORSCHE	900 112 00150	037133		
94832	15,00	24,00	7,00	A	FPM	20500		PORSCHE	999 113 18540	089613		
34917	15,00	24,00	7,00	AS blue	NBR	97768	gearbox	VW	001 301 227		12000444	81-15293-10
81846	15,00	24,00	7,00	AS	NBR	97768	gearbox	VW	001 301 227 D		12000044	
111516	15,00	24,00	7,00	AS	NBR	97768	gearbox	VW	085 301 227	279528		
104113	15,00	24,00	7,00	AS	NBR	97768	crankshaft	VW	113 301 225			
104556	15,00	24,00	7,00	A Duo	FPM	104556	steering	ZF			01030475	
108810	15,00	24,00	7,00	A/B Duo	NBR	108810	steering	ZF				
111514	15,00	24,00	6/6,5	A DUO	ACM	111515	automatic gearbox	VW	02A 301 227 C		01030118	
70569	15,00	32,00	7,00	A	NBR	70569	wheel hub	MF			12010795	
94044	15,00	35,00	7,00	A W	NBR	94043		VOLVO	958 811-2		12010796	
33257	16,00	24,00	7,00	A	NBR	17428	transfer gearbox	BMW	23 12 1 232 248			

Dimensions

Dimensions

dph-no	dim 1	dim 2	dim 3	Style	Material	dph oil seal no.	Application	Type	OEM-NO	Eling	Corteco	Reinz
34919	16,00	24,00	7,00	A	NBR	17428	transfer gearbox	VW	311 415 277	044008		
94562	16,00	24,00	6/6,5	AS	NBR	48059	fuel injection pump	BMW	23 12 1 451 156			
111524	16,00	24,00	6/6,5	AS	NBR	48059	gearbox	VW	012 301 457 C		01031067	
33258	16,00	26,00	7,00	A	NBR	19104		BMW	23 12 1 233 386			
94561	16,00	26,00	7,00	A	NBR	19104		BMW	23 12 1 338 740			
47006	16,00	26,00	7,00	A V	NBR	47958		DB	004 997 8346			
98639	16,00	30,00	7,00	AS	NBR	19108		VOLVO	241 625			
94663	16,00	35,00	10,00	B	NBR	94663						
97908	17,00	27,00	7,00	BS	NBR	97908						
48359	17,00	28,00	6,00	DFD	NBR	4491		DB	005 997 8047			
82808	17,00	28,00	6,00	B DUO	NBR	4491		DB	009 997 0047			
84619	17,00	28,00	7,00	B	NBR	37867		DAF	0110 732		12011351	
114521	17,00	28,00	7,00	AS	NBR	17448	crankshaft	DAF	0119 468	050300	12011112	
46889	17,00	28,00	7,00	AS	NBR	17448	crankshaft	DB	000 997 6546		12011112	
82809	17,00	28,00	7,00	B	NBR	37867	injection pump	DB	004 997 4947		01002391	
47007	17,00	28,00	7,00	A	NBR	17447	crankshaft	DB	004 997 8546	050300	01210807	
94633	17,00	28,00	7,00	B	NBR	37867		DB	005 997 9747			
119284	17,00	28,00	7,00	B RD	ACM	118614	gearbox	Fiat	4000 0090		12011426	
119285	17,00	28,00	7,00	B RD	ACM	118614	gearbox	Fiat	4000 1460		12011426	
112551	17,00	28,00	7,00	AS	NBR	17448	crankshaft	IVECO	128 8064		12011112	
114520	17,00	28,00	7,00	A	NBR	17447	crankshaft	MAN	06 56260 1106	050300	12010807	
37868	17,00	28,00	7,00	B	NBR	37867	crankshaft	OPEL	819 830		12015322	
119286	17,00	28,00	7,00	B RD	ACM	118614	gearbox	RENAULT	77 00 522 671		12011426	
119287	17,00	28,00	7,00	B RD	ACM	118614	gearbox	RENAULT	77 03 087 085		12011426	
95850	17,00	28,00	7,00	AS	NBR	17448	differential	SCANIA	210 648		12011112	
47261	17,00	28,00	8,00	B DUO	NBR	20245		DB	007 997 3846			
46866	17,00	35,00	7,00	A	NBR	93613	water pump	DB	002 997 8446	054003	12010810	81-17193-00
47561	17,00	35,00	7,00	A	NBR	93613	water pump	DB	005 997 0147	054003	12010810	
114522	17,00	37,00	10,00	A	NBR	68546		DEUTZ	121 6338	055506		
114523	18,00	25,00	6,00	B	NBR	21472	crankshaft	DEUTZ	415 8766		01030093	
51950	18,00	27,00	5/8	AS OF	NBR	51949	gearbox	VW	020 141 733	244082	01026910	
33285	18,00	28,00	7,00	A	NBR	17479	crankshaft	DB	001 997 6446		12010816	
94337	18,00	28,00	6,5/8	BS SF	NBR	94337						
33266	18,00	30,00	7,00	A	NBR	17480	steering	BMW	32 11 1 110 269			
37119	18,00	30,00	7,00	AS	NBR	19193		BMW	32 13 1 111 908			

dph-no	dim 1	dim 2	dim 3	Style	Material	dph oil seal no.	Application	Type	OEM-NO	Eling	Corteco	Reinz
37120	18,00	30,00	7,00	AS	FPM	37113		BMW	32 13 1 123 773			
46912	18,00	30,00	7,00	B	NBR	19149		DB	001 997 8546			
46871	18,00	30,00	7,00	B	NBR	19149		DB	002 997 9446			
47757	18,00	30,00	7,00	B	NBR	19149		DB	304 997 1647			
35089	18,00	30,00	7,00	B	NBR	19149		MAN	06 56261 1207			
48450	18,00	30,00	7,00	A	NBR	17480	steering	VW	113 415 277			
82215	18,00	30,00	7/8	AS	NBR	4536	crankshaft	DB	005 997 6346			
61355	18,00	30,00	7/8	AS	NBR	4536	crankshaft	DB	009 997 5247		12011517	
34982	18,00	30,00	7/8	AS green	NBR	4536	gearbox	VW	020 301 227			
51951	18,00	30,00	7/8	AS	NBR	4536	gearbox	VW	020 301 227 C			
84570	18,00	30,00	7/8	AS	NBR	4536	crankshaft	ZF	0770 080 220			
95238	18,00	30,00	6,4/8,1	AS W SP	NBR	95237	gearbox	VW	020 301 227 D		01019317	
94336	18,00	32,00	6,00	AS RD	ACM	94335	oil pump	OPEL	646 268	490800	12015450	
33297	18,00	35,00	10,00	A	NBR	17489	injection pump	FORD	1 491 853		12010819	
119030	18,50	42,00	3,60	A OF	NBR	119029		FORD	FOCC3D527AA		19025707	
109066	19,00	28,90	7,00	A W Duo	NBR	109066						
97101	19,05	30,00	7,00	A	MVQ	97100	crankshaft	ZF	0770 080 442		01026490	
82221	19,05	30,00	7/8	AS RD blue	NBR	51224		DB	001 997 5447			
82990	19,05	30,00	7/8	AS RD blue	NBR	51224	crankshaft	DB	013 997 5847		01026490	
51490	19,05	31,75	6,35	A	NBR	20138		DB	000 997 8746			
37381	19,05	33,33	7,93	AS	NBR	95982	steering	DB	004 997 1247	278556		
3910	19,05	33,33	7,93	AS blue	NBR	95982	steering	DB	006 997 0247	278556	01020304	
47608	19,05	33,33	7,93	AS	NBR	95982	steering	DB	006 997 9247	278556		
36242	19,05	33,33	7,93	AS blue	NBR	95982	steering	DB	018 997 6047		01020304	
98193	19,05	33,33	8,00	AS RD SP	NBR	98193	steering	DB				
46915	19,60	33,00	9,00	AS	NBR	47942		DB	001 997 9446			
46941	19,60	33,00	9,00	AS	NBR	47942	water pump	DB	002 997 4846	054003		
46940	19,60	33,00	8/9	AS	NBR	68850	steering	DB	002 997 4746			
46952	19,60	33,00	8/9	AS	NBR	68850	steering	DB	002 997 7046			
46988	19,60	33,00	8/9	AS	NBR	68850	steering	DB	004 997 1546	006300		
47354	19,60	33,00	8/9	AS	NBR	68850	steering	DB	010 997 2546			
47033	20,00	28,00	6,00	A	NBR	19212	crankshaft	DB	005 997 7746		12001989	
114524	20,00	28,00	6,00	A	NBR	19212	crankshaft	MAN	06 56269 0578		12001989	
46956	20,00	30,00	5,00	B V	NBR	47943		DB	003 997 2846			
46979	20,00	30,00	5,00	B V	NBR	47943		DB	003 997 9646			

Dimensions

Dimensions

dph-no	dim 1	dim 2	dim 3	Style	Material	dph oil seal no.	Application	Type	OEM-NO	Eling	Corteco	Reinz
33267	20,00	30,00	7,00	AS blue	NBR	17505	transfer gearbox	BMW	32 22 1 108 259			
46917	20,00	30,00	7,00	B	NBR	17506		DB	001 997 9846			
47001	20,00	30,00	7,00	A	NBR	17504	transfer gearbox	DB	004 997 7146	102300		
47639	20,00	30,00	7,00	B	NBR	17506		DB	008 997 1047			
118826	20,00	30,00	5/6	AS	NBR	118826		ZF				
96969	20,00	30,00	7/8	AS W blue	NBR	96968	crankshaft	ZF	0770 080 256		12016820	
109255	20,00	30,00	5/5,5	AS	NBR	93745	steering	ZF	0770 198 130			
94291	20,00	32,00	6,00	SP	NBR	94291	steering	DB				
47028	20,00	32,00	7,00	BABSL	NBR	51422	steering	DB	005 997 5846	037524	12010824	
97892	20,00	32,00	7,00	BABSL	NBR	51422	steering	ZF	0634 302 121	037524		
46906	20,00	35,00	6,00	A	NBR	17511	crankshaft	DB	001 997 6846		12011484	
46907	20,00	35,00	6,00	A	NBR	17511	crankshaft	DB	001 997 6946			
46874	20,00	35,00	7,00	B	NBR	17514		DB	000 997 2746			
47440	20,00	35,00	7,00	B	NBR	17514		DB	000 997 2747			
47602	20,00	35,00	7,00	A	NBR	17512	crankshaft	DB	006 997 7447	106208	12010825	
47422	20,00	35,00	7,00	B	NBR	17514		DB	603 997 0446			
120109	20,00	35,00	7,00	BS RD	FPM	120111		Ferrari	15513			
33650	20,00	35,00	7,00	A	NBR	17512	gearbox	MAN	81 96502 0326	106208	12010825	
47423	20,00	35,00	8,00	B	NBR	42601		DB	608 997 0446			
47426	20,00	35,00	8,00	B	NBR	42601		DB	608 997 0946			
70571	20,00	35,00	7/10	AS RD	ACM	70816	gearbox	VW	014 311 113 A	091626		
47452	20,00	40,00	7,00	A	NBR	17524	crankshaft	DB	000 997 6947		12010826	
108783	20,00	40,00	8,00	A SP	FPM	84162		VOLVO	1 695 593			81-35302-00
46895	20,00	40,00	7/8	AS	NBR	47959	crankshaft	DB	000 997 9946		12011118	
47009	20,00	40,00	7/8	AS	NBR	47959	crankshaft	DB	004 997 9946		12011118	
114525	20,00	40,00	7/8	AS	NBR	47959	crankshaft	SCANIA	210 743		12011118	
111767	20,00	40,00	5,5/8	C RD SF	ACM	111766	crankshaft	FIAT	4000 4810		12014346	
33268	20,00	42,00	7,00	AS WD blue	NBR	48013	steering	BMW	32 41 1 117 621	277290		
47532	20,00	42,00	7,00	AS WD	NBR	48013	steering	DB	003 997 8147	277290	12012842	
46892	21,00	32,00	9,00	B SP	ACM	94769		DB	000 997 7746			
94770	21,00	32,00	9,00	B combi	ACM	94769	gearbox	OPEL	714 412		01019153	
47243	21,00	33,00	8/9,50	AS V	NBR	36731	steering	DB	006 997 8146	007544		
47398	21,00	33,00	8/9,50	AS blue	NBR	36731	steering	DB	011 997 6746	007544	01019308	
47408	21,00	33,00	8/9,50	AS blue	NBR	36731	steering	DB	011 997 8446	007544		
84204	21,00	33,00	8/9,50	AS blue	NBR	36731	steering	DB	016 997 1447			

dph-no	dim 1	dim 2	dim 3	Style	Material	dph oil seal no.	Application	Type	OEM-NO	Eling	Corteco	Reinz
97673	21,00	33,00	8/9,50	AS blue	NBR	36731	steering	DB	019 997 5147			
84264	21,00	35,00	10,00	AS W RD	ACM	84263		SAAB	87 108 81			
97912	21,40	40,00	7,30	B RD	ACM	97911	crankshaft	FORD	1 075 731		12017369	
80789	21,80	35,00	7,00	AS	NBR	80788	gearbox	VW	085 311 113		12015554	
37344	21,90	40,00	8,00	AS RD	ACM	37343	gearbox	VW	020 311 113	244040		81-23807-00
112376	21,90	40,00	8,00	AS RD	ACM	37343	gearbox	VW	020 311 113 D			81-23807-00
112894	22,00	30,00	5,70	A SP	FPM	112894	steering	VW				
46973	22,00	30,00	7,00	B	NBR	19269		DB	003 997 7446			
35208	22,00	30,00	7,00	B	NBR	19269		MAN	81 96501 0388			
98617	22,00	31,00	7,00	B	FPM	98614	gearbox	VW	087 409 133 C			
84262	22,00	32,00	7,00	AS W RD	ACM	84261	gearbox	SAAB	87 220 01			
70547	22,00	32,00	8,00	AS	NBR	32076	Injection	SCANIA	837 613	711500		
47509	22,00	32,00	7/8	AS	NBR	48039	crankshaft	DB	002 997 9547		12000459	
47018	22,00	32,00	7/8	AS	NBR	48039	gearbox	DB	005 997 3546	075175		
96505	22,00	32,00	7/8	AS	NBR	48039	gearbox	DB	012 997 8547			
82985	22,00	32,00	9/11	AS W	FPM	82985		VOLVO				
117967	22,00	32,75	7,50	A SP	NBR	117967						
94564	22,00	35,00	7,00	A W RD	ACM	94563		BMW	23 12 1 451 151			
46858	22,00	35,00	7,00	A	NBR	17557	crankshaft	DB	000 997 2546	120103	12010836	81-15377-00
97054	22,00	35,00	7,00	A/BS LD	FPM	118613	crankshaft	DEUTZ	117 2559		12011664	
114547	22,00	35,00	7,00	A LD	MVQ	94526	crankshaft	DEUTZ	416 0518			
119558	22,00	35,00	7,00	A/BS LD	FPM	118613	camshaft	Fiat	4000 4380		12011664	
117336	22,00	35,00	7,00	A LD	MVQ	94526	crankshaft	MAN	81 96501 0859	092614		
117334	22,00	35,00	7,00	A	NBR	17557	crankshaft	RVI	5000 294 202		12010836	
113769	22,00	35,00	7,00	A	NBR	17557	crankshaft	ZF	0634 302 143			
117335	22,00	35,00	7,00	A LD	MVQ	94526	crankshaft	MAN	K0 00117 2559			
114548	22,00	40,00	10,00	A	NBR	17567	crankshaft	MAN	06 56260 1408	037850	12010838	
4041	22,00	40,00	12/17	AS RD	ACM	4042	gearbox	VW	113 311 113 A	043605		
115417	22,00	45,00	7,00	AS W LD	FPM	112607	camshaft	RENAULT	77 03 087 191	508608	20015738	81-26392-10
48920	22,00	45,00	8,00	A LD	MVQ	48918	camshaft	VOLVO PC	3 344 397-9			81-15512-30
114550	22,00	47,00	10,00	B	NBR	68545	injection	DEUTZ	121 6319			81-19473-20
110482	22,20	40,00	12/17	AS RD	ACM	4042	gearbox	VW	113 311 113	043605		
98331	22,23	35,15	9,50	AS	FPM	81507	gearbox	VOLVO PC	1 518 399			
111528	23,00	35,00	6,50	A W RD	ACM	111527	crankshaft	VW	084 311 113 A		12015553	
111783	23,00	35,00	7,00	A/BS RD	FPM	111782	crankshaft	FIAT	4000 4200	440710	12011305	81-35719-00

Dimensions

Dimensions

dph-no	dim 1	dim 2	dim 3	Style	Material	dph oil seal no.	Application	Type	OEM-NO	Elring	Corteco	Reinz
94772	23,00	35,00	8,00	BS RD	FPM	94771	gearbox	OPEL	714 409		12017271	
96450	23,00	35,00	9,00	CS RD	FPM	111539	gearbox	OPEL	714 413		12018671	
94677	23,00	35,00	8/11	AS RD	ACM	94679	gearbox	PORSCHE	999 113 32740			
111383	23,00	36,00	6/7	A W RD	NBR	111391		CITROEN	2109.40	131860	07015547	
111817	23,00	36,00	6/7	A W RD	NBR	111391	gearbox	PEUGEOT	2109 40	131860	07015547	
35455	23,90	40,00	8,00	AS RD	ACM	96872	gearbox	VW	020 311 113 B		12016924	
32985	24,00	32,00	7,00	BS	NBR	32247	crankshaft	VW	281 415 749			
114551	24,00	35,00	8,00	BS RD	FPM	94771	gearbox	OPEL	714 809			
48453	24,00	37,00	7,00	A	NBR	17587	crankshaft	VW	311 415 297			
84568	24,00	37,00	7,00	B	NBR	19306	crankshaft	ZF	0770 080 244			
93747	24,00	37,00	7,00	A W	NBR	93746	crankshaft	ZF	0770 080 268			
33284	24,00	37,00	7,00	A W	NBR	93746		DB	001 997 5546			
94506	24,00	52,00	10,00		FEFZ	94506	crankshaft	DB	315 030 0080	171557		70-20311-00
47385	25,00	32,00	5,00	B OF	NBR	48055	gearbox	DB	011 997 2246	134600	01002919	
117332	25,00	32,00	5,00	B OF	NBR	48055	gearbox	MAN	81 96502 0117	134600	01002919	
117360	25,00	32,00	5,00	B OF	NBR	48055	gearbox	RVI	5000 815 354		01002919	
111591	25,00	35,00	7,00	B	NBR	4378	gearbox	DAF	0140 335	038083	12014616	
82208	25,00	35,00	7,00	B	NBR	4378	gearbox	DB	000 997 4346			
47492	25,00	35,00	7,00	AS	NBR	84590	injection pump	DB	002 997 2747	038075		
47551	25,00	35,00	7,00	AS	NBR	84590	injection pump	DB	004 997 6347			
47240	25,00	35,00	7,00	B	NBR	4378	gearbox	DB	006 997 4946	038083	12014616	
47347	25,00	35,00	7,00	AS	NBR	84590	injection pump	DB	009 997 9746	038075	12011122	
47688	25,00	35,00	7,00	AS	NBR	84590	injection pump	DB	010 997 6947			
93298	25,00	35,00	7,00	A DUO	FPM	93360		DB	010 997 8347			
47395	25,00	35,00	7,00	AS	NBR	84590	injection pump	DB	011 997 4746	038075	12011122	
117393	25,00	35,00	7,00	B	NBR	4378	gearbox	IVECO	4010 1080		12014616	
117303	25,00	35,00	7,00	B	NBR	4378	gearbox	MAN	06 56261 1609	038083	12014616	81-35123-00
35212	25,00	35,00	7,00	B	NBR	4378	gearbox	MAN	81 96501 0521	038083	12014616	
96084	25,00	35,00	7,00	B	NBR	4378	gearbox	MAN	81 96501 0864			
117337	25,00	35,00	7,00	AS	NBR	84590	injection pump	MAN	81 96503 0068			
117338	25,00	35,00	7,00	AS	NBR	84590	injection pump	RVI	5000 823 986			
70465	25,00	35,00	7,00	AS	NBR	84590	injection pump	SCANIA	192 600	038075	12011122	
70475	25,00	35,00	7,00	B	NBR	4378	gearbox	SCANIA	254 635	038083	12014487	
81460	25,00	35,00	7,00	BAB SL	NBR	4468	transfer gearbox	SCANIA	329 638		12014616	
119405	25,00	35,00	7,00	AS	NBR	84590	injection pump	VOLVO	192 600		12011122	

dph-no	dim 1	dim 2	dim 3	Style	Material	dph oil seal no.	Application	Type	OEM-NO	Elring	Corteco	Reinz
81848	25,00	35,00	7,00	AS	NBR	84590	injection pump	VOLVO	240 022	038075	12011122	
95884	25,00	35,00	7,00	B	NBR	4378	gearbox	VOLVO	6 876 142-8			
119406	25,00	35,00	7,00	B	NBR	4378	gearbox	VOLVO	6 876 348-1	038083	12014616	
82325	25,00	35,00	7,00	B	NBR	4378	gearbox	ZF	0634 300 302		12014616	
47302	25,00	35,00	8,00	A D	NBR	47303	steering	DB	008 997 6346	008427		
117330	25,00	35,00	8,00	AD	NBR	47303		MAN	81 96501 0530	008427		
70473	25,00	35,00	8,00	A D	NBR	47303	steering	SCANIA	211 337	008427		
80047	25,00	35,00	8,00	A D	NBR	47303	steering	VOLVO	338 425-2	008427		
46948	25,00	37,00	7,00	A	NBR	17609	crankshaft	DB	002 997 6346	137006		
21628	25,00	37,00	7,00	A	NBR	17609	crankshaft	DB	004 997 1646	137006	12010848	
95295	25,00	37,00	7,00	AS W	ACM	95321	crankshaft	STEYR	90 003 074 306			
96967	25,00	38,00	7,00	AW blue	NBR	96966	crankshaft	ZF	0770 080 286		12016917	
33286	25,00	40,00	7,00	A	NBR	17614	crankshaft	DB	001 997 8746		12010850	
47550	25,00	40,00	7,00	A	NBR	17614	crankshaft	DB	004 997 6247		12010850	
117395	25,00	40,00	7,00	AS	NBR	17615	crankshaft	IVECO	298 2310		12011123	
117394	25,00	40,00	7,00	AS	NBR	17615	steering	IVECO	767 775	038164	12011123	
46860	25,00	40,00	8,00	AS DUO	NBR	80977	gearbox	DB	002 997 7446	038164		
47525	25,00	40,00	8,00	B	NBR	19151		DB	003 997 6047			
47023	25,00	40,00	8,00	AS DUO	NBR	80977	gearbox	DB	005 997 4846	038164		
111526	25,00	40,00	8,00	AS RD	ACM	111525	gearbox	VW	016 311 113 B		12016989	
82333	25,00	40,00	10,00	A	NBR	17619	crankshaft	DEUTZ	116 0989			
82924	25,00	40,00	10,00	AS W RD	FPM	82793	fuel injection	DEUTZ	241 9323	462977		
109216	25,00	40,00	15,00	SP	FPM	109216	gearbox	ZF	0750 112 131		01029609	
94037	25,00	41,30	10,00	A SP	NBR	94037		VOLVO				
115416	25,00	42,00	7,00	AS W RD	FPM	112618	camshaft	RENAULT	77 03 087 192	508544	12015425	81-26389-30
118605	25,00	42,00	7,00	AS W RD	FPM	112618	camshaft	RVI	7703 087 192		12015425	
112618	25,00	42,00	7,00	AS W RD	FPM	112618	camshaft	VOLVO PC	3 287 556-9	508544		81-26389-30
114552	25,00	42,00	8,00	A/BS WD	FPM	114328	gearbox	DEUTZ	223 7010		01018323	
48921	25,00	42,00	8,00	A RD	MVQ	48919	camshaft	VOLVO PC	3 287 556-9			
46845	25,00	42,00	10,00	BS	NBR	19987		DB	000 997 2245	038229		
98094	25,00	42,00	10,00	AW	MVQ	98129	gearbox	DEUTZ	116 2568			
117256	25,00	42,00	10/7	A/BS WD	FPM	113739		DEUTZ	113 2992			
47432	25,00	42,90	9,50	B	NBR	47433	wheel hub	DB	000 997 1047			
96276	25,00	45,00	10,00	AW/BS RD SF	FPM	114330	crankshaft	DEUTZ	414 8959		01029747	
84622	25,00	47,00	10,00	A	NBR	68544	crankshaft	DAF	0119 198	038326	12010859	

Dimensions

Dimensions

dph-no	dim 1	dim 2	dim 3	Style	Material	dph oil seal no.	Application	Type	OEM-NO	Elring	Corteco	Reinz
70457	25,00	47,00	10,00	A	NBR	68544	crankshaft	SCANIA	170 761	038326	12010858	81-20553-10
96649	25,00	47,00	10,00	BABSL	NBR	96649	steering	ZF				
109763	25,00	49,70	10,5/15	AS W	FPM	81444	gearbox	DB	000 267 0297	457290		
95883	25,00	49,70	10,5/15	AS W	FPM	81444	gearbox	VOLVO PC	1 526 817			81-35308-00
47443	25,00	50,00	10,00	A	NBR	17648		DB	000 997 4347			
47482	25,00	52,00	7,00	B	NBR	17653	crankshaft	DB	001 997 8547	038385	01002458	
35090	25,00	52,00	7,00	B	NBR	17653	crankshaft	MAN	06 56261 1615	038385	01002458	
82337	25,00	62,00	10,00	AW/BS F	MVQ	82791	engine	DEUTZ	116 4594			
84558	25,00	62,00	10,00	AW/BS	MVQ	82791	engine	DEUTZ	414 8451			
117304	25,00	62,00	10,00	AW/BS F	FPM	82336	crankshaft	MAN	K0 00414 8451			
117067	25,45	44,43	5,1/6,1	AS WD	MVQ	116145	wheel hub	DAF	0692 009			
81508	25,94	41,30	10,00	AS	FPM	81508		VOLVO				
98403	26,00	31,00	3,00	B OF	NBR	51395	steering knuckle pin	DB	009 997 6746		01029621	
118552	26,00	34,00	4,5/7	AS SF	NBR	116002	crankshaft	DAF	0066 322		01020066	
119739	26,00	34,00	4,5/7	AS1 SF	NBR	116002		VOLVO	263 448			
84675	26,00	34,00	4,5/7	AS1 SF	NBR	116002	crankshaft	ZF	0770 080 252		01020066	
117206	26,00	34,00	4,5/7	AS1 SF	NBR	116002	crankshaft	ZF	0770 198 134		01020066	
35203	26,00	35,00	7,00	B	NBR	17670	crankshaft	MAN	81 96501 0296			
109254	26,00	35,00	7,00	A F	NBR	84567		ZF	7824 033 113			
114810	26,00	35,00	11,00	B OF SF blue	NBR	114809	crankshaft	DAF	1236 238		01027785	
47352	26,00	36,00	7,00	AS	NBR	19362	gearbox	DB	010 997 2346		01027966	
47370	26,00	36,00	7,00	AS	NBR	19362	gearbox	DB	010 997 6246			
93265	26,00	37,00	7,00	A	NBR	17672	crankshaft	DB	003 997 9946		12010865	
47371	26,00	37,00	7,00	AS	NBR	32164	gearbox	DB	010 997 7346		01201127	
93880	26,00	37,00	7,00	AS	NBR	32164	gearbox	MAN	81 96502 0356			
98406	26,00	37,00	7,91	A W SP	NBR	98405		ZF	0770 198 107			
46878	26,00	37,00	7/8	AS V W	NBR	47945	steering	DB	000 997 3946	006408		81-35069-00
46937	26,00	37,00	7/8	AS V W	NBR	47945	steering	DB	002 997 3846	006408	12010865	81-35069-00
46963	26,00	37,00	7/8	AS V W	NBR	47945	steering	DB	003 997 3946	006408		
47571	26,00	37,00	7/8	AS V W	NBR	47945	steering	DB	005 997 3747	006408	12014826	81-35069-00
93878	26,00	37,00	7/8	AS V W	NBR	47945	steering	DB	008 997 9447	006408	12014826	
95271	26,00	37,00	7/8	AS V W	NBR	47945	steering	DB	013 997 4547			
116196	26,00	37,00	7/8	AS V W	NBR	47945	steering	SCANIA	195 532			
114553	26,00	37,00	7/8	AS V W	NBR	47945	steering	SCANIA	318 996	006408	12014826	81-35069-00
36627	26,00	37,00	7/8	AS V W	NBR	47945	steering	VOLVO	341 050	006408	12014826	81-35069-00

dph-no	dim 1	dim 2	dim 3	Style	Material	dph oil seal no.	Application	Type	OEM-NO	Elring	Corteco	Reinz
93879	26,00	37,00	7/8	AS V W	NBR	47945	crankshaft	ZF	0770 198 103		12014826	
98618	26,00	38,00	6,00	BS	NBR	98613	gearbox	VW	089 409 085 C			
37637	26,00	42,00	8,00	A/BS RD	FPM	81064	crankshaft	OPEL	646 262		12013858	
37636	26,00	42,00	8,00	AS RD	MVQ	37636	crankshaft	OPEL	646 262	049557		81-24911-00
81063	26,00	42,00	8,00	A/BS RD	FPM	81064	crankshaft	OPEL	646 267	755141	12013858	
68535	26,00	42,00	8,00	A/BS RD	FPM	81064	crankshaft	OPEL	646 270	755141	12013858	81-27295-00
81577	26,00	42,00	8,00	AS RD	MVQ	37636	crankshaft	OPEL	646 274			
81064	26,00	42,00	8,00	A/BS RD	FPM	81064	crankshaft	OPEL	646 274			81-27295-00
109271	26,00	42,00	8,00	A/BS RD	FPM	81064	crankshaft	OPEL	646 816		12013858	
46927	26,00	42,00	10,00	AS	NBR	19376	steering	DB	002 997 1946	006297		
46938	26,00	42,00	10,00	AS	NBR	19376	steering	DB	002 997 4346	006297	01019456	
48936	26,00	43,00	7,00	A W RD	FPM	48935	crankshaft	VOLVO PC	1 218 239		20025648	
4502	26,00	45,00	10,00	B blue	NBR	4442	injection	DB	003 997 4046	038490	12011330	81-20308-00
94046	26,30	36,20	7,30	AS	NBR	94045		VOLVO	943 741-9	246905	01027966	
94560	26,50	40,00	7,00	A RD	ACM	94558		BMW	23 12 1 232 249			
94559	26,50	40,00	7,00	A RD	ACM	94558		BMW	23 12 1 338 726			
114554	27,00	37,00	7,00	A	NBR	17672	crankshaft	MAN	06 56269 0458		12010870	
97929	27,00	42,00	6,00	AS RD W	ACM	97928	crankshaft	FORD	6 184 211		12015750	
96384	27,00	42,00	8,00	A/BS RD	FPM	96387	camshaft	VW	036 103 085 A	076110	12018554	81-34226-00
114058	27,00	47,00	7,00	AS W RD	ACM/PTFE	114095	camshaft	FORD	1 145 953	026740	20029115	81-35552-00
115459	27,00	47,00	7,00	AS W RD	ACM/PTFE	114095	camshaft	PEUGEOT	0807 28			
117125	27,94	56,00	8,00	AS W RD	FPM	117124	differential	PEUGEOT	3121 42		20026878	
117126	27,94	56,00	8,00	AS W RD	FPM	117124	differential	RENAULT	77 03 087 210		20026878	
115412	27,95	56,00	10,00	ASW RD	ACM	115411	differential	RENAULT	77 03 087 146	050560	07011906	
115414	27,95	70,00	10,00	ASW RD	ACM	115413	differential	RENAULT	77 03 087 148		12015423	
96990	28,00	37,00	5,00	A W	NBR	96989	crankshaft	ZF	0770 080 457		01016891	
33265	28,00	38,00	7,00	A	NBR	17693	steering	BMW	32 11 1 104 719			
81138	28,00	38,00	7,00	AS RD	FPM	81139		FORD	6 135 090	562653	12013949	81-26268-00
70449	28,00	38,00	7,00	A	NBR	17693	steering	SCANIA	136 106		12000129	
93749	28,00	38,00	7,00	A SP	NBR	93748		ZF	7852 033 108		01015867	
114555	28,00	38,00	7,00	A SP	NBR	93748		ZF	7852 033 110		01015867	
95717	28,00	38,00	7,00	SP	NBR	95717	steering	ZF				
82246	28,00	38,00	9/11	AS W	FPM	82246		VOLVO				
37452	28,00	40,00	7,00	A RD W	FPM	37451	camshaft	BMW	11 14 1 271 415	562939	20020463	81-19159-10
115878	28,00	40,00	7,00	A RD W	FPM	37451	camshaft	BMW	11 14 1 707 107	562939		

Dimensions

Dimensions

dph-no	dim 1	dim 2	dim 3	Style	Material	dph oil seal no.	Application	Type	OEM-NO	Eling	Corteco	Reinz
37118	28,00	40,00	7,00	AS	NBR	93614	crankshaft	BMW	32 13 1 111 871			
46953	28,00	40,00	7,00	AS	NBR	93614	crankshaft	DB	003 997 1346		12010874	
46999	28,00	40,00	7,00	B	NBR	33354		DB	004 997 6446			
37130	28,00	40,00	7,00	B	NBR	33354		DB	008 997 0346			
61443	28,00	40,00	7,00	AS	NBR	93614	crankshaft	DB	009 997 7246			
116028	28,00	40,00	7,00	A	NBR	17697	crankshaft	DEUTZ	116 0652	164500		
119279	28,00	40,00	7,00	A	NBR	17697		KHD	115 1122			
33338	28,00	40,00	7,00	AS blue	NBR	93614	gearbox	OPEL	902 678	164500	12010874	
33353	28,00	40,00	7,00	B	NBR	33354		PORSCHE	900 112 01940			
114556	28,00	40,00	7,00	AS	NBR	93614	crankshaft	RENAULT	094 83 504 09	164500	12010874	
81380	28,00	40,00	7,00	AS W WD	MVQ	84575	crankshaft	STEYR	90 003 070 014		11029673	
98616	28,00	40,00	7,00	B	FPM	98615	gearbox	VW	087 409 485 B			
48451	28,00	40,00	7,00	A	NBR	17697	crankshaft	VW	113 415 297	164500		
119851	28,00	40,00	8,00	B RD SP	NBR	113726	transmission, input	VOLVO PC	1 377 748			
97907	28,00	40,00	7/8,5	AS RD	ACM	97906	gearbox	FORD	6 152 663		01031967	
48358	28,00	40,00	8/6,00	AS SP	NBR	36704	steering	DB	011 997 7246	237744	12012574	
112559	28,00	40,00	8/6,00	AS SP	NBR	36704	steering	DB	014 997 6947		01020082	
80857	28,00	40,00	8/6,00	AS SP	NBR	36704		DB	016 997 2147			
118371	28,00	40,00	8/6,00	AS SP	NBR	36704		DB	616 997 0146		01034698	
47518	28,00	40,00	8/8,50	AS	NBR	48011	crankshaft	DB	003 997 2647	237744		
109072	28,00	42,00	5,00	AS RD	FPM	109071	camshaft	RENAULT	77 01 471 376	073890	12018754	81-34408-00
82439	28,00	42,00	7,00	AS W RD	MVQ	48466	crankshaft	LADA	2108 100 5040			
94552	28,00	47,00	7,00	A W RD	ACM	94551		BMW	11 14 1 255 011			
80376	28,00	47,00	10,00	B	NBR	19153	rear axle	DB	000 997 7547	038660	01002474	81-20307-00
98093	28,00	47,00	10,00	A	MVQ	98091		DEUTZ	116 2569			
117315	28,00	47,00	10/7	A/BS WD	FPM	113738		DEUTZ	116 0655			
114015	28,00	52,00	7,00	B	NBR	51524	crankshaft	DB	011 997 5447		01002476	
47444	28,00	52,00	10,00	A	NBR	17714	crankshaft	DB	000 997 4447		12010876	
37061	29,00	50,00	10/7	AW/BS LD	ACM	82254	injection pump	VOLVO	424 580-9	755087	12014476	
113050	29,85	47,00	9,90	AS W WD	FPM	113050	differential	PEUGEOT	3121 10			
114557	29,85	47,00	11,30	combi	ACM	95498		CITROEN	3121.26	128240	20015497	
109151	29,85	47,00	11,30	combi	ACM	95498		CITROEN	9608 0792		20015497	
98169	29,85	47,00	11,30	combi	ACM	95498	differential	PEUGEOT	3121 26	128240	20015497	
115082	29,85	47,00	9,9/17	AS2 W RD blue	NBR	114902	differential	PEUGEOT	3121 10		07011583	
47599	29,90	47,00	8,00	AW RD	FPM	47983	steering	DB	006 997 6147			

dph-no	dim 1	dim 2	dim 3	Style	Material	dph oil seal no.	Application	Type	OEM-NO	Eling	Corteco	Reinz
47611	29,90	47,00	8,00	AW RD	FPM	47983	steering	DB	007 997 1547			
47612	29,90	47,00	8,00	AW RD	FPM	47983	steering	DB	007 997 1647			
47613	29,90	47,00	8,00	AW RD	FPM	47983	steering	DB	007 997 1747			
69270	29,90	47,00	8,00	AW RD	FPM	47983	steering	DB	014 997 6347	582689	01034077	
120457	30,00	37,00	4,00	AO	NBR	21609	gearbox	RVI	5010 439 193		12015561	
114558	30,00	40,00	7,00	A	NBR	113776	crankshaft	DAF	0119 199	201006	12010879	
46998	30,00	40,00	7,00	AS	NBR	17725	crankshaft	DB	004 997 6246	038806	12011131	
47598	30,00	40,00	7,00	AS RD W	FPM	47982	camshaft	DB	006 997 5347	598993	12014403	
47259	30,00	40,00	7,00	B	NBR	17726		DB	007 997 3446			
47306	30,00	40,00	7,00	B	NBR	6451	crankshaft	DB	008 997 7346	038814		
47666	30,00	40,00	7,00	B	NBR	6451	crankshaft	DB	009 997 6447	038814		
47684	30,00	40,00	7,00	AS RD W	FPM	47982	camshaft	DB	010 997 6147	589993	20020461	
47685	30,00	40,00	7,00	AS RD W	FPM	47982	camshaft	DB	010 997 6247			
82551	30,00	40,00	7,00	AS RD W	FPM	47982	camshaft	DB	018 997 7947	598993	12011131	81-15512-50
114559	30,00	40,00	7,00	A	NBR	113776	crankshaft	MAN	06 56260 1911	201006	12010879	
4716	30,00	40,00	7,00	B blue	NBR	6451	crankshaft	MAN	06 56261 1911	038814		
110599	30,00	40,00	7,00	AS RD W	FPM	47982	camshaft	OPEL	646 260	508489		81-15512-50
114341	30,00	40,00	7,00	AS RD W	PTFE/AEM	114341	crankshaft	OPEL	646 260		20019549	
82971	30,00	40,00	7,00	AS RD W	FPM	47982	camshaft	RENAULT	77 01 349 625			
94507	30,00	40,00	7,00	AS RD W	FPM	47982	camshaft	RENAULT	77 03 087 189	508489	12014403	81-15512-50
119288	30,00	40,00	7,00	AS W LD	FPM	112608	crankshaft	Rover	LUC100290		19027629	
46946	30,00	40,00	7,00	AS	NBR	17725		DB	002 997 6146	038806		
116162	30,00	40,00	7/10	BABSL	NBR	6440		DB	003 997 0040	201200		
115695	30,00	40,00	7/10	BABSL	NBR	6440		DB	005 997 3547		01026333	
94290	30,00	42,00	6,00	A SP	NBR	94290	steering	DB				
51728	30,00	42,00	7,00	AS RD	FPM	51727	manual transmission	BMW	23 11 1 228 314		12011839	
96051	30,00	42,00	7,00	A/B	ACM	96051	gearbox	BMW	23 11 1 228 314			
82102	30,00	42,00	7,00	AS RD	ACM	82102	gearbox	BMW	23 11 1 228 314	277142		
33254	30,00	42,00	7,00	A	NBR	17728	crankshaft	BMW	23 12 1 201 279	203408		
116032	30,00	42,00	7,00	AS RD	FPM	51727	manual transmission	BMW	23 12 1 202 715	277142		
84217	30,00	42,00	7,00	AS RD	FPM	51727	manual transmission	BMW	23 12 1 205 186	277142	12010674	
116038	30,00	42,00	7,00	A	NBR	17728	crankshaft	BMW	24 51 6 606 714	203408		
116120	30,00	42,00	7,00	A	NBR	17728	crankshaft	BMW	33 12 3 004 336	203408		
33269	30,00	42,00	7,00	A	NBR	17728	crankshaft	BMW	33 12 3 004 337	203408		
46916	30,00	42,00	7,00	A	NBR	17728	crankshaft	DB	001 997 9746	203408		

Dimensions

Dimensions

dph-no	dim 1	dim 2	dim 3	Style	Material	dph oil seal no.	Application	Type	OEM-NO	Eling	Corteco	Reinz
46977	30,00	42,00	7,00	B	NBR	17729		DB	003 997 8546	038865		
84565	30,00	42,00	7,00	A	NBR	17728	crankshaft	DB	005 997 5946		12010880	
47603	30,00	42,00	7,00	A	NBR	17728	crankshaft	DB	006 997 7647	203408	12010880	
47633	30,00	42,00	7,00	A	NBR	17728	crankshaft	DB	007 997 8847	203408		
109073	30,00	42,00	7,00	AS RD	FPM	51727	camshaft	FIAT	4000 4240	277142	12010674	
114560	30,00	42,00	7,00	A	NBR	17728	crankshaft	MAN	06 56260 1912	203408	12010880	
111540	30,00	42,00	7,00	AS RD	ACM	82102	gearbox	OPEL	730 669			
112375	30,00	42,00	7,00	AS RD	FPM	51727	manual transmission	PORSCHE	999 113 46340			81-33402-00
115410	30,00	42,00	7,00	AS RD	FPM	51727	manual transmission	RENAULT	77 00 101 348	365940	20019850	
110810	30,00	42,00	7,00	AS RD	FPM	51727	manual transmission	RENAULT	77 00 749 395	505838	12011839	81-17539-50
96746	30,00	42,00	7,00	A Duo	NBR	96746						
46914	30,00	42,00	8,00	AS	NBR	19424		DB	001 997 9346			
46859	30,00	42,00	8,00	AS	NBR	19424		DB	002 997 7146			
37131	30,00	42,00	8,00	AS	NBR	19424	crankshaft	DB	002 997 7246		01019320	
46970	30,00	42,00	8,00	AS	NBR	19424		DB	003 997 5346			
37535	30,00	42,00	9,00	A W	ACM	37535		DB				
95803	30,00	42,00	8/7	AS LD	NBR	82139	crankshaft	DEUTZ	116 3273		01029927	81-17539-10
110737	30,00	42,00	6/6,8	BABSL WD	NBR	84542	injection pump	IVECO	819 4388		11014231	
116195	30,00	42,00	6/6,8	BABSL WD	NBR	84542	injection pump	SCANIA	170 075			
84543	30,00	42,00	6/6,8	BABSL WD	NBR	84542	injection pump	SCANIA	280 759		11014231	
111787	30,00	43,00	8,00	A/BS RD	FPM	111786	camshaft	ALFA	6080 5219	440730	12001538	
6653	30,00	43,00	8/5,50	AS SP blue	NBR	32849		DB	009 997 0147		01019307	
117311	30,00	44,00	7,00	AS RD	NBR	104536	crankshaft	MAZDA	B630-10-602	022160		81-53228-00
115690	30,00	45,00	8,00	AS WD	FPM	115689	crankshaft	OPEL	636 842			
70450	30,00	47,00	7,00	AS	NBR	17741	transfer gearbox	SCANIA	139 023		12000480	
4293	30,00	47,00	7,00	A SP	NBR	6763	camshaft	VOLVO	3 514 943			81-33636-00
113644	30,00	47,00	7,00	A WD	FPM	113644	camshaft	VOLVO	3 514 943	135150	01500581	
46993	30,00	47,00	8,00	B	NBR	36748	gearbox	DB	004 997 3246	038873		
47557	30,00	47,00	8,00	B	NBR	36748	gearbox	DB	004 997 7547	038873		
47577	30,00	47,00	8,00	B	NBR	36748	gearbox	DB	005 997 6047	038873		
47587	30,00	47,00	8,00	B	NBR	36748	gearbox	DB	005 997 8647	038873	01002484	
68575	30,00	47,00	8,00	A RD	NBR	61495		DB	006 997 7247			
47649	30,00	47,00	8,00	AS	NBR	19169		DB	008 997 3547	206806		
114561	30,00	47,00	8,00	BS	ACM	81348	crankshaft	IVECO	4010 0790		12012768	
118920	30,00	47,00	8,00	BS	ACM	81348	crankshaft	IVECO	4010 0791		12012768	

dph-no	dim 1	dim 2	dim 3	Style	Material	dph oil seal no.	Application	Type	OEM-NO	Eling	Corteco	Reinz
47458	30,00	47,00	10,00	A	NBR	17745	crankshaft	DB	000 997 9747	208302		
116194	30,00	47,00	10,00	A	NBR	17745	crankshaft	SCANIA	170 072			
82871	30,00	47,00	10/7	AS W WD F	ACM	82870	crankshaft	SCANIA	1 109 869		12014828	
95589	30,00	48,00	10,00	A RD	ACM	95588	gearbox	BMW	23 12 1 204 211	038938		81-35284-00
116036	30,00	48,00	10,00	A RD	ACM	95588	gearbox	BMW	23 12 1 606 122	038938		
116037	30,00	48,00	10,00	A RD	ACM	95588	gearbox	BMW	23 12 1 606 123	038938		
114051	30,00	50,00	7,50	AS W RD	ACM/PTFE	114096	crankshaft	FORD	1 198 045	026770	20029769	
46935	30,00	50,00	10,00	A	NBR	17754	crankshaft	DB	002 997 3046		12010885	
46975	30,00	50,00	10,00	B	NBR	17755		DB	003 997 7746			
114562	30,00	50,00	10,00	A	NBR	17754	crankshaft	DEUTZ	116 0750		12010885	
94831	30,00	50,00	10,00	A/BS RD	ACM	80247		PORSCHE	999 113 04940			
111395	30,00	50,00	10,00	A W RD	FPM	111402	crankshaft	PORSCHE	999 113 29041	347922		
97152	30,00	52,00	7,00	A/B RD	ACM	111768	crankshaft	FIAT	4000 0470	212458	12011539	
111769	30,00	52,00	7,00	A/B RD	ACM	111768	crankshaft	FIAT	4000 4460	212458	12012411	
111791	30,00	52,00	7,00	A/BS RD	FPM	111790	crankshaft	FIAT	4000 4770		12015855	
118339	30,00	52,00	8,00	A	NBR	17766	injection	SCANIA	170 074			
47481	30,00	52,00	9,00	C	NBR	95183	crankshaft	DB	001 997 8447	462829	01033894	
114563	30,00	52,00	10,00	A	NBR	17768	wheel hub	SCANIA	139 038		12010887	
94991	30,00	54,00	15/19	SP	FPM	94991						
94989	30,00	54,00	15/19,30	AS LD SP	FPM	113724	camshaft	VOLVO PC	3 507 309	393880	15029743	81-35989-00
110734	30,00	55,00	10,00	A	NBR	17780	crankshaft	IVECO	4587 996		12010889	
110724	30,00	55,00	10,00	A	NBR	17780	crankshaft	IVECO	724 579		12010889	
110725	30,00	55,00	10,00	A	NBR	17780	crankshaft	IVECO	734 128		12010889	
70452	30,00	55,00	10,00	A	NBR	17780	crankshaft	SCANIA	144 116		12010889	
115678	30,00	62,00	12,00	AS	NBR	32023		DEUTZ	116 0752			81-22529-10
111789	31,00	41,00	7,00	A/BS RD	FPM	111788	crankshaft	FIAT	762 8850	069590	12018321	81-35882-00
37866	31,00	50,00	8,00	AS RD	FPM	37865	crankshaft	OPEL	646 263	330736	12013458	
68536	31,00	50,00	8,00	AS RD	FPM	37865	crankshaft	OPEL	646 265		12013458	81-25516-10
96024	31,00	50,00	8,00	AS RD	FPM	37865	crankshaft	OPEL	646 289	694739	12013458	
113602	32,00	42,00	8,00	AS RD W	FPM	113932	camshaft	VW	036 103 085 C		20019960	
109070	32,00	42,00	8,00	AS RD W	FPM	113932	camshaft	VW	036 103 085 H	158060	20019960	
47409	32,00	44,00	8/9,5	AS V	NBR	48045	steering	DB	011 997 8546	007552		
47244	32,00	44,00	8/9,50	AS	NBR	36730	steering	DB	006 997 8246	007552		
82174	32,00	44,00	8/9,50	AS blue	NBR	36730		DB	019 997 5047		01025508	
115419	32,00	45,00	6,00	AS RD SP	FPM	115434	crankshaft	BMW	11 11 1 485 171			

Dimensions

Dimensions

dph-no	dim 1	dim 2	dim 3	Style	Material	dph oil seal no.	Application	Type	OEM-NO	Elring	Corteco	Reinz
114564	32,00	45,00	7,00	A	NBR	17829	wheel hub	DAF	0662 004		12000157	
47434	32,00	45,00	7,00	A	NBR	17829	wheel hub	DB	000 997 1147	227609	12000157	
47533	32,00	45,00	7,00	A	NBR	17829	wheel hub	DB	003 997 8647	227609		
46978	32,00	45,00	7,00	A	NBR	17829	wheel hub	DB	003 997 8946	227609		
82214	32,00	45,00	7,00	A	FPM	20553		DB	005 997 6146			
82213	32,00	47,00	7,00	B	NBR	17833		DB	004 997 4346			
6512	32,00	47,00	10,00	W WD	FPM/ACM	97600	crankshaft	VW	026 103 085	325155	12012709	
112747	32,00	47,00	10,00	AS W WD	FPM/ACM	97600	crankshaft	VW	026 103 085 D		12012709	
111513	32,00	47,00	10,00	AS W WD	FPM/ACM	97600	crankshaft	VW	026 103 085 F		12012709	
98140	32,00	47,00	10,00	AS RD SP	PTFE/ACM	112807	crankshaft	VW	038 103 085 C	129780	20026413	
34694	32,00	47,00	10,00	AS W WD	FPM/ACM	97600	crankshaft	VW	056 103 085	325155	12012709	
35510	32,00	47,00	10,00	AS W WD	FPM/ACM	97600	crankshaft	VW	056 103 085 B		12012709	
35013	32,00	47,00	10,00	AS W WD	FPM	37434	crankshaft	VW	068 103 085	325155	12012709	81-19299-10
34885	32,00	47,00	10,00	AS W WD	FPM/ACM	97600	crankshaft	VW	068 103 085 A			
35801	32,00	47,00	10,00	AS W WD	ACM	61485	crankshaft	VW	068 103 085 ACM			
111205	32,00	47,00	10,00	AS W WD	FPM/ACM	97600	crankshaft	VW	068 103 085 E			
82224	32,00	50,00	12,00	C	NBR	17846		DB	005 997 8547			
114049	33,00	47,00	5,00	AS W RD	FPM	114098	crankshaft	FORD	1 112 945	023590	15510081	
46991	33,00	50,00	8,00	B	NBR	97159		DB	004 997 2846			
47029	33,00	50,00	8,00	B	NBR	97159		DB	005 997 6946			81-33857-00
47291	33,00	50,00	8,00	B	NBR	97159		DB	008 997 1346			
47407	33,00	50,00	8,00	B	NBR	97159		DB	011 997 8346			
69128	33,00	50,00	10/12	BS LD	NBR	69128		DB				
84468	33,00	56,00	11,8/9	A/B WD	ACM	84729	differential	DB	014 997 5747	388180	01019286	
117310	34,00	48,00	7,00	AS RD	MVQ	104534	crankshaft	MAZDA	F801-10-602	022170		81-53243-00
116105	34,00	52,00	7,00	A W	ACM	104443	gearbox	VW	096 323 862		01025670	
47099	34,00	52,00	8,00	A	ACM	48043		DB	006 997 3246			
47262	34,00	52,00	8,00	A	ACM	48043		DB	007 997 4046			
47297	34,00	52,00	8,00	A	NBR	17888	automatic gearbox	DB	008 997 2546	048364		
34036	34,00	52,00	8,00	A	NBR	17888	automatic gearbox	DB	008 997 9146	048364	01010901	
46930	34,00	52,00	8,00	A	NBR	17888	front axle	DB	002 997 2046	048364		
117968	34,00	55,00	15,50	B SP	NBR	117968						
80990	34,00	72,00	10/12	AS RD	ACM	80989	rear axle	OPEL	406 753			
94784	34,00	72,00	10/12	AS RD	ACM	80989	rear axle	OPEL	406 766			
114565	34,90	62,00	8,00	A/BS LD	ACM	114332	injection pump	VOLVO	1 546 221	760240	12017218	81-33677-00

dph-no	dim 1	dim 2	dim 3	Style	Material	dph oil seal no.	Application	Type	OEM-NO	Elring	Corteco	Reinz
37648	34,93	49,96	8,00	AS W WD	MVQ	37652	crankshaft	FORD	6 123 792	586757		81-22700-10
114566	35,00	22,00	8,00	SP	PTFE	114333		CATERPIL	8C5210			
117357	35,00	42,00	4,00	BO	NBR	95957	front axle	MAN	06 56279 0290			
117359	35,00	42,00	4,00	BO	NBR	95957	front axle	MAN	06 56279 0291			
117358	35,00	42,00	4,00	BO	NBR	95957	front axle	MAN	06 56279 0292			
96199	35,00	42,00	5,50	BS OF	NBR	96201		IVECO	4200 1982			
115774	35,00	47,00	6,00	AS RD	FPM	113719	crankshaft	RENAULT	77 00 273 776		20019851	81-15855-40
115506	35,00	47,00	6,00	AS RD	FPM	113719	crankshaft front	VOLVO PC	6 842 273	336999	12015674	
109147	35,00	47,00	7,00	AW RD	FPM/ACM	112614	crankshaft	CITROEN	7700 619 237		12013859	81-15855-40
114568	35,00	47,00	7,00	AS RD	MVQ	37506	crankshaft	CITROEN	7700 619 237 alt			
47438	35,00	47,00	7,00	BS	NBR	22670		DB	000 997 2447			
46933	35,00	47,00	7,00	AS RD W	NBR	47976		DB	002 997 2446			
47576	35,00	47,00	7,00	A	NBR	17906	crankshaft	DB	005 997 5847	251402	12010904	
117396	35,00	47,00	7,00	AS	NBR	17907	crankshaft	IVECO	126 8104		12011143	
35,00	47,00	7,00	AS RD	MVQ	37506	crankshaft	RENAULT	77 00 854 842			81-25582-00	
110863	35,00	47,00	7,00	A W RD	FPM/ACM	112614	crankshaft	RENAULT	77 00 854 842	504483	12013859	81-35506-00
33550	35,00	47,00	7,00	AW RD	FPM/ACM	112614	crankshaft	VOLVO PC	1 306 333		12013859	
114569	35,00	47,00	7,00	AS RD	MVQ	37506	crankshaft	VOLVO PC	1 306 333	336998		81-25582-00
114567	35,00	47,00	8/7	AS W WD	ACM	113716	wheel hub	SAAB	87 31 804		01018330	
37462	35,00	48,00	7,00	AS RD	MVQ	36781	crankshaft	OPEL	636 838		20011244	
80070	35,00	48,00	7,00	AS RD	MVQ	36781	crankshaft	OPEL	636 841	702269	20011244	81-24909-10
109272	35,00	48,00	10,00	A/BS W RD	FPM	81442	crankshaft	FORD	1 005 301	294357		81-24292-10
51384	35,00	48,00	10,00	A/BS W RD	FPM	81442	crankshaft	VOLVO PC	1 257 113	294357	12010739	81-24292-10
113715	35,00	48,00	10,00	AS W RD	FPM	113715	crankshaft front	VOLVO PC	1 257 113			
114570	35,00	48,00	10,00	AS W RD	ACM	51382	crankshaft	VOLVO PC	1 257 113			
111623	35,00	48,00	10,00	AS W SP	ACM/PTFE	111624	crankshaft	VW	022 103 085			81-36791-00
51383	35,00	48,00	10,00	A/BS W RD	FPM	81442	crankshaft	VW	034 115 147 A		12010739	
112729	35,00	48,00	10,00	AS W SP	AEM/PTFE	111624	crankshaft	VW	038 103 085 E	155560	20026412	81-34366-00
83914	35,00	48,00	10,00	AS W RD	ACM	51382	crankshaft	VW	054 115 147			
51382	35,00	48,00	10,00	AS W RD	ACM	51382	crankshaft	VW	054 115 147 B			
109220	35,00	48,00	10,00	A/BS W RD	FPM	81442	crankshaft	VW	054 115 147 B	475961	12010739	81-24292-10
68844	35,00	48,00	10,00	AS W RD	ACM	51382	crankshaft	VW	069 115 147 C			
81442	35,00	48,00	10,00	A/BS W RD	FPM	81442	crankshaft	VW	069 115 147 C	294357	12010739	81-24292-10
59258	35,00	50,00	7,00	A W RD	MVQ	59255	crankshaft	CITROEN	7910 006 487	293946		
80383	35,00	50,00	7,00	A/B RD	FPM	50167	crankshaft	DB	010 997 4547		01020122	

Dimensions

Dimensions

dph-no	dim 1	dim 2	dim 3	Style	Material	dph oil seal no.	Application	Type	OEM-NO	Elring	Corteco	Reinz
96238	35,00	50,00	7,00	A W RD	MVQ	59255	crankshaft	FORD	1 614 995			
96246	35,00	50,00	7,00	A/B RD	FPM	50167	crankshaft	FORD	1 663 814		15510079	
84269	35,00	50,00	7,00	A/B RD	FPM	50167	crankshaft	FORD	6 165 499	757292		81-25451-10
80635	35,00	50,00	7,00	A W RD	MVQ	59255	crankshaft	FORD	6 165 500			
115457	35,00	50,00	7,00	A/B RD	FPM	50167	crankshaft	PEUGEOT	0807 14	757292	20018100	81-25451-10
114050	35,00	50,00	8,00	A RD SP	ACM/PTFE	114092	crankshaft	FORD	1 119 162	023630	20034565	81-35551-00
115733	35,00	50,00	8,00	A RD	ACM	3900	camshaft	Mitsubishi	MD 008762	293946	19015083	
36382	35,00	50,00	8,00	A RD	ACM	3900	crankshaft	OPEL	646 266			81-21798-40
97203	35,00	50,00	8,00	AS W RD	FPM/ACM	97204	crankshaft	OPEL	646 290	694657	12013459	81-21798-00
115456	35,00	50,00	8,00	AS WD W	FPM	112621	crankshaft	PEUGEOT	0236 14	302589	12016927	81-21798-50
3901	35,00	50,00	8,00	A RD	ACM	3900	crankshaft	PEUGEOT	0514 15	293946	12011547	81-21798-30
115409	35,00	50,00	8,00	AS W RD	FPM/ACM	97204	crankshaft	RENAULT	77 00 859 691	507806	12013459	
82228	35,00	50,00	8/5,50	BABSL	NBR	4485	crankshaft	DB	016 997 2047		01019970	
48411	35,00	52,00	7,00	A RD	FPM	48410	automatic gearbox	BMW	23 12 1 220 619		01019289	
47457	35,00	52,00	10,00	B	NBR	19998		DB	000 997 8947			
33282	35,00	52,00	10,00	B	NBR	19998		DB	001 997 2646			
47575	35,00	52,00	10,00	A	NBR	17934	crankshaft	DB	005 997 5147	258407		
47664	35,00	52,00	10,00	A	NBR	17934	crankshaft	DB	009 997 5147	258407	12010908	
118917	35,00	52,00	10,00	AS W WD	ACM	112653	crankshaft	SCANIA	1 122 619		01026707	
112654	35,00	52,00	10,00	AS W WD	ACM	112653	crankshaft	SCANIA	1 122 620		01026707	
70484	35,00	52,00	10,00	A	NBR	17934	gearbox	SCANIA	32 201	258407	12010899	
94783	35,00	54,00	13,00	AS RD SP	ACM	94782	crankshaft	OPEL	374 227		19033964	
97901	35,00	54,00	10/15	AW/BS WD SF	ACM	97900	front axle	OPEL	374 197		12017376	
114571	35,00	55,00	12,00	AS W RD	ACM	36204	crankshaft	BMW	11 14 1 255 014		12013416	
84172	35,00	55,00	12,00	AS W RD	ACM	36204	crankshaft	BMW	11 14 1 278 108		12013416	
36214	35,00	55,00	12,00	AS W RD	ACM	36204	crankshaft	BMW	11 14 1 709 632	587044	12013416	81-19886-10
116813	35,00	55,00	8/14	HTB5Y	NBR	118408	differential	OPEL	374 594		19033952	
116562	35,00	55,00	12/16	SP	NBR	116561		DB	000 997 1346			
47445	35,00	56,00	12,00	B	NBR	19521		DB	000 997 4547			
47453	35,00	56,00	12,00	B	NBR	19521		DB	000 997 7847			
82323	35,00	58,00	10,00	A	NBR	17960	crankshaft	SCANIA	132 672		12010911	
97172	35,00	60,00	15,00	AS	NBR	97174	crankshaft	VW	113 301 189 F	277517		
104542	35,00	62,00	7,00	AS W WD	ACM	84536	camshaft	SCANIA	1 109 870	580202	12014830	81-26592-10
116197	35,00	62,00	7,00	AS W WD	ACM	84536	injection	SCANIA	228 109	269700		
84537	35,00	62,00	7,00	AS W WD F	ACM	84536	injection pump	SCANIA	310 951		12014830	

dph-no	dim 1	dim 2	dim 3	Style	Material	dph oil seal no.	Application	Type	OEM-NO	Elring	Corteco	Reinz
97435	35,00	62,00	10,00	B	NBR	97435		DB				
94778	35,00	65,00	8,30	A/BS WD	ACM	94777	differential	OPEL	414 537			
116814	35,00	73,00	8/14	HTB5Y	NBR	118409	differential	OPEL	374 595		19033965	
114572	35,00	54,85/61,20	8,9/14,70	SP	NBR	113723	differential	OPEL	1 275 5013			
82770	35,80	68,00	10,00	BS RD	ACM	82769	differential	FIAT	4000 2190		12011293	
109075	36,00	50,00	7,00	AS W RD	FPM	109074	camshaft	PEUGEOT	0236 44	505366	20015457	81-34403-00
93531	36,00	50,00	8,00	A W RD	ACM	93530	camshaft	PEUGEOT	0236 21		07012633	81-26244-10
82216	36,00	54,00	7,00	B	NBR	50806		DB	007 997 7446			
47284	36,00	54,00	7,00	B	NBR	50806		DB	008 997 0146			
47709	36,00	54,00	7,00	B	NBR	50806		DB	011 997 2347			
82449	36,00	54,00	7,00	AW/BS RD	FPM	82448	gearbox	DB	015 997 7747	763691	01019913	
114573	36,00	54,00	7,00	AW/BS RD	FPM	82448	gearbox	DB	017 997 1447	763691	01019913	
96645	36,00	54,00	7,00	AS WD	ACM	96644	differential	RENAULT	77 03 087 087	107794	12015283	
111384	36,00	56,00	10/13,6	A/BS LD W SP	ACM	111393	cranshaft	FIAT	4000 4620		12015267	
46902	36,00	58,00	10,00	B	NBR	47974	rear axle	DB	001 997 3446		01011540	
96330	36,00	58,00	15,00	AS2 WD W	NBR	96329	gearbox	VW	020 301 189 F	525359		
98612	36,00	60,00	10,00	AS W WD	NBR	98611		VW	010 409 255 B			
47447	36,00	62,00	10,00	C	NBR	43231		DB	000 997 4947			
94781	36,00	55/61,00	9/14,5	SP	FPM	94780	drive shaft	OPEL	374 151			
93623	36,51	52,48	8,00	AS W	MVQ	80634	crankshaft	FORD	1 614 762	586730	15012245	81-23056-00
80630	36,51	52,48	8,00	AS W	MVQ	80634	crankshaft	FORD	6 139 049	586730	15012245	81-23056-00
4058	36,51	52,58	7,93	AS	NBR	45544	wheel hub	FORD	1 572 045		12011150	
47646	37,00	61,00	10/14	AW/B RD SP	ACM	47999	differential	DB	008 997 3147	586994	01019477	81-35071-00
93635	37,00	61,00	10/14	AW/B RD SP	ACM	47999	differential	DB	020 997 1947		01019477	
98109	37,00	61,00	10/14	AW/B RD SP	ACM	47999	differential	DB	023 997 9047	268420	01019477	
113902	37,00	62,00	14/10	CY	NBR	113901		Mitsubishi	837719			
47647	37,00	78,30	8,00	AW/B WD SP	ACM	48000	rear axle	DB	008 997 3247	587001	01019475	81-35072-00
69017	37,00	78,30	8,00	AW/B WD	ACM	48000	rear axle	DB	014 997 6047	587001		
84466	37,00	78,30	8,00	AW/B WD SP	ACM	48000	rear axle	DB	020 997 2047	587001	01019475	
95831	37,50	45,00	4,00	BO	NBR	95827	stub axle	MAN	06 56279 0284			
32592	38,00	43,00	3,00	BO	NBR	32154		DB	010 997 1246			
95273	38,00	48,00	5/5,5	BS	NBR	95273		VOLVO				
109077	38,00	50,00	6,00	AS RD	FPM	109076	camshaft	PEUGEOT	0807 24	135140	20018317	81-34146-00
115420	38,00	50,00	6,20	AS RD	FPM	115436	crankshaft	BMW	11 14 7 790 962	135140	19033909	
84169	38,00	50,00	7,00	ASW WD	FPM	36116		BMW	11 12 1 265 435		12015381	

Dimensions

Dimensions

dph-no	dim 1	dim 2	dim 3	Style	Material	dph oil seal no.	Application	Type	OEM-NO	Eling	Corteco	Reinz
116110	38,00	50,00	7,00	ASW WD	FPM	36116	engine	BMW	11 12 1 284 154	586668		
19977	38,00	50,00	7,00	AS W WD	FPM	36116	engine	BMW	11 12 1 285 609	586668	12015381	81-24641-10
109163	38,00	50,00	7,00	A	NBR	70214	crankshaft	DAF	3104 047		12010923	
114575	38,00	50,00	7,00	A	NBR	70214	crankshaft	DB	009 997 3146		12010923	
114574	38,00	50,00	7,00	A	NBR	70214	crankshaft	IVECO	4000 1820		12010923	
69284	38,00	50,00	7,00	A	NBR	70214	crankshaft	SCANIA	123 102		12010923	
110600	38,00	50,00	8,00	A/BS RD	FPM	111535	crankshaft	OPEL	646 271	763918	12014494	
94944	38,00	50,00	8,00	A/BS RD	FPM	111535	crankshaft	OPEL	646 269	763918	12014494	81-28236-00
120047	38,00	50,00	10,50	AS RD	FPM	120046	camshaft	Toyota	90311 38034			
47455	38,00	50,00	10/16	B	NBR	47971		DB	000 997 8147			
46897	38,00	50,00	10/16	B	NBR	47971		DB	001 997 1246			
80414	38,00	50,00	8/5,5	AW/BS RD	MVQ	80414	crankshaft	OPEL	646 269			
114048	38,00	52,00	7,00	AS W RD	FPM	50511	crankshaft	FORD	1 077 686			
117774	38,00	52,00	7,00	B	NBR	20004	crankshaft	IVECO	129 0380		01025734	
50512	38,00	52,00	7,00	AS W RD	FPM	50511	crankshaft	PORSCHE	999 113 33150	525871		81-16847-10
93784	38,00	52,00	7,00	A	NBR	18031		VOLVO	958 861-7			
96053	38,00	52,00	7,00	A	FPM	20567	gearbox automatic	VW	010 409 529 C			
33255	38,00	52,00	10,00	B blue	NBR	51486	manual transmission	BMW	23 12 1 201 390	039780		
46855	38,00	52,00	10,00	B	NBR	51486	gearbox	DB	000 997 1746	039780		
47287	38,00	52,00	10,00	B	NBR	51486	gearbox	DB	008 997 0446	039780		
15266	38,00	52,00	10,00	B	NBR	51486	gearbox	DB	008 997 3346	039780	12011499	
95605	38,00	52,00	10,00	B	NBR	51486	manual transmission	OPEL	724 524			
80992	38,00	52,00	12,00	AS LD	ACM	80991	gearbox	OPEL	724 512			
37033	38,00	54,00	10/11	AS	ACM	94396	differential	BMW	33 12 1 202 126		01025572	
47631	38,00	55,00	7,00	A	NBR	19536	transfer gearbox	DB	007 997 7847		12010926	
80020	38,00	55,00	7,00	A	FPM	41958	transfer gearbox	DB	007 997 8247		12010926	
82217	38,00	62,00	7,00	B	NBR	20008		DB	011 997 5546			
81849	38,00	62,00	10,00	C	NBR	18052		DB	003 997 4746			
35480	38,00	52/58,00	8,50	AS BD	NBR	37098	front axle	VW	311 405 641 B		12011154	
82745	38,00	52/58,00	8,50	AS BD	NBR	37098	front axle	VW	311 405 641A			
95458	38,10	50,00	6,80	AS W SP	NBR	95644	brake camshaft	SCANIA	1 349 089		01031712	
114577	39,00	80,00	13,3/15,6	B SP	MVQ	113714		VOLVO PC	9 143 317			
114578	39,40	52,00	8,00	AS W LD	ACM	113713	transmission, output	VOLVO PC	1 233 756		01030125	
114579	39,40	65,00	10,00	A/BS LD	ACM	113725	transfer gearbox	VOLVO PC	9 183 891		01034110	
109259	39,50	60,00	10,00	A RD	MVQ	109259						

dph-no	dim 1	dim 2	dim 3	Style	Material	dph oil seal no.	Application	Type	OEM-NO	Eling	Corteco	Reinz
96927	40,00	46,00	12,8/17,5	SPSC5	NBR	96926	wheel hub	Toyota	90310-40001		19018296	
3907	40,00	49,60	5,5/7,30	AO LD	MVQ	3906	crankshaft	PEUGEOT	2074 07	314501	46083012	81-21649-00
81806	40,00	50,00	8,00	BS	FPM	81805		DB	009 997 2847			
94863	40,00	52,00	6,00	AS RD	FPM	94862	crankshaft	OPEL	614 822	060120	12015430	
37117	40,00	52,00	7,00	A	MVQ	37111	camshaft	BMW	24 31 1 207 621			
48912	40,00	52,00	7,00	A RD	FPM	48911	gearbox	BMW	24 31 1 218 493			
4059	40,00	52,00	7,00	BS	NBR	37345	front axle	BMW	31 21 1 101 114			
116039	40,00	52,00	7,00	BS	NBR	37345	front axle	BMW	31 21 1 106 225	039926		
116040	40,00	52,00	7,00	BS	NBR	37345	front axle	BMW	31 21 1 106 226	039926		
116041	40,00	52,00	7,00	BS	NBR	37345	front axle	BMW	31 21 1 106 227	039926		
47431	40,00	52,00	7,00	B	NBR	68543	gearbox	DB	000 997 0747	039918		
47410	40,00	52,00	7,00	A	NBR	18068	wheel hub	DB	011 997 8846	321508		
114580	40,00	52,00	7,00	AS W	ACM	114334	gearbox	DB	012 997 8247	221970	01026706	
47418	40,00	52,00	7,00	A	NBR	18068	wheel hub	DB	350 997 7746	321508		
47427	40,00	52,00	7,00	B	NBR	68543	gearbox	DB	608 997 1246	039918		
114581	40,00	52,00	7,00	B	NBR	68543	gearbox	DEUTZ	121 6330	039918		
3897	40,00	52,00	7,00	A	NBR	18068	wheel hub	PEUGEOT	3724 12	321508	12019046	
111626	40,00	52,00	7,00	AS W RD	FPM	111625	gearbox	VW	018 409 399 B			
114582	40,00	52,00	7,00	B	NBR	68543	gearbox	ZF	0634 300 466			
111627	40,00	52,00	7,00	AS W RD	FPM	111625	gearbox	ZF	0734 319 588			
112748	40,00	52,00	9,00	AS W WD	ACM	70817	gearbox	VW	014 409 399 B		12010684	
4056	40,00	52,00	9,00	AS W WD	ACM	70817	gearbox	VW	014 409 399 D	094358	12010684	
94547	40,00	52,00	7/6	A/BS	NBR	94546	wheel hub	VW	8A0 501 641 A		12018360	
96041	40,00	52,00	7/12,7	SP	NBR	96065	wheel hub	VW	8DO 501 641 A		01019205	
117122	40,00	54,00	6,80	A W LD	FPM	117121	differential	PEUGEOT	3121 40		20026877	
117123	40,00	54,00	6,80	A W LD	FPM	117121	differential	RENAULT	77 03 087 209		20026877	
114056	40,00	55,00	6,40	AS W RD	ACM/PTFE	114093	crankshaft	FORD	1 142 359	026750	20029116	81-35554-00
116031	40,00	55,00	7,00	A	NBR	18074	crankshaft	BMW	23 11 1 230 087	277150		
33256	40,00	55,00	7,00	A	NBR	18074	crankshaft	BMW	23 12 1 230 087	277150		
119559	40,00	55,00	7,00	AW/BS RD	FPM	118615	camshaft	Fiat	4643 4591	457220	12016528	
82925	40,00	55,00	7,00	B	NBR	18076	crankshaft	MAN	06 56271 0404		12010932	
116033	40,00	55,00	8,00	AS W LD	ACM	50854	gearbox automatic	BMW	23 12 1 202 727	242993		
50855	40,00	55,00	8,00	AS W LD	ACM	50854	gearbox automatic	BMW	23 12 1 205 340	242993		81-35286-00
113093	40,00	55,00	8,00	AS W LD	ACM	50854	gearbox automatic	BMW	23 12 1 222 771			
46934	40,00	55,00	8,00	B	NBR	18079	gearbox	DB	002 997 2546		12011157	

Dimensions

Dimensions

dph-no	dim 1	dim 2	dim 3	Style	Material	dph oil seal no.	Application	Type	OEM-NO	Eling	Corteco	Reinz
47545	40,00	55,00	8,00	AS LD	ACM	47984		DB	004 997 4047			
47547	40,00	55,00	8,00	AS LD	ACM	47984		DB	004 997 4847			
47548	40,00	55,00	8,00	AS LD	ACM	47984		DB	004 997 5347			
47601	40,00	55,00	8,00	AS LD	ACM	47984		DB	006 997 6847			
47720	40,00	55,00	8,00	AS W LD	ACM	50854	gearbox automatic	DB	011 997 9547			
47721	40,00	55,00	8,00	AS LD	ACM	47984		DB	011 997 9647			
47727	40,00	55,00	8,00	AS	NBR	18078	wheel hub	DB	012 997 3847	039993	12011157	
96443	40,00	55,00	8,00	A/BS LD	FPM	97073		DB	014 997 3547		01019285	
97915	40,00	55,00	8,00	BS WD	ACM	97914	differential	FORD	1 005 745	539580		
112359	40,00	55,00	8,00	AS	NBR	18078	wheel hub	FORD	1 101 837		12011157	
4062	40,00	55,00	8,00	AS	NBR	18078	wheel hub	FORD	1 482 324	039993	12011157	
33296	40,00	55,00	8,00	AS	NBR	18078	wheel hub	FORD	1 579 665	039993	12011157	
47477	40,00	55,00	10,00	B	NBR	18082	transfer gearbox	DB	001 997 7347	044318		
47558	40,00	55,00	10,00	B	NBR	18082	transfer gearbox	DB	004 997 7647			
3913	40,00	55,00	10,00	B	NBR	18082	transfer gearbox	DB	005 997 2046	044318		
36121	40,00	55,00	10,00	B	NBR	18082	transfer gearbox	DB	005 997 8747	044318	01002552	
97153	40,00	56,00	7,00	B RD	ACM	48470	crankshaft	FIAT	4000 0050	325007	12011455	
120290	40,00	56,00	7,00	BS RD	MVQ	95384	crankshaft	FIAT	4000 4950			
112546	40,00	56,00	7,00	B RD	ACM	48470	crankshaft	IVECO	4000 0050	325007	12011455	
48471	40,00	56,00	7,00	B RD	ACM	48470	crankshaft	LADA	2101 100 5034		12011455	81-21087-10
95768	40,00	56,00	10/12	BABSL blue	NBR	95767		DB	003 997 6646			
47266	40,00	58,00	9,00	AS	NBR	43814		DB	007 997 7146			
37122	40,00	58,00	10,00	AS LD	MVQ	37116	gearbox	BMW	24 11 1 207 426			
84218	40,00	58,00	10,00	AS LD	MVQ	37116	wheel hub	BMW	24 11 1 215 465			
109229	40,00	58,00	10,00	AS WD SF	FPM	109411	crankshaft	ZF	0731 319 330			
98170	40,00	58,00	10,00	A W WD	FPM/ACM	117114	rear axle	PEUGEOT	3121 44	504581	20020137	81-38026-00
115081	40,00	58,00	11,30	AS SP WD	ACM	96528	differential	PEUGEOT	3121 27	128250	07015496	
3899	40,00	58,00	10/17	AS2 LD W	NBR	114012	differential	PEUGEOT	3121 09	102946		
112581	40,00	60,00	9/8	A W WD	FPM	112582	crankshaft	SCANIA	1 120 864		01033144	
81455	40,00	60,00	10/12	AS W WD	NBR	81454	differential	VW	02A 301 189		12015556	
47263	40,00	62,00	7,00	A	NBR	18104		DB	007 997 7646			
82926	40,00	62,00	7,00	B	NBR	20011		MAN	06 56271 0406			
109979	40,00	62,00	8,00	AS LD SP	PTFE	109978	crankshaft	DB	166 997 0246	745750	20026275	81-35035-00
82219	40,00	62,00	10,00	B	NBR	18109		DB	000 997 2847			
47013	40,00	62,00	10,00	A	NBR	18107	automatic gearbox	DB	005 997 1146	330809	12010936	

dph-no	dim 1	dim 2	dim 3	Style	Material	dph oil seal no.	Application	Type	OEM-NO	Eling	Corteco	Reinz
36988	40,00	62,00	10,00	A	NBR	18107	automatic gearbox	DB	008 997 9246	330809	12010936	81-21001-20
114583	40,00	62,00	10,00	A	NBR	18107	automatic gearbox	OPEL	744 500	330809	12010936	
69197	40,00	62,00	11,50	A	NBR	18112	wheel hub	VW	111 405 641 A			
48360	40,00	62,00	10/7	A/BS LD	NBR	37532	transfer gearbox	DB	012 997 8747		01019150	
47439	40,00	62,00	12/16	SP	ACM	116560	differential	DB	000 997 2647	219568		
46990	40,00	62,00	12/16	SP	ACM	116560	differential	DB	004 997 2546	219568		
46995	40,00	62,00	12/16	SP	ACM	116560	differential	DB	004 997 4146	219568		
46996	40,00	62,00	12/16	SP	ACM	116560	differential	DB	004 997 5646	219568		
47020	40,00	62,00	12/16	SP	ACM	116560	differential	DB	005 997 4146	219568		
47298	40,00	62,00	12/16	SP	ACM	116560	differential	DB	008 997 5146	219568		
47327	40,00	62,00	12/16	SP	ACM	116560	differential	DB	009 997 2346	219568		
114584	40,00	63,00	8,70	A SP	FPM	113721	automatic gearbox	VOLVO PC	6 843 112		19033885	
83005	40,00	65,00	10,00	AS blue	NBR	18118	transmission shaft	VW	015 301 227 A			
47609	40,00	70,00	13,00	special	FPM	47986	40x70x13/20x40x68x8,3/12	DB		007 997 0947		12015262
47627	40,00	70,00	13,00	SP	FPM	47986	40x70x13/20x40x68x8,3/12	DB		007 997 6347		12015262
47628	40,00	70,00	13,00	SP	FPM	47986	40x70x13/20x40x68x8,3/12	DB		007 997 6547		12015262
47731	40,00	70,00	13,00	special	FPM	47986	40x70x13/20+40x68x8,3/12	DB		013 997 1847		
47610	40,00	70,00	7/8	B	FPM	47987	differential	DB	007 997 1047			
47629	40,00	70,00	7/8	B	FPM	47987	differential	DB	007 997 6647			
47630	40,00	70,00	7/8	B	FPM	47987	differential	DB	007 997 6747		12015261	
47650	40,00	70,00	7/8	B	FPM	47987	differential	DB	008 997 3647		12015261	
47657	40,00	70,00	7/8	B	FPM	47987	differential	DB	008 997 8147		12015261	
109112	40,00	70,00	11/15	A RD SP	ACM	109227		DB	022 997 9947	745720	01025661	
47491	40,00	70,00	12/16	SP RD	ACM	48005	rear axle	DB	002 997 2147	312444		
47513	40,00	70,00	12/16	SP RD	ACM	48005	rear axle	DB	003 997 1147	312444		81-35073-00
47546	40,00	70,00	12/16	BS RD	FPM	48015	differential	DB	004 997 4747		12015258	
47556	40,00	70,00	12/16	BS RD	FPM	48015		DB	004 997 7247		01019450	
47014	40,00	70,00	12/16	SP RD	ACM	48005	rear axle	DB	005 997 1246	312444		81-35073-00
47372	40,00	70,00	12/16	SP RD	ACM	48005	rear axle	DB	010 997 7846	312444		81-35073-00
47378	40,00	70,00	12/16	SP RD	ACM	48005	rear axle	DB	011 997 0446	312444	12015258	81-35073-00
81898	40,00	70,00	12/16	SP RD	ACM	48005	rear axle	DB	014 997 4947	312444	12015258	
84348	40,00	70,00	12/16	SP RD	ACM	48005	rear axle	DB	020 997 2147			
97947	40,00	52/56,00	9,00	AS SF	NBR	97945	wheel hub	VW	111 405 641 C			
4060	40,00	52/58,00	7,5/6	AS WD W	NBR	37227	rear axle	VW	321 501 641	045772	12011153	
37226	40,00	52/58,00	7,5/6	AS WD W	NBR	37227	rear axle	VW	357 501 641 B			

Dimensions

Dimensions

dph-no	dim 1	dim 2	dim 3	Style	Material	dph oil seal no.	Application	Type	OEM-NO	Elring	Corteco	Reinz
51456	40,00	52/62,00	8,50	AW SP	NBR	51455	front & rear axle	OPEL	328 410		12011155	
4061	40,00	52/62,00	8,50	AW SP	NBR	51455	front & rear axle	OPEL	328 637	043923	12011155	81-31435-00
109228	40,00	70/76,00	11/13,5	AW/BS RD SF	ACM	109304	differential	DB	025 997 0047	152940	01029803	
96933	41,00	47,00	17,00	SPSC5	NBR	96932	wheel hub	Toyota	90310-41001		19026768	
95832	42,00	49,00	4,00	BO	NBR	95828	stub axle	MAN	06 56279 0289			
94804	42,00	52,00	5,00	B OF	FPM	97353	camshaft	MAN	06 56279 0262		01030090	
80653	42,00	52,00	7,5/8	A/BS W RD	FPM	80652	crankshaft	BMW	11 14 1 714 617	748889	12014607	81-27556-00
114047	42,00	53,00	7,00	AS RD W	FPM	97916	crankshaft	FORD	1 067 029	467860	01015834	
97917	42,00	53,00	7,00	AS RD W	FPM	97916	crankshaft	FORD	1 663 822	467860	01015834	81-33581-00
115529	42,00	54,00	6,00	AS RD	FPM/ACM	112276	crankshaft	OPEL	440 2706	157200	12018755	81-34413-00
112260	42,00	54,00	6,00	AS RD	FPM/ACM	112276	crankshaft	RENAULT	77 00 103 245	157200	12018755	81-34413-00
97379	42,00	55,00	7,00	AS W RD	FPM/ACM	97538	FPM/ACM crankshaft	OPEL	638 199	127610	20020389	81-33489-00
95663	42,00	55,00	7,00	A W RD	MVQ	96335	gearbox automatic	VW	003 519 089 D	225614		
116336	42,00	55,00	7,00	AW/BS RD	PTFE/ACM	116335	crankshaft	VW	06C 103 085			81-36024-00
93628	42,00	55,00	7,00	B WD	NBR	93628	wheel hub					
112883	42,00	55,00	8,00	AS W WD	FPM	112883	steering ZF	ZF				
47511	42,00	55,00	9,00	B	FPM	48010	front axle	DB	003 997 0647			
47032	42,00	55,00	9,00	B	FPM	48010	front axle	DB	005 997 7446			
47413	42,00	55,00	9,00	B	FPM	48010	brake cam shaft	DB	011 997 9946			
84201	42,00	55,00	9,00	B	FPM	48010	front axle	DB	012 997 3747		01017009	
47417	42,00	55,00	9,00	B	FPM	48010	front axle	DB	350 997 7446			
96525	42,00	55,00	9,00	B	FPM	48010	front axle	MAN	06 56279 0095			
81191	42,00	55,00	9,00	B	FPM	48010	front axle	MAN	06 56279 0297		01017009	
84396	42,00	55,00	9,00	B	FPM	48010	brake cam shaft	MAN	81 96501 0842			
111537	42,00	55,00	10,00	BS	NBR	111536	gearbox	OPEL	714 400			
94774	42,00	55,00	10/8	A/BS LD	FPM	94773	gearbox	OPEL	714 408			
94685	42,00	56,00	7,00	AS	NBR	94735	water pump	DAF	0213 966	344400		
46969	42,00	56,00	7,00	AS W	NBR	94735	water pump	DB	003 997 5146	344400	12010943	81-51109-00
47560	42,00	56,00	7,00	AS	NBR	94735	water pump	DB	005 997 0047	344400	12010943	
95572	42,00	56,00	7,00	AS W RD	FPM	82475	differential	DEUTZ	117 4560		12014404	
37641	42,00	56,00	7,00	AS RD W	MVQ	37639	camshaft	FORD	1 614 994		15011250	81-51109-20
96247	42,00	56,00	7,00	AS W RD	FPM	82475	differential	FORD	1 669 254	757497	12014404	
81088	42,00	56,00	7,00	AS RD W	MVQ	37639	camshaft	FORD	6 078 801		15011250	81-51109-20
80632	42,00	56,00	7,00	AS W RD	FPM	82475	differential	FORD	6 165 498	757497	12014404	81-51109-30
116121	42,00	58,00	7,00	BS	NBR	37347	rear axle	BMW	33 41 1 106 213	040304		

dph-no	dim 1	dim 2	dim 3	Style	Material	dph oil seal no.	Application	Type	OEM-NO	Elring	Corteco	Reinz
4063	42,00	58,00	7,00	BS	NBR	37347	rear axle	BMW	33 41 3 404 161	040304	12012129	
47480	42,00	58,00	7,00	BS	NBR	37347	rear axle	DB	001 997 8047	010197		
4542	42,00	58,00	7,00	BS	NBR	37347	rear axle	DB	003 997 0547	010197	01017010	
48050	42,00	58,00	7,00	BS	NBR	37347	rear axle	DB	009 997 3046	010197		
109262	42,00	58,00	7,00	BS	NBR	37347	brake cam shaft	DB	012 997 4147			
37247	42,00	58,00	7,00	BS	NBR	37347	rear axle	DB	014 997 2247			
47416	42,00	58,00	7,00	BS	NBR	37347	rear axle	DB	350 997 7346	010197		
80281	42,00	58,00	7,00	BS	NBR	37347	rear axle	MAN	06 56279 0114	010197		
35264	42,00	58,00	7,00	BS	NBR	37347	rear axle	MAN	06 56279 0133	010197		
84546	42,00	58,00	7,00	B	NBR	19600	camshaft	MAN	06 56279 0310			
81590	42,00	58,00	7,00	BS	NBR	37347	brake cam shaft	MAN	06 56279 0350			
84198	42,00	58,00	7,00	BS	NBR	37347	rear axle	MAN	81 96501 0843	010197		
82477	42,00	58,00	10,00	AS RD	FPM	82478	crankshaft	FORD	6 135 093			
82482	42,00	60,00	8,00	A W RD	ACM	59256	crankshaft	FORD	1 576 424			81-27333-00
82479	42,00	60,00	8,00	A W RD	ACM	59256	crankshaft	PEUGEOT	0514 11	767921	07011550	81-27333-00
46955	42,00	60,00	10,00	A	NBR	18168	crankshaft	DB	003 997 1646	040320	12010944	
47279	42,00	60,00	10,00	B	NBR	18169		DB	007 997 8946	040339		
35211	42,00	60,00	10,00	B	NBR	18169		MAN	81 96501 0448	040339		
81457	42,00	62,00	6,00	AS W	NBR	81456	rear axle	SCANIA	202 288			
81658	42,00	62,00	7,00	AS W RD	FPM	81657	camshaft	PEUGEOT	032 612			81-25926-10
109055	42,00	62,00	7,00	AS W RD	FPM/ACM	109055	camshaft	PEUGEOT	032 612	508233	20015456	
109143	42,00	62,00	10,00	AS RD	ACM	35050	crankshaft	ALFA	60735515		12013896	
96322	42,00	62,00	10,00	AS RD	ACM	35050	crankshaft	BMW	11 14 1 255 010		12013896	
109119	42,00	62,00	10,00	AS RD	ACM	35050	crankshaft	BMW	11 14 1 715 101		12013896	
82210	42,00	62,00	10,00	C	NBR	18177		DB	002 997 0846			
95573	42,00	62,00	10,00	AS RD	ACM	35050	crankshaft	DEUTZ	117 5787			
83895	42,00	62,00	10,00	B RD	ACM	81352	crankshaft	IVECO	4000 0583		12011459	
114585	42,00	62,00	10,00	A	NBR	18175	wheel hub	MAN	06 56279 0035	040355	12010946	
117339	42,00	62,00	10,00	AS RD	ACM	35050	gearbox	MAN	81 96502 0200		12013896	
114586	42,00	62,00	10,00	AS RD	ACM	35050	crankshaft	PEUGEOT	0514 21	040363	12013896	81-21001-10
3898	42,00	62,00	10,00	A	NBR	18175	wheel hub	PEUGEOT	3724 08	040355	12011236	
114587	42,00	62,00	10,00	AS RD	ACM	35050	crankshaft	RENAULT	79 10 247 576	040363	12013896	
33551	42,00	62,00	10,00	AS RD	ACM	35050	crankshaft	VOLVO	247 576		12013896	81-21001-10
33552	42,00	62,00	10,00	AS RD	ACM	35050	crankshaft	VOLVO PC	1 218 034	040363	12013896	
35051	42,00	62,00	10,00	AS RD	ACM	35050	crankshaft	VW	021 105 247 A	040363	12013896	81-21001-10

Dimensions

Dimensions

dph-no	dim 1	dim 2	dim 3	Style	Material	dph oil seal no.	Application	Type	OEM-NO	Elring	Corteco	Reinz
35511	42,00	62,00	10,00	AS RD	ACM	35050	crankshaft	VW	021 105 247 B	040363	12013896	81-21001-10
115876	42,00	62,00	12,00	AW/BS RD	FPM	15245	crankshaft	BMW	11 14 1 715 098	586641		
115877	42,00	62,00	12,00	AW/BS RD	FPM	15245	crankshaft	BMW	11 14 1 715 099	586641		
15257	42,00	62,00	12,00	AW/BS RD	FPM	15245	crankshaft	BMW	11 14 1 715 100	586641		81-16004-10
112363	42,00	62,00	12,00	AW/BS RD	FPM	15245	wheel hub	FORD	6 042 618			
113751	42,00	62,00	10/8	A W RD	FPM	113750	gearbox	ZF	0734 319 713			
113754	42,00	62,00	10/8	A W RD	FPM	113750	gearbox	ZF	0750 111 476			
47265	42,00	65,00	10,00	A	NBR	18181		DB	007 997 6446			
47741	42,00	65,00	10,00	A	NBR	18181		DB	186 997 0047			
112610	42,00	65,00	10,00	AW BS RD	FPM	112609	crankshaft	IVECO	4010 0870		12016489	
35108	42,00	65,00	10,00	C	NBR	18183		MAN	06 56279 0014			
46886	42,00	65,00	12,00	AS 15 Grad	ACM	37404	differential	DB	000 997 5146	706035	19016590	
46900	42,00	65,00	12,00	C	FPM	46901		DB	001 997 1946			
46961	42,00	65,00	12,00	C	FPM	46901		DB	003 997 3546			
47276	42,00	65,00	13,00	B	FPM	47278		DB	007 997 8846			
47747	42,00	65,00	13,00	B	FPM	47278		DB	303 997 1247			
47754	42,00	65,00	13,00	B	FPM	47278		DB	304 997 1247			
114588	42,00	65,00	12/8	AW/BS RD	ACM	82398	crankshaft	IVECO	4000 0010		12011460	
93435	42,00	66,00	6,00	BS W RD	FPM/ACM	93433	crankshaft	PEUGEOT	0514 72	505740	20018081	81-31863-00
109150	42,00	66,00	8/7	AS W RD	MVQ	59260	crankshaft	CITROEN	9606 8980			
59261	42,00	66,00	8/7	AS W RD	MVQ	59260	crankshaft	PEUGEOT	0514 38			
37513	42,00	67,00	17,60	AS WD	NBR	37512	gearbox	VW	002 301 189 C	045322		
112656	42,00	72,00	8,00	AS W WD	ACM	112655	crankshaft	SCANIA	1 109 871		12014829	
70455	42,00	72,00	8,00	AS W WD	ACM	112655	crankshaft	SCANIA	170 226		12014829	
114589	42,00	72,00	8,00	AS W WD	ACM	112655	crankshaft	SCANIA	310 953		12014829	81-25136-10
35084	42,00	72,00	10,00	AS	NBR	19614	gearbox	VW	002 301 189			
117966	42,00	72,00	10/12	A/BS SP	FPM	117966						
95381	42,00	56/63,00	7,00	A RD SP	MVQ	95381	crankshaft	FIAT	4000 0320			
97150	42,00	56/63,00	7,20	B RD	ACM	112611	crankshaft	FIAT	4000 0320	440770	12011279	
96052	42,00	58/60,00	19,5/7	B SP RD	MVQ	96050	gearbox	VW	010 409 568 A	249173		
61237	43,00	58,00	7,00	A/B RD	FPM	37533	automatic gearbox	DB	010 997 4847			
84412	43,00	58,00	7,00	A/B RD	FPM	37533	automatic gearbox	DB	010 997 4947	466042	01020045	
48185	43,00	58,00	7,00	A/B RD	FPM	37533	gearbox automatic	DB	010 997 5047	466042	01020045	
69527	44,00	58,00	7,00	B	NBR	80466		VOLVO	949 573			
118872	44,00	58,40	10/8	A	NBR	98068		PORSCHE	999 113 03850			

dph-no	dim 1	dim 2	dim 3	Style	Material	dph oil seal no.	Application	Type	OEM-NO	Elring	Corteco	Reinz
47530	44,00	60,00	8,00	B RD LA	MVQ	15241	gearbox	DB	003 997 7247	319104		
47531	44,00	60,00	8,00	B RD LA	MVQ	15241	gearbox	DB	003 997 7347	319104		
15265	44,00	60,00	8,00	B RD LA green	MVQ	15241	gearbox	DB	004 997 0547	319104		
47249	44,00	60,00	8,00	B RD LA	MVQ	15241	gearbox	DB	007 997 0246	319104		
47393	44,00	60,00	8,00	B RD LA	MVQ	15241	gearbox	DB	011 997 3946	319104		
95835	44,00	60,00	10,00	AS W RD	FPM	80654	crankshaft	BMW	11 14 1 308 342	761796	12014608	
114591	44,00	60,00	10,00	combi	PTFE	114335	crankshaft	BMW	11 14 1 435 848		20019548	81-28498-10
96714	44,00	60,00	10,00	combi	PTFE	114335	crankshaft	BMW	11 14 1 439 570	214680	20019548	81-28498-10
80655	44,00	60,00	10,00	AS W RD	FPM	80654	crankshaft	BMW	11 14 1 721 560	761796	12014608	81-28498-00
114590	44,00	60,00	10,00	AS W RD	FPM	80654	crankshaft	LANCIA	46108224		12014608	
104477	44,00	62,00	10,00	A/BS RD W	FPM	104499	crankshaft	BMW	11 14 1 312 007	757217		81-36496-00
84216	44,00	67,00	10,00	AS WD	ACM	84215	differential	BMW	33 13 1 206 111	095311	01020317	
93723	44,00	67,00	10,00	AS WD	ACM	84215	differential	BMW	33 13 1 214 100	095311	01020317	81-29411-00
94776	44,00	72,00	10/16	B RD SP	ACM	94775	differential	OPEL	406 777			
113963	44,00	85,00	10,00	A W WD blue	NBR	113962	rear axle	RVI	5000 391 891		07016685	
80737	44,45	57,15	6,75	AS RD	ACM	80736	crankshaft	VOLVO PC	6 842 272			
108806	44,45	57,15	6,75	AS RD	FPM	108806	crankshaft	VOLVO PC	6 842 272	135180	15018287	81-33634-00
95457	44,45	60,00	7,00	BS SP	NBR	95642	crankshaft	SCANIA	1 345 278		01031705	
96311	44,45	60,00	10/15	SP	NBR	95643	brake camshaft	SCANIA	1 345 279		01034657	
94512	44,45	60,33	9,50	AS	NBR	94511	wheel hub	FORD	1 536 229		12012128	
81493	44,50	62,00	8,00	AS2	NBR	81492	rear axle	VW	113 501 315 G			
50868	44,50	62,00	10/7	AS2 WD	NBR	95590	rear axle	VW	113 501 315 H	042803	12011164	
4064	44,70	54,00	5,5/9,1	B SP	NBR	82154	wheel hub	RENAULT	77 03 087 071		12011541	
84478	45,00	50,00	3,00	BO	NBR	42762	hub axle	DB	008 997 7746		01020632	
95044	45,00	52,00	3,00	BO	NBR	95043		DB	002 997 8147		01029642	
93150	45,00	52,00	4,00	BO	NBR	48498	crankshaft	MAN	06 56279 0278		01025733	
117352	45,00	55,00	7,00	B WD	NBR	93224	stub axle	EVOBUS	4 751 394 000			
111760	45,00	55,00	7,00	B WD	NBR	93224	crankshaft	RVI	5000 787 085		07002931	
114592	45,00	55,00	7,00	B RD	ACM	93690	crankshaft	SCANIA	244 710		01026396	
46857	45,00	58,00	7,00	A	NBR	18210		DB	000 997 2046			
47435	45,00	60,00	7,00	A	NBR	70213		DB	000 997 1847			
68810	45,00	60,00	7,00	A	NBR	70213	crankshaft	SCANIA	120 828	040606	12010950	
47334	45,00	60,00	8,00	A	NBR	18213		DB	009 997 4846			
118998	45,00	60,00	8,00	AS RD	ACM	109584	crankshaft	DEUTZ	417 5435			
120107	45,00	60,00	8,00	AS RD	FPM	120108		Ferrari	133628		15014894	

Dimensions

Dimensions

dph-no	dim 1	dim 2	dim 3	Style	Material	dph oil seal no.	Application	Type	OEM-NO	Elring	Corteco	Reinz
61261	45,00	60,00	8,00	AS W WD	ACM	61260	gearbox	VW	018 409 399	063665	12017270	
70818	45,00	60,00	8,00	AS WD W	ACM	61260	gearbox	VW	088 409 399 D	063665		
47442	45,00	60,00	10,00	C	NBR	18218		DB	000 997 4247			
3896	45,00	60,00	10,00	A	NBR	18215	wheel hub	PEUGEOT	3724 18	048410	12010951	
15255	45,00	60,00	9/7	AS RD	ACM	36895	crankshaft	OPEL	638 187	590762	12012250	81-19195-00
80039	45,00	60,00	9/7	AS RD	ACM	36895	crankshaft	OPEL	638 193	590762	12012250	
114593	45,00	60,00	9/7	AS RD	ACM	36895	crankshaft	RENAULT	77 03 087 079		12012250	
109530	45,00	60,00	6,5/8	B OF SF	NBR	112601	steering	SCANIA	1 343 372		01026542	
116113	45,00	62,00	7,00	BS	NBR	37346	front axle	BMW	31 21 1 106 220	040673		
4065	45,00	62,00	7,00	BS	NBR	37346	front axle	BMW	31 21 2 634 108	040673		
116114	45,00	62,00	7,00	BS	NBR	37346	front axle	BMW	32 21 2 634 108	040673		
46992	45,00	62,00	7,00	B V	NBR	47956		DB	004 997 2946			
114594	45,00	62,00	8,00	AW/BS RD	ACM	114336	crankshaft	VOLVO	1 546 480	390010	01030097	
47429	45,00	62,00	10,00	A	NBR	18223		DB	000 997 0047			
47755	45,00	62,00	10,00	A	NBR	18223	crankshaft	DB	304 997 1347	367206	12010954	
117146	45,00	62,00	10,00	A	MVQ	82796	crankshaft	DEUTZ	242 7066			
94250	45,00	62,00	10,00	A/BS F	FPM	94249	engine	DEUTZ	418 2347	462994		
114595	45,00	62,00	10,00	A	NBR	18223	crankshaft	MAN	06 56279 0039	367206	12010954	
35201	45,00	62,00	10,00	A	NBR	18223		MAN	81 96501 0032			
4142	45,00	62,00	10,00	A	NBR	18223	crankshaft	PEUGEOT	3345 10		12010954	
95805	45,00	62,00	10,00	CS	NBR	18227		PORSCHE	999 113 07750			
95804	45,00	62,00	10,00	CS	NBR	18227		PORSCHE	999 113 23540			
50682	45,00	62,00	10,00	CS	NBR	18227	wheel hub	VW	477 405 641	043451		
82220	45,00	62,00	12,00	C	NBR	18230		DB	000 997 6547			
18228	45,00	62,00	12,00	A	NBR	18228	crankshaft	PEUGEOT	3345 10			
46931	45,00	62,00	10/12	BS	NBR	15244	front axle	DB	002 997 2246			
46932	45,00	62,00	10/12	BS	NBR	15244	front axle	DB	002 997 2346			
46865	45,00	62,00	10/12	BS	NBR	15244	front axle	DB	002 997 8246			
3912	45,00	62,00	10/12	BS	NBR	15244	front axle	DB	003 997 9346		01019288	
47343	45,00	62,00	10/12	BS	NBR	15244	front axle	DB	009 997 8246			
84231	45,00	62,00	6,5/7	A/B WD	ACM	84230	gearbox	VW	087 409 529 B	091511	01026543	
81050	45,00	62,00	7,5/8,8	A OF SP	NBR	81050		ZF				
37517	45,00	64,00	12/7	SP WD	NBR	48029	front axle	DB	011 997 5147	578134	12012039	81-35076-00
47714	45,00	64,00	12/7	SP WD	NBR	48029	front axle	DB	011 997 6147	578134		81-35076-00
114596	45,00	65,00	8,00	A	NBR	18232	crankshaft	SCANIA	244 249		12010955	

dph-no	dim 1	dim 2	dim 3	Style	Material	dph oil seal no.	Application	Type	OEM-NO	Elring	Corteco	Reinz
114597	45,00	65,00	8,00	A/BS RD	ACM	114337	crankshaft	VOLVO	1 543 936		12017221	
70483	45,00	65,00	9,00	BS RD LA	ACM	81126	gearbox	SCANIA	314 063	325562	12011970	
116115	45,00	65,00	10,00	AW BS RD	FPM	95149	rear axle	BMW	33 12 1 202 121	216046	20020503	
116116	45,00	65,00	10,00	AW BS RD	FPM	95149	rear axle	BMW	33 12 1 202 124	216046		
116117	45,00	65,00	10,00	AW BS RD	FPM	95149	rear axle	BMW	33 12 1 202 125	216046		
116118	45,00	65,00	10,00	AW BS RD	FPM	95149	rear axle	BMW	33 12 1 204 231	216046		
112419	45,00	65,00	10,00	AW BS RD	FPM	95149	rear axle	BMW	33 12 1 204 232	216046		
46856	45,00	65,00	10,00	B	NBR	51487	gearbox	DB	000 997 1846	040843		
3911	45,00	65,00	10,00	B	NBR	18235		DB	002 997 4246			
46947	45,00	65,00	10,00	B	NBR	18235		DB	002 997 6246			
37515	45,00	65,00	10,00	AW/B WD	ACM	37514	rear axle	DB	002 997 6747			
94659	45,00	65,00	10,00	AW/B WD	ACM	37514	rear axle	DB	003 997 1247			
82226	45,00	65,00	10,00	AW/B WD	ACM	37514	rear axle	DB	009 997 2247			
47735	45,00	65,00	10,00	AW/B WD	ACM	37514	rear axle	DB	014 997 6247		01019154	
114598	45,00	65,00	10,00	C	NBR	18236	crankshaft	DEUTZ	115 4490		01003181	
112544	45,00	65,00	10,00	AW/BS RD	FPM	95149	crankshaft	DEUTZ	241 4248		01026520	81-27390-10
96575	45,00	65,00	10,00	AW/BS RD	FPM	95149	engine	DEUTZ	414 4843			
84557	45,00	65,00	10,00	AW/BS RD	MVQ	82795	engine	DEUTZ	418 0665			
114599	45,00	65,00	10,00	AW/BS RD	FPM	95149	crankshaft	DEUTZ	418 7438	763781	01026520	81-27390-10
117397	45,00	65,00	10,00	AS	NBR	18234	crankshaft	IVECO	3 345 907		12011168	
112550	45,00	65,00	10,00	B	NBR	51487	gearbox	IVECO	4000 0370		12001744	
114600	45,00	65,00	10,00	B	NBR	51487	gearbox	MAN	06 56279 0003	040843	12011509	
114601	45,00	65,00	10,00	SP	PTFE	114338		CUMMINS	200307			
81462	45,00	65,00	10/8	A/BS LD	FPM	81461	gearbox	SCANIA	388 528		12015765	
47540	45,00	67,00	8,00	AS W RD	FPM	36206	crankshaft	DB	004 997 1547		12015258	
47671	45,00	67,00	8,00	ASW RD	FPM	36206	crankshaft	DB	009 997 8947			
36666	45,00	67,00	8,00	AS W RD	FPM	36206	crankshaft	DB	010 997 0947		12012248	
36227	45,00	67,00	8,00	ASW RD	FPM	36206	crankshaft	DB	010 997 3347		12012248	
82458	45,00	67,00	8,00	ASW RD	FPM	36206	crankshaft	DB	018 997 5247	914924		
114602	45,00	67,00	8,00	ASW RD	PTFE	114339	crankshaft	DB	021 997 1847	424841	20026532	
115782	45,00	67,00	8,00	AS W RD	PTFE	114339	crankshaft	DB	021 997 7647	424841		81-26248-10
114603	45,00	67,00	8,00	ASW RD	PTFE	114339	crankshaft	DB	023 997 8447	424841	20026532	
48712	45,00	67,00	8,00	ASW RD	FPM	36206	crankshaft	DB	120 997 0346	914924	12012248	81-26248-00
47699	45,00	67,00	10,00	ASW RD	FPM	48027	crankshaft	DB	010 997 8947			
47510	45,00	67,00	12/13	A/BS RD W	ACM	50166	crankshaft	DB	003 997 0347			

Dimensions

Dimensions

dph-no	dim 1	dim 2	dim 3	Style	Material	dph oil seal no.	Application	Type	OEM-NO	Elring	Corteco	Reinz
47677	45,00	67,00	12/13	A/BS RD W	ACM	50166	crankshaft	DB	010 997 3447			
47552	45,00	67,00	12/13	A/BS RD W	ACM	50166	crankshaft	DB	004 997 6647	287202		
47280	45,00	67,00	12/13	A/BS RD W	ACM	50166	crankshaft	DB	007 997 9746			
47652	45,00	67,00	12/13	A/BS RD W	ACM	50166	crankshaft	DB	008 997 4047	287202		
47304	45,00	67,00	12/13	A/BS RD W	ACM	50166	crankshaft	DB	008 997 7046	287202		
47461	45,00	67,00	12/13,00	BS RD LA	FPM	36211		DB	001 997 0947	287202		
47462	45,00	67,00	12/13,00	BS RD LA	FPM	36211		DB	001 997 1047	287202		
47591	45,00	67,00	12/13,00	BS RD LA	FPM	36211	crankshaft	DB	006 997 1247	305529	12011247	81-21023-30
47654	45,00	67,00	12/13,00	BS RD LA	FPM	36211	crankshaft	DB	008 997 5247	305529	12012247	81-21023-30
97168	45,00	72,00	10,00	BS LD LA F	FPM	97167	crankshaft	DEUTZ	414 4856			81-25887-00
94732	45,00	72,00	10,00	AS	NBR	94732	crankshaft					
94690	45,00	72,00	15,00	AS2W WD	NBR	37510	steering	DEUTZ	115 3906			
37511	45,00	72,00	15,00	AS2W WD	NBR	37510	differential	VW	091 301 189 A	277525		
94690	45,00	72,00	15,00	AS2W WD	NBR	37510	differential	VW	091 301 189 C			
15264	45,00	74,50	12/14,50	AS W RD	ACM	15238	crankshaft	DB	004 997 6846	284742		
47246	45,00	74,50	12/14,50	A SP RD	FPM/ACM	47997	crankshaft	DB	006 997 8846			
47641	45,00	74,50	12/14,50	A SP RD	FPM/ACM	47997	crankshaft	DB	008 997 1647	309028	12010743	
47296	45,00	74,50	12/14,50	A SP RD	FPM/ACM	47997	crankshaft	DB	008 997 2346	309028		
51407	45,00	75,00	10/8	A/BS RD	ACM	51406	differential	BMW	33 12 1 212 461		01027755	
82222	45,00	85,30	9,5/14,00	A W WD	ACM	6343	differential	DB	003 997 5347			
15260	45,00	85,30	9,5/14,00	A W WD	ACM	6343	differential	DB	003 997 8347	467995	01019449	
37520	45,00	85,30	9,5/14,00	A W WD	ACM	6343	differential	DB	011 997 8847	587915		81-35148-00
84206	45,00	85,30	9,5/14,00	A W WD	ACM	6343	differential	DB	014 997 6147			
93544	45,00	85,30	9,5/14,00	A W WD	ACM	6343	differential	DB	020 997 2347		01020315	
112364	45,00	85,30	9,5/14,00	A W WD	ACM	6343	differential	DB	022 997 9847		01020315	
82508	45,00	85,30	9,5/18,5	A W WD	ACM	82404		DB	006 997 6747		01019454	
46942	45,00	62/68,00	10/8	AS BD	NBR	47953		DB	002 997 5046			
46981	45,00	62/68,00	10/8	AS BD	NBR	47953	wheel hub	DB	004 997 0146	044369		81-35288-00
46982	45,00	62/68,00	10/8	AS BD	NBR	47953	wheel hub	DB	004 997 0446	044369		81-35288-00
47005	45,00	62/68,00	10/8	AS BD	NBR	47953	wheel hub	DB	004 997 8146	044369		
37349	45,00	62/68,00	10/12,00	AS BS	NBR	37348	front axle	DB	005 997 5046			
46819	45,00	67/72	10/14	AS RD SP W	NBR	46819	crankshaft	DB	010 997 3447			
47636	45,00	67/72,00	12/13	AS W RD	FPM	47996	crankshaft	DB	008 997 0447	284785	12012247	
37326	45,00	67/72,00	12/13	AS W RD	FPM	47996	crankshaft	DB	008 997 0547	284785	12012247	
47733	45,00	67/72,00	10/14,50	AS RD SP W	NBR	46819	crankshaft	DB	013 997 6847			

dph-no	dim 1	dim 2	dim 3	Style	Material	dph oil seal no.	Application	Type	OEM-NO	Elring	Corteco	Reinz
80579	45,00	68/72,20	19,50	SP	MVQ	80578	gearbox automatic	VW	001 301 083	043958		
47460	45,00	74,5/79,5	12/13	A SP RD	FPM/ACM	47997	crankshaft	DB	001 997 0847	309028		
47019	45,00	74,5/79,5	12/13	A SP RD	FPM/ACM	47997	crankshaft	DB	005 997 3846	309028		81-17328-20
47588	45,00	74,5/79,5	12/13	A SP RD	FPM/ACM	47997	crankshaft	DB	005 997 9047	312010	12010743	
47242	45,00	74,5/79,5	12/13	A SP RD	FPM/ACM	47997	crankshaft	DB	006 997 8046	309028		
47640	45,00	74,5/79,5	12/13	A SP RD	FPM/ACM	47997	crankshaft	DB	008 997 1547	309028	12010743	
36153	45,00	74,5/79,5	12/13	A SP RD	FPM/ACM	47997	crankshaft	DB	009 997 4547	309028	12010743	
48037	45,00	74,5/79,5	12/13	A SP RD	FPM/ACM	47997	crankshaft	DB	009 997 8547	312010	12010743	
47707	45,00	74,5/79,5	12/13	A SP RD	FPM/ACM	47997	crankshaft	DB	011 997 2247		12010743	81-17328-20
47486	45,00	74,5/79,50	12/13	A SP RD	FPM/ACM	47997	crankshaft	DB	002 997 0847	309028	12010743	
109900	45,00	98,3/116,00	10/16,8	SP	NBR	109901		DB	025 997 2647		01031604	
112366	45,00	98,3/116,00	10/16,8	SP	NBR	109901	differential	DB	210 997 0246			
35112	46,00	62,00	12,00	C	NBR	35113		MAN	06 56279 0041			
47643	46,00	64,00	8,00	B RD	FPM	47998	gearbox	DB	008 997 1947	283827		
47355	46,00	64,00	8,00	B RD	FPM	47998	gearbox	DB	010 997 2946	283827	12015259	
47367	46,00	64,00	8,00	B RD	FPM	47998	gearbox	DB	010 997 5946	283827		
47700	46,00	64,00	8,00	B RD	FPM	47998	gearbox	DB	010 997 9447	283827	12015259	
95611	46,00	64,00	8,00	B RD	FPM	47998	gearbox	DB	015 997 0347	701343	12015259	
46880	46,00	68,00	12,00	C	NBR	95185		DB	000 997 0246			
47286	46,00	68,00	12,00	C	NBR	95185	gearbox	DB	008 997 0246	008362		
114604	46,00	68,00	12,00	A/BS RD	FPM	114340	gearbox	DB	010 997 2146		01019885	
112365	47,00	78/82,00	11,00	A/BS SP RD W	ACM	109482	differential	DB	020 997 6347		01019476	
109481	47,00	78/82,00	11,00	A/BS SP RD W	ACM	109482	differential	DB	024 997 9947		01031603	
97925	47,60	66,70	11,30	AS W RD	AEM/PTFE	111282	crankshaft	FORD	1 087 567	516406	15015977	
95603	47,62	80,26	6,8/13,3	A SP W RD	FPM	95622	differential	OPEL	406 774		01031231	
119864	47,62	80,26	6,8/13,3	A SP W RD	FPM	95622	differential	VOLVO	6 877 226-8		01031231	
113877	47,63	65,07	6,35	A WD SF	FPM	114111	crankshaft	IVECO	798 0285		12010744	
116042	48,00	62,00	7,00	BS	NBR	19660	rear axle	BMW	31 21 1 118 478	277223		
116043	48,00	62,00	7,00	BS	NBR	19660	rear axle	BMW	31 21 1 119 139	277223		
80575	48,00	62,00	7,00	BS	NBR	19660	rear axle	BMW	31 21 1 119 200	277223		
116112	48,00	62,00	7,00	BS	NBR	19660	rear axle	BMW	31 21 1 125 912	277223		
111530	48,00	62,00	7,00	AS WD	ACM	111529	differential	VW	084 409 189 B		12015555	
47632	48,00	62,00	8,00	A	ACM	47994		DB	007 997 8347			
47411	48,00	62,00	8,00	A	ACM	47994		DB	011 997 9446			
47526	48,00	62,00	10,00	B	NBR	97434		DB	003 997 6147			

Dimensions

Dimensions

dph-no	dim 1	dim 2	dim 3	Style	Material	dph oil seal no.	Application	Type	OEM-NO	Elring	Corteco	Reinz
114489	48,00	62,00	10,00	AW/BS WD	FPM	114440	crankshaft	IVECO	4010 1353		12016835	
35127	48,00	62,00	10,00	B	NBR	18282		MAN	06 56279 0087			
47734	48,00	64,00	12/6	BS WD	NBR	93636	wheel hub	DB	013 997 8847			
93637	48,00	64,00	12/6	BS WD	NBR	93636	wheel hub	DB	019 997 8847	293400	01019283	
113900	48,00	65,00	8,00	SP	NBR	113899	crankshaft	MAZDA	B-216-26-154		19016502	
61330	48,00	65,00	9,00	AW/BS RD	FPM	61331	crankshaft	BMW	11 14 1 275 466	586676	12012045	
84170	48,00	65,00	10,00	AW/BS RD F	FPM	36203	crankshaft	BMW	11 14 1 265 431	022918	12012045	
36212	48,00	65,00	10,00	AW/BS RD F	FPM	36203	crankshaft	BMW	11 14 1 274 346	586676	12012045	81-17404-50
114670	48,00	65,00	10,00	AS W RD	AEM/PTFE	114341	crankshaft	BMW	11 14 2 247 117	050260	20019549	
96713	48,00	65,00	10,00	AS W RD	AEM/PTFE	114341	crankshaft	BMW	11 14 2 249 532	050260	20019549	81-17404-10
109165	48,00	65,00	10,00	B	NBR	81637	gearbox	DAF	0586 697	040991	12011331	
47436	48,00	65,00	10,00	B	NBR	81637	gearbox	DB	000 997 2147	040991		
46994	48,00	65,00	10,00	AS	NBR	19664	crankshaft	DB	004 997 3346			
47615	48,00	65,00	10,00	B	NBR	81637	gearbox	DB	007 997 2147	040991	12011331	
47333	48,00	65,00	10,00	B	NBR	81637	gearbox	DB	009 997 4746	040991		
114605	48,00	65,00	10,00	AW/BS RD	FPM	36203	crankshaft	DB	010 997 4247	586676	01026868	
114669	48,00	65,00	10,00	AS W RD	AEM/PTFE	114341	crankshaft	DB	021 997 1247			
109062	48,00	65,00	10,00	B	NBR	81637	gearbox	FORD	6 109 963		12011331	
110729	48,00	65,00	10,00	B	NBR	81637	gearbox	IVECO	127 4257		12011331	
110731	48,00	65,00	10,00	B	NBR	81637	gearbox	IVECO	298 0071		12011331	
111640	48,00	65,00	10,00	B	NBR	81637	gearbox	IVECO	4248 7485		12011331	
35115	48,00	65,00	10,00	B green	NBR	81637	gearbox	MAN	06 56279 0042	040991	12011331	
34634	48,00	65,00	10,00	B green	NBR	81637	gearbox	MAN	81 96502 0248	040991	12011331	
117340	48,00	65,00	10,00	AS W RD	AEM/PTFE	114341	crankshaft	MAN	81 96502 0934		20016209	
110586	48,00	65,00	10,00	AW/BS RD F	FPM	36203	crankshaft	OPEL	638 269	586676		81-17404-50
93581	48,00	65,00	10,00	A	NBR	18283	crankshaft	PORSCHE	999 113 01250	388904		81-17404-00
114606	48,00	65,00	10,00	B	NBR	81637	gearbox	RENAULT	77 01 014 157	040991	12011331	
114607	48,00	65,00	10,00	B	NBR	81637	gearbox	VOLVO	6 857 279-1	040991	12011331	
108799	48,00	65,00	10,00	B	NBR	81637	gearbox	VOLVO	6 876 127-9	040991	12011331	
114668	48,00	65,00	10,00	AW/BS RD	FPM	36203	crankshaft	VOLVO PC	6 797 454-3		12012045	
84769	48,00	65,00	10,00	B	NBR	81637	gearbox	ZF	0634 300 540			
109257	48,00	65,00	10,00	B	NBR	81637	gearbox	ZF	0734 300 087		12011331	
113767	48,00	65,00	10,00	AW/BS RD	FPM	36203	gearbox	ZF	0750 111 149		20016209	
117341	48,00	65,00	10,00	AS W RD	AEM/PTFE	114341	gearbox	RVI	5000 819 719		20016209	
47289	48,00	65,00	12,00	B	NBR	47290		DB	008 997 1246	460915		

dph-no	dim 1	dim 2	dim 3	Style	Material	dph oil seal no.	Application	Type	OEM-NO	Elring	Corteco	Reinz
47406	48,00	65,00	12,00	B	NBR	47290		DB	011 997 8246	460915		
112362	48,00	65,00	12,70	B LA SP	NBR	112369	wheel hub, front axle	FORD	6 048 486			
117851	48,00	65,00	16,50	SP	FPM	117851	crankshaft	New Holland	85821287		12017310	
115503	48,00	66,65	8,00	AW/BS RD	FPM	98046	crankshaft	SAAB	91 73 576		20026265	
109141	48,00	66,65	10,00	AS RD W	MVQ	37651	crankshaft	ALFA	60524745		12013046	
37650	48,00	66,65	10,00	AS RD W	MVQ	37651	crankshaft	SAAB	93 09 204	330965		81-25789-00
115571	48,00	68,00	9,30	A/BS	NBR	115571	non magnetic oil seal	DB	203 330 0060			
115614	48,00	68,00	9,30	A/BS	NBR	117963	magnetic oil seal	DB	203 330 0060	366230	01032572	
113092	48,00	68,00	10,00	AS RD	ACM	32706	crankshaft	PORSCHE	943 397 01901			
113087	48,00	68,00	10,00	AS WD		113088		PORSCHE	999 113 34740			
32341	48,00	68,00	10,00	AS RD	ACM	32706	crankshaft	VW	025 105 247			
32231	48,00	68,00	10,00	AS RD	ACM	32706	crankshaft	VW	025 105 247 A			
34961	48,00	68,00	10,00	AS RD brown	FPM	34960	crankshaft	VW	026 105 247 A			
111584	48,00	69,00	10,00	B RD	FPM	47988	gearbox	DAF	0693 402		12011306	81-35078-00
47614	48,00	69,00	10,00	B RD	FPM	47988	gearbox	DB	007 997 2047		12011306	81-35078-00
47332	48,00	69,00	10,00	B RD	FPM	47988	gearbox	DB	009 997 4646			
69158	48,00	69,00	10,00	B RD	FPM	47988	gearbox	MAN	81 96502 0226		12011306	
95881	48,00	69,00	10,00	B RD	FPM	47988	gearbox	VOLVO	6 876 126-1		12011306	81-35078-00
82326	48,00	69,00	10,00	B RD	FPM	47988	gearbox	ZF	0734 310 108		12011306	
119237	48,00	70,00	90,00	AS	NBR	43923		Mazda	UH71-26-157			
4067	48,00	72,00	7/9	AS2	NBR	50513	wheel hub	VW	211 501 317	394009	12013894	
50514	48,00	72,00	7/9	AS2	NBR	50513	wheel hub	VW	211 501 317 C			
97944	48,00	72,00	9/8,4	AS2 W	NBR	97944		VW				
84618	48,00	75,00	8,00	B RD	FPM	4545	gearbox	DAF	0110 466	033472	12011307	
114671	48,00	75,00	8,00	B RD	FPM	4545	gearbox	DAF	0609 458	033472	12011307	
47537	48,00	75,00	8,00	B RD	FPM	4545	gearbox	DB	004 997 0747	033472	12011307	
47606	48,00	75,00	8,00	B RD	FPM	4545	gearbox	DB	006 997 8747	033472		
4441	48,00	75,00	8,00	B RD brown	FPM	4545	gearbox	DB	007 997 5447	033472	12011307	
47651	48,00	75,00	8,00	B RD	FPM	4545	gearbox	DB	008 997 3847	033472	12011307	
47374	48,00	75,00	8,00	B RD	FPM	4545	gearbox	DB	010 997 9246	033472		
114672	48,00	75,00	8,00	B RD	FPM	4545	gearbox	MAN	06 56279 0084	033472	12011307	
93757	48,00	75,00	8,00	B RD	FPM	4545	gearbox	MAN	81 96502 0225	033472	12011307	
97374	48,00	75,00	8,00	B RD	FPM	4545	gearbox	ZF	0734 310 110		12011307	
82329	48,00	75,00	8,00	B RD	FPM	4545	gearbox	ZF	0750 111 002		12011307	
93317	48,00	75,00	8/6	B RD	MVQ	93317	gearbox	ZF				

Dimensions

Dimensions

dph-no	dim 1	dim 2	dim 3	Style	Material	dph oil seal no.	Application	Type	OEM-NO	Elring	Corteco	Reinz
46872	48,00	80,00	12/18	BS2	NBR	47964		DB	003 997 0746	109916		
47351	48,00	80,00	12/18	BS2	HNBR	48053		DB	010 997 2246	109916		
114673	48,00	81,00	11,00	SP	PTFE	114343		CUMMINS	3078292			
116809	48,00	73,3/76,50	10,00	B OF SF	NBR	117964	magnetic oil seal	FIAT	4 664 143		01034759	
114674	49,00	62,00	8,00	SP	NBR	113898	wheel bearing	NISSAN	43431-60B20-000			
48725	49,00	62,6/77,50	9/13	BO	NBR	117061	gearbox	FORD	6 562 502			
82177	50,00	58,00	4,00	BO	NBR	22997	stub axle	DB	010 997 4146			
22999	50,00	58,00	4,00	BO	NBR	22997	stub axle	DB	011 997 3546		01012190	
61341	50,00	58,00	4,00	BO	NBR	22997	stub axle	MAN	06 56279 0273			
95833	50,00	58,00	4,00	BO	NBR	22997	stub axle	MAN	06 56279 0353		01012190	
117361	50,00	58,00	4,00	BO	NBR	22997	stub axle	RVI	5010 439 195		01012190	
117362	50,00	58,00	4,00	BO	NBR	22997	stub axle	RVI	5003 087 037		01012190	
114675	50,00	60,00	8,00	BS	NBR	114344	crankshaft	SCANIA	1 324 870		01030356	
96103	50,00	63,00	8,3/13	BS SP	NBR	94652	wheel hub	FORD	1 637 279			
3908	50,00	64,00	10/13,00	B	NBR	37519	rear axle	DB	001 997 4746	411701	12011385	
47375	50,00	65,00	8,00	B	NBR	18316	wheel hub	DB	010 997 9646	041114	01020676	
15267	50,00	65,00	8,00	B	NBR	18316	wheel hub	DB	010 997 9746	041114		
114676	50,00	65,00	8,00	AS W LD	FPM	114345	gearbox	DB	021 997 8047		01030104	
120103	50,00	65,00	8,00	AW/BS RD	FPM	120104		Ferrari	134714			
35092	50,00	65,00	8,00	B	NBR	18316	wheel hub	MAN	06 56271 0807	041114		
80493	50,00	65,00	8,00	B WD	FPM	80492	rear axle	VOLVO	1 522 373	597015	20019176	81-35124-00
48452	50,00	65,00	8,00	A	NBR	97943	wheel hub	VW	211 405 641 D	412104	12010966	
35020	50,00	65,00	10,00	C	NBR	18319	wheel hub	DB	003 997 2546		01003218	
51223	50,00	65,00	10,00	BS	NBR	44507	wheel hub, rear axle	FORD	6 594 477			
117369	50,00	65,00	10,00	B	NBR	116340	wheel hub	MAN	06 56279 0138	041114	01020676	81-35124-00
112360	50,00	65,00	9,75/14	BS SP	NBR	112367	wheel hub	FORD	1 637 281		12011175	
81089	50,00	65,20	10,00	AS W WD	ACM	104440	gearbox	VW	020 301 189 H	527858	12016928	
111232	50,00	65,20	10,00	AS W WD	ACM	104440	gearbox	VW	020 301 189 N	527858	12016928	
104441	50,00	65,20	10,00	AS W WD	ACM	104440	gearbox	VW	020 301 189 T	527858	12016928	
95505	50,00	65,20	6,5/7,5	SP AS W WD	ACM	95508	gearbox	VW	020 301 189 L		01033845	
50,00	67,00	5,5/7,5	special	NBR	113989	wheel bearing	SUBARU	28015-AA011				
47573	50,00	67,50	13,5/8	SP	NBR	48017	engine	DB	005 997 4447	464872	01019452	81-35079-00
114677	50,00	67,50	13,5/8	SP	NBR	48017	engine	DB	005 997 7447		01019452	
47505	50,00	68,00	8,00	A	NBR	18322		DB	002 997 7247			
84539	50,00	68,00	8,00	A	NBR	84538	crankshaft	SCANIA	214 005		12010967	

dph-no	dim 1	dim 2	dim 3	Style	Material	dph oil seal no.	Application	Type	OEM-NO	Elring	Corteco	Reinz
120456	50,00	68,00	8,50	A SP	NBR	81051	wheel hub	Toyota	903115005		19017041	
95604	50,00	68,00	9,00	AS RD FILZ	FPM	95621	crankshaft	OPEL	614 835		19033958	
114678	50,00	68,00	10,00	A/B W RD	FPM	82470	crankshaft	PEUGEOT	0127 11	508470	12013865	81-16737-20
94472	50,00	68,00	10,00	AS W RD	FPM	82470	crankshaft	RENAULT	77 00 619 463			
82471	50,00	68,00	10,00	A/B W RD	FPM	82470	crankshaft	RENAULT	77 00 719 274	508470	12013865	81-16737-20
82472	50,00	68,00	10,00	A/B W RD	FPM	82470	crankshaft	RENAULT	77 00 866 877	508470	12013865	81-16737-20
82970	50,00	68,00	10,00	A/B W RD	FPM	82470	crankshaft	RENAULT	77 01 349 140		12013865	
82481	50,00	68,00	10,00	A/BS W RD	FPM	82470	crankshaft	VOLVO	8 414 241-3		12013865	81-16737-20
47449	50,00	68,00	14,00	B	NBR	18327		DB	000 997 5647			
47456	50,00	68,00	14,00	B	NBR	18327		DB	000 997 8847			
97898	50,00	68,00	11,5/8,2	SP	FPM	97897	differential	OPEL	354 197			
97873	50,00	68,00	7/10,5	SP	FPM	97872	crankshaft	OPEL	614 800		19033966	
15269	50,00	68,40	10/14,3	BS SP blue	NBR	116341	wheel hub	DB	008 997 9646	008028		
34017	50,00	70,00	8,00	C blue	NBR	61496	front axle	DB	006 997 9046	108642		
34018	50,00	70,00	8,00	C blue	NBR	61496	front axle	DB	008 997 9746	108642	01020675	
80537	50,00	70,00	8,00	C	NBR	61496	front axle	MAN	06 56279 0029	108642	01020675	
114679	50,00	70,00	9,00	A/B WD	FPM	112583	crankshaft	DEUTZ	432 2445		01019463	
112584	50,00	70,00	9,00	A/B WD	FPM	112583	crankshaft	SCANIA	1 104 500		01019463	
70451	50,00	70,00	10,00	A	NBR	18328	crankshaft	SCANIA	14 107		12010969	
114680	50,00	70,00	10,00	C	FPM	114347	crankshaft	ZF	0634 310 209		01029755	
35200	50,00	70,00	12,00	C	NBR	18333	crankshaft	MAN	81 35925 0007			
15268	50,00	70,00	10/14	BS2 blue	NBR	59295	front axle	DB	006 997 9646	008028	01016768	81-35292-00
69796	50,00	70,00	10/14	BS2	NBR	59295	front axle	MAN	06 56279 0031	008028	01016768	
112453	50,00	70,00	10/14	BS2	NBR	59295	front axle	MAN	06 56279 0080	008028		
47329	50,00	70,00	13,5/8	BS SP	NBR	37350	front axle	DB	009 997 3346	009075	12012696	
47686	50,00	70,00	13,5/8	BS SP	NBR	37350	front axle	DB	010 997 6547	009075	12012696	
47687	50,00	70,00	13,5/8	BS SP	NBR	37350	front axle	DB	010 997 6647	009075	12012696	
37351	50,00	70,00	13,5/8	BS SP	NBR	37350	front axle	DB	010 997 6747	009075	12012696	
47396	50,00	70,00	13,5/8	BS SP	NBR	37350	front axle	DB	011 997 5146	009075		
47712	50,00	70,00	13,5/8	BS SP	NBR	37350	front axle	DB	011 997 5547	009075	12012696	
4071	50,00	70,00	13,5/8	BS SP	NBR	37350	front axle	DB	011 997 6046	009075	12012696	
84203	50,00	70,00	13,5/8	BS SP	NBR	37350	front axle	DB	019 997 0847	009075		
47437	50,00	72,00	10,00	A	NBR	18335	crankshaft	DB	000 997 2247	418501	12010971	
47034	50,00	72,00	10,00	A	NBR	18335	crankshaft	DB	005 997 8546	418501	12010971	
119219	50,00	72,00	10,00	DGS WD	NBR	119219						

Dimensions

Dimensions

dph-no	dim 1	dim 2	dim 3	Style	Material	dph oil seal no.	Application	Type	OEM-NO	Elring	Corteco	Reinz
46875	50,00	72,00	12,00	B	NBR	18339		DB	000 997 3246			
46972	50,00	72,00	8/10	AS V	NBR	47950	steering	DB	003 997 7246	006432		
69287	50,00	72,00	8/10	AS V	NBR	47950	steering	VOLVO PC	346 381-7	006432		
96108	50,00	72,00	8/10	AS V	NBR	47950	steering	ZF	0770 198 037			
111378	50,00	76,00	9/15,5	AS SP	NBR	111378						
82218	50,00	80,00	10,00	C	NBR	18347		DB	011 997 6646			
113625	50,00	80,00	10/16	BS LA SP	ACM	113624		DB	002 997 0547			
119098	50,00	81,00	13,00	BS	ACM	81345	differential	IVECO	4000 3710		12011432	
83899	50,00	81,00	13,00	BS	ACM	81345	differential	IVECO	4000 3713		12011432	
114053	50,00	90,00	14,00	SP	PTFE	114097	crankshaft	FORD	1 230 867	026780		81-90014-00
113930	50,00	100,00	7,50	SP	ACM	113929	crankshaft	ZF	0734 307 287			
114682	50,80	65,00	8,00	B WD	FPM	114348	crankshaft	MAN	81 32050 0219		12012592	
47021	50,80	65,00	9/9,50	AS	NBR	48040	steering	DB	005 997 4246	237752		
47404	50,80	65,00	9/9,50	AS	NBR	48040	steering	DB	011 997 7946	237752	01026321	
22998	51,00	58,00	4,00	BO	NBR	22996	stub axle	DB	006 997 7147	222940		
82522	51,00	65,00	9,00	BS	NBR	82522						
119808	51,90	66,00	8/10	BS 2 SP	NBR	119811		Mitsubishi	808444			
97086	52,00	65,00	9,00	BS RD	ACM	97083		Mitsubishi	MH034220			
94352	52,00	65,00	9/6	A/BS SO blue	NBR	94351	crankshaft	DB	014 997 7047		01019318	
113094	52,00	68,00	8,00	AS LD SP	FPM	70208		BMW	24 13 7 509 504			
97431	52,00	68,00	8,00	A/BS RD	FPM	96995	gearbox	DB	015 997 0647	141960	12018806	
97423	52,00	68,00	8,00	A/BS RD	FPM	96995		DB	015 997 1647	141960	12018806	
117342	52,00	68,00	8,00	A/BS RD	FPM	96995	gearbox	MAN	81 96502 0403	141960	01029746	
97234	52,00	68,00	8,00	A	NBR	19706		PORSCHE	999 113 08540			
112950	52,00	68,00	8,00	A/BS RD	FPM	96995	crankshaft	ZF	0734 310 104		12018806	
4480	52,00	68,00	10,00	AS RD W	MVQ	16052	crankshaft	VOLVO	1 276 425	465194	15012624	
33553	52,00	68,00	10,00	AS RD W	MVQ	16052	crankshaft	VOLVO PC	1 276 424	465194	15012624	81-25587-00
114683	52,00	68,00	10,00	AS RD W	MVQ	16052	crankshaft	VOLVO PC	430 132		15012624	
47501	52,00	70,00	10,00	B	FPM	47502		DB	002 997 6647			
114684	52,00	72,00	8,00	A W	FPM	114349	crankshaft	DB	010 997 7246		01012588	
80689	52,00	72,00	10,00	A LD	MVQ	80688		BMW	11 11 0 001 122			
114685	52,00	72,00	10,00	B	FPM	114350	crankshaft	MAN	81 96501 0798		01030105	
80988	52,00	72,00	10,00	AS RD	ACM	80987	crankshaft	OPEL	406 748			
47450	52,00	72,00	12,00	BS WD	FPM	47951	gearbox	DB	000 997 6647	006564	01002858	
47470	52,00	72,00	12,00	BS WD	FPM	47951	gearbox	DB	001 997 3247	006564		

dph-no	dim 1	dim 2	dim 3	Style	Material	dph oil seal no.	Application	Type	OEM-NO	Elring	Corteco	Reinz
47472	52,00	72,00	12,00	BS WD	FPM	47951	gearbox	DB	001 997 5047	006564		
46954	52,00	72,00	12,00	C	NBR	18376	wheel hub	DB	003 997 1446		01003238	
46974	52,00	72,00	12,00	BS WD	FPM	47951	gearbox	DB	003 997 7546	006564	01016879	
47288	52,00	72,00	12,00	BS	NBR	35095	gearbox	DB	008 997 0546	091901		
47665	52,00	72,00	12,00	BS WD	FPM	47951	differential	DB	009 997 6347	006564		
47718	52,00	72,00	12,00	BS WD	FPM	47951	gearbox	DB	011 997 7447	006564	01016879	
47726	52,00	72,00	12,00	BS WD	FPM	47951	gearbox	DB	012 997 2947	006564	01016879	
35094	52,00	72,00	12,00	BS	NBR	35095	differential	MAN	06 56272 0047	091901		
35116	52,00	72,00	12,00	BS	NBR	35095	differential	MAN	06 56279 0047	091901		
113906	52,00	75,00	14,70	BS	NBR	113905	crankshaft	PEUGEOT	3724 30		12013760	
114686	52,00	87,00	10/18	AS W WD SP	ACM	114351	crankshaft	MAN	81 96502 0216		01029920	
114687	52,00	97,00	10/18	AS W WD SP	FPM	114353		MAN	81 96502 0676		01020680	
113940	53,00	68,00	10,00	A	NBR	18390	crankshaft	RVI	5000 350 272		12010980	
94339	53,00	71,00	11,50	BS WD	NBR	94338	rear axle	DB	017 997 3947	151920	01018030	
115942	53,00	73,00	10,00	A/BS WD	NBR	117962	magnetic oil seal	DB	025 997 1647		01033874	
116320	53,00	73,00	10,00	A/BS WD	NBR	116320	non magnetic oil seal	DB	025 997 1647			
113970	53,00	97,00	8,00	A W WD	NBR	113969	wheel hub	RVI	5000 546 916		07016775	
47030	53,98	76,20	12,5/8	C	NBR	48042	wheel hub	DB	005 997 7046		01003247	
119807	54,00	76,00	8/11	BS 2 SP	NBR	119810		Mitsubishi	808443			
50178	54,00	82,00	11,45	AS LD	ACM	4235	crankshaft	OPEL	614 814	231665	12010693	81-21343-00
4236	54,00	82,00	11,45	AS LD	ACM	4235	crankshaft	OPEL	614 818	231665	12010693	81-21343-00
59234	54,00	82,00	11,45	AS LD	ACM	4235	crankshaft	OPEL	614 831	231665		81-21343-00
109531	54,10	70/74	7,5/11	BA OF	NBR	111355	crankshaft	SCANIA	1 100 645		12013506	
114688	54,15	35,00	9,50	SP	PTFE	114354		CATERPIL	8C3100			
114689	54,50	80,00	8,00	BS WD	FPM	114355	crankshaft	VOLVO	1 526 008		01030336	
48722	54,51	76,09	9,5/15,4	AS RD SF	NBR	97926	wheel hub	FORD	6 142 760		12012570	
95383	54,76	76,20	13,10	BS SP	MVQ	95383						
47405	54,80	70,00	9/7,00	AS SP	NBR	36703	steering	DB	011 997 8046	237760		
46864	54,80	70,00	9/9,60	AS	NBR	47963		DB	002 997 7746	237760		
47026	54,80	70,00	9/9,60	AS	NBR	47963		DB	005 997 5546	237760		
114690	55,00	62,00	4,00	BO	NBR	114356	stub axle	DB	015 997 3747		01026865	
114691	55,00	68,00	8,00	AS/B	ACM	37352	crankshaft	DB	008 997 0647		12014730	
37038	55,00	68,00	8,00	AS/B	ACM	37352	crankshaft	DB	008 997 6147		12014730	
37037	55,00	68,00	8,00	AS/B	ACM	37352	crankshaft	DB	014 997 6747		12014730	
97818	55,00	68,00	8,00	A/BS WD	FPM	97817	crankshaft	DB	020 997 5347		01030522	

Dimensions

Dimensions

dph-no	dim 1	dim 2	dim 3	Style	Material	dph oil seal no.	Application	Type	OEM-NO	Elring	Corteco	Reinz
120105	55,00	68,00	8,00	AW/BS LD	FPM	120106		Ferrari	187140			
114692	55,00	68,00	8,00	A/BS RD	FPM	97403	camshaft	MAN	06 56279 0352		12015711	
116664	55,00	68,00	8,00	AW/BS RD	PTFE/AEM	115399	crankshaft	Opel	5 638 605		20030111	81-36228-00
97397	55,00	68,00	8,00	A/BS RD	FPM	97403		OPEL	638 196	477010	12015711	81-34158-00
4144	55,00	68,00	8,50	AS W	NBR	36319	front axle	VW	251 407 641 A	284459	12013929	
36327	55,00	68,00	8,50	AS W	NBR	36319	front axle	VW	251 407 641 B			
4072	55,00	68,00	8,50	AS W	NBR	36319	front axle	VW	251 407 641 C			
48162	55,00	68,00	8,50	AS W	NBR	36319	front axle	VW	281 407 641 C	284459	12013929	
114693	55,00	68,00	12,00	B Duo	NBR	93695	crankshaft	IVECO	247 8478		12011383	
109142	55,00	70,00	8,00	AS	NBR	50342	wheel hub	ALFA	60709430		12011182	
47425	55,00	70,00	8,00	BS	NBR	44378		DB	608 997 0846			
47428	55,00	70,00	8,00	A	NBR	18407	wheel hub	DB	608 997 1346	440302	12010981	
111776	55,00	70,00	8,00	A/BS RD SF	FPM	111775	crankshaft	FIAT	4010 0330		12015120	
114694	55,00	70,00	8,00	AS W RD	PTFE/AEM	114357	crankshaft	MAN	51 96501 0535		20031171	
111778	55,00	70,00	10,00	A/BS RD SF	FPM	111777	injection pump	FIAT	4010 0320		12015093	
81735	55,00	70,00	12,00	A W	MVQ	81299	crankshaft	STEYR	90 003 074 340			
4073	55,00	70,00	6/10,25	BS SP	NBR	112368	rear axle	FORD	6 043 882	587036	12011181	
112361	55,00	70,00	6/10,5	BS SP	NBR	112368	wheel hub	FORD	1 637 280	587036	12011181	
81065	55,00	70,10	5,50	AW/B LD	FPM	51306	camshaft	OPEL	636 839	694711		81-27317-00
51309	55,00	70,10	5,50	AW/B LD	MVQ	51309	camshaft	OPEL	636 839			
50706	55,00	70,10	5,50	AW/B LD	FPM	51306	camshaft	OPEL	638 194	694711		81-27317-00
51309	55,00	70,10	5,50	AW/B LD	MVQ	51309	engine	OPEL	638 194			
93722	55,00	72,00	10,00	AW/BS RD	FPM	93721	crankshaft	BMW	11 14 1 713 722	818364	20020462	
116111	55,00	72,00	10,00	AW/BS RD	FPM	93721	crankshaft	BMW	11 14 1 725 994	818364	20020462	
82223	55,00	72,00	10,00	BS	NBR	45537		DB	003 997 9147			
93755	55,00	72,00	10,00	C	NBR	18418	differential	DB	006 997 1246		01001557	
114695	55,00	72,00	10,00	BS	NBR	45537		MAN	06 56279 0049			
81186	55,00	73,00	8,50	BA OF	NBR	81186	steering	ZF				
114696	55,00	73,00	13,00	SP	PTFE	114358		CUMMINS	3016788			
46985	55,00	75,00	8,00	B RD	FPM	36792	gearbox	DB	004 997 0846			
95340	55,00	75,00	8,00	B RD	FPM	36792	gearbox	DB	004 997 6946		12011308	
47554	55,00	75,00	8,00	BS	NBR	47555		DB	004 997 7147			
47562	55,00	75,00	8,00	BS	NBR	47555		DB	005 997 0247			
47569	55,00	75,00	8,00	BS	NBR	47555		DB	005 997 2547			
36793	55,00	75,00	8,00	B RD	FPM	36792	gearbox	DB	007 997 2247	284645	12011308	

dph-no	dim 1	dim 2	dim 3	Style	Material	dph oil seal no.	Application	Type	OEM-NO	Elring	Corteco	Reinz
47305	55,00	75,00	8,00	B RD	FPM	36792	gearbox	DB	008 997 7246	284645		
93804	55,00	75,00	8,00	B RD	FPM	36792	gearbox	MAN	81 96502 0761	284645	12011308	
95878	55,00	75,00	8,00	B RD	FPM	36792	crankshaft	VOLVO	1 526 688			81-35152-00
95877	55,00	75,00	8,00	B RD	FPM	36792	gearbox	ZF	0734 310 111		12011308	
113768	55,00	75,00	8,00	B RD	FPM	36792	gearbox	ZF	0734 310 386		12011308	
116558	55,00	75,00	8,00	B RD	FPM	36792	gearbox	ZF	0734 310 387			
96716	55,00	75,00	9,00	BS RD	FPM	96717	gearbox	SCANIA	1 318 388		12015253	
114697	55,00	75,00	9,00	BS RD	FPM	96717	crankshaft	SCANIA	378 620		12015253	
46890	55,00	75,00	10,00	AS	NBR	6547	engine	DB	000 997 6646			
4645	55,00	75,00	10,00	AS blue	NBR	6547	engine	DB	003 997 3047			
109583	55,00	75,00	10,00	A/BS RD	ACM	109582	crankshaft	DEUTZ	417 5434	746300	01032068	81-20991-00
46986	55,00	75,00	10/8	B	NBR	50345	gearbox	DB	004 997 0946	041335	12011333	81-20991-20
61442	55,00	75,00	10/8	B	NBR	50345	gearbox	DB	007 997 2347			81-20991-20
81541	55,00	75,00	10/8	BS	MVQ	81541		DB				
109256	55,00	75,00	10/8	B	NBR	50345	gearbox	ZF	0734 300 094		12011333	
47559	55,00	75,00	9/11	AS	NBR	47977		DB	004 997 9247	522287		
47590	55,00	75,00	9/11	AS	NBR	47977	crankshaft	DB	006 997 0747			
114698	55,00	80,00	8,00	A/BS RD	FPM	114359	gearbox	DB	021 997 1747	456970	01030099	
114699	55,00	80,00	8,00	A/BS RD	FPM	114359	gearbox	DB	021 997 2547	456970	01030099	
119846	55,00	80,00	8,00	AS	NBR	42903	crankshaft	PEUGEOT	3723.06		120109858	
96854	55,00	80,00	10,00	BS	NBR	50343	gearbox	DB	004 997 6646	446602		
83893	55,00	80,00	10,00	BS	NBR	50343	gearbox	IVECO	4000 0520			
112543	55,00	80,00	10,00	BS	NBR	50343	gearbox	IVECO	4248 6609			
117329	55,00	80,00	10,00	BS	NBR	50343	gearbox	MAN	06 56279 0136	446602		
35209	55,00	80,00	10,00	A	NBR	18431	transmission	MAN	81 96501 0445	446602		
46911	55,00	80,00	13,00	BS	NBR	19125		DB	001 997 8446			
47756	55,00	80,00	13,00	BS	NBR	19125		DB	304 997 1547			
35117	55,00	80,00	13,00	B	NBR	18440		MAN	06 56279 0050			
47011	55,00	80,00	10/12	AS	NBR	80530	crankshaft	DB	005 997 0946	048437	12010986	
114700	55,00	80,00	10/12	AS	NBR	80530	crankshaft	MAN	06 56279 0194			
114701	55,00	81,00	11,00	SP	PTFE	114360		CUMMINS	3020187			
109532	56,00	70,00	6,00	A SP	NBR	109212		SCANIA	347 468			
98688	56,00	70,00	9,00	A	NBR	98689	crankshaft	DB	014 997 6447		01026320	
96503	56,00	70,00	9/6	AS SP	NBR	80858	steering	DB	004 997 5847			
96495	56,00	70,00	9/6	AS SP	NBR	80858	steering	DB	011 997 0346	235350		

Dimensions

Dimensions

dph-no	dim 1	dim 2	dim 3	Style	Material	dph oil seal no.	Application	Type	OEM-NO	Etring	Corteco	Reinz
80859	56,00	70,00	9/6	AS SP	NBR	80858	steering	DB	016 997 1647			
119277	56,00	72,00	7,00	A SP	NBR	109213	steering	SCANIA	1 357 268			
119278	56,00	72,00	7,00	A SP	NBR	109213	crankshaft	SCANIA	1 379 477			
109529	56,00	72,00	7,00	A SP	NBR	109213	steering	SCANIA	1 395 999			
111752	56,00	72,00	8,00	A/BS RD	FPM	111751		DB	019 997 0547	220900	12019647	
112762	56,00	72,00	8,00	A/BS RD	FPM	111751	transfer gearbox	DB	019 997 0647	220900	12019647	
114032	56,00	72,20	8/10	SP	NBR	114031	wheel bearing	SUZUKI	09283-56002			
114702	56,00	72,30	8/12	SP	NBR	114033	wheel bearing	SUBARU	28015-AA021			
118818	56,00	72,50	9,5/13,50	BS2 SP	NBR	118818						
114703	57,00	67,50	6,50	SP	PTFE	114361		CUMMINS	3627961			
111532	57,00	71,00	7/6,5	AS WD	ACM	111531	differential	VW	084 409 189 C		12015557	
111754	57,00	74,00	12,50	B OF SF	FPM	111753	crankshaft	RVI	5000 790 853		07016381	
47349	57,00	75,00	7,5/6	AS K	NBR	48052	front axle	DB	010 997 1746	008664	01020674	
82931	57,00	75,00	7,5/6	AS K	NBR	48052	front axle	MAN	06 56279 0025	008664	01020674	
118191	57,15	74,60	8,73/9,52		HNBR	118191						
95383	57,15	76,20	12,70	BS SP	MVQ	95383	crankshaft	PERKINS				
97905	57,15	81,86	7/14	AS SF	NBR	97904	wheel hub	FORD	6 143 628		12017122	
47836	58,00	72,00	8,00	A W	NBR	113615	crankshaft	DB	00650 405 8200		12010993	
32871	58,00	75,00	12,00	C blue	NBR	50807	gearbox	DB	008 997 1146	043932	01003273	
35096	58,00	80,00	10,00	C	NBR	18474		MAN	06 56272 1212			
113937	58,00	80,00	10,00	A	NBR	18473	wheel hub	RVI	5516 015 596		12010995	
115591	58,00	80,00	10/8	AW/BS blue	NBR	115590	differential	DB	007 997 0347			
47031	59,00	72,00	12/12,50	AW/BS	NBR	15259	transmission shaft	DB	005 997 7146	467871	12012242	81-35081-00
37518	59,00	72,00	12/12,50	AW/BS	NBR	15259	transmission shaft	DB	005 997 7846		12012242	
3909	59,00	72,00	12/12,50	AW/BS	NBR	15259	transmission shaft	DB	007 997 3547	467871	12012242	81-35081-00
97896	59,00	75,00	9/11,5	SP	NBR	97895	wheel hub	OPEL	328 411			
47325	60,00	65,00	10/8	A	NBR	48049	crankshaft	DB	009 997 1646		12011000	
115679	60,00	73,00	11/7	AW/BS WD	FPM	115992	wheel hub	VW	2D0 501 317 A		01016963	
35178	60,00	74,00	10,00	B	NBR	35179	crankshaft	ZF	0734 300 002			
114704	60,00	74,00	10/8	AS W LD	FPM	113749	gearbox	DAF	0585 910		12013365	
114705	60,00	74,00	10/8	AS W LD	FPM	113749	gearbox	MAN	81 96501 0410		12013365	
114706	60,00	74,00	10/8	AS W LD	FPM	113749	gearbox	VOLVO	346 682-8		12013365	
114707	60,00	74,00	10/8	AS W LD	FPM	113749	gearbox	VOLVO	6 770 964-2		12013365	
114708	60,00	74,00	10/8	AS W LD	FPM	113749	gearbox	ZF	0734 300 024		12013365	
113752	60,00	74,00	10/8	AS W LD	FPM	113749	gearbox	ZF	0734 319 688			

dph-no	dim 1	dim 2	dim 3	Style	Material	dph oil seal no.	Application	Type	OEM-NO	Etring	Corteco	Reinz
113753	60,00	74,00	10/8	AS W LD	FPM	113749	gearbox	ZF	0750 111 469			
117398	60,00	75,00	8,00	A	NBR	18484	crankshaft	IVECO	4459 074		12010997	
119411	60,00	75,00	10,00	AS W RD	PTFE/ACM	119418	water pump shaft	RENAULT	50 10 550 614		20031971	
115542	60,00	78,00	7,50	SP	MVQ	115542		Mitsubishi	MD016317			
82867	60,00	78,00	10,00	A RD	FPM	82867						
114709	60,00	80,00	7,00	A W	FPM	114362	gearbox	DB	020 997 1247		12019243	
47504	60,00	80,00	8,00	A	NBR	18489	crankshaft	DB	002 997 7147	029335		
47645	60,00	80,00	10,00	C	NBR	51483	rear axle	DB	008 997 2947	041513		
47745	60,00	80,00	10,00	A	NBR	81629	crankshaft	DB	303 997 0947	041491	12010999	
84559	60,00	80,00	10,00	A	NBR	81629	crankshaft	DEUTZ	116 3205			81-17085-00
35097	60,00	80,00	10,00	C green	NBR	51483	front axle	MAN	06 56272 1312	041513		
35119	60,00	80,00	10,00	BS	NBR	35120		MAN	06 56279 0055			
104429	60,00	80,00	10,00	CS	NBR	104422		MAN	06 56279 0235			
93582	60,00	80,00	10,00	A	NBR	81629	crankshaft	PORSCHE	999 113 02950	041491		81-17085-00
34918	60,00	80,00	10,00	A blue	NBR	81629	crankshaft	VW	111 105 245	041491		
46913	60,00	80,00	13,00	B	NBR	18499		DB	001 997 9046			
35118	60,00	80,00	13,00	B	NBR	18499		MAN	06 56279 0054			
95152	60,00	80,00	11/13	AS W RD	ACM	95543	crankshaft	STEYR	90 003 074 347			
95151	60,00	80,00	11/13	AS W LD	ACM	95926	crankshaft	STEYR	90 003 074 348			
114710	60,00	80,00	8/19	SP	FPM	114363	gearbox	DB	020 997 1347		12019242	
70270	60,00	80,00	8/9,5	BS RD	FPM	81817	gearbox	VOLVO	267 316		12013864	
47465	60,00	85,00	10,00	B	NBR	47466		DB	001 997 1547			
82211	60,00	85,00	10,00	B	NBR	47466	differential	DB	002 997 7646	041599	12011334	
47622	60,00	85,00	10,00	B	NBR	47466	gearbox	DB	007 997 5547		12011334	
47752	60,00	85,00	10,00	AS green	NBR	82395		DB	304 997 0947		12011000	
112548	60,00	85,00	10,00	B	NBR	47466	gearbox	IVECO	4000 2020		12011334	
35098	60,00	85,00	10,00	B	NBR	47466	gearbox	MAN	06 56272 1313		12011334	
80592	60,00	85,00	10,00	A RD	FPM	80591	crankshaft	PORSCHE	999 113 26340	557846		81-21108-20
94631	60,00	85,00	10,00	B	NBR	47466	gearbox	ZF	0734 300 100		12011334	
47464	60,00	85,00	12,00	B RD	FPM	47991	steering	DB	001 997 1447			
47623	60,00	85,00	12,00	B RD	FPM	47991	gearbox	DB	007 997 5647		12012578	81-21108-20
114711	60,00	85,00	12,00	B RD	FPM	47991	gearbox	IVECO	4248 7132		12012578	
114712	60,00	85,00	12,00	B RD	FPM	47991	gearbox	RENAULT	50 00 803 236		12012578	
94632	60,00	85,00	12,00	B RD	FPM	47991	gearbox	ZF	0734 310 122		12012578	
47746	60,00	90,00	10,00	A	NBR	18510	crankshaft	DB	303 997 1047	479004	12011002	

Dimensions

Dimensions

dph-no	dim 1	dim 2	dim 3	Style	Material	dph oil seal no.	Application	Type	OEM-NO	Elring	Corteco	Reinz
83901	60,00	90,00	14/16,30	SP	FPM/ACM	81354	differential	IVECO	4010 2263		12015791	
119106	60,00	90,00	14/16,30	SP	FPM/ACM	81354	differential	IVECO	4010 2660		12015791	
47358	60,00	95,00	8/10	AS	NBR	48054		DB	010 997 3446			
47359	60,00	95,00	8/10	AS	NBR	48054		DB	010 997 3546			
82506	60,32	79,37	9,52	AS RD	FPM	82504	crankshaft	PERKINS	2418 F 436		12014981	
37643	60,35	76,18	11,00	AW/BS LD	MVQ	37642	crankshaft	FORD	1 634 647			
95623	60,35	76,18	11,00	AW/BS LD	FPM	95623	crankshaft	FORD	1 634 647			
111394	60,40	80,00	12,00	BS RD SP	FPM	109799	crankshaft	MAN	51 01510 0152	323780	12015383	81-24895-00
96911	60,45	76,18	10,00	AS LD W	FPM	95897	crankshaft	FORD	1 048 572	693201		81-20286-00
95898	60,45	76,18	10,00	AS LD W	FPM	95897	crankshaft	FORD	6 803 967	693201	12015546	81-20286-00
3905	60,50	78,00	9,00	A RD	MVQ	3904	crankshaft	PEUGEOT	2109 22		46083011	
35121	62,00	75,00	10,00	B	NBR	35122	rear axle	MAN	06 56279 0057			
114713	62,00	78,00	10,00	AW/BS LD	FPM	114364	gearbox	DB	014 997 0147		01016882	
114714	62,00	78,00	10,00	AW/BS LD	FPM	114364	gearbox	DB	016 997 3047		01016882	
48720	62,00	78,00	9/15	BS SP	NBR	48719		FORD	6 612 972			
47479	62,00	80,00	10,00	C	NBR	51708	front axle	DB	001 997 7747	484300	12003292	
47524	62,00	80,00	10,00	B	NBR	18528	crankshaft	DB	003 997 5947	028436		
47049	62,00	80,00	10,00	C	NBR	51708	front axle	DB	006 997 2646	484300	12003292	
113953	62,00	80,00	10,00	A/BS W blue	NBR	113952	transmission shaft	DB	015 997 0147	801230	12015885	
119097	62,00	80,00	10,00	BS LD	ACM	81351	crankshaft	IVECO	4000 0280		12011433	
83894	62,00	80,00	10,00	BS LD	ACM	81351	crankshaft	IVECO	4000 0283	028436	12011433	
96080	62,00	80,00	10,00	C	NBR	51708	front axle	MAN	06 56279 0147	484300	12003292	
96079	62,00	80,00	10,00	B	FPM	32721		MAN	06 56279 0148			
97931	62,00	80,00	12,00	BS RD LA	FPM	97930		FORD	6 135 100	562629	12011475	81-23418-10
94055	62,00	80,00	12/11	AS W LD	MVQ	82138	crankshaft	DEUTZ	223 4498	352136	01034681	
35123	62,00	85,00	10,00	C	NBR	18534		MAN	06 56279 0059			
114715	62,00	80/86	9/14	KA	NBR	114365	wheel hub	DB	905 997 0246	453910	01029698	
114716	63,50	79,50	8,00	SP	PTFE	114366		CUMMINS	3900709			
114717	63,50	102,50	6,6/14,8	AS W WD SF	FPM	114367	crankshaft	DAF	0691 048		01030337	
114718	63,50	102,50	6,6/14,8	AS W WD SF	FPM	114367	crankshaft	VOLVO	6 877 944-6		01030337	
69289	63,50	110,00	12,00	BS LD F	FPM	69288		VOLVO	943 250-1			
97151	64,00	80,00	8,00	B RD	ACM	94587	crankshaft	FIAT	4000 0460		12011436	
116131	64,00	80,00	8,00	A/BS LD	MVQ	95377	crankshaft	FIAT	4000 4350			81-35876-00
36425	64,00	80,00	13,00	AS blue	NBR	61497	front axle	DB	009 997 6647	008591		
36426	64,00	80,00	13,00	AS blue	NBR	61497	front axle	DB	009 997 7546	008591		

dph-no	dim 1	dim 2	dim 3	Style	Material	dph oil seal no.	Application	Type	OEM-NO	Elring	Corteco	Reinz
47668	64,00	80,00	13,00	AS blue	NBR	61497	front axle	DB	009 997 7547	008591		
47364	64,00	80,00	13,00	AS blue	NBR	61497	front axle	DB	010 997 5546	008591		
69190	64,00	80,00	13,00	AS blue	NBR	61497	front axle	MAN	06 56279 0181	008591	01016769	
114719	64,00	80,00	11,5/16	AS W	NBR	114368	stub axle	DB	022 997 0047		01026493	
93634	64,50	85,00	10,00	A LD	MVQ	93633		PORSCHE	901 102 91100			
35804	64,90	90,00	10,00	BS RD LA F	FPM	35885		VOLVO	267 268	587958	12013360	
114720	64,90	90,00	9,5/10	A/B RD felt	FPM	112981	gearbox	VOLVO	1 521 431	435820	01030098	
112980	64,90	90,00	9,5/10	A/B RD felt	FPM	112981	gearbox	VOLVO	20 476 025		01030098	
115397	65,00	79,00	20,00	AS RD	PTFE/AEM	115400	crankshaft	BMW	11 11 7 511 395	257400	20033890	81-34057-00
93698	65,00	80,00	8,00	BS	NBR	43194		IVECO	4206 1445			
94036	65,00	80,00	8,00	B RD LA	FPM	119374	crankshaft	VOLVO	948 826-3		01026644	
46987	65,00	80,00	8/5,20	B	FPM	47954		DB	004 997 1246	493902		
47268	65,00	80,00	8/5,20	B	FPM	47954	crankshaft	DB	007 997 7946	493902	20020508	
47473	65,00	85,00	10,00	B	FPM	47474		DB	001 997 6447			
47475	65,00	85,00	10,00	B	FPM	47474		DB	001 997 6647		01019455	
47476	65,00	85,00	10,00	B	FPM	47474		DB	001 997 6847			
47478	65,00	85,00	10,00	A	NBR	18565	crankshaft	DB	001 997 7547	494402		
47519	65,00	85,00	10,00	A	NBR	18565	crankshaft	DB	003 997 3347	494402	12011007	
47529	65,00	85,00	10,00	A	NBR	18565	crankshaft	DB	003 997 6947	494402	12011007	
47704	65,00	85,00	10,00	AS	NBR	18566	crankshaft	DB	011 997 1247		12011195	
82860	65,00	85,00	10,00	B	NBR	18567		MAN	06 56271 1613			
82461	65,00	85,00	10,00	A W LD	MVQ	82464	crankshaft	PORSCHE	999 113 05750	494500		81-15332-20
111534	65,00	85,00	10,00	AS2 WD	NBR	111533	wheel hub	VW	291 501 317	046094	12013927	
82332	65,00	85,00	10,50	special	FPM	80375	crankshaft	DEUTZ	415 4144		01029745	
35099	65,00	85,00	12,00	C	NBR	18571		MAN	06 56272 1613			
114721	65,00	85,00	13,00	AW/BS LD	FPM	114374	gearbox	VOLVO	6 797 452-7		12014424	
114722	65,00	85,00	15,50	A/BS WD	FPM	114369	transfer gearbox	DB	011 997 4447	451120	01029680	
114723	65,00	85,00	15,50	A/BS WD	FPM	114369	transfer gearbox	DB	016 997 4947		01029680	
81566	65,00	85,00	13/12,5	BS RD LA SP	FPM	93422	crankshaft	DEUTZ	223 4133		12012095	
81014	65,00	85,00	13/12,5	BS RD LA SP	FPM	93422	crankshaft	DEUTZ	415 0782	033457	12012095	81-21527-20
94264	65,00	85,00	13/12,5	BS RD LA SP	FPM	93422	crankshaft	DEUTZ	415 2348	033457		
114496	65,00	85,00	9,5/10	A WD F	NBR	113534	wheel hub	RVI	5010 216 174		01029810	
111669	65,00	90,00	10,00	BS WD	FPM	111748	crankshaft	DAF	0299 521		01029683	
46850	65,00	90,00	10,00	A	NBR	18573		DB	000 997 0746			
47494	65,00	90,00	10,00	AS WD	NBR	48006	crankshaft	DB	002 997 3947			

Dimensions

Dimensions

dph-no	dim 1	dim 2	dim 3	Style	Material	dph oil seal no.	Application	Type	OEM-NO	Eling	Corteco	Reinz
47495	65,00	90,00	10,00	AS WD	NBR	48006	crankshaft	DB	002 997 4047			
47496	65,00	90,00	10,00	AS WD	NBR	48006	crankshaft	DB	002 997 4147		12011196	
47497	65,00	90,00	10,00	AS WD	NBR	48006	crankshaft	DB	002 997 4247			
47667	65,00	90,00	10,00	C	FPM	48036	crankshaft	DB	009 997 7047		01029759	
114724	65,00	90,00	10,00	AS W WD	FPM	114370	crankshaft	DB	014 997 0047		01029683	
47748	65,00	90,00	10,00	A	NBR	18573		DB	304 997 0547			
114725	65,00	90,00	10,00	A	FPM	20627	crankshaft	ZF	0634 310 675		01029759	
35100	65,00	90,00	12,00	C	NBR	18578		MAN	06 56272 1614			
82212	65,00	90,00	13,00	BS	NBR	48401	differential	DB	004 997 1046			
47002	65,00	90,00	13,00	AW/BS RD vlies	FPM	84257	crankshaft	DB	004 997 7346	283983		
47673	65,00	90,00	13,00	AW/BS RD VL	FPM	84257	crankshaft	DB	009 997 9447		12014380	
47679	65,00	90,00	13,00	AW/BS RD F	FPM	84257	crankshaft	DB	010 997 5247	283983		81-20504-10
47732	65,00	90,00	13,00	AW/BS RD VL	FPM	84257	crankshaft	DB	013 997 3347			
98686	65,00	90,00	13,00	AW/BS RD VL	FPM	84257	crankshaft	DB	014 997 1646			
82131	65,00	90,00	13,00	AW/BS RD VL	FPM	84257	crankshaft	DB	014 997 1647	553272	01016759	81-20504-40
47736	65,00	90,00	13,00	AW/BS RD VL	FPM	84257	crankshaft	DB	014 997 6847			
109815	65,00	90,00	13,00	AW/BS RD VL	FPM	84257	crankshaft	DB	344 997 7446	553272		
114726	65,00	90,00	13,00	BS	NBR	48401	differential	ZF	0634 309 092		12015935	
47454	65,00	90,00	15,00	B RD	FPM	47957	crankshaft	DB	000 997 7947	283983		
35019	65,00	90,00	15,00	B RD	FPM	47957	crankshaft	DB	006 997 5446	283983	12014380	
47604	65,00	90,00	15,00	B RD	FPM	47957	crankshaft	DB	006 997 8547	283983		
47292	65,00	90,00	15,00	B RD	FPM	47957	crankshaft	DB	008 997 1446	283983		
48067	65,00	90,00	15,00	B RD	FPM	47957	crankshaft	DB	009 997 6146	283983		
47340	65,00	90,00	15,00	B RD	FPM	47957	crankshaft	DB	009 997 6246	283983		
47669	65,00	90,00	15,00	B RD	FPM	47957	crankshaft	DB	009 997 7747		20027937	
51726	65,00	90,00	15,00	B RD	MVQ	51726	crankshaft	DB	010 997 5247			
119109	65,00	90,00	13/14,50	KA/KB SP	FPM/ACM	109807	crankshaft	IVECO	4010 2290		12015928	
109804	65,00	90,00	13/14,50	KA/KB SP	FPM/ACM	109807	crankshaft	IVECO	4010 2293		12015928	
82927	65,00	100,00	10,00	B	NBR	18589		MAN	06 56271 1616			
113044	66,00	90,00	12,00	SP	PTFE	114371	crankshaft	MAN	51 01510 0219	061680	15027677	81-27522-10
109687	66,00	90,00	12,00	BS RD LA	FPM	109690	crankshaft	MAN	51 01510 0228	749983		81-34421-00
32333	66,67	89,30	10,00	AS W RD	FPM	32072	crankshaft	FORD	6 175 915		12015552	
93931	66,67	89,33	9,50	AS W RD	MVQ	93731	crankshaft	FORD	6 175 915			
114727	66,67	115,92/125,40	11,9/18,2	BS WD SF	FPM	114372	crankshaft	MAN	06 56279 0275		01016915	
97920	66,70	85,70	9,50	AS RD W	FPM	97919	crankshaft	FORD	1 087 556			

dph-no	dim 1	dim 2	dim 3	Style	Material	dph oil seal no.	Application	Type	OEM-NO	Eling	Corteco	Reinz
114728	67,00	94,00	13,00	SP	PTFE	114373		CATERPIL	9Y9895			
47402	68,00	80,00	9/10	BS	NBR	48056		DB	011 997 7646			
47420	68,00	80,00	9/10	BS	NBR	48056	crankshaft	DB	603 997 0046			
47580	68,00	85,00	10,00	B RD	FPM	48018	rear axle	DB	005 997 6747		01016878	
47582	68,00	85,00	10,00	B RD	FPM	48018	rear axle	DB	005 997 6947			
47583	68,00	85,00	10,00	B RD	FPM	48018	rear axle	DB	005 997 7647			
114729	68,00	85,00	10,00	A/B WD	FPM	114376	crankshaft	DB	018 997 5147		01029648	
61045	68,00	85,00	10,00	A	NBR	18565	crankshaft	DEUTZ	116 5286	494402		
112374	68,00	85,00	10,50	AS W RD	FPM/ACM	80375	BF6L913, BF6L912	DEUTZ	423 2266	033459	20020386	81-21527-30
47578	68,00	85,00	13,00	BS	NBR	95187	rear axle	DB	005 997 6647	562831	01027962	
47581	68,00	85,00	13,00	BS	NBR	95187		DB	005 997 6847	562831		
47584	68,00	85,00	13,00	BS	NBR	95187		DB	005 997 7747	562831		
98428	68,00	85,00	10/9,5	A/B RD	FPM	98432	differential	DB	016 997 6647	817449		
81595	68,00	85,00	10/9,5	A/BS	NBR	96320	differential	DB	016 997 6747	830798	01016877	
46898	68,00	90,00	10,00	A	NBR	4546	crankshaft	DB	001 997 1846	251720	12011012	
46976	68,00	90,00	10,00	A	NBR	4546	crankshaft	DB	003 997 8046			
47270	68,00	90,00	10,00	BS	NBR	95922	wheel hub	DB	007 997 8146		01026650	
47313	68,00	90,00	10,00	BS	NBR	95922	rear axle	DB	009 997 0546	008303	01026650	
47361	68,00	90,00	10,00	A	NBR	18598	crankshaft	DB	010 997 5046	251720		
114730	68,00	90,00	10,00	A/B WD	FPM	114377	differential	DB	017 997 2747		01020466	
35107	68,00	90,00	10,00	C	NBR	20037		MAN	06 56274 1714			
113942	68,00	90,00	10,00	A	NBR	4546	crankshaft	RVI	0024 411 680	251720	12011012	
114377	68,00	90,00	10,00	A/B WD	FPM	114377	rear axle	DB	007 997 3947			
61407	68,00	90,00	10,00	BS	NBR	95922	differential	MAN	06 56279 0327		01020465	
35101	68,00	90,00	12,00	C	NBR	24236		MAN	06 56272 1714			
80282	68,00	90,00	12,50	BS	NBR	50346	rear axle	MAN	06 56279 0184	008303	01026650	
46894	68,00	90,00	13,00	BS RD	FPM	47947	differential	DB	000 997 3846	331171		
47441	68,00	90,00	13,00	BS	NBR	50809		DB	000 997 3847			
47967	68,00	90,00	13,00	BS RD	FPM	47947	differential	DB	000 997 4446	033171		81-35083-00
46893	68,00	90,00	13,00	BS RD	FPM	47947	differential	DB	000 997 8946	331171		81-35083-00
47487	68,00	90,00	13,00	BS RD	FPM	47947		DB	002 997 1047	331171		81-35083-00
46964	68,00	90,00	13,00	BS RD	FPM	47947		DB	003 997 4446	331171	12012074	81-35083-00
47637	68,00	90,00	13,00	BS RD	FPM	47947	differential	DB	008 997 0747	331171	12012074	81-35083-00
47638	68,00	90,00	13,00	BS RD	FPM	47947	differential	DB	008 997 0847	331171	12012074	81-35083-00
47366	68,00	90,00	13,00	BS RD	FPM	47947	differential	DB	010 997 5746	331171		81-35083-00

Dimensions

Dimensions

dph-no	dim 1	dim 2	dim 3	Style	Material	dph oil seal no.	Application	Type	OEM-NO	Eling	Corteco	Reinz
47412	68,00	90,00	13,00	BS RD	FPM	47947	differential	DB	011 997 9846	331171	12012074	81-35083-00
84594	68,00	90,00	13,00	A/BS RD	FPM	114378	differential	DB	016 997 6847		01016880	
47617	68,00	90,00	10/9,50	B WD	FPM	47989	rear axle	DB	007 997 3947			
47619	68,00	90,00	10/9,50	B WD	FPM	47989	rear axle	DB	007 997 5047			
47269	68,00	90,00	10/9,50	B WD	FPM	47989	rear axle	DB	007 997 8046	008508		
47312	68,00	90,00	10/9,50	B WD	FPM	47989	rear axle	DB	009 997 0446	008508		
114731	68,00	90,00	10/9,50	B WD	FPM	47989	rear axle	MAN	06 56279 0209	008508		
93350	68,00	90,00	10/9,50	B WD	FPM	47989	differential	MAN	06 56279 0323		12012575	
113961	69,00	80,00	4,2/8,5	B OF SF	NBR	113960	rear axle	RVI	5000 387 566		12017138	
97903	69,60	99,97	20,7/12,7	AS WD SF	NBR	97902	wheel hub	FORD	6 143 629		12012569	
112600	70,00	79,00	5,30	B OF SF	NBR	112599	stub axle	DB	020 997 4947	222000	01026376	
47500	70,00	81,50	6,00	AW V	NBR	48009	front axle	DB	002 997 6547	331163	20016779	
47508	70,00	81,50	6,00	AW V	NBR	48009	front axle	DB	002 997 8847	331163	20016779	
117370	70,00	81,50	6,00	AW OF V	NBR	48009	wheel hub	EVOBUS	4 753 458 000			
96074	70,00	81,50	6,00	AW OF V	NBR	48009	wheel hub	EVOBUS	4 753 799 000			
47336	70,00	85,00	8,00	B	NBR	18606		DB	009 997 5746			
117312	70,00	85,00	8,00	A	MVQ	94942	crankshaft	FIAT	4000 4930			
95648	70,00	85,00	8,00	BS WD blue	NBR	95646	crankshaft	SCANIA	378 480			
46867	70,00	90,00	8,00	B	NBR	46868		DB	002 997 8646			
114735	70,00	90,00	10,00	AS W LD	FPM	47944		DAF	0140 784	348856	12014736	
104115	70,00	90,00	10,00	AW/BS RD	FPM	114379	crankshaft	DAF	1226 734	763144	12014700	81-15287-00
46908	70,00	90,00	10,00	AS W LD	FPM	47944	crankshaft	DB	001 997 8146	348856		
47484	70,00	90,00	10,00	A	NBR	18610		DB	002 997 0147			
46918	70,00	90,00	10,00	AS W LD	FPM	47944	gearbox	DB	002 997 1046	348856		
46959	70,00	90,00	10,00	AS W LD	FPM	47944		DB	003 997 3346	348856		
46960	70,00	90,00	10,00	AS W LD	FPM	47944	crankshaft	DB	003 997 3446			
47520	70,00	90,00	10,00	AS	NBR	18611	crankshaft	DB	003 997 3447		12011015	
47528	70,00	90,00	10,00	AS	NBR	18611	crankshaft	DB	003 997 6847		12011015	
47626	70,00	90,00	10,00	AS W LD	FPM	47944	gearbox	DB	007 997 6047	348856	12015772	
47275	70,00	90,00	10,00	AS W LD	FPM	47944		DB	007 997 8746			
47353	70,00	90,00	10,00	B	NBR	18612	crankshaft	DB	010 997 2446	246891	12011533	
47368	70,00	90,00	10,00	B	NBR	18612	crankshaft	DB	010 997 6046	246891	12011533	
47701	70,00	90,00	10,00	B	NBR	18612	gearbox	DB	010 997 9647	246891	12011533	
47390	70,00	90,00	10,00	B	NBR	18612	crankshaft	DB	011 997 3346	246891		
95270	70,00	90,00	10,00	AW/BS WD	FPM	114382	gearbox	DB	017 997 6647		01025713	

dph-no	dim 1	dim 2	dim 3	Style	Material	dph oil seal no.	Application	Type	OEM-NO	Eling	Corteco	Reinz
47750	70,00	90,00	10,00	A	NBR	18610		DB	304 997 0747			
47751	70,00	90,00	10,00	AS	NBR	18611	crankshaft	DB	304 997 0847		12011015	
112541	70,00	90,00	10,00	AW/BS WD	FPM	114382	gearbox	DEUTZ	446 0152		12013363	
48473	70,00	90,00	10,00	BS LD	MVQ	48472	crankshaft	LADA	2101 100 5160		12011438	81-15287-10
84398	70,00	90,00	10,00	B	NBR	18612	gearbox	MAN	06 56271 3814			
114734	70,00	90,00	10,00	AW/BS WD	FPM	114382	gearbox	MAN	06 56279 0211		12013363	
35206	70,00	90,00	10,00	B	NBR	18162	crankshaft	MAN	81 96501 0308		01002684	
114736	70,00	90,00	10,00	AS W LD	FPM	47944	gearbox	MAN	81 96502 0251		12014736	
110713	70,00	90,00	10,00	A LD	NBR	61487	front&rear axle	SCANIA	125 766			
70272	70,00	90,00	10,00	B	NBR	18612	injection pump	VOLVO	192 600-5	246891		
114737	70,00	90,00	10,00	AS W LD	FPM	47944	gearbox	VOLVO	6 876 131-1		12014736	
114733	70,00	90,00	10,00	AS	NBR	18611	gearbox	VOLVO	6 876 132-9		12011015	
4582	70,00	90,00	10,00	A LD	NBR	61487	crankshaft	VW	113 105 245 F			
81485	70,00	90,00	10,00	A LD	ACM	81487	crankshaft	VW	113 105 245 F	042102	12001482	81-15287-30
97605	70,00	90,00	10,00	A LD F	MVQ	97640	crankshaft	VW	113 105 245 FD			81-15287-40
34202	70,00	90,00	10,00	AS LD	MVQ	50760	crankshaft	VW	113 105 245 FS	513326		81-15287-10
35509	70,00	90,00	10,00	A LD	NBR	61487	crankshaft	VW	113 105 245 G			
84767	70,00	90,00	10,00	B	NBR	18612	crankshaft	ZF	0734 300 104		01029757	
114738	70,00	90,00	10,00	AS W LD	FPM	47944	gearbox	ZF	0734 310 128		12014736	
82342	70,00	90,00	12,00	AS RD	ACM	82341	crankshaft	DAF	0240 631	760544		
119100	70,00	90,00	12,00	A/CS WD W	ACM	81631	wheel hub	IVECO	4010 0480		12014289	
81571	70,00	90,00	12,00	A/CS WD W	ACM	81631	wheel hub	IVECO	4010 0483		12014289	
93699	70,00	90,00	12,00	A/CS WD W	ACM	81631		IVECO	7010 0303			
35102	70,00	90,00	12,00	C	NBR	18616	wheel hub	MAN	06 56272 1814		12011410	
94303	70,00	90,00	12,00	C	FPM	94302	crankshaft	MAN	06 56279 0236		01012087	
35109	70,00	90,00	13,00	C	NBR	18619		MAN	06 56279 0019	042161		
114740	70,00	90,00	15,50	AW/BS WD	FPM	114384	transfer gearbox	DB	012 997 5247		01028962	
114492	70,00	90,00	12/8	AS	NBR	114432	gearbox	RVI	5000 132 770		12011015	
97053	70,00	90,00	10/14	combi	NBR	114383	gearbox	DB	007 997 9646		01029728	
114739	70,00	90,00	10/14	SP	NBR	114383	crankshaft	MAN	06 56279 0064		01029728	
119107	70,00	90,00	13,5/14,50	SP	FPM	95465	crankshaft	IVECO	4010 2270		12015793	
94797	70,00	90,00	13,5/14,50	SP	FPM	95465	crankshaft	IVECO	4010 2273	013930	12015793	
115735	70,00	92,00	12,00	AS LD	FPM	115734		Mitsubishi	31A07-02300			
97087	70,00	92,00	12,00	AS	ACM	97084		Mitsubishi	MH034154			
35126	70,00	95,00	13,00	C	NBR	18623		MAN	06 56279 0066			

Dimensions

Dimensions

dph-no	dim 1	dim 2	dim 3	Style	Material	dph oil seal no.	Application	Type	OEM-NO	Elring	Corteco	Reinz
114741	70,00	95,00	13/14,5	KA SP	NBR	110618		DB	022 997 1247	354080		
82282	70,00	100,00	12,00	A	NBR	84533	engine various	DB	005 997 0846			
117399	70,00	100,00	12,00	A	NBR	84533	crankshaft	IVECO	3851 4100	325473	12011017	
110727	70,00	100,00	12,00	A	NBR	84533	engine various	IVECO	851 101	325473	12011017	
35103	70,00	100,00	12,00	C	NBR	18630	crankshaft	MAN	06 56272 1816			
70486	70,00	100,00	12,00	A	NBR	84533	crankshaft	SCANIA	33 326	325473	12011017	
114742	70,00	100,00	13,00	A/CS WD W	ACM	81355	wheel hub	IVECO	4010 1700		12014381	
118923	70,00	100,00	13,5/15,00	KS SP	FPM	114864	wheel hub	IVECO	4010 2280		12014381	
114743	70,00	100,00	13,5/15,00	KS SP	FPM	114864	wheel hub	IVECO	4010 2283		12014381	
112976	70,00	102,00	14,50	AS W LD SP	FPM	112987	crankshaft	VOLVO	1 524 838		12013988	
82225	70,00	110,00	13,00	C	NBR	18638		DB	006 997 9647			
4074	72,00	85,60	18,00	B blue	NBR	70313	front axle	DB	005 997 1646	009360	16011841	
120472	72,00	90,00	12/9,5	A/B WD	NBR	96429	crankshaft	DB	024 997 5547		01016959	
114503	72,00	90,00	12/9,5	A/B WD	NBR	96429	crankshaft	SCANIA	1 426 876		01016959	
96325	72,00	90,00	12/9,5	A/B WD	NBR	96429	crankshaft	ZF	0734 300 185		01016959	
114744	72,00	92,00	13,00	SP	PTFE	114385		CATERPIL	7C6660			
82349	72,00	100,00	10,00	A	NBR	18646	crankshaft	DAF	0325 321		12011019	
47307	72,00	105,00	13,00	CS	NBR	50344	front axle	DB	008 997 9446			
47321	72,00	105,00	13,00	BS	NBR	4767	front & rear axle	DB	009 997 1046			
47331	72,00	105,00	13,00	BS	NBR	4767	front & rear axle	DB	009 997 4546	008559	12012573	
47344	72,00	105,00	13,00	BS	NBR	4767	front&rear axle	DB	009 997 9146	008559	12012573	
47360	72,00	105,00	13,00	C WD	FPM	48048	front axle	DB	010 997 3746	008745	12014743	
47362	72,00	105,00	13,00	C WD	FPM	48048	front axle	DB	010 997 5346	008745	12014743	
47715	72,00	105,00	13,00	BS	NBR	4767	front&rear axle	DB	011 997 7047	008559	12012573	
95009	72,00	105,00	13,00	C WD	FPM	48048	front axle	DB	013 997 4947		12014743	
35110	72,00	105,00	13,00	BS green	NBR	4767	front&rear axle	MAN	06 56279 0028	008559	12012573	
46636	72,00	105,00	13,00	C WD	FPM	48048	front axle	MAN	06 56279 0073	008745	12014743	
69160	72,00	105,00	13,00	BS	NBR	4767	front&rear axle	MAN	06 56279 0312	008559	12012573	
117300	72,00	105,00	13,00	C WD	FPM	48048	differential	MAN	06 56279 0366		12014743	
70527	72,00	105,00	13,00	BS	NBR	4767	front&rear axle	SCANIA	386 967	008559		
70528	72,00	105,00	13,00	C WD	FPM	48048	transfer gearbox	SCANIA	386 968	008745	12014743	
109854	72,00	105,00	19,00	SP	FPM/ACM	109858	differential	DB	020 997 0647	023330	01026188	
47503	72,00	84/85,5	18,00	BS	NBR	48057	rear axle	DB	002 997 7047			
47016	72,00	84/85,6	18,00	BS	NBR	48057	rear axle	DB	005 997 2346			
48038	72,00	84/85,6	18,00	BS	NBR	48057	rear axle	DB	005 997 2446			

dph-no	dim 1	dim 2	dim 3	Style	Material	dph oil seal no.	Application	Type	OEM-NO	Elring	Corteco	Reinz
47653	72,00	84/85,6	18,00	BS	NBR	48057	rear axle	DB	008 997 4147			
47380	72,00	84/85,6	18,00	BS	NBR	48057	rear axle	DB	011 997 0546			
15261	72,00	84/85,6	18,00	BS	NBR	48057	rear axle	DB	011 997 0646	018813	16011841	
47403	72,00	84/85,6	18,00	BS	NBR	48057	rear axle	DB	011 997 7846			
47421	72,00	84/85,6	18,00	BS	NBR	48057	rear axle	DB	603 997 0346		20017102	
112564	73,00	93,00	10/12,5	A/B WD	ACM	113928	differential	DB	014 997 9747		01020048	
84467	73,00	94,00	9/14	A/B WD	ACM	84728	differential	DB	014 997 7247		01033977	
95233	73,02	101,60	15,87	SP	HNBR	95455	wheel hub	MF	3699800M2		12018598	
111771	74,00	90,00	10,00	A/BS LD	ACM	111770	crankshaft	FIAT	4000 2740		12001483	
111774	74,00	90,00	10,00	A/BS LD	FPM	111773	crankshaft	FIAT	6080 5182	440830	12001540	
114746	74,00	95,00	11,00	AW/BS RD F	FPM	110391	crankshaft 1012	DEUTZ	425 3372	084790	01027764	81-36021-00
113967	75,00	90,00	8,00	A W WD	NBR	113966	wheel hub	RVI	5000 515 606		07016734	
112880	75,00	90,00	8,00	AS W RD	FPM	112880						
84541	75,00	90,00	10/11	BABSL	NBR	84540	crankshaft	SCANIA	294 275		12001716	
114747	75,00	90,00	10/12,3	AW/BS WD	NBR	114386	wheel hub	DB	024 997 6847		01031066	
114748	75,00	93,00	8,00	SP	PTFE	114387		CUMMINS	3921927			
46885	75,00	95,00	10,00	A	NBR	6638	crankshaft	DB	000 997 5046	528102		
35697	75,00	95,00	10,00	A blue	NBR	6638	crankshaft	DB	000 997 5646	528102	12011020	
46944	75,00	95,00	10,00	A/B WD	FPM	47938		DB	002 997 5646			
46861	75,00	95,00	10,00	A/B WD	FPM	47938	differential	DB	002 997 7546	006394		
46957	75,00	95,00	10,00	A	NBR	6638	crankshaft	DB	003 997 3046	528102		
46962	75,00	95,00	10,00	A/B WD	FPM	47938		DB	003 997 3846	006394		
47293	75,00	95,00	10,00	C	NBR	18657	engine various	DB	008 997 2146			
111632	75,00	95,00	10,00	A/B WD	FPM	47938		DB	017 997 3147		01016962	
35093	75,00	95,00	10,00	B	NBR	18656		MAN	06 56271 2015			
114749	75,00	95,00	10,00	A/B WD	FPM	47938	differential	MAN	06 56279 0331	104310	01016962	
113938	75,00	95,00	10,00	A	NBR	6638	crankshaft	RVI	5010 216 049		01030103	
35053	75,00	95,00	10,00	AW LD	FPM/ACM	95002	crankshaft	VW	029 105 245 B	326798	20019852	
35671	75,00	95,00	12,00	AW LD	FPM	61491	crankshaft	VW	021 105 245 B			
6703	75,00	95,00	12,00	AW LD	MVQ	34962	crankshaft	VW	021 105 245 C			
23052	75,00	95,00	12,00	AW LD	FPM	61491	crankshaft	VW	029 105 245			
48119	75,00	95,00	12,50	BS	NBR	50347	camshaft	MAN	06 56279 0183	008370	01019460	
47564	75,00	95,00	12,50	BS	NBR	50347	camshaft	DB	005 997 1047	008370		
47566	75,00	95,00	12,50	BS	NBR	50347	camshaft	DB	005 997 1247	008370		
47567	75,00	95,00	12,50	BS	NBR	50347	camshaft	DB	005 997 1847	008370		

Dimensions

Dimensions

dph-no	dim 1	dim 2	dim 3	Style	Material	dph oil seal no.	Application	Type	OEM-NO	Eling	Corteco	Reinz
47324	75,00	95,00	12,50	BS	NBR	50347	camshaft	DB	009 997 1546	008370	01019460	
47446	75,00	95,00	13,00	A/BS	NBR	48021	rear axle	DB	000 997 4647	562866		81-35087-00
47448	75,00	95,00	13,00	CS	NBR	51719	gearbox	DB	000 997 5347			
46888	75,00	95,00	13,00	CS	NBR	51719	gearbox	DB	000 997 6346			
34672	75,00	95,00	13,00	CS green	NBR	51719	gearbox	DB	000 997 6347	529001	12013987	81-35086-00
47294	75,00	95,00	13,00	A/BS	NBR	48021	rear axle	DB	008 997 2246			
47683	75,00	95,00	13,00	A/BS	NBR	48021	rear axle	DB	010 997 5747	562866	12015884	
47689	75,00	95,00	13,00	A/BS	NBR	48021	rear axle	DB	010 997 7147	562866	12015884	
47387	75,00	95,00	13,00	CS	NBR	51719	gearbox	DB	011 997 2546	529001	12013987	
47730	75,00	95,00	13,00	A/BS	NBR	48021	rear axle	DB	013 997 1147	562866	12015884	81-35087-00
51472	75,00	95,00	15,50	AW/BS WD	FPM	51471	differential	DB	010 997 0547		01025711	
96336	75,00	95,00	15,50	AW BS WD	FPM	51471	differential	DB	015 997 6847		01025711	
114750	75,00	95,00	12/13	A/BS RD Vlies	FPM	112929	crankshaft	DB	011 997 1447		01026179	
112930	75,00	95,00	12/13	A/BS RD Vlies	FPM	112929		DB	013 997 2247			
114751	75,00	95,00	10/15	A/BS WD	FPM	114388	differential	DB	020 997 3347		01020043	
47563	75,00	95,00	10/9,50	B WD	FPM	4380	transfer gearbox	DB	005 997 0947	327263	01019459	
47565	75,00	95,00	10/9,50	B WD	FPM	4380	transfer gearbox	DB	005 997 1147	327263		
47568	75,00	95,00	10/9,50	B WD	FPM	4380	transfer gearbox	DB	005 997 1947	327263		
6549	75,00	95,00	10/9,50	B WD	FPM	4380	transfer gearbox	DB	007 997 4747			
47620	75,00	95,00	10/9,50	B WD	FPM	4380	transfer gearbox	DB	007 997 5147			
47323	75,00	95,00	10/9,50	B WD	FPM	4380	transfer gearbox	DB	009 997 1446	327263		
81190	75,00	95,00	10/9,50	B WD	FPM	4380	transfer gearbox	MAN	06 56279 0215	327363	01019459	
113976	75,00	95,00	10/9,50	B WD	FPM	4380	differential	RVI	5010 319 684		01019480	
113149	75,00	95,00	9,5/10	A/BS	NBR	114110	differential	DB	017 997 3047	104320	01020042	
69845	75,00	95,00	9,5/10	A/BS	NBR	114110	differential	MAN	06 56279 0335	104320	01020042	
47539	75,00	100,00	10,00	A	NBR	84535	gearbox	DB	004 997 1347	530107	12011021	
114752	75,00	100,00	10,00	A	NBR	84535	wheel hub	IVECO	3851 0549	530107	12011021	
110726	75,00	100,00	10,00	A	NBR	84535	gearbox	IVECO	843 075		12011021	
3888	75,00	100,00	10,00	A blue	NBR	84535	gearbox	SCANIA	33 352	530107	12011021	
109721	75,00	100,00	10,00	BS RD	FPM	109725	gearbox	ZF	0750 111 231		20034262	
114875	75,00	100,00	11,00	AW/BS blue	NBR	114874	wheel hub	DB	019 997 5847	457120	12018888	
47506	75,00	100,00	12,00	B	NBR	18667	wheel hub	DB	002 997 8447	531006		81-35294-00
47507	75,00	100,00	12,00	B	NBR	18667	wheel hub	DB	002 997 8547	531006		
35106	75,00	100,00	12,00	C	NBR	18668		MAN	06 56272 2016			
84399	75,00	100,00	12,00	C	FPM	84438	rear axle	MAN	06 56272 8016			

dph-no	dim 1	dim 2	dim 3	Style	Material	dph oil seal no.	Application	Type	OEM-NO	Eling	Corteco	Reinz
110092	75,00	100,00	12,00	AS W	NBR	113611	crankshaft	VOLVO PC	968 844-1		12002219	
46852	75,00	100,00	13,00	CS	NBR	97437	wheel hub	DB	000 997 1446	105414	12011411	
47523	75,00	100,00	13,00	B	NBR	20038		DB	003 997 4647			
96317	75,00	100,00	13,00	B	NBR	20038		DB	004 997 4547			
117400	75,00	100,00	13,00	CS	NBR	97437	gearbox	IVECO	4000 1830		12011411	
83897	75,00	100,00	13,00	CS	NBR	97437	gearbox	IVECO	4000 1880		12011411	
114754	75,00	100,00	13,00	CS	NBR	97437	gearbox	IVECO	883 6666		12011411	
117299	75,00	100,00	13,00	B	NBR	20038		MAN	81 96501 0485			
97088	75,00	100,00	13,00	AS LD	ACM	97085		Mitsubishi	MH034155			
114755	75,00	100,00	10/13	KA	NBR	114389	wheel hub	SCANIA	1 313 719		12017173	
112282	75,00	100,00	10/13	KA	NBR	114389	wheel hub	SCANIA	1 409 890	222610	12017173	
46904	75,00	100,00	12/13,00	BS RD F	FPM	36208	crankshaft	DB	001 997 5246	525316		
47522	75,00	100,00	12/13,00	BS RD F	FPM	36208	crankshaft	DB	003 997 4547	525316		
47544	75,00	100,00	12/13,00	BS RD F	FPM	36208	crankshaft	DB	004 997 3947	525316	12011674	
46997	75,00	100,00	12/13,00	BS RD	FPM	36208	crankshaft	DB	004 997 6046	525316	12011674	
47585	75,00	100,00	12/13,00	BS RD F	FPM	36208	crankshaft	DB	005 997 8247	525316	12011674	
47713	75,00	100,00	12/13,00	BS RD F	FPM	36208	crankshaft	DB	011 997 5647	525316	12011674	
36221	75,00	100,00	12/13,00	BS RD	FPM	36208	crankshaft	DB	011 997 5747	525316	12011674	81-20309-20
47399	75,00	100,00	12/13,00	BS RD F	FPM	36208	crankshaft	DB	011 997 6946	525316		
47400	75,00	100,00	12/13,00	BS RD F	FPM	36208	crankshaft	DB	011 997 7046	525316	12011674	
47415	75,00	100,00	12/13,00	BS RD F	FPM	36208	crankshaft	DB	345 997 7746	525316		
96504	75,00	100,00	9,5/12,5	AS WD SF	NBR	97147	crankshaft	DB	006 997 0547		01031732	
114494	75,00	102,00	14,00	BS SP combi	NBR	114442	gearbox	RVI	5000 819 970			
109576	75,00	106,00	10,00	AS	FPM	109576						
109785	75,00	110/134,00	10/17	BS SP	NBR	109790	axle, with pulse wheel	DB	970 997 0446		01033904	
115421	75,50	107,00	8,00	AS W LD	FPM	115437	crankshaft	BMW	11 14 7 790 960		19026734	
96923	75,50	108,00	10/19,5	SPT4A29	NBR	96922	wheel hub	Toyota	90311-75003		19016652	
113669	76,00	94,00	9,00	A/B	NBR	113668	crankshaft	MAN	06 56279 0315		01019465	
109808	76,00	100/137,00	10/15,5	SP	FPM	109812	ABS with pulse wheel	MAN	81 52403 6000		01019466	
36300	76,20	101,60	11,90	A/BS RD felt	FPM	94792	crankshaft	VOLVO	471 055-4		12014191	
80733	76,20	101,60	11,90	A RD	MVQ	80733	crankshaft	VOLVO	471 055-4			
82787	76,20	101,60	11,90	A RD	MVQ	80733	crankshaft	VOLVO	477 118-4			
110485	76,20	101,60	11,90	A/BS RD VL	FPM	94792	crankshaft	VOLVO	477 118-4	754669	01016760	81-31168-00
15254	77,00	100,10	11,45	AW/BS LD	FPM	15248	crankshaft	OPEL	614 815	694665	12013857	81-20667-30
46725	77,00	98,4/103,00	6,3/19,3	A OF SF	NBR	82906	wheel hub	VOLVO	1 610 078		12013127	

Dimensions

Dimensions

dph-no	dim 1	dim 2	dim 3	Style	Material	dph oil seal no.	Application	Type	OEM-NO	Elring	Corteco	Reinz
114757	78,00	100,00	10,00	AW/BS LD	FPM	114390	crankshaft	IVECO	4010 0490		12013860	
114756	78,00	100,00	10,00	AW/BS LD	FPM	114390	crankshaft	MAN	81 32050 0451		12013860	
3903	78,00	100,00	10,00	A LD	MVQ	3902	crankshaft	PEUGEOT	0514 14	034347		81-23578-00
114390	78,00	100,00	10,00	AW BS LD	FPM	114390	crankshaft	PEUGEOT	0514 14		12013860	
84764	78,00	100,00	14,50	A/B RD Vlies	FPM	84763	crankshaft	MWM	6 226 0 856 0014			
113041	78,00	104,00	11,00	AW/BS RD	PTFE	114391	crankshaft	DB	022 997 7647	445591	20025510	81-36198-00
111375	78,00	115,00	13/17	BS RD SP	FPM	111388	differential	DAF	1283 668		01017058	
114758	78,00	135,00	12/21,5	SP	FPM/ACM	114392	differential	DB	018 997 7647	221710	01030117	
116665	79,00	99,00	9,60	AS LD SP	FPM	97924	crankshaft	FORD	6 182 960			
109059	79,38	95,25	11,00	AW BS LD	MVQ	80680	crankshaft	FORD	1 472 927	763713	15011263	
93703	79,38	95,25	11,00	AW/BS LD	MVQ	80680	crankshaft	FORD	1 614 763	763713	15011263	
93704	79,38	95,25	11,00	AW/BS LD	MVQ	80680	crankshaft	FORD	1 614 764	763713	15011263	
80637	79,38	95,25	11,00	AW/BS LD	MVQ	80680	crankshaft	FORD	1 641 893			
80636	79,38	95,25	11,00	AW/BS LD	FPM	80636	crankshaft	FORD	1 641 893	763713	12015675	
116379	79,38	95,25	11,00	AW/BS LD	FPM	80636	crankshaft	FORD	6 112 201		12015675	
84614	80,00	95,00	8,00	A	NBR	35192	crankshaft	DAF	0010 588	043737	07013486	81-35088-00
113982	80,00	95,00	8,00	A W WD	NBR	113981	wheel hub	RVI	5516 015 803		07013486	
114759	80,00	95,00	8,00	A W WD	NBR	113981	wheel accessory kit	VOLVO	947 269-7	043737	07013486	
37638	80,00	98,00	10,00	AS LD	MVQ	37638	transfer gearbox	OPEL	614 811			
37640	80,00	98,00	10,00	A/BS LD	FPM	81060	crankshaft	OPEL	614 811		12013882	
37638	80,00	98,00	10,00	AS LD	MVQ	37638	transfer gearbox	OPEL	614 820			
50179	80,00	98,00	10,00	A/BS LD	FPM	81060	crankshaft	OPEL	614 820		12013882	81-24908-10
81062	80,00	98,00	10,00	A/BS LD	FPM	81060	crankshaft	OPEL	614 821	590797	12013882	81-24908-10
94499	80,00	98,00	10,00	A/BS LD	FPM	81060	crankshaft	OPEL	614 830	590797	12013882	81-24908-10
82436	80,00	100,00	8,00	AS W LD	FPM/ACM	82435	crankshaft	RENAULT	77 00 859 692	507822	12015352	
120086	80,00	100,00	8,50	AS LD	MVQ	120087	crankshaft	Toyota	90311-80007		19015091	81-53319-00
109981	80,00	100,00	9,00	A LD	PTFE	109980	crankshaft	DB	160 997 0146	745740	20030112	81-35051-00
94549	80,00	100,00	10,00	A LD SP	ACM	94548		BMW	11 11 1 261 739			
94550	80,00	100,00	10,00	A LD SP	ACM	94548		BMW	11 11 1 337 674			
109164	80,00	100,00	10,00	A green	NBR	4306	front-/rear axle	DAF	0572 372			
47543	80,00	100,00	10,00	AS	NBR	18682		DB	004 997 2047	108499		
47008	80,00	100,00	10,00	A	FPM	20638	crankshaft	DB	004 997 9546			
4049	80,00	100,00	10,00	A green	NBR	4306	front-/rear axle	DB	004 997 9646	546038	12011026	
47012	80,00	100,00	10,00	A green	NBR	4306	front-/rear axle	DB	005 997 1046	546038	12011026	
47037	80,00	100,00	10,00	B	NBR	18683	gearbox	DB	005 997 9746	042390		

dph-no	dim 1	dim 2	dim 3	Style	Material	dph oil seal no.	Application	Type	OEM-NO	Elring	Corteco	Reinz
47273	80,00	100,00	10,00	A green	NBR	4306	front-/rear axle	DB	007 997 8346		12011026	
47635	80,00	100,00	10,00	AW/BS WD	FPM	47995	differential	DB	007 997 9847			
47655	80,00	100,00	10,00	AW/BS WD	FPM	47995	gearbox	DB	008 997 7547		01016881	
47705	80,00	100,00	10,00	A green	NBR	4306	front-/rear axle	DB	011 997 1847			
96337	80,00	100,00	10,00	AW/BS WD	FPM	47995	differential	DB	017 997 2547		01020467	
93378	80,00	100,00	10,00	BS	NBR	42528	rear axle	DB	017 997 7947	104330	01020468	
112974	80,00	100,00	10,00	AS	NBR	112974	rear axle	DB	017 997 7947			
110739	80,00	100,00	10,00	A green	NBR	4306	front-/rear axle	IVECO	3850 5699	546038	12011026	
114485	80,00	100,00	10,00	AW/BS WD	FPM	47995	differential	IVECO	4010 0860		12015770	
48469	80,00	100,00	10,00	AS W LD	MVQ	48468	crankshaft	LADA	2108 100 5160	546941		
80358	80,00	100,00	10,00	AW/BS WD	FPM	47995	differential	MAN	06 56289 0349	104290	01020467	
61486	80,00	100,00	10,00	BS	NBR	42528	crankshaft	MAN	06 56289 0353	104330	01020468	
113965	80,00	100,00	10,00	AS W WD blue	NBR	113964	wheel hub	RVI	5000 392 404		07016735	
70446	80,00	100,00	10,00	A green	NBR	4306	front-/rear axle	SCANIA	120 979	546038	12011026	
70474	80,00	100,00	10,00	B	NBR	18683	gearbox	SCANIA	216 608	042390		
110716	80,00	100,00	10,00	A green	NBR	4306	front-/rear axle	SCANIA	227 138			
117539	80,00	100,00	10,00	A/BS RD	ACM	120475	retainer water pump	VOLVO	1 543 908-6		12017220	
35805	80,00	100,00	10,00	BS LD LA	FPM	35886		VOLVO	267 269	587966	12013361	81-35169-00
110723	80,00	100,00	10,00	BS LD LA	FPM	35886	PB 269	VOLVO	943 704-7	587966	12013361	81-35169-00
70020	80,00	100,00	10,00	B	NBR	18683	gearbox	VOLVO	959 042-3		01002942	
47035	80,00	100,00	12,00	B	FPM	47315		DB	005 997 9646	042420		
47616	80,00	100,00	12,00	B	FPM	47315		DB	007 997 3847	042420		
47618	80,00	100,00	12,00	B	FPM	47315		DB	007 997 4947	042420		
47274	80,00	100,00	12,00	BS	NBR	50348	rear axle	DB	007 997 8446	008354	01025712	
47317	80,00	100,00	12,00	B	FPM	47315		DB	009 997 0646	042420		
47318	80,00	100,00	12,00	BS	NBR	50348	rear axle	DB	009 997 0746	008354	01025712	
47342	80,00	100,00	12,00	BS	NBR	50348	rear axle	DB	009 997 7846	008354		
34633	80,00	100,00	12,00	BS blue	NBR	50348	rear axle	MAN	06 56289 0022	008354		
113662	80,00	100,00	12,00	BS	NBR	50348	crankshaft	MAN	06 56289 0179		01017034	
80482	80,00	100,00	12,00	B	FPM	47315	crankshaft	MAN	06 56289 0191	042420		
34421	80,00	100,00	12,00	BS RD LA	FPM	34420	crankshaft	SCANIA	338 643	527823	12011821	81-25013-20
109114	80,00	100,00	13,00	A/BS W LD	MVQ	37509	crankshaft back	BMW	11 14 1 255 015	128210	19030094	81-18304-00
47027	80,00	100,00	13,00	C RD	MVQ	48041	gearbox	DB	005 997 5746			
95374	80,00	100,00	13,00	AS RD	MVQ	95374		I.H.C.				
82480	80,00	100,00	13,00	A/BS W LD	MVQ	37509	crankshaft	RENAULT	77 03 087 080	128210	19930094	

Dimensions

Dimensions

dph-no	dim 1	dim 2	dim 3	Style	Material	dph oil seal no.	Application	Type	OEM-NO	Elring	Corteco	Reinz
94928	80,00	100,00	13,00	BS blue	NBR	94928	rear axle	SCANIA	124 268	042463		
111285	80,00	100,00	13,00	AS SP	PTFE	111403	crankshaft	SCANIA	369 477	382100	20017234	81-25013-30
36169	80,00	100,00	13,00	BS blue	NBR	94928	crankshaft	SCANIA	388 728		12015254	
33549	80,00	100,00	13,00	A/BS LD W	MVQ	37509	crankshaft	VOLVO PC	1 218 027		19030094	81-18304-00
83884	80,00	100,00	13,00	A/BS W LD	MVQ	37509	crankshaft	VOLVO PC	3 267 244-6		19030094	
97891	80,00	100,00	13,00	BS	NBR	94928	rear axle	ZF	0634 309 104			
84730	80,00	100,00	10/8	BS WD LA	ACM	112617	crankshaft	SCANIA	1 335 243		12015254	
34426	80,00	100,00	13/15	CS WD SF	ACM	118176	rear axle	SCANIA	124 268		12015254	
98284	80,00	105,00	10,00	SP	FPM	109859	crankshaft	DB	018 997 7147		01026470	
114761	80,00	105,00	12,00	SP	PTFE	114396	crankshaft	CUMMINS	3010457			
35145	80,00	105,00	15,00	B green	NBR	81545		MAN	06 56289 0031			
48166	80,00	108,00	11,10	AW/BS LD	MVQ	48166						
34435	80,00	110,00	10,00	A	NBR	18694	crankshaft	SCANIA	304 552		12011029	
116345	80,00	110,00	10,00	A W	FPM	116411	wheel hub	ZF	0734 310 333			
117416	80,00	110,00	12,00	A	NBR	18698	crankshaft	IVECO	3851 2262		12011030	
117402	80,00	110,00	13,00	A	NBR	18701	gearbox	IVECO	540 727		12011031	
117308	80,00	110,00	13,00	C	FPM	109292		MAN	06 56289 0028			
59232	80,00	110,05	12,00	BS LD	FPM	95248	differential	VOLVO	948 448-6		12013871	81-35141-00
114762	80,00	120,00	13/17	AW/BS RD	FPM	114397	differential	DAF	1287 103		01029753	
116232	80,00	130,20	12/20	SP RD LA	ACM	69294	automatic gearbox	VOLVO	1 522 895			
36626	80,00	130,20	12/20	RD LA SP	FPM	82426	automatic gearbox	VOLVO	1 522 895	588016	12014745	81-35131-00
69293	80,00	150,00	12/20	SP RD LA	FPM	69292	differential carrier	VOLVO	1 522 894	588008	12014744	81-35129-00
111376	80,00	110/115,00	10/13	KA	FPM	111389	crankshaft	IVECO	4010 2301		12033893	
114783	80,00	135/154,00	13,5/18	BS RD SP	FPM	114398	crankshaft	MAN	06 56289 0293	379300	01020677	
113664	81,00	100,00	10,00	A/B	NBR	113663	crankshaft	MAN	06 56289 0320		01027678	
96023	81,00	100,10	11,45	AW/BS LD	FPM	97870	crankshaft	OPEL	614 805		12010747	
50705	81,00	100,10	11,45	AW/BS LD	FPM	97870	crankshaft	OPEL	614 816	694673	12010747	81-24077-00
50823	81,00	100,10	11,45	AW/BS LD	MVQ	50823	crankshaft	OPEL	614 816			
93234	81,00	100,10	11,45	AW/BS LD	MVQ	50823	crankshaft	OPEL	614 824			
97871	81,00	100,10	11,45	AW/BS LD	FPM	97870	crankshaft	OPEL	614 826		12010747	
96681	81,00	104,00	11,00	AW/BS RD V	FPM	96231	oil pump	DEUTZ	425 3373	084920	01027762	81-35999-00
109809	81,00	100/137,00	10/15,5	SP	FPM	109813	ABS with pulse wheel	MAN	81 52403 6001	265960	01026330	
114481	82,00	105,00	10,00	AS2	NBR	114447	wheel hub	DAF	1400 080		01034436	
109140	82,00	105,00	12,00	AS W LD	FPM	3914	crankshaft	ALFA	60517110	232300	12013892	
3915	82,00	105,00	12,00	AS W LD	FPM	3914	crankshaft	VW	056 103 051 A	232300	12013892	

dph-no	dim 1	dim 2	dim 3	Style	Material	dph oil seal no.	Application	Type	OEM-NO	Elring	Corteco	Reinz
118601	83,00	100,00	9,00	AS LD	MVQ	110016		KIA	0K201 11 312			81-53404-00
118600	83,00	100,00	9,00	AS LD	MVQ	110016	crankshaft	MAZDA	BP05-011-312			
109145	84,00	105,00	12,00	AS W LD	MVQ	50510	crankshaft	ALFA	119 00 01 177 00		12015180	
95649	84,93	104,77	18,26	SP1 RD	FPM/ACM	112634	crankshaft	SCANIA	1 383 129		12018653	
98061	84,93	104,77	18,26	SP1 RD	FPM/ACM	112634	crankshaft	SCANIA	1 386 594	222630	12018653	
112585	84,93	104,77	18,26	SP1 RD	FPM/ACM	112634	crankshaft	SCANIA	1 502 385	222630	12018653	
98060	84,93	104,77	12/18,26	SP2 LD	FPM/ACM	112636	front axle	SCANIA	1 393 331	222640	12018654	
111330	84,93	104,77	12/18,26	SP2 LD	FPM/ACM	112636	crankshaft	SCANIA	1 502 384	222640	12018654	
119280	85,00	100,00	12,00	AS	NBR	44179		KHD	116 0856			
119216	85,00	105,00	7,50	BABSL1	NBR	119216						
84462	85,00	105,00	8,00	ASW LD	FPM/ACM	112606	crankshaft	PEUGEOT	0514 74	135110	20018066	81-23708-50
115415	85,00	105,00	8,00	AS W LD	ACM/FPM	109243	camshaft	RENAULT	77 03 087 190	508462	12015424	81-23708-50
93567	85,00	105,00	8,00	AS	NBR	84573	crankshaft	STEYR	90 003 070 027			
83885	85,00	105,00	8,00	AS W LD	ACM/FPM	109243	crankshaft	VOLVO PC	3 287 542-9	508462		81-23708-50
114057	85,00	105,00	8,80	AS W LD	ACM/PTFE	114094	crankshaft	FORD	1 142 360	026790	20029117	81-35553-00
111583	85,00	105,00	10,00	AW/BS LD	FPM	82528	gearbox	DAF	0140 783	033464	12013757	
114766	85,00	105,00	10,00	AW/BS LD	FPM	82528	gearbox	DAF	0609 475	033464	12013757	
114767	85,00	105,00	10,00	AW/BS LD	FPM	82528	gearbox	DAF	0693 928	033464	12013757	
46983	85,00	105,00	10,00	B	NBR	50341	gearbox	DB	004 997 0646	556807	12011340	81-25546-00
47536	85,00	105,00	10,00	B LD	FPM	4047	gearbox	DB	004 997 0647	033464	12013757	
46989	85,00	105,00	10,00	B LD	FPM	4047	gearbox	DB	004 997 2246	033464	12013757	
47597	85,00	105,00	10,00	B LD	FPM	4047	gearbox	DB	006 997 4147	033464		
4048	85,00	105,00	10,00	B LD	FPM	4047	gearbox	DB	006 997 7046	033464		
47605	85,00	105,00	10,00	B LD	FPM	4047	gearbox	DB	006 997 8647	033464		
36791	85,00	105,00	10,00	B LD	FPM	4047	gearbox	DB	007 997 5947	033464	12013757	
47648	85,00	105,00	10,00	B LD	FPM	4047	gearbox	DB	008 997 3347	033464	12013757	
51744	85,00	105,00	10,00	B LD	FPM	4047	gearbox	DB	009 997 5947		12013757	
4646	85,00	105,00	10,00	B LD	FPM	4047	gearbox	DB	012 997 0647	033464	12013757	
112542	85,00	105,00	10,00	B LD	FPM	4047	gearbox	IVECO	4248 5827	033464	12013757	
114768	85,00	105,00	10,00	AW/BS LD	FPM	82528	gearbox	MAN	06 56289 0067	033464	12013757	
35690	85,00	105,00	10,00	B blue	NBR	50341	gearbox	MAN	06 56289 0132	556807	12011340	
35210	85,00	105,00	10,00	B blue	NBR	50341	gearbox	MAN	81 96501 0446	556807	12011340	
114769	85,00	105,00	10,00	AW/BS LD	FPM	82528	gearbox	MAN	81 96501 0966		12013757	
50681	85,00	105,00	10,00	B LD	FPM	4047	gearbox	MAN	81 96502 0208	033464	12013757	
82737	85,00	105,00	10,00	B	NBR	50341	gearbox	MAN	81 96502 0247	556807		

Dimensions

Dimensions

dph-no	dim 1	dim 2	dim 3	Style	Material	dph oil seal no.	Application	Type	OEM-NO	Elring	Corteco	Reinz
81738	85,00	105,00	10,00	CS	NBR	70803	crankshaft	STEYR	90 003 078 775			
95875	85,00	105,00	10,00	B LD	FPM	4047	gearbox	VOLVO	1 190 064			81-35297-00
111794	85,00	105,00	10,00	B	NBR	50341	gearbox	ZF	0634 300 712		12011340	
95876	85,00	105,00	10,00	B LD	FPM	4047	gearbox	ZF	0734 310 109		12013757	
82330	85,00	105,00	10,00	B LD	FPM	4047	gearbox	ZF	0750 111 004		01011312	
96323	85,00	105,00	11,00	AS W LD	MVQ	96323	crankshaft	PEUGEOT	0514 40			
70819	85,00	105,00	11,00	AS W LD	FPM	84358	crankshaft	VW	026 103 051 A			
81598	85,00	105,00	11,00	M6 SP KA	PTFE	109159	crankshaft	VW	028 103 171		20033462	
96899	85,00	105,00	11,00	M6 SP KA	PTFE	109159	crankshaft	VW	028 103 171 B	804850	20033462	
69585	85,00	105,00	11,00	AS W LD	FPM	84358	crankshaft	VW	068 103 051 G		12015256	81-35353-00
96323	85,00	105,00	11,00	AS W LD	MVQ	96323	crankshaft	VW	068 103 051 G			
37152	85,00	105,00	11,00	M7 SP KA	PTFE	81520	crankshaft	VW	068 103 171 G-F	804850	20033462	
95849	85,00	105,00	11,00	M7 SP KA	PTFE	81520	crankshaft	VW	06A 103 171 A/B			
46984	85,00	105,00	12,00	B	NBR	44329		DB	004 997 0746		12011359	
51884	85,00	105,00	12,00	C	NBR	51710	crankshaft	MAN	06 56289 0181		01017033	
59263	85,00	105,00	12,00	AS W LD	FPM/ACM	114899	crankshaft	PEUGEOT	0514 40	315494	12012347	
4277	85,00	105,00	12,00	A/BS LD W	FPM	61492	crankshaft	VOLVO PC	1 257 049	342092	12012347	
61492	85,00	105,00	12,00	A/BS LD W	FPM	61492	crankshaft	VOLVO PC	3 287 542	342092	12012347	81-36788-00
61492	85,00	105,00	12,00	A/BS LD W	FPM	61492	crankshaft	VW	026 103 051 A		12015256	
111184	85,00	105,00	12,00	AS W LD	FPM/ACM	114899	crankshaft	VW	049 103 051 D	315494		
22982	85,00	105,00	12,00	A/BS LD W	FPM	61492	crankshaft	VW	056 103 051 D		12012347	
35634	85,00	105,00	12,00	A/BS LD W	FPM	61492	crankshaft	VW	056 103 051G			
34632	85,00	105,00	12,00	A/BS LD W	FPM	61492	crankshaft	VW	068 103 051			
82328	85,00	105,00	12,00	B	NBR	44329	gearbox	ZF	0750 110 074		12011341	
47607	85,00	105,00	12,00	B	NBR	44329	gearbox	DB	006 997 8847	033480		
47719	85,00	105,00	12,00	B	NBR	44329	gearbox	DB	011 997 8547	033480	12011341	81-35091-00
114770	85,00	105,00	13,00	BS	NBR	32425	gearbox	DAF	0578 507		12011359	
47282	85,00	105,00	13,00	BS	NBR	32425	gearbox	DB	007 997 9946	096067	12011359	81-35092-00
47283	85,00	105,00	13,00	B WD	FPM	36789	rear axle	DB	008 997 0046	008680		81-35089-00
6550	85,00	105,00	13,00	BS blue	NBR	32425	gearbox	DB	009 997 1146	096067	12011359	
47322	85,00	105,00	13,00	B WD	FPM	36789	rear axle	DB	009 997 1246	008680		81-35089-00
36790	85,00	105,00	13,00	B WD	FPM	36789	rear axle	DB	010 997 3646	008680	12012549	81-35089-00
47363	85,00	105,00	13,00	B WD	FPM	36789	rear axle	DB	010 997 5446	008680	12012549	
47394	85,00	105,00	13,00	BS	NBR	32425	gearbox	DB	011 997 4246	096067		81-35092-00
35147	85,00	105,00	13,00	BS blue	NBR	32425	differential	MAN	06 56289 0033	096067	12011359	81-35092-00

dph-no	dim 1	dim 2	dim 3	Style	Material	dph oil seal no.	Application	Type	OEM-NO	Elring	Corteco	Reinz
33421	85,00	105,00	13,00	B WD	FPM	36789	differential	MAN	06 56289 0047	008680		
68551	85,00	105,00	13,00	B WD	FPM	36789	rear axle	MAN	06 56289 0048	008680	12012549	81-35089-00
68541	85,00	105,00	13,00	BS	NBR	32425	gearbox	MAN	06 56289 0167	096067	12011359	
70525	85,00	105,00	13,00	BS	NBR	32425	differential	SCANIA	386 901	096067		
114771	85,00	105,00	13,00	BS	NBR	32425	differential	ZF	0634 309 106		12011359	
111372	85,00	105,00	18,00	FPM	SP LD	111372	front axle	SCANIA	1 393 331			
111581	85,00	105,00	12/10	B	NBR	95872	gearbox	DAF	0585 373	033480	12011341	81-35091-00
95873	85,00	105,00	12/10	B	NBR	95872	gearbox	VOLVO	1 139 840			
95874	85,00	105,00	12/10	B	NBR	95872	gearbox	ZF	0734 300 093		12011341	
115353	85,00	105,00	11/6,8	AS LD	FPM	115352	crankshaft	RENAULT	77 03 087 224	711720	20018246	81-34417-00
117306	85,00	105,00	13/9,5	A/BS	NBR	93553	differential	MAN	06 56289 0361		01029595	
93555	85,00	105,00	9,5/13	A/BS	NBR	93553	differential	DB	017 997 2847	198430	01029595	
93556	85,00	105,00	9,5/13	A/B WD	FPM	93554	differential	DB	017 997 2947	198440	01029594	
117301	85,00	105,00	9,5/13	A/B WD	FPM	93554	differential	MAN	06 56289 0357		01029594	
111757	85,00	110,00	6,00	BS OF SF	NBR	111756	differential	RVI	0024 472 624		01026300	
93700	85,00	110,00	12,00	BS	NBR	42696	crankshaft	IVECO	247 7868		12011360	
111641	85,00	110,00	12,00	A/CS W WD	ACM	83908	wheel hub	IVECO	4010 0470		12014599	
83909	85,00	110,00	12,00	A/CS W WD	ACM	83908	wheel hub	IVECO	4010 0473			
114497	85,00	110,00	12,00	AW/BS RD	FPM	114429	differential	RVI	5010 319 134		01020413	
111755	85,00	110,00	12,00	AW/BS LD	FPM	111813		RVI	5010 319 135		01026331	
46958	85,00	110,00	13,00	A	NBR	19167		DB	003 997 3146			
113943	85,00	110,00	13,00	AS	NBR	18731	wheel hub	RVI	5000 788 400	300896		
113936	85,00	110,00	13,00	A	NBR	19167	wheel hub	RVI	7701 003 394		12013388	
119104	85,00	110,00	14,00	A/CS WD W	FPM	81350	crankshaft	IVECO	4010 2050		12015544	
83900	85,00	110,00	14,00	A/CS WD W	FPM	81350	crankshaft	IVECO	4010 2053		12015544	
114773	85,00	110,00	10/14	A/B Duo	FPM	114400	crankshaft	MAN	06 56289 0329		01029919	
114916	85,00	110,00	10/14	A/B Duo	FPM	114400	crankshaft	ZF	0734 319 460		01029919	
114772	85,00	110,00	12/16	AW/BS RD	FPM	114399	differential	DAF	0538 953			
117052	85,00	110,00	12/17	AW/BS	FPM	117051	differential	DB	014 997 1246	504560	01033971	
117053	85,00	110,00	12/17	AW/BS	FPM	119376	crankshaft	MAN	06 56289 0394		01033971	
15302	85,00	110,00	13/15,00	AS RD green	MVQ	15301		MAN	51 01510 0077			
84615	85,00	110,00	13/9,5	A	NBR	81336	front axle	DAF	0015 484		12013388	
109158	85,00	110,00	13/9,5	A	NBR	81336	front axle	DAF	0015 485		12013388	
108798	85,00	110,00	13/9,5	A	NBR	81336	wheel accessory kit	VOLVO	947 270-5	300896	12013388	
110002	85,00	125,00	12,00	SP	FPM	110004	differential	DAF	0077 479		01016687	

Dimensions

Dimensions

dph-no	dim 1	dim 2	dim 3	Style	Material	dph oil seal no.	Application	Type	OEM-NO	Eling	Corteco	Reinz
113580	85,00	130	17/26	AS RD W SP	FPM/ACM	113571	crankshaft	RVI	5000 675 975		07016736	
113572	85,00	130	17/26	AS RD W SP	FPM/ACM	113571	crankshaft	RVI	5010 534 001		07016736	
113579	85,00	130	17/26	AS RD W SP	FPM/ACM	113571	crankshaft	RVI	5010 534 863		07016736	
114774	85,00	130,00	17/26	AS RD W SP	FPM/ACM	113571	crankshaft	VOLVO	3 152 027		07016736	
111374	85,00	140,00	13/17	BS SP	FPM	111387	differential	DAF	1287 102		01027965	
117702	85,00	140,00	13/17	BS SP	FPM	111387	differential	DAF	1739 947			
114775	85,00	140,00	15/16,5	KA	FPM/NBR	114401	differential	DAF	0376 992		01017057	
112249	85,00	145,00	12/32	SP	FPM	114402	differential	DB	018 997 1847	065510	01030110	
95475	85,00	145,00	12/37	SP SP	FPM	95864	differential	DB	015 997 4747	447080	01017059	
114776	85,00	145,00	12/37	SP	FPM	95864	differential	MAN	06 56289 0319	447080	01017059	
119244	85,00	150,00	16,35/20	KA/BS SP	FPM/ACM	118628	axle transmission	MAN	81 96503 0442			
118410	85,00	150,00	16,35/20	KA/BS SP	FPM/ACM	118628	axle transmission	MAN	81 96503 0443			
115480	85,00	155,00	12/33	SP	FPM	114403	differential	DB	021 997 8547	220660	01027938	
110504	85,00	131/152	15,70	KA	PTFE	120201	crankshaft	VW	06A 103 171 B / D	012370	20020383	81-90010-00
114464	85,00	150/169,00	12/31,5	BS RD SP	FPM	114404	crankshaft	MAN	06 56289 0266		01019881	
37211	85,73	114,33	13/9,5	A/BS RD W	FPM	81284	crankshaft	VOLVO	424 983-5	570495	12013988	81-25952-20
81284	85,73	114,33	13/9,5	A/BS RD W	FPM	81284	crankshaft	VOLVO	469 507-8		12013988	
110473	85,73	114,45	14,29	AS W RD	MVQ	15250	crankshaft	VOLVO	424 983-5			
15253	85,73	114,45	14,29	AS W RD	MVQ	15250	crankshaft	VOLVO	469 507-8			
51453	86,00	104,00	11,00	AS W LD	FPM	51452	crankshaft	OPEL	614 817	581879	12010749	81-25517-00
109594	86,00	105,00	5/6	AS SP W	NBR	109593	wheel hub	DB	021 997 8947		12016794	
96434	87,00	100,00	8,50	AS LD	FPM	97874	crankshaft	OPEL	614 825	060110	12015429	81-53299-00
70269	87,17	117,47	11,90	SP	NBR	118913		VOLVO	191 160-1			
113846	87,26	120,76	15,40	KA SP	FPM/ACM	113845	crankshaft	MAN	81 96503 0161		12020256	
96929	88,00	105,00	13,00	CS	NBR	96928	wheel hub	Toyota	90311-88102		19018295	
96239	88,00	108,00	11,10	AW/BS LD	MVQ	80679	crankshaft	FORD	1 614 996		15011269	
109036	88,00	108,00	11,10	AW/BS LD	FPM	80639	crankshaft	FORD	1 663 815		15510078	
81087	88,00	108,00	11,10	AW BS LD	MVQ	80679	crankshaft	FORD	6 126 179	750476	15011269	
80639	88,00	108,00	11,10	AW/BS LD	FPM	80639	crankshaft	FORD	6 126 179			81-25452-10
80631	88,00	108,00	11,10	AW/BS LD	FPM	80639	crankshaft	FORD	6 165 502	750476	12014402	
80679	88,00	108,00	11,10	AW/BS LD	MVQ	80679	crankshaft	FORD	6 165 502			
109704	88,00	108,00	11,10	AW/BS LD	FPM	80639	crankshaft	SAAB	91 74 202		12014402	
109703	88,00	108,00	11,10	AW/BS LD	FPM	80639	crankshaft	SAAB	91 75 902	330959		81-25452-10
37649	88,00	108,00	12,00	AS LD W	NBR	37653	crankshaft	SAAB	93 50 158			
51454	90,00	104,00	11,00	A/BS LD	FPM	93733	crankshaft	OPEL	614 819	694770	12014523	81-27294-10

dph-no	dim 1	dim 2	dim 3	Style	Material	dph oil seal no.	Application	Type	OEM-NO	Eling	Corteco	Reinz
50824	90,00	104,00	11,00	A/BS LD	MVQ	50824	crankshaft	OPEL	614 827			
50704	90,00	104,00	11,00	A/BS LD	FPM	93733	crankshaft	OPEL	614 827	694770		81-27294-10
50824	90,00	104,00	11,00	A/BS LD	MVQ	50824	crankshaft	OPEL	614 829			
59233	90,00	104,00	11,00	A/BS LD	FPM	93733	crankshaft	OPEL	614 829	694770	12014523	81-27294-10
96360	90,00	104,00	11,00	A/BS LD	FPM	93733	crankshaft	OPEL	614 840	694770	20033412	
82474	90,00	110,00	7,00	AS W LD	FPM	82473	crankshaft	PEUGEOT	0119 06			81-34456-00
84463	90,00	110,00	7,00	AS W LD	FPM	82473	crankshaft	PEUGEOT	0127 28			81-34456-00
117108	90,00	110,00	7,00	AS W LD	FPM/ACM	117108	crankshaft	PEUGEOT	0127 28	508209	20015455	81-25925-00
47469	90,00	110,00	8,00	B	NBR	47993		DB	001 997 1747			
47624	90,00	110,00	8,00	B	NBR	47993		DB	007 997 5747			
47634	90,00	110,00	8,00	B	NBR	47993		DB	007 997 9047			
94630	90,00	110,00	8,00	B	NBR	18752		ZF	0750 110 069			
47467	90,00	110,00	10,00	B	FPM	47468		DB	001 997 1647			
47535	90,00	110,00	10,00	B	FPM	47468		DB	004 997 0047			
47625	90,00	110,00	10,00	BS	MVQ	81539		DB	007 997 5847			
80856	90,00	110,00	10,00	A SP	NBR	36835	crankshaft	MAN	06 56289 0321		01020678	
118512	90,00	110,00	10,00	AS W LD	FPM/ACM	118512	crankshaft	PEUGEOT	0119 06	294683	12010750	
119409	90,00	110,00	11,00	AS W RD	PTFE/ACM	119416	crankshaft	RENAULT	50 10 359 806	453930	15026914	81-37914-00
109060	90,00	110,00	12,00	AW/BS LD	FPM	15246	crankshaft	BMW	11 14 1 255 012		12012579	
84171	90,00	110,00	12,00	AW/BS LD	FPM	15246	crankshaft	BMW	11 14 1 275 161		12012579	
48086	90,00	110,00	12,00	AW/BS LD	FPM	15246	crankshaft	BMW	11 14 1 706 785	702994	12012579	81-20745-40
15256	90,00	110,00	12,00	AW/BS LD	FPM	15246	crankshaft	BMW	11 14 1 706 999		12012579	
109120	90,00	110,00	12,00	AW/BS LD	FPM	15246	crankshaft	BMW	11 14 2 245 364	702994	12012579	81-20745-40
114778	90,00	110,00	12,00	AS WD combi	PTFE/AEM	114405	crankshaft	BMW	11 14 2 247 164		20019546	
114777	90,00	110,00	12,00	AW/BS LD	FPM	15246	crankshaft	DEUTZ	1215 2257		12012579	
114779	90,00	110,00	12,00	AS WD combi	PTFE/AEM	114405	crankshaft	OPEL	614 802		20019546	81-20745-50
110581	90,00	110,00	12,00	AS W LD	PTFE/AEM	114405	crankshaft	OPEL	614 838		20019546	
15246	90,00	110,00	12,00	AW/BS LD	FPM	15246	crankshaft	OPEL	614 838	702994		
97331	90,00	110,00	12,00	AW/BS LD	FPM	15246	crankshaft	PORSCHE	999 113 26440		12012579	
111401	90,00	110,00	12,00	AW/BS LD	FPM	15246	crankshaft	PORSCHE	999 113 42641		12012579	
119068	90,00	110,00	12,00	A	NBR	50350		RVI	50 0000 0813		12011043	
47674	90,00	110,00	13,00	A/BS	NBR	48024	rear axle	DB	010 997 0147	567779	12015249	
47680	90,00	110,00	13,00	A/BS	NBR	48024	rear axle	DB	010 997 5347	567779	12015249	
47696	90,00	110,00	13,00	A/BS	NBR	48024	rear axle	DB	010 997 8647	567779	12015249	
111642	90,00	110,00	13,00	CS	NBR	18763	rear axle	IVECO	4000 1900		12011412	

Dimensions

Dimensions

dph-no	dim 1	dim 2	dim 3	Style	Material	dph oil seal no.	Application	Type	OEM-NO	Eling	Corteco	Reinz
113666	90,00	110,00	13,00	AS W	FPM	113665	crankshaft	MAN	06 56289 0183	514950	20016781	
34425	90,00	110,00	14,00	BS	NBR	81437	differential	SCANIA	214 008		12002888	
80868	90,00	110,00	15,00	BS RD LA	MVQ	61099	crankshaft	DEUTZ	241 6507			
94728	90,00	110,00	15,00	BS RD LA	FPM	94728	crankshaft	DEUTZ	241 6507	331198		81-22593-20
96083	90,00	110,00	15,00	BS RD LA	FPM	94728	crankshaft	MAN	06 56289 0139			
97376	90,00	110,00	15,00	AW/BD	FPM	96082	crankshaft	ZF	0734 300 046			
97375	90,00	110,00	15,00	AW/BD	FPM	96082	gearbox	ZF	0734 310 121			
117331	90,00	110,00	15,00	AW BD	FPM	96082		MAN	81 96502 0699	762830		
111744	90,00	110,00	15,50	A/BS WD	FPM	111743	transfer gearbox	DB	015 997 6947		01030122	
94048	90,00	110,00	11/9,5	AW/BS LD	FPM	94047	crankshaft	VOLVO	1 669 618		01026642	
115629	90,00	112,66	13/9,6	A/BS	NBR	115628		DB	017 997 0147			
46951	90,00	112,70	13,00	C	NBR	50803	rear axle	DB	002 997 6846	044571	12011397	81-33850-00
94988	90,00	112,70	13,00	C	NBR	50803	rear axle	DB	003 997 6846		12011397	
98269	90,00	115,00	13,00	AS LD	MVQ	98270	crankshaft	FIAT	4010 0311			81-33624-00
93846	90,00	115,00	13,00	A/BS LD W	FPM	81347	crankshaft	IVECO	4000 2631			
119099	90,00	115,00	13,00	A/BS LD W	FPM	81347	crankshaft	IVECO	4010 0310		12011304	
81570	90,00	115,00	13,00	A/BS LD W	FPM	81347	crankshaft	IVECO	4010 0313		12011304	
119408	90,00	120,00	11,00	AS W RD	PTFE	119415	crankshaft	RENAULT	50 10 861 755			
34671	90,00	120,00	13,00	C green	NBR	51722	rear axle	DB	006 997 0446	042617	12011413	81-35149-00
115631	90,00	120,00	12/11	A/BS blue	NBR	115630		DB	019 997 5747			
96428	90,00	120,00	12/9,5	BS RD	FPM	94933	gearbox	ZF	0734 319 127		01026464	
109722	90,00	120,00	13/9,5	A/BS WD	FPM	109726	crankshaft	ZF	0750 111 116		01029767	
120052	90,00	125,00	12,00	AS W LD	FPM	120051	gearbox	DB	018 997 8648		20034608	
120053	90,00	125,00	12,00	AS W LD	FPM	120051	gearbox	VOLVO	1 662 026		20034608	
120054	90,00	125,00	12,00	AS W LD	FPM	120051	gearbox	ZF	0734 319 052		20034608	
69291	90,00	125,25	10,00	BS RD LA	FPM	69290	rear axle	VOLVO	948 642-8	587991	12014746	81-35142-00
116554	90,00	130,00	17,00	KA	NBR	113051		DAF	1404 690		19034570	
114317	90,00	140,00	15,5/20	KA	FPM	114316	crankshaft	DAF	1278 421		01015529	
112427	90,00	145,00	10,00	A/BS LD	FPM	112716	automatic gearbox	VOLVO	1 652 776	435340	12016675	81-35136-00
95354	90,00	145,00	10/15	A/B SP	FPM	94049	differential	VOLVO	1 523 239	435180	12015693	81-35132-00
115687	90,00	145,00	10/15	A/B SP	FPM	94049	differential	VOLVO	1 673 701	435180	01034125	
112428	90,00	151,00	11/17	BS2 LA RD SP	FPM	119116	differential	VOLVO	1 523 634			
112986	90,00	151,00	11/17	BS2 LA RD SP	FPM	119116	differential	VOLVO	3 192 069			
112983	90,00	151,00	11/14,5	A/BS RD SP	FPM	119114	differential	VOLVO	3 192 615			
115418	91,00	111,00	10,00	A/BS LD	FPM	115433		BMW	11 11 1 492 244			

dph-no	dim 1	dim 2	dim 3	Style	Material	dph oil seal no.	Application	Type	OEM-NO	Eling	Corteco	Reinz
114780	91,00	121,00	12,00	SP	PTFE	114406	crankshaft	CUMMINS	3004317			
48261	91,00		8,00		graph.		crankshaft	DB	000 997 9641	101577		
4292	92,00	110,00	7,00	AS LD W	FPM	49103	crankshaft	VOLVO PC	6 842 093-4	044590	12017124	
35613	92,00	110,00	10,00	AW LD	MVQ	16051	crankshaft	VOLVO PC	1 266 604		12013897	
33548	92,00	110,00	10,00	AS LD W	MVQ	16051	crankshaft	VOLVO PC	430 118-0	044598	12013897	81-25583-00
114781	93,00	114,00	11,50	AS W LD	PTFE	113679	crankshaft	DB	112 997 0046	524215	20031906	81-37439-00
113678	93,00	114,00	11,50	AS W LD SP	PTFE	113679	crankshaft	DB	112 997 0246		20031906	
114811	93,00	114,00	11,50	AS W LD	PTFE	113679	crankshaft	DB	112 997 0446			
109057	93,00	114,00	14,00	AS W LD	FPM	48028	crankshaft	DB	009 997 9047			
36226	93,00	114,00	14,00	AS W LD	FPM	48028	crankshaft	DB	010 997 9047		12012249	
47703	93,00	114,00	14,00	AS W LD	FPM	48028	crankshaft	DB	011 997 0647			
80452	93,00	114,00	14,00	AS W LD	FPM	48028	crankshaft	DB	017 997 7447			
47644	93,00	117,00	12,00	BS LD LA	FPM	6648	crankshaft	DB	008 997 2547	344230		
15262	93,00	117,00	12,00	BS LD LA	FPM	6648	crankshaft	DB	008 997 2647	344230	12012246	81-25242-00
47663	93,00	117,00	12,00	BS LD LA	FPM	6648	crankshaft	DB	009 997 3647	344230		
36224	93,00	117,00	12,00	BS LD LA	FPM	6648	crankshaft	DB	010 997 8247	344230	12012246	81-25242-00
110503	93,00	155,00	15,50	KA	PTFE	114782	crankshaft	DB	611 010 0114	746400	20030144	81-90002-00
113958	95,00	110,00	10,00	B WD blue	NBR	113957	wheel hub	RVI	5000 545 227		07013389	
117406	95,00	110,00	10	B WD	NBR	113957	wheel hub	IVECO	8601 4686		07013389	
119891	95,00	110,00	10	B WD	NBR	113957	wheel hub	VOLVO	947 271-3		07013389	
114484	95,00	114,00	14,00	C WD	ACM	114439	wheel hub	IVECO	4010 0093		12001579	
81132	95,00	115,00	12,00	AS W RD	MVQ	81130	crankshaft	STEYR	90 003 078 807			
47676	95,00	115,00	13,00	A/BS blue	NBR	48025	wheel hub	DB	010 997 2447	567795	12015263	81-35094-00
47681	95,00	115,00	13,00	A/BS blue	NBR	48025	wheel hub	DB	010 997 5447	567795		81-35094-00
47697	95,00	115,00	13,00	A/BS blue	NBR	48025	wheel hub	DB	010 997 8747	567795	12015263	
114610	95,00	115,00	13,00	AW/BS WD	FPM	114407	wheel hub	DB	021 997 0047		01029660	
82278	95,00	115,00	13,00	CS	NBR	81441		MAN	06 56289 0215			
114611	95,00	115,00	15,50	A/BS LD	FPM	114408	gearbox	DB	023 997 1647	222830	01029684	
93238	95,00	115,00	13/12	BS	NBR	93237		DB	013 997 7247		01002889	
81121	95,00	115,00	13/12	A/B LD	FPM	93240	gearbox shaft	DB	013 997 7347	141950	01017136	
114609	95,00	115,00	13/12	A/B LD	FPM	93240	gearbox shaft	DB	015 997 4247		01017136	
82967	95,00	115,00	10/9,5	A/B	NBR	82966	crankshaft	MAN	06 56289 0322		01018219	
114608	95,00	115,00	10/9,5	A/B	NBR	82966	crankshaft	MAN	06 56289 0325		01018219	
111512	95,00	116,50	11,00	SP	FPM	113829	wheel hub	MAN	81 52403 6005	473310		
113830	95,00	116,50	11,00	SP 1 combi	FPM	113832	wheel hub	MAN	81 52403 6006			

Dimensions

Dimensions

dph-no	dim 1	dim 2	dim 3	Style	Material	dph oil seal no.	Application	Type	OEM-NO	Eling	Corteco	Reinz
113671	95,00	120,00	10,00	A/B	NBR	113670	crankshaft	MAN	06 56289 0323		01018243	
47485	95,00	120,00	12,00	A	NBR	18798	crankshaft	DB	002 997 0747		12011047	
80389	95,00	120,00	12,00	AS RD	ACM	68547	crankshaft	DEUTZ	116 3316	042676		81-22228-00
47241	95,00	120,00	13,00	C	NBR	51723	rear axle	DB	006 997 6946	042684	12011398	81-35093-00
47341	95,00	120,00	13,00	C	NBR	51723	rear axle	DB	009 997 7646			
47672	95,00	120,00	13,00	A/BS	NBR	48026	wheel hub	DB	009 997 9247	567787	12015264	
47682	95,00	120,00	13,00	A/BS	NBR	48026	wheel hub	DB	010 997 5547	567787	12015264	
47698	95,00	120,00	13,00	A/BS	NBR	48026	wheel hub	DB	010 997 8847	567787	12015264	
47722	95,00	120,00	13,00	A/BS	NBR	48026	wheel hub	DB	012 997 1147	567787	12015264	
114612	95,00	120,00	13,00	BS LD	FPM	82399	crankshaft	IVECO	4000 0720	071570	12011314	
114613	95,00	120,00	13,00	C	NBR	51723	rear axle	MAN	06 56289 0111	042684	12011398	81-35093-00
114614	95,00	120,00	13,00	C	NBR	51723	rear axle	MAN	06 56289 0273		12011398	
116997	95,00	120,00	13,00	BS LD	FPM	82399	crankshaft	RVI	5010 242 655		12015304	
82339	95,00	120,00	13/12	AW/BS RD F	FPM	82338		DEUTZ	414 6007		01016938	
114615	95,00	120,50	12,50	SP	PTFE	114409		CUMMINS	3010459			
46876	95,00	125,00	13,00	CS	NBR	82785	front axle	DB	000 997 3446	042714	12011399	
47451	95,00	125,00	13,00	CS	NBR	82785	rear axle	DB	000 997 6747			
47521	95,00	130,00	13,00	C	NBR	18810	front axle	DB	003 997 4047	042714	12011399	
119105	95,00	130,00	16,00	KA SP	FPM/ACM	93221	crankshaft	IVECO	4010 2140		12015509	
82965	95,00	130,00	16,00	KA SP	FPM/ACM	93221	crankshaft	IVECO	4010 2143	454000	12015509	
84267	95,00	130,00	12/13	AW/BS RD F	FPM	82797	crankshaft	DEUTZ	414 2503	830879	01016936	81-26022-00
114616	95,30	114,29	11,88	BS WD LA	FPM	96979	gearbox	DAF	0696 084		12012235	
96979	95,30	114,29	11,88	BS WD LA	FPM	96979	gearbox	FULLER	K2256			
110730	95,30	114,29	11,88	BS WD LA	FPM	96979	crankshaft	IVECO	190 5085		12012235	
114617	95,30	114,29	11,88	BS WD LA	FPM	96979	gearbox	IVECO	4249 0447		12012235	
110735	95,30	114,29	11,88	BS WD LA	FPM	96979	gearbox	IVECO	798 0661		12012235	
114618	95,30	114,29	11,88	BS WD LA	FPM	96979	crankshaft	MAN	81 96502 0451		12012235	
117252	95,30	114,29	11,88	BS WD LA	FPM	96979	gearbox	RVI	5000 814 109		12012235	
115406	97,00	110,00	8,00	A LD felt	FPM	113718	crankshaft	VOLVO PC	6 842 274	135190		
95574	97,00	110,00	8,00	A LD felt	FPM	113718	crankshaft	VOLVO PC	9 458 178	135190	15510087	
80413	98,00	110,70	6,80	AS W	MVQ	80413		VOLVO				
114511	98,00	115,00	6,5/13	AS W SP	NBR	114454	crankshaft	RVI	5000 804 940			
111550	99,00	114,00	8,00	A	FPM/ACM	112394	crankshaft	OPEL	614 855			
111456	100,00	113,60	6,50		NBR	111456	wheel accessory kit	VOLVO	1 076 656-6			
111780	100,00	118,00	10,00	A/BS LD	FPM	111779	crankshaft	FIAT	4010 0340		12014831	

dph-no	dim 1	dim 2	dim 3	Style	Material	dph oil seal no.	Application	Type	OEM-NO	Eling	Corteco	Reinz
98531	100,00	118,00	12,00	A/BS LD	MVQ	98532	crankshaft	FIAT	4010 0341			81-33858-00
47499	100,00	120,00	10,00	A W LD	FPM	48007	transmission	DB	002 997 5947			
47553	100,00	120,00	10,00	A W LD	FPM	48007	transmission	DB	004 997 7047			
47661	100,00	120,00	10,00	A W LD	FPM	48007	transmission	DB	009 997 2447		12013550	
117407	100,00	120,00	10,00	BS SF	NBR	111681	crankshaft	IVECO	4000 0760		12011363	
114619	100,00	120,00	10,00	A W LD	FPM	48007		ZF	0734 310 131		12013550	
118373	100,00	120,00	12,00	AS	NBR	19863	crankshaft	DAF	1 602 361		12011209	
113941	100,00	120,00	12,00	AS W WD	NBR	111803	wheel hub	RVI	0024 472 286		07016683	
94318	100,00	120,00	12,00	A/BS WD	FPM	95865	crankshaft	VOLVO	1 070 379		12017395	
82324	100,00	120,00	12,00	AS	NBR	19863	wheel accessory kit	VOLVO	968 012-5		12011209	
47260	100,00	120,00	13,00	C	NBR	18825	front axle	DB	007 997 3646	592609	12011400	81-35097-00
47716	100,00	120,00	13,00	C	NBR	18825	front axle	DB	011 997 7147	562609	12011400	
93641	100,00	120,00	15,00	AW/BS RD	FPM	82047	crankshaft	DEUTZ	214 8905		12012580	
70548	100,00	120,00	15,00	AW/BS RD F	FPM	82047	crankshaft	DEUTZ	242 1819	756121	12012580	81-25986-20
61100	100,00	120,00	15,00	BS RD LA	MVQ	61100	crankshaft	DEUTZ	242 1819			
81765	100,00	120,00	13/10	C	NBR	50801	front axle	DB	345 997 8446			
110697	100,00	120,00	13/10	C	NBR	50801	wheel hub	MAN	06 56289 0207			
114493	100,00	120,00	10/9,5	AS2 W WD	FPM	114437	wheel hub	RVI	5000 807 810		01035692	
109784	100,00	120,00	11/16,5	BS SP	NBR	109788	wheel hub	DB	022 997 3447	477860	01030116	
81766	100,00	123,80	13,00	C	NBR	80662		DB	006 997 9846			
104116	100,00	124,00	12,00	AS RD	FPM	95198	crankshaft	DAF	1275 084			81-29052-00
114620	100,00	124,00	12,00	AS RD SP	PTFE/ACM	114410	crankshaft	DAF	1340 321	493330	15027586	81-29052-10
82348	100,00	124,00	13,00	AW/BS LD F	FPM	82347	crankshaft	DAF	0281 986		12015531	
47586	100,00	124,00	13,00	BS LA LD	FPM	48019	crankshaft	DB	005 997 8347			
61393	100,00	124,00	13,00	BS LA LD	FPM	48019	crankshaft	DB	116 997 0246	762172	01029678	81-25268-10
80225	100,00	124,00	15,00	AS LD	MVQ	80224		DB	010 997 7046			
81585	100,00	124,00	10,5/12,5	AS W LD	MVQ	81587	crankshaft	DB	001 997 8747 FE	247189		81-22887-00
112638	100,00	125,00	13,00	A/B LD	FPM	112637	crankshaft back	BMW	11 14 1 710 247	818399	20026342	
114622	100,00	125,00	13,00	A/B LD	FPM	112637	crankshaft back	BMW	11 14 1 713 730	818399	20026342	81-27373-00
47717	100,00	125,00	13,00	A/BS	NBR	48030	front axle	DB	011 997 7247	562874	12015406	
47728	100,00	125,00	13,00	A/BS	NBR	48030	front axle	DB	012 997 9147	562874	12015406	
111759	100,00	125,00	13,00	AS W WD	NBR	111758	crankshaft	RVI	5010 067 534		12014731	
116222	100,00	125,00	13,00	BS LA RD	FPM	95927	crankshaft	STEYR	90 003 074 478			
109444	100,00	125,00	13,00	AS W RD	FPM	109443	crankshaft	STEYR	90 003 078 831			
47247	100,00	125,00	13,00	C	NBR	18829	rear axle	DB	006 997 9346		12011401	81-35096-00

Dimensions

Dimensions

dph-no	dim 1	dim 2	dim 3	Style	Material	dph oil seal no.	Application	Type	OEM-NO	Elring	Corteco	Reinz
47245	100,00	125,00	13/10	C	NBR	50810	rear axle	DB	006 997 8346			
114621	100,00	125,00	13/10	C	NBR	50810	rear axle	MAN	06 56289 0009		12011401	81-35096-00
116368	100,00	130,00	11,00	AW/BS RD	PTFE/ACM	117451	crankshaft	DB	013 997 1646		20034028	
117452	100,00	130,00	11,00	AW/BS RD	PTFE/ACM	117451	crankshaft	DB	025 997 3947	369901	20034028	
114624	100,00	130,00	12,00	AW/BS RD	PTFE/ACM	114411	crankshaft	DB	021 997 5247	369900	20029784	
114623	100,00	130,00	12,00	A/CS WD W	ACM	81353	crankshaft	IVECO	4010 0460		12014422	
117408	100,00	130,00	12,00	A/CS WD W	ACM	81353	crankshaft	IVECO	4010 0463		12014422	
81610	100,00	130,00	12,00	A	NBR	18831	crankshaft	MAN	06 56289 0315	519243	01018440	
37845	100,00	130,00	12,00	A	NBR	18831	crankshaft	MAN	06 56289 0324		01018440	
109684	100,00	130,00	12,00	A/B	FPM	109686	wheel hub	MAN	06 56289 0369	374360	01020679	
112555	100,00	130,00	12,00	AW/BS RD	PTFE	114411	crankshaft	MAN	51 01510 0236		20031177	
114625	100,00	130,00	12,00	AW/BS RD	PTFE/ACM	114411	crankshaft	MAN	51 01510 0273	158510	20031177	
114498	100,00	130,00	12,50	AW/BS SP	FPM	114441	wheel hub	RVI	5010 443 187		12033886	
46760	100,00	130,00	13,00	AW/BS	NBR	61447	front-/rear axle	DB	009 997 6747	232459	12000552	81-33861-00
36647	100,00	130,00	13,00	AS	NBR	4377	front & rear axle	DB	010 997 9046	814172	12000552	
47373	100,00	130,00	13,00	AS	NBR	36648		DB	010 997 9146			
47388	100,00	130,00	13,00	AS	NBR	4377	front & rear axle	DB	011 997 2646	814172	12000552	
47391	100,00	130,00	13,00	AS	NBR	4377	front & rear axle	DB	011 997 3646	814172	12000552	
81075	100,00	130,00	13,00	AW/BS	NBR	61447	front-/rear axle	DB	015 997 4347	814172	12000552	
114626	100,00	130,00	13,00	AW/BS	NBR	61447	front-/rear axle	DB	019 997 4747		12016930	
117409	100,00	130,00	13,00	CS	NBR	81335	wheel hub	IVECO	4000 1910		12011415	
82366	100,00	130,00	13,00	CS	NBR	81335	wheel hub	IVECO	4000 1913		12011415	
33649	100,00	130,00	13,00	B	NBR	19869	front-/rear axle	MAN	06 56281 0605	519243		81-35151-00
35259	100,00	130,00	13,00	AW/BS	NBR	61447	front-/rear axle	MAN	06 56289 0267			
117410	100,00	130,00	14,00	C WD	ACM	114451	crankshaft	IVECO	4010 0110		12001580	
114506	100,00	130,00	14,00	C WD	ACM	114451	crankshaft	IVECO	4010 0113		12001580	
117755	100,00	130,00	17,00	CA	NBR	117760	wheel hub	DAF	1700 329		19034569	
113946	100,00	135,00	13,00	AS WD	NBR	113945	wheel hub	DAF	0647 330		12015029	
82176	100,00	135,00	13/15	SP	NBR	81333	wheel hub	ROR	212 201 58		12017274	
117356	100,00	140,00	15,00	A/BS WD W	FPM	84452	wheel hub	EVOBUS	4 753 902 000			
117354	100,00	140,00	15,00	A/BS WD W	FPM	84452	wheel hub	EVOBUS	4 753 903 000			
117353	100,00	140,00	15,00	A/BS WD W	FPM	84452	wheel hub	EVOBUS	4 753 904 000			
117355	100,00	140,00	15,00	A/BS WD W	FPM	84452	front axle	EVOBUS	4 753 907 000			
84453	100,00	140,00	15,00	A/BS WD W	FPM	84452	front axle	KB	4 753 656 0000			
117350	100,00	140,00	15,00	A/BS WD W	FPM	84452	wheel hub	ZF	0750 111 328			

dph-no	dim 1	dim 2	dim 3	Style	Material	dph oil seal no.	Application	Type	OEM-NO	Elring	Corteco	Reinz
84770	100,00	140,00	15,5/20	KA	FPM	113947	wheel hub	DAF	1278 420		01015141	
94314	100,00	140,00	15,5/20	KA	FPM	113947	wheel hub	VOLVO	1 593 459		01015141	
81802	100,00	140,00	15/20,5	CS SP	NBR	81800	wheel hub	DAF	1238 034		12015758	
113949	100,00	150,00	15/20	KA SP	FPM	113948	crankshaft	DAF	1278 423		01015348	
109610	100,00	140/166,00	16/22	SP	NBR	112832	ABS	DAF	1334 961		01026332	
96931	101,00	114,00	10,00	BS	NBR	96930		Toyota	90033-19001			
114627	103,00	127,00	13,00	SP	PTFE	114412		CUMMINS	3020184			
82335	104,00	130,00	15/33	B SP	NBR	82334	wheel hub	DEUTZ	342 7559	044636		
82536	105,00	120,00	8,00	BS	NBR	81356	wheel hub	BPW	02 5664 04 00	495590		
109581	105,00	125,00	13,00	A/BS LD	ACM	109580	crankshaft	DEUTZ	417 5433	746310	12019078	81-31440-00
96915	105,00	125,00	12/9,5	AW/BS LD SP	FPM	96914	gearbox	ZF	0734 319 459		01026691	
47512	105,00	130,00	12,00	AW/BS RD vlies	FPM	112532	crankshaft	DB	003 997 0747	524972	12014447	
47515	105,00	130,00	12,00	AW/BS RD vlies	FPM	112532	crankshaft	DB	003 997 1347	052492		
47538	105,00	130,00	12,00	A/BS LD	FPM	48035	crankshaft	DB	004 997 1047		12014447	
47025	105,00	130,00	12,00	AW/BS RD vlies	FPM	112532	crankshaft	DB	005 997 5146	524972		
47592	105,00	130,00	12,00	AW/BS RD vlies	FPM	112532	crankshaft	DB	006 997 1647	524972		
47594	105,00	130,00	12,00	AW/BS RD vlies	FPM	112532	crankshaft	DB	006 997 2347	524972	12014447	
47659	105,00	130,00	12,00	AS	NBR	97860		DB	009 997 0647	282200	12013364	
47662	105,00	130,00	12,00	AW/BS RD vlies	FPM	112532	crankshaft	DB	009 997 3447	524972	12014447	
47381	105,00	130,00	12,00	AW/BS RD vlies	FPM	112532	crankshaft	DB	011 997 1346	524972		
36222	105,00	130,00	12,00	AW/BS RD vlies	FPM	112532	crankshaft	DB	012 997 7447	524972	12014447	
37088	105,00	130,00	12,00	AW/BS RD vlies	FPM	112532	crankshaft	DB	014 997 4647	524973	01016267	81-23301-60
104349	105,00	130,00	12,00	AW/BS RD vlies	FPM	112532	crankshaft	DB	014 997 4648			
37089	105,00	130,00	12,00	AW/BS RD vlies	FPM	112532	crankshaft	DB	019 997 6647			
47419	105,00	130,00	12,00	AW/BS RD vlies	FPM	47978	crankshaft	DB	403 997 0146	524972		
80244	105,00	130,00	12,00	AW/BS RD vlies	FPM	112532	crankshaft	MAN	51 01510 0138	288039		
61360	105,00	130,00	12,00	AW/BS RD vlies	FPM	112532	crankshaft	MAN	51 01510 0150			
82544	105,00	130,00	12,00	AS W RD SP	PTFE	109245	crankshaft	MAN	51 01510 0197	766852	01017541	81-23112-30
112554	105,00	130,00	12,00	AS W RD SP	PTFE	109245	crankshaft	MAN	51 01510 0226	766852	01017541	
81122	105,00	130,00	12,00	AS W RD SP	PTFE	109245	crankshaft	MAN	51 01510 6004	766852	01017541	81-23112-30
80059	105,00	130,00	12,00	AS	NBR	97860	gearbox	MAN	81 96502 0349	282200	12011062	
61236	105,00	130,00	12,00	A/BS LD	FPM	48035	crankshaft	MAN	81 96502 0350	314994	01018282	
114628	105,00	130,00	12,00	A/BS LD	FPM	48035	crankshaft	ZF	0734 310 124		12013364	
82327	105,00	130,00	12,00	A	NBR	18844	crankshaft	ZF	0750 110 001		12011062	
35021	105,00	130,00	13,00	C	NBR	18846	front axle	DB	000 997 6447	042846	12011403	81-35098-00

Dimensions

Dimensions

dph-no	dim 1	dim 2	dim 3	Style	Material	dph oil seal no.	Application	Type	OEM-NO	Eling	Corteco	Reinz
46965	105,00	130,00	13,00	C	NBR	18846	front axle	DB	003 997 4546		12011403	
116123	105,00	130,00	13,00	A	NBR	19876	F4L514	DEUTZ	117 0229			
114629	105,00	130,00	13,00	C	NBR	18846	front axle	MAN	06 56289 0113	042846	12011403	81-35098-00
112545	105,00	130,00	15,00	AW/BS F LD	FPM	82048	crankshaft	DEUTZ	241 3332			81-23301-40
80869	105,00	130,00	15,00	BS LD LA	MVQ	61098	crankshaft	DEUTZ	241 8366			
114630	105,00	130,00	15,00	AW/BS F LD	FPM	82048	crankshaft	DEUTZ	241 8366		12012581	
70549	105,00	130,00	15,00	AW/BS F LD	FPM	82048	crankshaft	DEUTZ	242 1820	756148	12012581	81-23301-40
61098	105,00	130,00	15,00	BS LD LA	MVQ	61098	crankshaft	DEUTZ	242 1820			
117307	105,00	130,00	15,00	AW/BS F LD	FPM	82048	crankshaft	MAN	K0 00242 1820			
114631	105,00	130,00	12/17	AW/BS	FPM	114413	crankshaft	MAN	06 56289 0389		01029917	
47660	105,00	130,00	12/9,5	AW/BS LD	ACM	95476		DB	009 997 0747	314994	01018282	
96417	105,00	130,00	12/9,5	AW/BS LD	ACM	95476	gearbox automatic	DB	021 997 6447		01016923	
95880	105,00	130,00	12/9,5	AW/BS LD	ACM	95476	crankshaft	VOLVO	1 526 828			
95879	105,00	130,00	12/9,5	AW/BS LD	ACM	95476	gearbox	ZF	0734 319 551		01016923	
111750	105,00	130,00	12/9,5	AW/BS LD	ACM	95476	gearbox	ZF	0750 111 341		01016923	
114483	105,00	136,00	13,00	CS	NBR	114427	wheel hub	IVECO	4000 2851		12011416	
113835	105,00	140,00	18,00	KA SP	FPM	113833	wheel hub	MAN	81 96503 0171		12040000	
112590	105,00	140,00	13/12	CS WD	NBR	112591	crankshaft	SCANIA	368 542		01034659	
111373	105,00	150,00	12,00	BS SP	FPM	111386		DAF	1242 697			
93822	107,95	146,05	12,70	SP	NBR	93821		Hendrickson	501118			
82165	107,95	152,40	19,46	SP	NBR	82165	ABS axle	FRUEHAUF	M100500			
95633	107,95	152,40	28,57	SP	NBR	95633	axle	FRUEHAUF	AGA0564001			
113951	110,00	130,00	12,00	A/BS W blue	NBR	113950	wheel hub	DB	011 997 5847		12019646	
113956	110,00	130,00	12,00	AS W	FPM	113955		DB	024 997 8547	199450		
113939	110,00	130,00	12,00	A	NBR	18860	wheel hub	RVI	5000 675 159		07016686	
94317	110,00	130,00	12,00	AS	NBR	19879	crankshaft	VOLVO	968 013-3		12017368	
114632	110,00	130,00	12,00	AW/BS	FPM	113950	crankshaft	VOLVO PC	6 773 195-0			
84616	110,00	130,00	13,00	A	NBR	19880		DAF	0015 599			
95375	110,00	130,00	13,00	AS LD	MVQ	95375		I.H.C.				
111636	110,00	130,00	13,00	CS	NBR	111637	crankshaft	IVECO	247 5900		12012065	
35149	110,00	130,00	13,00	C	NBR	18863	rear axle	MAN	06 56289 0035		12012065	
109688	110,00	130,00	13,00	A/BS LD	FPM/PTFE	109691	crankshaft	MAN	51 01510 0151	323772	12015384	81-33801-00
111400	110,00	130,00	13,00	A/BS LD	PTFE	109691	crankshaft	MAN	51 01510 0218	503208	20029606	81-33801-00
114634	110,00	140,00	13,00	SP	PTFE	114415		CUMMINS	3016787			
35022	110,00	140,00	13,00	C blue	NBR	50802	rear axle	DB	000 997 7446	612103	12011404	

dph-no	dim 1	dim 2	dim 3	Style	Material	dph oil seal no.	Application	Type	OEM-NO	Eling	Corteco	Reinz
47301	110,00	140,00	13,00	C	NBR	50802	rear axle	DB	008 997 6246	612103	12011404	
114633	110,00	140,00	13,00	A/BS	NBR	114414	wheel hub	DB	017 997 1147	457680	12015500	
93449	110,00	140,00	13,00	CS	NBR	18871	wheel hub	MAN	06 56289 0236	105422	01003701	
93450	110,00	140,00	13,00	CS	NBR	18871		MAN	06 56289 0241			
114509	110,00	140,00	14,00	A SP	NBR	114453	crankshaft	IVECO	3 345 908			
61651	110,00	140,00	15,00	AS W SP	NBR	61650	front axle	SCANIA	375 087		12014464	
114512	110,00	140,00	17,00	KA	NBR	114455		RVI	5000 288 417			
114505	110,00	140,00	17,00	KA	NBR	114455		VOLVO	1 699 341			
46716	110,00	140,00	12/19	SP	FPM	117745	front wheel hub	VOLVO	1 089 552	522911	12014742	81-35101-00
61645	110,00	140,00	12/21	NBR SP	NBR	82425	front wheel hub	SCANIA	300 278		01002741	
46810	110,00	140,00	12/21	SP	NBR	82425	front axle	VOLVO	1 587 792	522910	12013870	
114635	110,00	140,00	15,5/20	KA	FPM	114416	gearbox	DAF	0893 004		01019705	
95153	110,00	145,00	13,00	BS LA LD	FPM	95925	crankshaft	STEYR	90 003 074 476			
95150	110,00	145,00	13,00	BS LA LD	FPM	95925	crankshaft	STEYR	90 003 078 871			
93828	110,00	146,00	24,00	SP	NBR	93827	axle	TRAILOR	6502085P			
118665	110,23	145,00	10/12	SP	FPM	116318	crankshaft FM9	VOLVO	20 832 385		01031695	
84205	110,30	113,30	12/10	C	NBR	68848	front axle	DB	016 997 6347		01019319	
46949	110,30	133,30	12	C	NBR	46950	front axle	DB	002 997 6446	210382	01019319	
47516	110,30	133,30	12/10	C	NBR	68848	front axle	DB	003 997 2247	210382	01019319	
119335	111,12	146,05	14,28	SP	NBR	97195	axle	TRAILOR	6502085T		12017210	
114445	111,12	146,05	24,21	SP	NBR	84679	axle	IVECO	247 9949			
84679	111,12	146,05	24,21	SP	NBR	84679	axle	TRAILOR				
51489	112,00	132,00	7,50	BAB	FPM	51488		DB	009 997 9747			
112939	112,00	132,00	7,50	BAB	FPM	51488		DB	014 997 8947			
113851	112,00	132,00	7,50	BAB	FPM	51488	rear axle	MAN	06 56289 0344			
61643	113,00	136,00	10,90	A SP	NBR	61642	rear axle	SCANIA	297 999	586781	12014734	
113838	113,00	140,00	12,00	A/B	ACM	113837	wheel hub	MAN	06 56279 0341			
112552	114,00	135,00	13,00	AW BS LD	FPM	116149	crankshaft	IVECO	4000 3800		12011318	
94835	114,00	142/170	14/27	B SP	NBR	94834	wheel hub	DAF	0190 069		19031938	
119110	114,10	152/159,30	14,00	KA	FPM	111390	crankshaft	IVECO	4010 2320		12017353	
111377	114,10	152/159,30	14,00	KA	FPM	111390	crankshaft	IVECO	4010 2321		12017353	
82533	115,00	133,00	13,00	AS W WD	NBR	82532	wheel hub	BPW	02 5664 18 57	216320	01033476	
109146	115,00	136,70	8/12	AS SP	NBR	113537	axle	BPW	02 5664 55 64		01016766	
93811	115,00	136,70	8/12	AS SP	NBR	113537	axle	BPW	02 5664 57 00	495600	01016766	
81131	115,00	140,00	12,00	AS W LD	MVQ	81129	crankshaft	STEYR	90 003 074 377			

Dimensions

Dimensions

dph-no	dim 1	dim 2	dim 3	Style	Material	dph oil seal no.	Application	Type	OEM-NO	Elring	Corteco	Reinz
47690	115,00	140,00	13,00	A/BS blue	NBR	48022	rear axle	DB	010 997 7847	562882	12015887	
47691	115,00	140,00	13,00	A/BS blue	NBR	48022	rear axle	DB	010 997 7947	562882	12015887	
47694	115,00	140,00	13,00	A/BS blue	NBR	48022	rear axle	DB	010 997 8447	562882	12015887	
47397	115,00	140,00	13,00	CS	NBR	51724	front axle	DB	011 997 5446	518166	12003473	81-35102-00
46849	115,00	140,00	13,00	CS	NBR	51724	front axle	DB	011 997 7745			
82227	115,00	140,00	13,00	CS	NBR	51724	front axle	DB	011 997 7747			
113042	115,00	140,00	13,00	AW/BS LD	PTFE/ACM	114417	crankshaft	DB	021 997 5347	445600	20029785	81-36197-00
47743	115,00	140,00	13,00	A	NBR	18885	rear axle	DB	303 997 0647	019364		
112540	115,00	140,00	13,00	A BS blue	NBR	48022	rear axle	IVECO	4203 1150		12015887	
35150	115,00	140,00	13,00	CS green	NBR	51724	front axle	MAN	06 56289 0037	518166	12003473	81-35102-00
112514	115,00	140,00	13,50	AS LD	FPM/ACM	115617	crankshaft	DEUTZ	423 2267	033377	20020387	81-20481-30
35128	115,00	140,00	15,00	C	NBR	18888		MAN	06 56282 0906			
50874	115,00	140,00	16,00	BS LA LD	FPM	48305	crankshaft	DEUTZ	223 4134	033376	12012148	
51674	115,00	140,00	16,00	BS LA LD	FPM	48305	crankshaft	DEUTZ	415 0783	033376	12012148	81-20481-20
94524	115,00	140,00	16,00	BS LA LD	FPM	48305	crankshaft	DEUTZ	423 0193	033376		
82331	115,00	140,00	16,00	BS LA LD	FPM	48305	crankshaft	DEUTZ	423 0392	033376	12012148	
119131	115,00	140,00	16,00	BS LA LD	FPM	48305	crankshaft	DEUTZ	415 2349	033376	12012148	
47003	115,00	150,00	13,00	C	NBR	18892		DB	004 997 7446			
46846	115,00	150,00	13,00	C	NBR	18892	rear axle	DB	004 997 7745	044660	12003475	
47299	115,00	150,00	13,00	C	NBR	18892	rear axle	DB	008 997 6046	044660		
46887	115,00	150,00	15,00	CS	NBR	46939	rear axle	DB	000 997 5446			
118375	116,00	140,00	10,00	WD	FPM	120126	crankshaft	MAN	06 56289 0393			
118376	116,00	151,00	11,00	SP	FPM	119761	with impulse wheel	MAN	81 96503 0414			
95254	117,00	152,00	15,00	SP	NBR	94016	axle	ROR	210 206 65			
94017	117,07	152,40	24,21	KA	NBR	94017	wheel hub	ROR	212 003 21			
114636	117,47	142,87	12,70	CS	NBR	81339	wheel hub	IVECO	4000 1010		12011417	
81569	117,47	142,87	12,70	CS	NBR	81339	wheel hub	IVECO	4000 1920		12011417	
34423	117,47	142,87	12,70	A blue	NBR	84532	crankshaft	SCANIA	173 320	325511	12011073	
114444	117,48	152,36	22,00	SP KA	NBR	113977	wheel hub	IVECO	247 5977		12018944	
93390	117,48	152,36	22,00	KA	NBR	113977	axe	ROR	212 003 21		12018944	
113978	117,48	152,36	22,00	KA	NBR	113977	crankshaft	RVI	5010 368 901		12018944	
81330	117,48	152,36	22,00	KA	NBR	113977	STEMCO 2110	VOLVO	247 597		12018944	
118540	117,48	152,38	24,40	SP	NBR	118540	wheel hub	RVI				
114508	117,48	152,40	25,40	KB	NBR	93393	wheel hub	RVI	5001 835 188			
93394	117,48	152,40	25,40	KB	NBR	93393	wheel hub	SAF	4 373 0035 01			

dph-no	dim 1	dim 2	dim 3	Style	Material	dph oil seal no.	Application	Type	OEM-NO	Elring	Corteco	Reinz
110008	117,50	158,00	17,80	A SP	NBR	113547	crankshaft	BPW	02 5664 68 00		01029718	
113548	117,50	158,00	17,80	A SP	NBR	113547	crankshaft	BPW	02 5664 74 00			
114510	118,00	136,00	13,00	B	NBR	18895	crankshaft	IVECO	4000 1060		12011347	
47517	118,00	140,00	13,00	B	NBR	47041	wheel hub	DB	003 997 2347		20016791	
47040	118,00	140,00	13,00	B	NBR	47041	front axle	DB	006 997 1346			
115847	120,00	140,00	12,00	AS W RD	PTFE/AEM	116003	crankshaft	SCANIA	1 392 708	152320		81-35997-00
48907	120,00	140,00	13,00	AW/BS LD	FPM	112531	crankshaft	DB	005 997 2647		12014877	
110389	120,00	140,00	13,00	A SP LD	FPM/ACM	110389	crankshaft	DB	005 997 2647			
47596	120,00	140,00	13,00	AW/BS LD	FPM	112531	crankshaft	DB	006 997 3347	090158	12014877	
47256	120,00	140,00	13,00	AW/BS LD	FPM	112531	crankshaft	DB	007 997 2446	090158	12014877	
95793	120,00	140,00	13,00	AW/BS LD	FPM	112531	crankshaft	DB	010 997 3647			
36223	120,00	140,00	13,00	AW/BS LD	FPM	112531	crankshaft	DB	013 997 1447	562920	12014877	81-23113-00
69541	120,00	140,00	13,00	AW/BS LD	FPM	112531	crankshaft	DB	014 997 1347	562920	12014877	
47737	120,00	140,00	13,00	AW/BS LD	FPM	112531	crankshaft	DB	016 997 0847	562920		
94513	120,00	140,00	13,00	BS	NBR	94932	crankshaft	IVECO	247 5845	105457	12012064	
113661	120,00	140,00	13,00	AS	NBR	42932	crankshaft	MAN	06 56289 0223		12000556	
37547	120,00	140,00	13,00	A LD	MVQ	37547	crankshaft	MAN	51 01510 0133			
36178	120,00	140,00	13,00	AW/BS LD	FPM	112531	crankshaft	MAN	51 01510 0133	090158	12014877	
37179	120,00	140,00	13,00	A/B LD SP	PTFE/ACM	109246	crankshaft	MAN	51 01510 0141		01016688	
108819	120,00	140,00	13,00	A/B LD SP	PTFE/ACM	109246	crankshaft	MAN	51 01510 0196	766828	01016688	
70512	120,00	140,00	13,00	A/B LD SP	PTFE/ACM	109246	crankshaft	MAN	51 01510 0206	766828	01016688	81-23113-30
112553	120,00	140,00	13,00	A/B LD SP	PTFE/ACM	109246	crankshaft	MAN	51 01510 0216			
109678	120,00	140,00	13,00	C	NBR	94015	crankshaft	SAF	4 373 0003 00	042935	12012064	
114637	120,00	140,00	13,00	CS	NBR	51716	front & rear axle	VOLVO	1 696 066		12012064	81-35104-00
96198	120,00	140,00	13,00	BS	NBR	94932	gearbox	DEUTZ	247 5845	105457		
114487	120,00	140,00	14,00	AW/BS WD	FPM	114431	crankshaft	IVECO	4010 1103		12014302	
111646	120,00	140,00	13,5/15,5	AS WD W SF	FPM/ACM	113975	wheel hub	RVI	5003 087 034		20016794	
47693	120,00	145,00	13,00	CS	NBR	51716	front & rear axle	DB	010 997 8147	567108	12015886	
47038	120,00	145,00	15,00	C	NBR	43207	rear axle	DB	006 997 0546	044679	12011405	81-35106-00
47010	120,00	145,00	15/12	C	NBR	50805	rear axle	DB	005 997 0346	044679		81-35106-00
50805	120,00	145,00	15/12	C	NBR	50805	rear axle	DB	006 997 0546			
47257	120,00	145,00	15/12	AW BS WD	FPM	95129		DB	007 997 2546			
50805	120,00	145,00	15/12	C	NBR	50805	rear axle	DB	007 997 2546			
47692	120,00	145,00	15/12	A/BS	NBR	48023	wheel hub	DB	010 997 8047	567108	12015886	
47695	120,00	145,00	15/12	A/BS	NBR	48023	wheel hub	DB	010 997 8547	567108		

Dimensions

Dimensions

dph-no	dim 1	dim 2	dim 3	Style	Material	dph oil seal no.	Application	Type	OEM-NO	Eling	Corteco	Reinz
95130	120,00	145,00	15/12	AW BS WD	FPM	95129	rear axle	DB	015 997 9347	008231	01026319	
114513	120,00	146,00	19,56	SP	NBR	114457		VOLVO	1 699 171			
113980	120,00	150,00	15,00	AW/BS	FPM	113979	wheel hub	RVI	5010 443 189		01030102	
18904	120,00	150,00	15,00	C	NBR	18904	front axle	MAN	06 56289 0221	042943		
47488	120,00	150,00	15/12	CS	NBR	48002	front axle	DB	002 997 1847	010901		81-35103-00
47489	120,00	150,00	15/12	CS	NBR	48002	front axle	DB	002 997 1947	010901		
47490	120,00	150,00	15/12	CS	NBR	48002	front axle	DB	002 997 2047	010901		81-35103-00
47541	120,00	150,00	15/12	CS	NBR	48002	front axle	DB	004 997 1747	010901	12011418	81-35103-00
47542	120,00	150,00	15/12	CS	NBR	48002	front axle	DB	004 997 1847	010901	12011418	81-35103-00
93379	120,00	150,00	15/12	CS	NBR	48002	front axle	DB	009 997 9046		12011418	
84224	120,00	150,00	15/12	AW/BS	NBR	84716	wheel hub	DB	019 997 4847	457710		
114638	120,00	150,00	15/12	AW/BS	NBR	84716	wheel hub	DB	020 997 5847		12016441	
109419	120,00	150,00	15/12	CS	NBR	48002	front axle	MAN	06 56282 1007			
80283	120,00	150,00	15/12	CS	NBR	48002	front axle	MAN	06 56289 0221			
35202	120,00	150,00	15/12	CS	NBR	48002	front axle	MAN	81 96501 0136			
113959	120,00	150,00	15/12	AW/BS	NBR	84716	wheel hub	RVI	0024 472 709		01016917	
109601	120,00	150,00	14,3/20	SP	FPM	109605	wheel hub	DB	024 997 4847			
114491	120,00	150,00	15/20,2	A/BS	NBR	114428	wheel hub	DB	013 997 7346	383260	01033873	
114639	120,00	160,00	15,00	AS WD	NBR	110539	crankshaft	DEUTZ	430 4616		01026509	
110540	120,00	160,00	15,00	AS WD	NBR	110539	wheel hub	RVI	5000 671 980		01016684	
111645	120,00	160,00	15,00	AS WD	NBR	110539	wheel hub	RVI	5000 788 490		01016684	
81796	120,00	160,00	17,50	C SP	NBR	81799	axle	DAF	0678 157		01015143	
114315	120,00	142/150,00	37,00	SP	NBR	114314	wheel hub	DAF	0500 162		01032389	
109157	120,65	146,05	12,70	A	NBR	84534	front axle	DAF	140 619			
70485	120,65	146,05	12,70	A	NBR	84534	front axle	SCANIA	32 898			
93398	120,65	152,40	22,22	SP	NBR	84681	axle	ROR	210 206 63			
82963	120,65	160,35	30,56	SP	NBR	93222	crankshaft	IVECO	247 9330			
115624	121,03	160,30	30,15	LA	NBR	115624		DB	386 997 7247			
119096	122,00	141,00	12,00	AS	MVQ	95376	crankshaft	FORD	3 905 794			
114641	122,00	152,00	13,00	SP	NBR	94012	axle	ROR	990 420 15			
114642	122,00	152,50	14,50	SP	PTFE	114418		CUMMINS	3023867			
109592	124,00	150,00	14,30	SP	NBR	109591	124x150x14,3/120x140x14,3	DB		021 997	6947220450	01028965
82535	125,00	142,00	13,00	AS W WD	NBR	82534	crankshaft	BPW	02 5664 28 57	292650	01019878	
82537	125,00	143,00	13,00	AS WD W	NBR	80457	wheel hub	BPW	02 5664 26 57	817252	12015710	
111427	125,00	148,00	9/7	A/BS SP	FPM	111426		VOLVO	20 399 560			

dph-no	dim 1	dim 2	dim 3	Style	Material	dph oil seal no.	Application	Type	OEM-NO	Eling	Corteco	Reinz
111429	125,00	148,30	8,1/9,3	KA/BS SP	FPM	111428		VOLVO	20 518 642			
117371	125,00	150,00	10,00	SP RD	FPM/ACM	97662	gearbox	MAN	81 96502 0313			
97663	125,00	150,00	10,00	A/B W RD	FPM/ACM	97662	crankshaft	ZF	0734 310 165		20020422	
47742	125,00	150,00	13,00	CS	NBR	81334	crankshaft	DB	303 997 0147	635600		
117411	125,00	150,00	13,00	CS	NBR	81334	crankshaft	IVECO	4000 1930		12011419	
84199	125,00	150,00	13,00	CS	NBR	81334	crankshaft	IVECO	4000 1933	022560	12011419	
114643	125,00	150,00	13,00	CS	NBR	81334	crankshaft	MAN	06 56289 0038	635600	12011419	
93558	125,00	150,00	13,00	CS	NBR	81334	crankshaft	SAF	4 373 0008 00		12011419	
81414	125,00	150,00	13,00	BS	NBR	18911	wheel hub	VOLVO	946 093-2	108626	12011367	
97220	125,00	150,00	14,00	SP	FPM	113954	wheel hub	DB	022 997 5247	451100	01027682	
93430	125,00	150,00	14,00	AS SP	NBR	93429	crankshaft	SCANIA	1 334 535	457590	12016695	
109162	125,00	150,00	15,00	AS/BW LD	FPM	51252	crankshaft	DAF	0240 443			
82344	125,00	150,00	15,00	AS/BW LD	FPM	51252	crankshaft	DAF	0266 146			
51890	125,00	150,00	15,00	AS/BW LD	FPM	51252	crankshaft	DAF	0682 962	493360		
109156	125,00	150,00	15,00	AS/BW LD	FPM	51252	crankshaft	DAF	1275 082	493360		81-24476-20
47022	125,00	150,00	15,00	C	NBR	50804	rear axle	DB	005 997 4446		01003494	
47593	125,00	150,00	15,00	C	NBR	50804	rear axle	DB	006 997 2147		01003494	
47300	125,00	150,00	15,00	C	NBR	50804	rear axle	DB	008 997 6146			
114644	125,00	150,00	15,00	AS/BW LD	FPM	51252	crankshaft	IVECO	4010 1400		12015746	81-24476-20
95294	125,00	150,00	12/14	AS W	NBR	95318	crankshaft	STEYR	90 003 074 484			
94407	125,00	150,00	15/13	A/BS WD F	NBR	94406	rear axle	DB	015 997 5647	210294	12015501	
95097	125,00	150,00	15/13	A/BS WD	FPM	95098		DB	016 997 7747	457620	19020065	81-35109-00
46879	125,00	152,40	15,00	CS	NBR	94589	rear axle	DB	000 997 4046	044687	12011406	81-35107-00
47471	125,00	152,40	15,00	CS	NBR	94589	rear axle	DB	001 997 3847	044687	12011406	81-35107-00
33377	125,00	152,40	15,00	CS	NBR	94589	rear axle	DB	002 997 4046	044687	12011406	
61649	125,00	160,00	15,00	AS W	NBR	61648	crankshaft	SCANIA	375 086		12014463	
81801	125,00	160,00	17,00	KA SP	FPM	81798	axle	DAF	0292 766		01015140	
114313	125,00	160,00	17,00	KA SP	FPM	81798	axle	SCANIA	350 984		01015140	
46971	125,00	160,00	18,00	BS LD F	FPM	36207	crankshaft	DB	003 997 6746	316385		
36216	125,00	160,00	18,00	BS LD F	FPM	36207	crankshaft	DB	004 997 9347	316385	12012432	81-21040-10
47335	125,00	160,00	18,00	BS LD F	FPM	36207	crankshaft	DB	009 997 5146	316385	12012432	
109609	125,00	160/190,00	18/20	KA SP	FPM/PA	109760	ABS	DAF	1335 063		01026336	
93825	125,41	160,33	12,70	SP	NBR	93824	800 series axle	Hendrickson	502776			
61171	126,50	148,00	14,70		metal	61171	rear axle	VOLVO	944 670-9			
94316	126,75	168,00	15,00	C SP	NBR	119900	front & rear axle	VOLVO	944 671-7			

Dimensions

Dimensions

dph-no	dim 1	dim 2	dim 3	Style	Material	dph oil seal no.	Application	Type	OEM-NO	Eling	Corteco	Reinz
113536	126,85	157,00	8,70	SP	FPM	113535	crankshaft	SAF	4 373 0041 01		01029721	
113546	126,85	153/157,00	8,80	A SP	NBR	113544	crankshaft	SAF	4 373 0042 01		01029720	
49099	127,00	150,00	12,00	A/BS LD	FPM	94791	crankshaft	VOLVO	471 056-2		12013863	
115988	127,00	150,00	12,00	A LD	MVQ	50795	crankshaft	VOLVO	471 056-2	518360		
36586	127,00	150,00	12,00	A LD	MVQ	50795	crankshaft	VOLVO	477 119-2			
110486	127,00	150,00	12,00	A/BS LD	FPM	94791	crankshaft	VOLVO	477 119-2	518361	12013863	81-26294-10
114488	128,00	148,00	12,00	AW/BS WD	FPM	114430	crankshaft	IVECO	4010 1113		12012815	
46891	128,00	150,00	13,00	A	NBR	25024		DB	000 997 7346			
114514	128,00	144/152,30	11/25	SP	FPM	114458	wheel hub	IVECO	4010 2103		12015506	
96680	130,00	150,00	13,00	AS LD FILZ	FPM/ACM	96235	crankshaft	DEUTZ	425 3333	084610	01027763	81-36001-00
119410	130,00	150,00	13,00	AS W LD	PTFE	119417	crankshaft	RENAULT	50 03 087 026			81-37934-00
114645	130,00	150,00	14,50	BS W SP	PTFE	112489		CUMMINS	3933262			
70461	130,00	160,00	13,00	B	NBR	45614	rear axle	SCANIA	178 866	281972		
111272	130,00	160,00	13,00	SP	PTFE	111404	crankshaft	SCANIA	369 478	354390	20017235	81-25014-20
114647	130,00	160,00	15,00	AS	NBR	19889	crankshaft	MAN	06 56289 0244		12011213	
34428	130,00	160,00	15,00	AS W LD	MVQ	48518	crankshaft	SCANIA	231 938	587079	12013893	81-25014-10
69285	130,00	160,00	15,00	AW/BS LD	FPM	93307	crankshaft	SCANIA	366 303	587070	12013893	81-25014-10
114646	130,00	160,00	15,00	AW/BS RD	FPM	97703	crankshaft	VOLVO	1 668 341		01031088	
50742	130,00	160,00	15,00	AS W LD	MVQ	48518		VOLVO	231 938			
97594	130,00	160,00	15,00	AW/BS LD	FPM	93307	crankshaft	VOLVO	424 763			
114648	130,00	160,00	16,00	A/BS WD	FPM	81341	crankshaft	MAN	06 56289 0306		01017013	
81568	130,00	160,00	16,00	A/BS WD	FPM	81341	crankshaft	MAN	06 56289 0385	290180	01017013	
82209	130,00	170,00	15,00	C	NBR	32120		DB	001 997 0246			
114499	130,00	170,00	17,00	KA SP	FPM	96427	crankshaft	SCANIA	1 329 839			
96326	130,00	170,00	17,00	KA	FPM	96427	wheel hub	ZF	0734 310 285			
115094	130,00	170,00	18/20	KA	FPM	114448	crankshaft	DB	013 997 5946		12019945	
114501	130,00	170,00	18/20	KA	FPM	114448	crankshaft	SCANIA	1 415 136		12019945	
114502	130,00	170,00	18/20	KA	FPM	114448	crankshaft	ZF	0734 319 610		12019945	
114852	131,00	75,40	16,00	SP	NBR	114851		MAN	06 56279 0259			
111280	132,00	160,00	10,00	B WD	FPM	111357	crankshaft	MAN	06 56289 0387	485890	12020156	
111281	132,00	172,00	12,00	KA/BS SP	FPM	111358	wheel hub	MAN	81 96503 0333			
114649	133,00	160,00	15,00	AS W LD	FPM	114419	crankshaft	DEUTZ	1215 2280		20020505	81-23364-00
36375	133,30	155,60	14,00	B WD	NBR	36376	wheel hub	VOLVO	944 667-5	522856	12011387	81-35111-00
114650	133,35	155,60	14,00	B WD	NBR	36376	wheel hub	VOLVO	1 577 624		12011387	
82507	133,35	158,75	12,70	AS LD	FPM	82505	crankshaft	PERKINS	2418 F 475		12010753	

dph-no	dim 1	dim 2	dim 3	Style	Material	dph oil seal no.	Application	Type	OEM-NO	Eling	Corteco	Reinz
119101	134,00	152,00	14,00	A/CS WD W	ACM	81344	wheel hub	IVECO	4010 0650		12014598	
81572	134,00	152,00	14,00	A/CS WD W	ACM	81344	wheel hub	IVECO	4010 0653		12014598	
120080	134,00	161,00	16,00	A RD	NBR	120079	crankshaft	DAF	1 684 105			81-37174-00
120452	135,00	160,00	12,00	A/BS LD	NBR	96476	crankshaft	Steyr	90003 070 056			
114482	135,00	160,00	13,00	CS	NBR	114433	crankshaft	IVECO	3 414 237			
84196	135,00	160,00	16/13	AW/BS LD F	FPM	82799	crankshaft	DEUTZ	242 7225	830887	01016937	81-26023-00
114651	135,00	165,00	12,00	A/BS WD	FPM	98291	crankshaft	ZF	0734 310 102			
94315	135,00	165,00	17,00	SP	NBR	95388	crankshaft	VOLVO	6 771 541-7			
47310	135,00	165,00	13/10	C	NBR	50339	rear axle	DB	009 997 0246			
35151	135,00	165,00	13/10	C blue	NBR	50339	rear axle	MAN	06 56289 0039			
47251	135,00	165,00	14/10	BS	NBR	50340	rear axle	DB	007 997 0446			
47311	135,00	165,00	13/15	BS	NBR	48046	rear axle	DB	009 997 0346			
84449	135,00	170,00	18,00	SP	PTFE/NBR	97004		KB	4 753 571 0000			
115627	135,00	171,37	15,00	C SP	FPM	115626		DB	006 997 4046			
96174	135,00	175,00	18,00	KA/BS SP	FPM/NBR	96648	wheel hub	MAN	81 96503 0188	009310	12020157	
113834	135,00	175,00	18,00	KA SP	FPM/NBR	118425	ABS	MAN	81 96503 0260			
113841	135,00	175,00	18,00	SP	FPM/ACM	113840	wheel hub	MAN	81 96503 0298			
98697	135,00	175,00	18,00	KA/BS SP	FPM/NBR	96648	wheel hub	MAN	81 96503 0398		12020157	
114652	135,00	175,00	15,5/20	KA	NBR	114420	crankshaft	MAN	06 56289 0268	357170	01019880	
112979	136,00	159,00	13,00	A/B RD	PTFE/ACM	112984		VOLVO	1 549 398			
70447	136,52	161,92	12,70	A	NBR	24777	rear axle	SCANIA	121 257		20016795	
115633	136,80	165,00	13,00	KA	NBR	115632	crankshaft	DB	022 997 6247			
119000	136,80	165,00	13,00	KA	NBR	115632	crankshaft	DEUTZ	439 3239		12019619	
115634	136,80	165,00	13,00	KA	NBR	115632	crankshaft	ZF	0734 309 291		12019619	
119001	136,80	165,00	13,00	KA	NBR	115632	crankshaft	ZF	0734 309 422		12019619	
70481	137,00	161,92	15/12	BS WD LA SP	NBR	61646	crankshaft	SCANIA	297 991	586803	12012241	
61647	137,00	161,92	15/12	BS WD LA SP	NBR	61646	rear axle	SCANIA	370 074		12012241	
109470	137,00	165,00	13,50	KA SP	FPM/NBR	109471	crankshaft	DB	018 997 3347		01025609	
84395	138,00	160,00	15,00	AS LD	MVQ	15300		MAN	51 01510 0072			
95103	138,00	160,00	15,00	AW/BS LD	FPM	95103						
113843	139,00	170,00	11,00	B LA SP	FPM	113842	crankshaft	MAN	81 96503 0445	517130	12019163	
117372	139,00	170,00	11,00	B SP LA	FPM	113842	crankshaft	MAN	81 96503 0530			
113827	139,00	175/205,00	11/16,30	SP	FPM	113828	wheel hub	MAN	81 96503 6000	457300	12019683	
117900	140,00	160,00	12,00	AW	MVQ	117900						
47493	140,00	160,00	13,00	BS	NBR	70576	rear axle	DB	002 997 3247	255637	12011349	

Dimensions

Dimensions

dph-no	dim 1	dim 2	dim 3	Style	Material	dph oil seal no.	Application	Type	OEM-NO	Eling	Corteco	Reinz
117412	140,00	160,00	13,00	BS	NBR	70576	rear axle	IVECO	4560 719		12011349	
84394	140,00	160,00	13,00	BS	NBR	70576	rear axle	MAN	06 56289 0186	255637	12011349	
113972	140,00	160,00	13,00	AS W WD blue	NBR	113971	wheel hub	RVI	5000 654 396		20016681	
113974	140,00	160,00	13,00	AS W WD blue	NBR	113971	wheel hub	RVI	5001 858 475		20016681	
84397	140,00	160,00	13,00	C	NBR	93856	crankshaft	SAF	4 373 0010 00		12017296	
81736	140,00	160,00	13,00	AS W	MVQ	81300	crankshaft	STEYR	90 003 074 387			
114507	140,00	160,00	14,00	C WD	ACM	114452	crankshaft	IVECO	4010 0103		12011593	
37599	140,00	164,00	20/23,50	SP	FPM	50173	rear axle	VOLVO	1 522 372	922277	12014656	
116234	140,00	164,00	20/23,50	SP	FPM	50173	rear axle	VOLVO	1 672 249	222757	12016932	
94368	140,00	165,00	12,00	C	NBR	68849	crankshaft	SAF	4 373 0004 00			
119103	140,00	165,00	15,00	A/BS LD W	FPM	81349	crankshaft	IVECO	4010 1430		12015780	
81574	140,00	165,00	15,00	A/BS LD W	FPM	81349	crankshaft	IVECO	4010 1433		12015780	
114443	140,00	165,00	15,00	SP	NBR/MVQ	118919	crankshaft	SCANIA	1 336 001			
47459	140,00	165,00	12/15	AS2W WD	FPM	47979	front axle	DB	001 997 0547	043990		
47549	140,00	165,00	12/15	AS2W WD	FPM	47979	front axle	DB	004 997 5947	043990		
47574	140,00	165,00	12/15	AS2W WD	FPM	47979	front axle	DB	005 997 4547	043990		
47595	140,00	165,00	12/15	AS2W WD	FPM	47979	front axle	DB	006 997 3147	043990		
113927	140,00	165,00	12/15	AS2 W	FPM	47979	front axle	DB	021 997 1147			
95217	140,00	165,00	12/15	AS2 W	FPM	47979	front axle	DB	021 997 2047			
109518	140,00	165,00	9,5/12	AS WD SP	FPM	109519	crankshaft	DB	016 997 7547	477140	01019879	
119102	140,00	170,00	14,00	A/CS WD W	ACM	81343	crankshaft	IVECO	4010 0660		12014601	
81573	140,00	170,00	14,00	A/CS WD W	ACM	81343	crankshaft	IVECO	4010 0663		12014601	
114653	140,00	170,00	14,00	A/CS WD W	ACM	81343	crankshaft	MAN	06 56282 1409		12001584	
114495	140,00	170,00	17,00	KA	FPM	114449	wheel hub	RVI	5000 823 891		12016451	
81575	140,00	160/190,00	14/28	special	NBR	81342	rear axle	IVECO	4460 212			
114654	142,00	162,00	10/9,5	AS W RD	FPM	97820	crankshaft	ZF	0734 319 137		01029929	
98174	142,00	162,00	10/9,5	AS W RD	FPM	97820	crankshaft	ZF	0750 111 077		01029929	
112266	142,00	170,00	15/16	KA	NBR	112790	wheel hub	SCANIA	1 409 889	222620	12020496	
93432	142,00	180/185,00	7,50	B SP	NBR	93431	crankshaft	SAF	4 266 0028 01		01017375	
109596	142,15	175,50	11,40	AS SP	FPM	110394	axle	SAF	4 373 0043 00			
109598	142,15	175,50	11,40	AS SP	NBR	110392	axle	SAF	4 373 0044 00			
112560	142,50	175,00	13/16	AS W WD	NBR	113069	crankshaft	DB	008 997 5847		01017574	
112801	143,00	165,00	8,50	BABSL	NBR	112800	crankshaft	DB	011 997 3746		01030092	
114868	145,00	165,00	13,00	A/BS blue	NBR	114867	wheel hub	DB	019 997 9047		19032103	
35152	145,00	165,00	13,00	C	NBR	19960	front-/rear axle	MAN	06 56289 0040			

dph-no	dim 1	dim 2	dim 3	Style	Material	dph oil seal no.	Application	Type	OEM-NO	Eling	Corteco	Reinz
82078	145,00	167,00	13,00	AS WD W	NBR	80456	axle	BPW	02 5664 46 57	817260	12013359	
111638	145,00	170,00	13,00	BS blue	NBR	18949	wheel hub	IVECO	4000 0480		12011373	
32782	145,00	170,00	15,00	C	NBR	18951	crankshaft	MAN	06 56289 0041		01003537	
111548	145,00	170,00	15/12	B SP	FPM	111230	crankshaft	SCANIA	370 076 FPM			
116175	145,00	170,00	14,5/18	KA/BS SP	FPM	96110	wheel hub	SCANIA	1 303 673			
96111	145,00	170,00	14,5/18	KA BS SP	FPM	96110	wheel hub	SCANIA	1 363 673			
34427	145,00	170,00	15/20	B SP	NBR	50174	rear axle	SCANIA	291 076	586838	12011388	
50177	145,00	170,00	15/20	B SP	NBR	50174	crankshaft	SCANIA	370 076	586838	12011388	
117770	145,00	170,00	15/20	B SP	NBR	50174	rear axle	SCANIA	550 174			
115203	145,00	175,00	8,00	B SP	NBR	114872	wheel hub	DB	013 997 3646		01034120	
114873	145,00	175,00	8,00	B SP	NBR	114872	wheel hub	DB	014 997 0546		01034120	
51433	145,00	175,00	13,00	A/B W blue	NBR	82427	rear axle	DB	001 997 0146			
47345	145,00	175,00	13,00	C	NBR	6729	rear axle	DB	009 997 9546			
47377	145,00	175,00	13,00	A/B W blue	NBR	82427	rear axle	DB	011 997 0146	294500	12014407	81-91001-00
36407	145,00	175,00	13,00	A/B W blue	NBR	82427	rear axle	DB	011 997 1246		12014407	
47389	145,00	175,00	13,00	C	FPM	97801	axle	DB	011 997 3146	033146		
47392	145,00	175,00	13,00	C	FPM	97801	axle	DB	011 997 3846	033146		
4375	145,00	175,00	13,00	A/B W blue	NBR	82427	rear axle	DB	011 997 4346		12011407	
47710	145,00	175,00	13,00	A/B W blue	NBR	82427	rear axle	DB	011 997 5247	208220		
47711	145,00	175,00	13,00	A/B W blue	NBR	82427	rear axle	DB	011 997 5347			
80835	145,00	175,00	13,00	AW/B	FPM	59311	rear axle	DB	013 997 5947	768057	12014739	81-35112-00
94399	145,00	175,00	13,00	A/B W blue	NBR	82427	rear axle	DB	013 997 6447	768065		
36646	145,00	175,00	13,00	AW/B	FPM	59311	rear axle	DB	013 997 9447	768057	12014739	
35156	145,00	175,00	13,00	A/B W blue	NBR	82427	rear axle	MAN	06 56289 0063		12011407	
34819	145,00	175,00	13,00	A/B W blue	NBR	82427	rear axle	MAN	06 56289 0065		12011407	
84522	145,00	175,00	13,00	C	FPM	34644	rear axle	MAN	06 56289 0066	033146		
34645	145,00	175,00	13,00	C	FPM	34644	rear axle	MAN	06 56289 0145	033146		
113844	145,00	175,00	13,00	AW/B	FPM	59311	rear axle	MAN	06 56289 0330			
114656	145,00	175,00	13,00	AW/B	FPM	59311	wheel hub	MAN	06 56289 0333		12014739	
32639	145,00	175,00	13,00	A/B W blue	NBR	82427	rear axle	MAN	06 56289 0334	817023	12015499	81-91001-00
109841	145,00	175,00	13,00	C	FPM	97801	wheel hub	MAN	81 96501 0860	033146	12015499	
6654	145,00	175,00	13,00	A/B W blue	NBR	82427	rear axle	MAN	81 96501 0862			
111452	145,00	175,00	13,00	AS LD SF	PTFE	111451	crankshaft	SCANIA	1 375 002	090510	15026917	81-35996-00
111453	145,00	175,00	13,00	AS LD SF	PTFE	111451	crankshaft	SCANIA	1 433 183	090510	15026917	81-35996-00
116057	145,00	175,00	13,00	A/B W blue	NBR	82427	rear axle	SCANIA	1 433 186			

Dimensions

Dimensions

dph-no	dim 1	dim 2	dim 3	Style	Material	dph oil seal no.	Application	Type	OEM-NO	Elring	Corteco	Reinz
117413	145,00	175,00	13,00	C	NBR	6729	rear axle	RVI	5000 281 014		12011407	
47527	145,00	175,00	14,00	BS	NBR	4376	rear axle	DB	003 997 6647	208210	12011374	
47346	145,00	175,00	14,00	BS	NBR	4376	rear axle	DB	009 997 9646	002313		
47376	145,00	175,00	14,00	BS	NBR	4376	rear axle	DB	011 997 0046	002313	12011374	81-91002-00
81021	145,00	175,00	14,00	A/BS	NBR	81021	rear axle	DB	011 997 0046			
4440	145,00	175,00	14,00	BS green	NBR	4376	rear axle	DB	011 997 4446	002313	12011374	
51423	145,00	175,00	14,00	A/BS	NBR	81021	rear axle	DB	013 997 0547	768065	12014740	81-91002-00
51230	145,00	175,00	14,00	A/BS	NBR	81021	rear axle	DB	016 997 5647	768065	12014740	
34647	145,00	175,00	14,00	BS blue	NBR	4376	rear axle	MAN	06 56289 0027		12011374	
34818	145,00	175,00	14,00	BS	NBR	4376	rear axle	MAN	06 56289 0064		12011374	
82113	145,00	175,00	14,00	A/BS W	NBR	81021	rear axle	MAN	06 56289 0332	768065	12014740	
6652	145,00	175,00	14,00	A/BS blue	NBR	81021	rear axle	MAN	06 56289 0335	768065	12014740	81-91002-00
6649	145,00	175,00	14,00	A/BS blue	NBR	81021	rear axle	MAN	81 96501 0861		12014740	
114490	145,00	175,00	15,00	A W	ACM	114456	wheel hub	DB	013 997 3546	451110	01033415	
120386	145,00	175,00	15,00	AW/BS RD	FPM	120442	crankshaft	VOLVO PC	3 825 169	559030		
82322	145,00	175,00	16,00	AW/BS WD	FPM	82321	rear axle	MAN	06 56289 0309	826774	01016698	
93474	145,00	175,00	16,00	AW/BS WD	FPM	82321	rear axle	MAN	06 56289 0386	826774	01016689	
118372	145,00	175,00	16,00	AW/BS WD	FPM	82321	rear axle	DB	013 997 8946		01016689	
94319	145,00	175,00	17,00	SP	FPM	95207	wheel hub	VOLVO	1 594 257			81-35301-00
93291	145,00	175,00	19,00	SP	NBR	93292		VOLVO	3 123 521			
114871	145,00	175,00	13/12	A/BS WD	FPM	114870	crankshaft	MAN	81 35710 6015			
96261	145,00	175,00	14/12	A WD	FPM	96262	wheel hub	MAN	06 56289 0248			
95654	145,00	175,00	17/21	A/BS2 WD SP	FPM	95653	wheel hub	DB	020 997 3947	022850	01019352	81-35223-00
80461	145,00	175/205,00	9/14	SP	NBR	80460	rear axle	DB	015 997 4047			
82394	145,00	175/205,00	9/14	SP	NBR	80460	rear axle	DB	015 997 4947	147730	01027787	
114655	145,00	175/205,00	9/14	SP	NBR	80460	rear axle	DB	020 997 5247			
82320	145,00	175/205,00	9/14	SP	NBR	80460	rear axle	MAN	06 56289 0371	147730	01027787	
82049	145,00	175/205,00	18/20	special	FPM	82044	rear axle	DB	020 997 0547	147731	01019245	81-91000-00
114850	146,00	95,20	16,50	SP	NBR	114849		MAN	81 96503 0259			
47382	148,00	170,00	15,00	C	NBR	18953		DB	011 997 1646			
47386	148,00	170,00	15,00	C	NBR	18953		DB	011 997 2346			
80881	148,00	168/170,00	32,00	B WD F	NBR	80880	rear axle	VOLVO	944 665-9	522864	12011389	81-35113-00
114500	149,90	176,00	16,00	KA	NBR	104925	wheel hub	SCANIA	1 342 708		19026423	
93620	150,00	168,00	13,00	A	NBR	93620						
114879	150,00	170,00	12,00	AW BS	NBR	114876	crankshaft	IVECO	299 7032			

dph-no	dim 1	dim 2	dim 3	Style	Material	dph oil seal no.	Application	Type	OEM-NO	Elring	Corteco	Reinz
114877	150,00	170,00	12,00	AW/BS	NBR	114876	crankshaft	IVECO	4010 0393			
115205	150,00	170,00	12,00	AW/BS	NBR	114876		IVECO	4206 2983			
111635	150,00	170,00	15,00	CS	NBR	61249	crankshaft	IVECO	244 2744		12011423	
114657	150,00	170,00	15,00	CS	NBR	61249	crankshaft	MAN	06 56289 0115		12011423	
114658	150,00	170,00	15,00	CS	NBR	61249	crankshaft	SAF	4 373 0014 00		12011423	
114486	150,00	170,00	16,00	AW/BS WD	FPM	114426	crankshaft	IVECO	4010 1093		12015745	
115206	150,00	170,00	16,00	AW BS WD	FPM	114426		IVECO	4206 2984			
119407	150,00	172,00	13,00	AW LD W	PTFE/ACM	119414	crankshaft	RENAULT	50 10 359 807	457220	20026913	81-37933-00
80241	150,00	172,00	18,00	AT W LD	MVQ	68548	crankshaft	DEUTZ	116 0383	043095		81-21395-10
68847	150,00	180,00	8,50	BABSL	NBR	68847					01022273	
95894	150,00	180,00	10,00	BS2 SP	STEEL	95893	crankshaft	VOLVO	1 524 281		12016843	
112971	150,00	180,00	12,00	AS	NBR	112971	axle				12017022	
47758	150,00	180,00	13,00	AS	NBR	6713	front & rear axle	DB	317 997 0047		12011091	
110738	150,00	180,00	13	A	NBR	6713	front-/rear axle	IVECO	852 7970	109657	12011091	
109167	150,00	180,00	13,00	A	NBR	6713	front-/rear axle	DEUTZ	116 7518	109657		
47759	150,00	180,00	14,00	AS	NBR	44260	crankshaft	DB	335 997 0047		12011215	
110736	150,00	180,00	15,00	CS	NBR	94056		IVECO	812 3442			
112977	150,00	180,00	15,00	A/B W LD	PTFE/ACM	112978		VOLVO	8 148 259	515800		
48063	150,00	180,00	11/13	AS	NBR	48063	front-/rear axle	DEUTZ	116 7518			
95892	150,00	180,00	17,5/16	BS2 WD	FPM	95891	crankshaft	VOLVO	1 522 896	590738	12011324	
109599	150,00	196,00	16,00			109599	ABS	DB	942 356 0315	458 700		
34424	150,81	117,80	12,70	AS blue	NBR	84589	wheel hub	SCANIA	179 360			
34422	150,81	177,80	12,70	AS blue	NBR	84589	wheel hub	SCANIA	159 496	325503	12011092	
114659	151,00	171,00	11,00	SP	PTFE	114421	crankshaft	CUMMINS	3006737			
80013	152,40	120,65	13/12	SP	NBR	80012	front & rear axle	VOLVO	946 026-2	694088		
112972	152,40	177,80	12,70	AS	NBR	112972	axle				12017268	
114660	152,50	171,00	16,00	SP	PTFE	114422		CUMMINS	39823			
97822	154,00	180,00	12,00	A/BS LD	AEM/PTFE	115386	crankshaft	DAF	1340 320	017590	20029771	81-28539-00
117251	154,00	180,00	12,00	A/BS LD	PTFE/AEM	115386	crankshaft	DAF	1370 127	175990	20029771	
82346	154,00	180,00	15,00	AW/BS LD F	FPM	82345	crankshaft	DAF	0558 114		12015530	81-28539-00
109166	154,00	180,00	15,00	AW/BS LD F	FPM	82345	crankshaft	DAF	0682 961		12015530	
97821	154,00	180,00	15,00	AW/BS LD F	FPM	82345	crankshaft	DAF	1275 083		12015530	81-28539-00
112973	155,00	174,00	12,00	AS	NBR	112973	axle					
84444	155,00	180,00	15,00	SP	FPM	84441	wheel hub	EVOBUS	4 753 622 000			
15252	155,00	180,00	15,00	A/BS LD W	FPM	81702	crankshaft	VOLVO	469 336-2	760315	12015806	81-25934-00

Dimensions

Dimensions

dph-no	dim 1	dim 2	dim 3	Style	Material	dph oil seal no.	Application	Type	OEM-NO	Elring	Corteco	Reinz
36318	155,00	180,00	15,00	A/BS LD W	FPM	81702	crankshaft	VOLVO	821 755-6	760315	12015806	81-25934-00
70480	155,00	180,00	24/29	B SP	FPM	50175	wheel hub	SCANIA	291 463	598925	12011917	
50176	155,00	180,00	24/29	B SP	FPM	50175	wheel hub	SCANIA	370 075	598925	12011917	
82845	156,70	135,00	8/12	special	NBR	82844	crankshaft	BPW	02 5664 58 00		01026187	
114504	158,00	188,00	16,00	KA	FPM	114460	wheel hub	SCANIA	1 528 043			
95208	158,00	188,00	16,00	SP	NBR	95208						
82497	158,00	188,00	14,5/18	KA	FPM	109377	crankshaft	SCANIA	1 363 674	919888	12017426	
110712	158,00	188,00	14,5/18	KA	FPM	109377	crankshaft	SCANIA	130 934-2			
59247	160,00	180,00	9,00	BS	NBR	59247						
47356	160,00	180,00	10,00	B	NBR	68846	front axle	DB	010 997 3046	008818		
47357	160,00	180,00	10,00	A/BS	NBR	94701	front axle	DB	010 997 3146	008672	01019887	
47383	160,00	180,00	10,00	A/B WD	NBR	94702	front axle	DB	011 997 1746		01019888	
47384	160,00	180,00	10,00	A/BS	NBR	94701	front axle	DB	011 997 1846	008672	01019887	
47723	160,00	180,00	10,00	A/BS	NBR	94701	front axle	DB	012 997 1947	008672	01019887	
47724	160,00	180,00	10,00	B	NBR	68846	front axle	DB	012 997 2047	008818	01019888	
80826	160,00	180,00	10,00	A/BS	NBR	94701	front axle	DB	015 997 5747	008672	01019887	
95981	160,00	180,00	10,00	A/B WD	NBR	94702	front axle	DB	015 997 5847	104470	01019888	
51458	160,00	180,00	10,00	A/BS	NBR	94701	front axle	MAN	06 56289 0050	008672	01019887	
35155	160,00	180,00	10,00	A/B WD blue	NBR	94702	front axle	MAN	06 56289 0052		01019888	
113667	160,00	180,00	10,00	A/B WD	NBR	94702	front axle	MAN	06 56289 0365	104470	01019888	
83892	160,00	180,00	10,00	A/BS	NBR	94701	front axle	MAN	06 56289 0366	104480	01019887	
82503	160,00	180,00	15,00	CS	NBR	81835	crankshaft	SAF	4 373 0005 00		01003556	
84414	160,00	185,00	13,00	BS	NBR	18967	crankshaft	DB	010 997 4646		12011376	
114662	160,00	185,00	13,00	BS	NBR	18967	crankshaft	IVECO	4000 1650		12011376	
118921	160,00	185,00	13,00	BS	NBR	18967	crankshaft	IVECO	4000 1653		12011376	
110732	160,00	185,00	13,00	BS	NBR	18967	crankshaft	IVECO	4580 400		12011376	
114663	160,00	185,00	14,00	A WD	ACM	114423	crankshaft	DAF	0259 939		12015609	
118922	160,00	185,00	14,00	A WD	ACM	114423	crankshaft	DAF	0259 940		12015609	
113541	160,00	188,00	14,00	AS W WD SP	NBR	113540	steering	BPW	02 5664 64 57	292660		
119412	160,00	190,00	13,00	AS W LD	PTFE	119412	crankshaft	RENAULT	50 16 295 831			
111398	160,00	190,00	15,00	AS W LD	FPM	111397	crankshaft	DEUTZ	0009 4765			
111397	160,00	190,00	15,00	AS W LD	FPM	111397	crankshaft	DEUTZ	117 5820			
117048	160,00	190,00	15,00	BS WD LA	FPM	112925		DEUTZ	117 5820			
94714	160,00	190,00	15,00	C	NBR	82396	rear axle	MAN	81 96501 0026			
98517	161,92	187,32	12,70	A	NBR	24964	reductor hub	SCANIA	309 113		12012234	

dph-no	dim 1	dim 2	dim 3	Style	Material	dph oil seal no.	Application	Type	OEM-NO	Elring	Corteco	Reinz
114664	164,4/168	188 / 190,00	30 /32	BS WD	ACM	50796	wheel hub	VOLVO	1 591 903	522880	12014351	
37598	164,4/168	188 / 190,00	30 /32	BS WD	ACM	50796	wheel hub	VOLVO	1 610 765			
84628	164,4/168	188 / 190,00	30 /32	BS WD	ACM	50796	wheel hub	VOLVO	944 666-7	522880	12014351	
46966	165,00	190,00	13,00	BS	NBR	47254	rear axle	DB	003 997 4846	346640		
47252	165,00	190,00	13,00	BS	NBR	47254	rear axle	DB	007 997 1846			
47272	165,00	190,00	13,00	BS	NBR	47254	rear axle	DB	007 997 8246	346640	01002772	
47326	165,00	190,00	13,00	BS	NBR	47254	front axle	DB	009 997 1846		01002897	
4500	165,00	190,00	13,00	A blue	NBR	4374	crankshaft	DB	304 997 0447	675407	12011096	
47753	165,00	190,00	13,00	A blue	NBR	4374	front-/rear axle	DB	304 997 1147	675407		
35131	165,00	190,00	13,00	A blue	NBR	4374	fron-/rear axle	MAN	06 56289 0013		12011096	
117363	165,00	190,00	13,00	A blue	NBR	4374	front-/rear axle	MAN	81 96502 0973			
120082	166,00	191,00	16,00	A LD	NBR	120081	crankshaft	DAF	1 684 106			81-37173-00
98342	167,00	188/192,50	30 / 32	BS2 WD SP	FPM	98433	wheel hub	VOLVO	1 610 765	693162		81-35134-00
46905	168,00	190,00	15,00	C LD	NBR	47975		DB	001 997 5346			
4615	170,00	190,00	8,50	AS K	NBR	4045	rear axle	DB	005 997 8447	327247	12012576	
4046	170,00	190,00	8,50	AS K	NBR	4045	rear axle	DB	009 997 8846	327255	12012577	
114665	170,00	190,00	15,00	C	NBR	18976	crankshaft	MAN	06 56289 0143		01003567	
114848	170,00	190,00	15/14	BS blue	NBR	114847	crankshaft	MAN	06 56289 0187		01017575	
35129	170,00	200,00	15,00	C	NBR	18979		MAN	06 56282 1813			
35153	175,00	200,00	15,00	C green	NBR	82397	front-/rear axle	MAN	06 56289 0045			
113539	176,70	155,00	8/12	AS SF	NBR	113538	crankshaft	BPW	02 5664 59 00		01032459	
118515	178,00	205,00	17,00	SP	NBR	118515		New Holland	9967701		19034568	
114856	179,00	200,00	15,5/16,5	KA	FPM	114855	wheel hub	IVECO	4010 2940	456130	12017354	
118924	179,00	200,00	15,5/16,5	KA	FPM	114855	wheel hub	IVECO	4010 2943	456130	12017354	
95055	180,00	200,00	12,00	BS	NBR	82893	crankshaft	IVECO	4000 3720	348376	12011378	
95056	180,00	200,00	12,00	A/B W WD	FPM	81338	rear axle	IVECO	4000 3730	018670	12011326	
111643	180,00	200,00	12,00	BS	NBR	82893	crankshaft	IVECO	4010 0440		12012049	
109745	180,00	200,00	12,00	BS	NBR	82893	crankshaft	IVECO	4010 0443		12012049	
117414	180,00	200,00	12,00	A/B W WD	FPM	81338	wheel hub	IVECO	4010 0670		12014190	
84200	180,00	200,00	12,00	A/B W WD	FPM	81338	wheel hub	IVECO	4010 0673		12014190	
98440	180,00	200,00	12,00	BS	NBR	82893	crankshaft	IVECO	4203 7581	348376	12011378	
113032	180,00	200,00	12,00	B WD	FPM	113031	crankshaft	IVECO	4203 7582	018670	12011326	
117667	180,00	200,00	13,50	KA	NBR	117705	crankshaft	IVECO	4212 7773		12019601	
93617	180,00	200,00	15,00	A	NBR	93617	axle	GORICA				
93618	180,00	200,00	15,00	AS	NBR	93618	axle	GORICA				

Dimensions

dph-no	dim 1	dim 2	dim 3	Style	Material	dph oil seal no.	Application	Type	OEM-NO	Elring	Corteco	Reinz
111639	180,00	200,00	15,00	BS green	NBR	70805	crankshaft	IVECO	4000 0690		12011379	
94369	180,00	200,00	15,00	CS	NBR	70806	crankshaft	SAF	4 373 0006 00		12011379	
117415	180,00	200,00	17,00	A/BS WD	FPM	83906	crankshaft	IVECO	4010 1730		12015265	
83907	180,00	200,00	17,00	AW/BS WD	FPM	83906	crankshaft	IVECO	4010 1733		12015265	
108817	180,00	205,00	15,00	A/BS W	FPM	108818	crankshaft	VOLVO	1 543 896		12015255	81-35206-00
114666	180,00	205,00	15,00	AS W LD	PTFE	114424	crankshaft	VOLVO	20 441 481		20031153	
51729	180,00	224,00	12,00	BO SP	NBR	51729	balance arm bogie	VOLVO	945 538-7			
114667	185,00	206,00	13,00	SP	PTFE	114425		CUMMINS	3082142			
47309	185,00	210,00	13,00	A	NBR	6369	rear axle	DB	009 997 0046	563617	12011099	81-35117-00
47348	185,00	210,00	13,00	A	NBR	6369	rear axle	DB	010 997 0046	563617	12011099	81-35117-00
6477	185,00	210,00	13,00	A blue	NBR	6369	rear axle	DB	304 997 1747	563617	12011099	
119794	190,00	220,00	15,00	AS W	PTFE/ACM	119793		DB	024 997 5047			
35130	190,00	220,00	15,00	C	NBR	93619	axle	MAN	06 56282 2015			
35154	190,00	220,00	15,00	C	NBR	19924		MAN	06 56289 0046			
80799	190,00	220,00	15,00	BS	NBR	80796	crankshaft	STEYR	90 003 070 012		01017008	
81295	190,00	220,00	15,00	BS WD	MVQ	81295	crankshaft	STEYR	90 003 070 012			
80800	190,00	220,00	15,00	B WD	FPM	80797	crankshaft	STEYR	90 003 070 013		01017007	
117364	190,00	220,00	15,00	C	NBR	93619	axle	MAN	85 90001 0001			
61474	195,00	215,00	15,00	A	NBR	61474	axle	GORICA				
35157	200,00	230,00	15,00	C	NBR	18992		MAN	06 56292 0101			



dph-no	dim 1	dim 2	dim 3	Style	Material	dph oil seal no.	Application	Type	OEM-NO	Eling	Corteco	Reinz
47346	145,00	175,00	14,00	BS	NBR	4376	rear axle	DB	009 997 9646	002313		
47376	145,00	175,00	14,00	BS	NBR	4376	rear axle	DB	011 997 0046	002313	12011374	81-91002-00
4440	145,00	175,00	14,00	BS green	NBR	4376	rear axle	DB	011 997 4446	002313	12011374	
46927	26,00	42,00	10,00	AS	NBR	19376	steering	DB	002 997 1946	006297		
46938	26,00	42,00	10,00	AS	NBR	19376	steering	DB	002 997 4346	006297	01019456	
46988	19,60	33,00	8/9	AS	NBR	68850	steering	DB	004 997 1546	006300		
46861	75,00	95,00	10,00	A/B WD	FPM	47938	differential	DB	002 997 7546	006394		
46962	75,00	95,00	10,00	A/B WD	FPM	47938		DB	003 997 3846	006394		
46878	26,00	37,00	7/8	AS V W	NBR	47945	steering	DB	000 997 3946	006408		81-35069-00
46937	26,00	37,00	7/8	AS V W	NBR	47945	steering	DB	002 997 3846	006408	12010865	81-35069-00
46963	26,00	37,00	7/8	AS V W	NBR	47945	steering	DB	003 997 3946	006408		
47571	26,00	37,00	7/8	AS V W	NBR	47945	steering	DB	005 997 3747	006408	12014826	81-35069-00
93878	26,00	37,00	7/8	AS V W	NBR	47945	steering	DB	008 997 9447	006408	12014826	
114553	26,00	37,00	7/8	AS V W	NBR	47945	steering	SCANIA	318 996	006408	12014826	81-35069-00
36627	26,00	37,00	7/8	AS V W	NBR	47945	steering	VOLVO	341 050	006408	12014826	81-35069-00
46972	50,00	72,00	8/10	AS V	NBR	47950	steering	DB	003 997 7246	006432		
69287	50,00	72,00	8/10	AS V	NBR	47950	steering	VOLVO PC	346 381-7	006432		
47450	52,00	72,00	12,00	BS WD	FPM	47951	gearbox	DB	000 997 6647	006564	01002858	
47470	52,00	72,00	12,00	BS WD	FPM	47951	gearbox	DB	001 997 3247	006564		
47472	52,00	72,00	12,00	BS WD	FPM	47951	gearbox	DB	001 997 5047	006564		
46974	52,00	72,00	12,00	BS WD	FPM	47951	gearbox	DB	003 997 7546	006564	01016879	
47665	52,00	72,00	12,00	BS WD	FPM	47951	differential	DB	009 997 6347	006564		
47718	52,00	72,00	12,00	BS WD	FPM	47951	gearbox	DB	011 997 7447	006564	01016879	
47726	52,00	72,00	12,00	BS WD	FPM	47951	gearbox	DB	012 997 2947	006564	01016879	
47243	21,00	33,00	8/9,50	AS V	NBR	36731	steering	DB	006 997 8146	007544		
47398	21,00	33,00	8/9,50	AS blue	NBR	36731	steering	DB	011 997 6746	007544	01019308	
47408	21,00	33,00	8/9,50	AS blue	NBR	36731	steering	DB	011 997 8446	007544		
47244	32,00	44,00	8/9,50	AS	NBR	36730	steering	DB	006 997 8246	007552		
47409	32,00	44,00	8/9,5	AS V	NBR	48045	steering	DB	011 997 8546	007552		
15268	50,00	70,00	10/14	BS2 blue	NBR	59295	front axle	DB	006 997 9646	008028	01016768	81-35292-00
15269	50,00	68,40	10/14,3	BS SP blue	NBR	116341	wheel hub	DB	008 997 9646	008028		
69796	50,00	70,00	10/14	BS2	NBR	59295	front axle	MAN	06 56279 0031	008028	01016768	
112453	50,00	70,00	10/14	BS2	NBR	59295	front axle	MAN	06 56279 0080	008028		
95130	120,00	145,00	15/12	AW BS WD	FPM	95129	rear axle	DB	015 997 9347	008231	01026319	
47313	68,00	90,00	10,00	BS	NBR	95922	rear axle	DB	009 997 0546	008303	01026650	

dph-no	dim 1	dim 2	dim 3	Style	Material	dph oil seal no.	Application	Type	OEM-NO	Eling	Corteco	Reinz
80282	68,00	90,00	12,50	BS	NBR	50346	rear axle	MAN	06 56279 0184	008303	01026650	
47274	80,00	100,00	12,00	BS	NBR	50348	rear axle	DB	007 997 8446	008354	01025712	
47318	80,00	100,00	12,00	BS	NBR	50348	rear axle	DB	009 997 0746	008354	01025712	
47342	80,00	100,00	12,00	BS	NBR	50348	rear axle	DB	009 997 7846	008354		
34633	80,00	100,00	12,00	BS blue	NBR	50348	rear axle	MAN	06 56289 0022	008354		
47286	46,00	68,00	12,00	C	NBR	95185	gearbox	DB	008 997 0246	008362		
47564	75,00	95,00	12,50	BS	NBR	50347	camshaft	DB	005 997 1047	008370		
47566	75,00	95,00	12,50	BS	NBR	50347	camshaft	DB	005 997 1247	008370		
47567	75,00	95,00	12,50	BS	NBR	50347	camshaft	DB	005 997 1847	008370		
47324	75,00	95,00	12,50	BS	NBR	50347	camshaft	DB	009 997 1546	008370	01019460	
48119	75,00	95,00	12,50	BS	NBR	50347	camshaft	MAN	06 56279 0183	008370	01019460	
47302	25,00	35,00	8,00	A D	NBR	47303	steering	DB	008 997 6346	008427		
117330	25,00	35,00	8,00	AD	NBR	47303		MAN	81 96501 0530	008427		
70473	25,00	35,00	8,00	A D	NBR	47303	steering	SCANIA	211 337	008427		
80047	25,00	35,00	8,00	A D	NBR	47303	steering	VOLVO	338 425-2	008427		
47269	68,00	90,00	10/9,50	B WD	FPM	47989	rear axle	DB	007 997 8046	008508		
47312	68,00	90,00	10/9,50	B WD	FPM	47989	rear axle	DB	009 997 0446	008508		
114731	68,00	90,00	10/9,50	B WD	FPM	47989	rear axle	MAN	06 56279 0209	008508		
47331	72,00	105,00	13,00	BS	NBR	4767	front & rear axle	DB	009 997 4546	008559	12012573	
47344	72,00	105,00	13,00	BS	NBR	4767	front&rear axle	DB	009 997 9146	008559	12012573	
47715	72,00	105,00	13,00	BS	NBR	4767	front&rear axle	DB	011 997 7047	008559	12012573	
35110	72,00	105,00	13,00	BS green	NBR	4767	front&rear axle	MAN	06 56279 0028	008559	12012573	
69160	72,00	105,00	13,00	BS	NBR	4767	front&rear axle	MAN	06 56279 0312	008559	12012573	
70527	72,00	105,00	13,00	BS	NBR	4767	front&rear axle	SCANIA	386 967	008559		
36425	64,00	80,00	13,00	AS blue	NBR	61497	front axle	DB	009 997 6647	008591		
36426	64,00	80,00	13,00	AS blue	NBR	61497	front axle	DB	009 997 7546	008591		
47668	64,00	80,00	13,00	AS blue	NBR	61497	front axle	DB	009 997 7547	008591		
47364	64,00	80,00	13,00	AS blue	NBR	61497	front axle	DB	010 997 5546	008591		
69190	64,00	80,00	13,00	AS blue	NBR	61497	front axle	MAN	06 56279 0181	008591	01016769	
47349	57,00	75,00	7,5/6	AS K	NBR	48052	front axle	DB	010 997 1746	008664	01020674	
82931	57,00	75,00	7,5/6	AS K	NBR	48052	front axle	MAN	06 56279 0025	008664	01020674	
47357	160,00	180,00	10,00	A/BS	NBR	94701	front axle	DB	010 997 3146	008672	01019887	
47384	160,00	180,00	10,00	A/BS	NBR	94701	front axle	DB	011 997 1846	008672	01019887	
47723	160,00	180,00	10,00	A/BS	NBR	94701	front axle	DB	012 997 1947	008672	01019887	
80826	160,00	180,00	10,00	A/BS	NBR	94701	front axle	DB	015 997 5747	008672	01019887	

dph-no	dim 1	dim 2	dim 3	Style	Material	dph oil seal no.	Application	Type	OEM-NO	Elring	Corteco	Reinz
51458	160,00	180,00	10,00	A/BS	NBR	94701	front axle	MAN	06 56289 0050	008672	01019887	
47283	85,00	105,00	13,00	B WD	FPM	36789	rear axle	DB	008 997 0046	008680		81-35089-00
47322	85,00	105,00	13,00	B WD	FPM	36789	rear axle	DB	009 997 1246	008680		81-35089-00
36790	85,00	105,00	13,00	B WD	FPM	36789	rear axle	DB	010 997 3646	008680	12012549	81-35089-00
47363	85,00	105,00	13,00	B WD	FPM	36789	rear axle	DB	010 997 5446	008680	12012549	
33421	85,00	105,00	13,00	B WD	FPM	36789	differential	MAN	06 56289 0047	008680		
68551	85,00	105,00	13,00	B WD	FPM	36789	rear axle	MAN	06 56289 0048	008680	12012549	81-35089-00
47360	72,00	105,00	13,00	C WD	FPM	48048	front axle	DB	010 997 3746	008745	12014743	
47362	72,00	105,00	13,00	C WD	FPM	48048	front axle	DB	010 997 5346	008745	12014743	
46636	72,00	105,00	13,00	C WD	FPM	48048	front axle	MAN	06 56279 0073	008745	12014743	
70528	72,00	105,00	13,00	C WD	FPM	48048	transfer gearbox	SCANIA	386 968	008745	12014743	
47356	160,00	180,00	10,00	B	NBR	68846	front axle	DB	010 997 3046	008818		
47724	160,00	180,00	10,00	B	NBR	68846	front axle	DB	012 997 2047	008818	01019888	
47329	50,00	70,00	13,5/8	BS SP	NBR	37350	front axle	DB	009 997 3346	009075	12012696	
47686	50,00	70,00	13,5/8	BS SP	NBR	37350	front axle	DB	010 997 6547	009075	12012696	
47687	50,00	70,00	13,5/8	BS SP	NBR	37350	front axle	DB	010 997 6647	009075	12012696	
37351	50,00	70,00	13,5/8	BS SP	NBR	37350	front axle	DB	010 997 6747	009075	12012696	
47396	50,00	70,00	13,5/8	BS SP	NBR	37350	front axle	DB	011 997 5146	009075		
47712	50,00	70,00	13,5/8	BS SP	NBR	37350	front axle	DB	011 997 5547	009075	12012696	
4071	50,00	70,00	13,5/8	BS SP	NBR	37350	front axle	DB	011 997 6046	009075	12012696	
84203	50,00	70,00	13,5/8	BS SP	NBR	37350	front axle	DB	019 997 0847	009075		
96174	135,00	175,00	18,00	KA/BS SP	FPM/NBR	96648	wheel hub	MAN	81 96503 0188	009310	12020157	
4074	72,00	85,60	18,00	B blue	NBR	70313	front axle	DB	005 997 1646	009360	16011841	
47480	42,00	58,00	7,00	BS	NBR	37347	rear axle	DB	001 997 8047	010197		
4542	42,00	58,00	7,00	BS	NBR	37347	rear axle	DB	003 997 0547	010197	01017010	
48050	42,00	58,00	7,00	BS	NBR	37347	rear axle	DB	009 997 3046	010197		
47416	42,00	58,00	7,00	BS	NBR	37347	rear axle	DB	350 997 7346	010197		
80281	42,00	58,00	7,00	BS	NBR	37347	rear axle	MAN	06 56279 0114	010197		
35264	42,00	58,00	7,00	BS	NBR	37347	rear axle	MAN	06 56279 0133	010197		
84198	42,00	58,00	7,00	BS	NBR	37347	rear axle	MAN	81 96501 0843	010197		
46980	10,00	15,00	3,00	B OF	NBR	47952	front axle	DB	003 997 9846	010804	01002259	81-25545-00
114516	10,00	15,00	3,00	B OF	NBR	47952	front axle	MAN	06 56269 0479	010804	01002259	
114517	10,00	15,00	3,00	B OF	NBR	47952	front axle	MAN	06 56269 0527	010804	01002259	
96085	10,00	15,00	3,00	B OF	NBR	47952	front axle	VOLVO	346 822-0	010804	01002259	
47488	120,00	150,00	15/12	CS	NBR	48002	front axle	DB	002 997 1847	010901		81-35103-00

dph-no	dim 1	dim 2	dim 3	Style	Material	dph oil seal no.	Application	Type	OEM-NO	Elring	Corteco	Reinz
47489	120,00	150,00	15/12	CS	NBR	48002	front axle	DB	002 997 1947	010901		
47490	120,00	150,00	15/12	CS	NBR	48002	front axle	DB	002 997 2047	010901		81-35103-00
47541	120,00	150,00	15/12	CS	NBR	48002	front axle	DB	004 997 1747	010901	12011418	81-35103-00
47542	120,00	150,00	15/12	CS	NBR	48002	front axle	DB	004 997 1847	010901	12011418	81-35103-00
116035	10,00	18,00	6,00	A	NBR	17356	crankshaft	BMW	23 12 1 451 030	011304		
33259	10,00	18,00	6,00	A	NBR	17356	crankshaft	BMW	23 12 1 451 157	011304		
110504	85,00	131/152	15,70	KA	PTFE	120201	crankshaft	VW	06A 103 171 B / D	012370	20020383	81-90010-00
94797	70,00	90,00	13,5/14,50	SP	FPM	95465	crankshaft	IVECO	4010 2273	013930	12015793	
97822	154,00	180,00	12,00	A/BS LD	AEM/PTFE	115386	crankshaft	DAF	1340 320	017590	20029771	81-28539-00
95056	180,00	200,00	12,00	A/B W WD	FPM	81338	rear axle	IVECO	4000 3730	018670	12011326	
113032	180,00	200,00	12,00	B WD	FPM	113031	crankshaft	IVECO	4203 7582	018670	12011326	
15261	72,00	84/85,6	18,00	BS	NBR	48057	rear axle	DB	011 997 0646	018813	16011841	
47743	115,00	140,00	13,00	A	NBR	18885	rear axle	DB	303 997 0647	019364		
117311	30,00	44,00	7,00	AS RD	NBR	104536	crankshaft	MAZDA	B630-10-602	022160		81-53228-00
117310	34,00	48,00	7,00	AS RD	MVQ	104534	crankshaft	MAZDA	F801-10-602	022170		81-53243-00
84199	125,00	150,00	13,00	CS	NBR	81334	crankshaft	IVECO	4000 1933	022560	12011419	
95654	145,00	175,00	17/21	A/BS2 WD SP	FPM	95653	wheel hub	DB	020 997 3947	022850	01019352	81-35223-00
84170	48,00	65,00	10,00	AW/BS RD F	FPM	36203	crankshaft	BMW	11 14 1 265 431	022918	12012045	
109854	72,00	105,00	19,00	SP	FPM/ACM	109858	differential	DB	020 997 0647	023330	01026188	
114049	33,00	47,00	5,00	AS W RD	FPM	114098	crankshaft	FORD	1 112 945	023590	15510081	
114050	35,00	50,00	8,00	A RD SP	ACM/PTFE	114092	crankshaft	FORD	1 119 162	023630	20034565	81-35551-00
114058	27,00	47,00	7,00	AS W RD	ACM/PTFE	114095	camshaft	FORD	1 145 953	026740	20029115	81-35552-00
114056	40,00	55,00	6,40	AS W RD	ACM/PTFE	114093	crankshaft	FORD	1 142 359	026750	20029116	81-35554-00
114051	30,00	50,00	7,50	AS W RD	ACM/PTFE	114096	crankshaft	FORD	1 198 045	026770	20029769	
114053	50,00	90,00	14,00	SP	PTFE	114097	crankshaft	FORD	1 230 867	026780		81-90014-00
114057	85,00	105,00	8,80	AS W LD	ACM/PTFE	114094	crankshaft	FORD	1 142 360	026790	20029117	81-35553-00
47524	62,00	80,00	10,00	B	NBR	18528	crankshaft	DB	003 997 5947	028436		
83894	62,00	80,00	10,00	BS LD	ACM	81351	crankshaft	IVECO	4000 0283	028436	12011433	
47504	60,00	80,00	8,00	A	NBR	18489	crankshaft	DB	002 997 7147	029335		
47389	145,00	175,00	13,00	C	FPM	97801	axle	DB	011 997 3146	033146		
47392	145,00	175,00	13,00	C	FPM	97801	axle	DB	011 997 3846	033146		
84522	145,00	175,00	13,00	C	FPM	34644	rear axle	MAN	06 56289 0066	033146		
34645	145,00	175,00	13,00	C	FPM	34644	rear axle	MAN	06 56289 0145	033146		
109841	145,00	175,00	13,00	C	FPM	97801	wheel hub	MAN	81 96501 0860	033146	12015499	
47967	68,00	90,00	13,00	BS RD	FPM	47947	differential	DB	000 997 4446	033171		81-35083-00

dph-no	dim 1	dim 2	dim 3	Style	Material	dph oil seal no.	Application	Type	OEM-NO	Eling	Corteco	Reinz
50874	115,00	140,00	16,00	BS LA LD	FPM	48305	crankshaft	DEUTZ	223 4134	033376	12012148	
51674	115,00	140,00	16,00	BS LA LD	FPM	48305	crankshaft	DEUTZ	415 0783	033376	12012148	81-20481-20
119131	115,00	140,00	16,00	BS LA LD	FPM	48305	crankshaft	DEUTZ	415 2349	033376	12012148	
94524	115,00	140,00	16,00	BS LA LD	FPM	48305	crankshaft	DEUTZ	423 0193	033376		
82331	115,00	140,00	16,00	BS LA LD	FPM	48305	crankshaft	DEUTZ	423 0392	033376	12012148	
112514	115,00	140,00	13,50	AS LD	FPM/ACM	115617	crankshaft	DEUTZ	423 2267	033377	20020387	81-20481-30
81014	65,00	85,00	13/12,5	BS RD LA SP	FPM	93422	crankshaft	DEUTZ	415 0782	033457	12012095	81-21527-20
94264	65,00	85,00	13/12,5	BS RD LA SP	FPM	93422	crankshaft	DEUTZ	415 2348	033457		
112374	68,00	85,00	10,50	AS W RD	FPM/ACM	80375	BF6L913, BF6L912	DEUTZ	423 2266	033459	20020386	81-21527-30
111583	85,00	105,00	10,00	AW/BS LD	FPM	82528	gearbox	DAF	0140 783	033464	12013757	
114766	85,00	105,00	10,00	AW/BS LD	FPM	82528	gearbox	DAF	0609 475	033464	12013757	
114767	85,00	105,00	10,00	AW/BS LD	FPM	82528	gearbox	DAF	0693 928	033464	12013757	
47536	85,00	105,00	10,00	B LD	FPM	4047	gearbox	DB	004 997 0647	033464	12013757	
46989	85,00	105,00	10,00	B LD	FPM	4047	gearbox	DB	004 997 2246	033464	12013757	
47597	85,00	105,00	10,00	B LD	FPM	4047	gearbox	DB	006 997 4147	033464		
4048	85,00	105,00	10,00	B LD	FPM	4047	gearbox	DB	006 997 7046	033464		
47605	85,00	105,00	10,00	B LD	FPM	4047	gearbox	DB	006 997 8647	033464		
36791	85,00	105,00	10,00	B LD	FPM	4047	gearbox	DB	007 997 5947	033464	12013757	
47648	85,00	105,00	10,00	B LD	FPM	4047	gearbox	DB	008 997 3347	033464	12013757	
4646	85,00	105,00	10,00	B LD	FPM	4047	gearbox	DB	012 997 0647	033464	12013757	
112542	85,00	105,00	10,00	B LD	FPM	4047	gearbox	IVECO	4248 5827	033464	12013757	
114768	85,00	105,00	10,00	AW/BS LD	FPM	82528	gearbox	MAN	06 56289 0067	033464	12013757	
50681	85,00	105,00	10,00	B LD	FPM	4047	gearbox	MAN	81 96502 0208	033464	12013757	
84618	48,00	75,00	8,00	B RD	FPM	4545	gearbox	DAF	0110 466	033472	12011307	
114671	48,00	75,00	8,00	B RD	FPM	4545	gearbox	DAF	0609 458	033472	12011307	
47537	48,00	75,00	8,00	B RD	FPM	4545	gearbox	DB	004 997 0747	033472	12011307	
47606	48,00	75,00	8,00	B RD	FPM	4545	gearbox	DB	006 997 8747	033472		
4441	48,00	75,00	8,00	B RD brown	FPM	4545	gearbox	DB	007 997 5447	033472	12011307	
47651	48,00	75,00	8,00	B RD	FPM	4545	gearbox	DB	008 997 3847	033472	12011307	
47374	48,00	75,00	8,00	B RD	FPM	4545	gearbox	DB	010 997 9246	033472		
114672	48,00	75,00	8,00	B RD	FPM	4545	gearbox	MAN	06 56279 0084	033472	12011307	
93757	48,00	75,00	8,00	B RD	FPM	4545	gearbox	MAN	81 96502 0225	033472	12011307	
111581	85,00	105,00	12/10	B	NBR	95872	gearbox	DAF	0585 373	033480	12011341	81-35091-00
47607	85,00	105,00	12,00	B	NBR	44329	gearbox	DB	006 997 8847	033480		
47719	85,00	105,00	12,00	B	NBR	44329	gearbox	DB	011 997 8547	033480	12011341	81-35091-00

180

dph-no	dim 1	dim 2	dim 3	Style	Material	dph oil seal no.	Application	Type	OEM-NO	Eling	Corteco	Reinz
3903	78,00	100,00	10,00	A LD	MVQ	3902	crankshaft	PEUGEOT	0514 14	034347		81-23578-00
46910	14,00	24,00	7,00	B	NBR	19033	gearbox	DB	001 997 8346	037109	01002369	
48065	14,00	24,00	7,00	B	NBR	19033		DB	003760 014200	037109		
47572	14,00	24,00	7,00	B	NBR	19033		DB	005 997 4247	037109		
117302	14,00	24,00	7,00	B	NBR	19033		MAN	06 56261 0804	037109		
35207	14,00	24,00	7,00	B	NBR	19033		MAN	81 96501 0313	037109		
33283	15,00	24,00	7,00	B	NBR	17404	manual gearbox	DB	001 997 2946	037133	12010790	
47308	15,00	24,00	7,00	B	NBR	17404	manual gearbox	DB	008 997 9846	037133	01002376	
33352	15,00	24,00	7,00	B	NBR	17404	manual gearbox	PORSCHE	900 112 00150	037133		
47028	20,00	32,00	7,00	BABSL	NBR	51422	steering	DB	005 997 5846	037524	12010824	
97892	20,00	32,00	7,00	BABSL	NBR	51422	steering	ZF	0634 302 121	037524		
114548	22,00	40,00	10,00	A	NBR	17567	crankshaft	MAN	06 56260 1408	037850	12010838	
47492	25,00	35,00	7,00	AS	NBR	84590	injection pump	DB	002 997 2747	038075		
47347	25,00	35,00	7,00	AS	NBR	84590	injection pump	DB	009 997 9746	038075	12011122	
47395	25,00	35,00	7,00	AS	NBR	84590	injection pump	DB	011 997 4746	038075	12011122	
70465	25,00	35,00	7,00	AS	NBR	84590	injection pump	SCANIA	192 600	038075	12011122	
81848	25,00	35,00	7,00	AS	NBR	84590	injection pump	VOLVO	240 022	038075	12011122	
111591	25,00	35,00	7,00	B	NBR	4378	gearbox	DAF	0140 335	038083	12014616	
47240	25,00	35,00	7,00	B	NBR	4378	gearbox	DB	006 997 4946	038083	12014616	
117303	25,00	35,00	7,00	B	NBR	4378	gearbox	MAN	06 56261 1609	038083	12014616	81-35123-00
35212	25,00	35,00	7,00	B	NBR	4378	gearbox	MAN	81 96501 0521	038083	12014616	
70475	25,00	35,00	7,00	B	NBR	4378	gearbox	SCANIA	254 635	038083	12014487	
119406	25,00	35,00	7,00	B	NBR	4378	gearbox	VOLVO	6 876 348-1	038083	12014616	
46860	25,00	40,00	8,00	AS DUO	NBR	80977	gearbox	DB	002 997 7446	038164		
47023	25,00	40,00	8,00	AS DUO	NBR	80977	gearbox	DB	005 997 4846	038164		
117394	25,00	40,00	7,00	AS	NBR	17615	steering	IVECO	767 775	038164	12011123	
46845	25,00	42,00	10,00	BS	NBR	19987		DB	000 997 2245	038229		
84622	25,00	47,00	10,00	A	NBR	68544	crankshaft	DAF	0119 198	038326	12010859	
70457	25,00	47,00	10,00	A	NBR	68544	crankshaft	SCANIA	170 761	038326	12010858	81-20553-10
47482	25,00	52,00	7,00	B	NBR	17653	crankshaft	DB	001 997 8547	038385	01002458	
35090	25,00	52,00	7,00	B	NBR	17653	crankshaft	MAN	06 56261 1615	038385	01002458	
4502	26,00	45,00	10,00	B blue	NBR	4442	injection	DB	003 997 4046	038490	12011330	81-20308-00
80376	28,00	47,00	10,00	B	NBR	19153	rear axle	DB	000 997 7547	038660	01002474	81-20307-00
46946	30,00	40,00	7,00	AS	NBR	17725		DB	002 997 6146	038806		
46998	30,00	40,00	7,00	AS	NBR	17725	crankshaft	DB	004 997 6246	038806	12011131	

181

dph-no	dim 1	dim 2	dim 3	Style	Material	dph oil seal no.	Application	Type	OEM-NO	Eling	Corteco	Reinz
47306	30,00	40,00	7,00	B	NBR	6451	crankshaft	DB	008 997 7346	038814		
47666	30,00	40,00	7,00	B	NBR	6451	crankshaft	DB	009 997 6447	038814		
4716	30,00	40,00	7,00	B blue	NBR	6451	crankshaft	MAN	06 56261 1911	038814		
46977	30,00	42,00	7,00	B	NBR	17729		DB	003 997 8546	038865		
46993	30,00	47,00	8,00	B	NBR	36748	gearbox	DB	004 997 3246	038873		
47557	30,00	47,00	8,00	B	NBR	36748	gearbox	DB	004 997 7547	038873		
47577	30,00	47,00	8,00	B	NBR	36748	gearbox	DB	005 997 6047	038873		
47587	30,00	47,00	8,00	B	NBR	36748	gearbox	DB	005 997 8647	038873	01002484	
95589	30,00	48,00	10,00	A RD	ACM	95588	gearbox	BMW	23 12 1 204 211	038938		81-35284-00
116036	30,00	48,00	10,00	A RD	ACM	95588	gearbox	BMW	23 12 1 606 122	038938		
116037	30,00	48,00	10,00	A RD	ACM	95588	gearbox	BMW	23 12 1 606 123	038938		
33255	38,00	52,00	10,00	B blue	NBR	51486	manual transmission	BMW	23 12 1 201 390	039780		
46855	38,00	52,00	10,00	B	NBR	51486	gearbox	DB	000 997 1746	039780		
47287	38,00	52,00	10,00	B	NBR	51486	gearbox	DB	008 997 0446	039780		
15266	38,00	52,00	10,00	B	NBR	51486	gearbox	DB	008 997 3346	039780	12011499	
47431	40,00	52,00	7,00	B	NBR	68543	gearbox	DB	000 997 0747	039918		
47427	40,00	52,00	7,00	B	NBR	68543	gearbox	DB	608 997 1246	039918		
114581	40,00	52,00	7,00	B	NBR	68543	gearbox	DEUTZ	121 6330	039918		
116039	40,00	52,00	7,00	BS	NBR	37345	front axle	BMW	31 21 1 106 225	039926		
116040	40,00	52,00	7,00	BS	NBR	37345	front axle	BMW	31 21 1 106 226	039926		
116041	40,00	52,00	7,00	BS	NBR	37345	front axle	BMW	31 21 1 106 227	039926		
47727	40,00	55,00	8,00	AS	NBR	18078	wheel hub	DB	012 997 3847	039993	12011157	
4062	40,00	55,00	8,00	AS	NBR	18078	wheel hub	FORD	1 482 324	039993	12011157	
33296	40,00	55,00	8,00	AS	NBR	18078	wheel hub	FORD	1 579 665	039993	12011157	
116121	42,00	58,00	7,00	BS	NBR	37347	rear axle	BMW	33 41 1 106 213	040304		
4063	42,00	58,00	7,00	BS	NBR	37347	rear axle	BMW	33 41 3 404 161	040304	12012129	
46955	42,00	60,00	10,00	A	NBR	18168	crankshaft	DB	003 997 1646	040320	12010944	
47279	42,00	60,00	10,00	B	NBR	18169		DB	007 997 8946	040339		
35211	42,00	60,00	10,00	B	NBR	18169		MAN	81 96501 0448	040339		
114585	42,00	62,00	10,00	A	NBR	18175	wheel hub	MAN	06 56279 0035	040355	12010946	
3898	42,00	62,00	10,00	A	NBR	18175	wheel hub	PEUGEOT	3724 08	040355	12011236	
114586	42,00	62,00	10,00	AS RD	ACM	35050	crankshaft	PEUGEOT	0514 21	040363	12013896	81-21001-10
114587	42,00	62,00	10,00	AS RD	ACM	35050	crankshaft	RENAULT	79 10 247 576	040363	12013896	
33552	42,00	62,00	10,00	AS RD	ACM	35050	crankshaft	VOLVO PC	1 218 034	040363	12013896	
35051	42,00	62,00	10,00	AS RD	ACM	35050	crankshaft	VW	021 105 247 A	040363	12013896	81-21001-10

dph-no	dim 1	dim 2	dim 3	Style	Material	dph oil seal no.	Application	Type	OEM-NO	Eling	Corteco	Reinz
35511	42,00	62,00	10,00	AS RD	ACM	35050	crankshaft	VW	021 105 247 B	040363	12013896	81-21001-10
68810	45,00	60,00	7,00	A	NBR	70213	crankshaft	SCANIA	120 828	040606	12010950	
116113	45,00	62,00	7,00	BS	NBR	37346	front axle	BMW	31 21 1 106 220	040673		
4065	45,00	62,00	7,00	BS	NBR	37346	front axle	BMW	31 21 2 634 108	040673		
116114	45,00	62,00	7,00	BS	NBR	37346	front axle	BMW	32 21 2 634 108	040673		
46856	45,00	65,00	10,00	B	NBR	51487	gearbox	DB	000 997 1846	040843		
114600	45,00	65,00	10,00	B	NBR	51487	gearbox	MAN	06 56279 0003	040843	12011509	
109165	48,00	65,00	10,00	B	NBR	81637	gearbox	DAF	0586 697	040991	12011331	
47436	48,00	65,00	10,00	B	NBR	81637	gearbox	DB	000 997 2147	040991		
47615	48,00	65,00	10,00	B	NBR	81637	gearbox	DB	007 997 2147	040991	12011331	
47333	48,00	65,00	10,00	B	NBR	81637	gearbox	DB	009 997 4746	040991		
35115	48,00	65,00	10,00	B green	NBR	81637	gearbox	MAN	06 56279 0042	040991	12011331	
34634	48,00	65,00	10,00	B green	NBR	81637	gearbox	MAN	81 96502 0248	040991	12011331	
114606	48,00	65,00	10,00	B	NBR	81637	gearbox	RENAULT	77 01 014 157	040991	12011331	
114607	48,00	65,00	10,00	B	NBR	81637	gearbox	VOLVO	6 857 279-1	040991	12011331	
108799	48,00	65,00	10,00	B	NBR	81637	gearbox	VOLVO	6 876 127-9	040991	12011331	
47375	50,00	65,00	8,00	B	NBR	18316	wheel hub	DB	010 997 9646	041114	01020676	
15267	50,00	65,00	8,00	B	NBR	18316	wheel hub	DB	010 997 9746	041114		
35092	50,00	65,00	8,00	B	NBR	18316	wheel hub	MAN	06 56271 0807	041114		
117369	50,00	65,00	10,00	B	NBR	116340	wheel hub	MAN	06 56279 0138	041114	01020676	81-35124-00
46986	55,00	75,00	10/8	B	NBR	50345	gearbox	DB	004 997 0946	041335	12011333	81-20991-20
47745	60,00	80,00	10,00	A	NBR	81629	crankshaft	DB	303 997 0947	041491	12010999	
93582	60,00	80,00	10,00	A	NBR	81629	crankshaft	PORSCHE	999 113 02950	041491		81-17085-00
34918	60,00	80,00	10,00	A blue	NBR	81629	crankshaft	VW	111 105 245	041491		
47645	60,00	80,00	10,00	C	NBR	51483	rear axle	DB	008 997 2947	041513		
35097	60,00	80,00	10,00	C green	NBR	51483	front axle	MAN	06 56272 1312	041513		
82211	60,00	85,00	10,00	B	NBR	47466	differential	DB	002 997 7646	041599	12011334	
81485	70,00	90,00	10,00	A LD	ACM	81487	crankshaft	VW	113 105 245 F	042102	12001482	81-15287-30
35109	70,00	90,00	13,00	C	NBR	18619		MAN	06 56279 0019	042161		
47037	80,00	100,00	10,00	B	NBR	18683	gearbox	DB	005 997 9746	042390		
70474	80,00	100,00	10,00	B	NBR	18683	gearbox	SCANIA	216 608	042390		
47035	80,00	100,00	12,00	B	FPM	47315		DB	005 997 9646	042420		
47616	80,00	100,00	12,00	B	FPM	47315		DB	007 997 3847	042420		
47618	80,00	100,00	12,00	B	FPM	47315		DB	007 997 4947	042420		
47317	80,00	100,00	12,00	B	FPM	47315		DB	009 997 0646	042420		

dph-no	dim 1	dim 2	dim 3	Style	Material	dph oil seal no.	Application	Type	OEM-NO	Eling	Corteco	Reinz
80482	80,00	100,00	12,00	B	FPM	47315	crankshaft	MAN	06 56289 0191	042420		
94928	80,00	100,00	13,00	BS blue	NBR	94928	rear axle	SCANIA	124 268	042463		
34671	90,00	120,00	13,00	C green	NBR	51722	rear axle	DB	006 997 0446	042617	12011413	81-35149-00
80389	95,00	120,00	12,00	AS RD	ACM	68547	crankshaft	DEUTZ	116 3316	042676		81-22228-00
47241	95,00	120,00	13,00	C	NBR	51723	rear axle	DB	006 997 6946	042684	12011398	81-35093-00
114613	95,00	120,00	13,00	C	NBR	51723	rear axle	MAN	06 56289 0111	042684	12011398	81-35093-00
46876	95,00	125,00	13,00	CS	NBR	82785	front axle	DB	000 997 3446	042714	12011399	
47521	95,00	130,00	13,00	C	NBR	18810	front axle	DB	003 997 4047	042714	12011399	
50868	44,50	62,00	10/7	AS2 WD	NBR	95590	rear axle	VW	113 501 315 H	042803	12011164	
35021	105,00	130,00	13,00	C	NBR	18846	front axle	DB	000 997 6447	042846	12011403	81-35098-00
114629	105,00	130,00	13,00	C	NBR	18846	front axle	MAN	06 56289 0113	042846	12011403	81-35098-00
109678	120,00	140,00	13,00	C	NBR	94015	crankshaft	SAF	4 373 0003 00	042935	12012064	
18904	120,00	150,00	15,00	C	NBR	18904	front axle	MAN	06 56289 0221	042943		
80241	150,00	172,00	18,00	AT W LD	MVQ	68548	crankshaft	DEUTZ	116 0383	043095		81-21395-10
50682	45,00	62,00	10,00	CS	NBR	18227	wheel hub	VW	477 405 641	043451		
110482	22,20	40,00	12/17	AS RD	ACM	4042	gearbox	VW	113 311 113	043605		
4041	22,00	40,00	12/17	AS RD	ACM	4042	gearbox	VW	113 311 113 A	043605		
84614	80,00	95,00	8,00	A	NBR	35192	crankshaft	DAF	0010 588	043737	07013486	81-35088-00
114759	80,00	95,00	8,00	A W WD	NBR	113981	wheel accessory kit	VOLVO	947 269-7	043737	07013486	
4061	40,00	52/62,00	8,50	AW SP	NBR	51455	front & rear axle	OPEL	328 637	043923	12011155	81-31435-00
32871	58,00	75,00	12,00	C blue	NBR	50807	gearbox	DB	008 997 1146	043932	01003273	
80579	45,00	68/72,20	19,50	SP	MVQ	80578	gearbox automatic	VW	001 301 083	043958		
47459	140,00	165,00	12/15	AS2W WD	FPM	47979	front axle	DB	001 997 0547	043990		
47549	140,00	165,00	12/15	AS2W WD	FPM	47979	front axle	DB	004 997 5947	043990		
47574	140,00	165,00	12/15	AS2W WD	FPM	47979	front axle	DB	005 997 4547	043990		
47595	140,00	165,00	12/15	AS2W WD	FPM	47979	front axle	DB	006 997 3147	043990		
34919	16,00	24,00	7,00	A	NBR	17428	transfer gearbox	VW	311 415 277	044008		
47477	40,00	55,00	10,00	B	NBR	18082	transfer gearbox	DB	001 997 7347	044318		
3913	40,00	55,00	10,00	B	NBR	18082	transfer gearbox	DB	005 997 2046	044318		
36121	40,00	55,00	10,00	B	NBR	18082	transfer gearbox	DB	005 997 8747	044318	01002552	
46981	45,00	62/68,00	10/8	AS BD	NBR	47953	wheel hub	DB	004 997 0146	044369		81-35288-00
46982	45,00	62/68,00	10/8	AS BD	NBR	47953	wheel hub	DB	004 997 0446	044369		81-35288-00
47005	45,00	62/68,00	10/8	AS BD	NBR	47953	wheel hub	DB	004 997 8146	044369		
46951	90,00	112,70	13,00	C	NBR	50803	rear axle	DB	002 997 6846	044571	12011397	81-33850-00
4292	92,00	110,00	7,00	AS LD W	FPM	49103	crankshaft	VOLVO PC	6 842 093-4	044590	12017124	

dph-no	dim 1	dim 2	dim 3	Style	Material	dph oil seal no.	Application	Type	OEM-NO	Eling	Corteco	Reinz
33548	92,00	110,00	10,00	AS LD W	MVQ	16051	crankshaft	VOLVO PC	430 118-0	044598	12013897	81-25583-00
82335	104,00	130,00	15/33	B SP	NBR	82334	wheel hub	DEUTZ	342 7559	044636		
46846	115,00	150,00	13,00	C	NBR	18892	rear axle	DB	004 997 7745	044660	12003475	
47299	115,00	150,00	13,00	C	NBR	18892	rear axle	DB	008 997 6046	044660		
47010	120,00	145,00	15/12	C	NBR	50805	rear axle	DB	005 997 0346	044679		81-35106-00
47038	120,00	145,00	15,00	C	NBR	43207	rear axle	DB	006 997 0546	044679	12011405	81-35106-00
46879	125,00	152,40	15,00	CS	NBR	94589	rear axle	DB	000 997 4046	044687	12011406	81-35107-00
47471	125,00	152,40	15,00	CS	NBR	94589	rear axle	DB	001 997 3847	044687	12011406	81-35107-00
33377	125,00	152,40	15,00	CS	NBR	94589	rear axle	DB	002 997 4046	044687	12011406	
37513	42,00	67,00	17,60	AS WD	NBR	37512	gearbox	VW	002 301 189 C	045322		
4060	40,00	52/58,00	7,5/6	AS WD W	NBR	37227	rear axle	VW	321 501 641	045772	12011153	
111534	65,00	85,00	10,00	AS2 WD	NBR	111533	wheel hub	VW	291 501 317	046094	12013927	
46930	34,00	52,00	8,00	A	NBR	17888	front axle	DB	002 997 2046	048364		
47297	34,00	52,00	8,00	A	NBR	17888	automatic gearbox	DB	008 997 2546	048364		
34036	34,00	52,00	8,00	A	NBR	17888	automatic gearbox	DB	008 997 9146	048364	01010901	
3896	45,00	60,00	10,00	A	NBR	18215	wheel hub	PEUGEOT	3724 18	048410	12010951	
47011	55,00	80,00	10/12	AS	NBR	80530	crankshaft	DB	005 997 0946	048437	12010986	
37636	26,00	42,00	8,00	AS RD	MVQ	37636	crankshaft	OPEL	646 262	049557		81-24911-00
114670	48,00	65,00	10,00	AS W RD	AEM/PTFE	114341	crankshaft	BMW	11 14 2 247 117	050260	20019549	
96713	48,00	65,00	10,00	AS W RD	AEM/PTFE	114341	crankshaft	BMW	11 14 2 249 532	050260	20019549	81-17404-10
114521	17,00	28,00	7,00	AS	NBR	17448	crankshaft	DAF	0119 468	050300	12011112	
47007	17,00	28,00	7,00	A	NBR	17447	crankshaft	DB	004 997 8546	050300	01210807	
114520	17,00	28,00	7,00	A	NBR	17447	crankshaft	MAN	06 56260 1106	050300	12010807	
115412	27,95	56,00	10,00	ASW RD	ACM	115411	differential	RENAULT	77 03 087 146	050560	07011906	
47515	105,00	130,00	12,00	AW/BS RD vlies	FPM	112532	crankshaft	DB	003 997 1347	052492		
46941	19,60	33,00	9,00	AS	NBR	47942	water pump	DB	002 997 4846	054003		
46866	17,00	35,00	7,00	A	NBR	93613	water pump	DB	002 997 8446	054003	12010810	81-17193-00
47561	17,00	35,00	7,00	A	NBR	93613	water pump	DB	005 997 0147	054003	12010810	
114522	17,00	37,00	10,00	A	NBR	68546		DEUTZ	121 6338	055506		
96434	87,00	100,00	8,50	AS LD	FPM	97874	crankshaft	OPEL	614 825	060110	12015429	81-53299-00
94863	40,00	52,00	6,00	AS RD	FPM	94862	crankshaft	OPEL	614 822	060120	12015430	
113044	66,00	90,00	12,00	SP	PTFE	114371	crankshaft	MAN	51 01510 0219	061680	15027677	81-27522-10
61261	45,00	60,00	8,00	AS W WD	ACM	61260	gearbox	VW	018 409 399	063665	12017270	
70818	45,00	60,00	8,00	AS WD W	ACM	61260	gearbox	VW	088 409 399 D	063665		
112249	85,00	145,00	12/32	SP	FPM	114402	differential	DB	018 997 1847	065510	01030110	

dph-no	dim 1	dim 2	dim 3	Style	Material	dph oil seal no.	Application	Type	OEM-NO	Eling	Corteco	Reinz
111789	31,00	41,00	7,00	A/BS RD	FPM	111788	crankshaft	FIAT	762 8850	069590	12018321	81-35882-00
114612	95,00	120,00	13,00	BS LD	FPM	82399	crankshaft	IVECO	4000 0720	071570	12011314	
109072	28,00	42,00	5,00	AS RD	FPM	109071	camshaft	RENAULT	77 01 471 376	073890	12018754	81-34408-00
47018	22,00	32,00	7/8	AS	NBR	48039	gearbox	DB	005 997 3546	075175		
96384	27,00	42,00	8,00	A/BS RD	FPM	96387	camshaft	VW	036 103 085 A	076110	12018554	81-34226-00
96680	130,00	150,00	13,00	AS LD FILZ	FPM/ACM	96235	crankshaft	DEUTZ	425 3333	084610	01027763	81-36001-00
114746	74,00	95,00	11,00	AW/BS RD F	FPM	110391	crankshaft 1012	DEUTZ	425 3372	084790	01027764	81-36021-00
96681	81,00	104,00	11,00	AW/BS RD V	FPM	96231	oil pump	DEUTZ	425 3373	084920	01027762	81-35999-00
94832	15,00	24,00	7,00	A	FPM	20500		PORSCHE	999 113 18540	089613		
47596	120,00	140,00	13,00	AW/BS LD	FPM	112531	crankshaft	DB	006 997 3347	090158	12014877	
47256	120,00	140,00	13,00	AW/BS LD	FPM	112531	crankshaft	DB	007 997 2446	090158	12014877	
36178	120,00	140,00	13,00	AW/BS LD	FPM	112531	crankshaft	MAN	51 01510 0133	090158	12014877	
111452	145,00	175,00	13,00	AS LD SF	PTFE	111451	crankshaft	SCANIA	1 375 002	090510	15026917	81-35996-00
111453	145,00	175,00	13,00	AS LD SF	PTFE	111451	crankshaft	SCANIA	1 433 183	090510	15026917	81-35996-00
84231	45,00	62,00	6,5/7	A/B WD	ACM	84230	gearbox	VW	087 409 529 B	091511	01026543	
70571	20,00	35,00	7/10	AS RD	ACM	70816	gearbox	VW	014 311 113 A	091626		
47288	52,00	72,00	12,00	BS	NBR	35095	gearbox	DB	008 997 0546	091901		
35094	52,00	72,00	12,00	BS	NBR	35095	differential	MAN	06 56272 0047	091901		
35116	52,00	72,00	12,00	BS	NBR	35095	differential	MAN	06 56279 0047	091901		
117336	22,00	35,00	7,00	A LD	MVQ	94526	crankshaft	MAN	81 96501 0859	092614		
4056	40,00	52,00	9,00	AS W WD	ACM	70817	gearbox	VW	014 409 399 D	094358	12010684	
84216	44,00	67,00	10,00	AS WD	ACM	84215	differential	BMW	33 13 1 206 111	095311	01020317	
93723	44,00	67,00	10,00	AS WD	ACM	84215	differential	BMW	33 13 1 214 100	095311	01020317	81-29411-00
47282	85,00	105,00	13,00	BS	NBR	32425	gearbox	DB	007 997 9946	096067	12011359	81-35092-00
6550	85,00	105,00	13,00	BS blue	NBR	32425	gearbox	DB	009 997 1146	096067	12011359	
47394	85,00	105,00	13,00	BS	NBR	32425	gearbox	DB	011 997 4246	096067		81-35092-00
35147	85,00	105,00	13,00	BS blue	NBR	32425	differential	MAN	06 56289 0033	096067	12011359	81-35092-00
68541	85,00	105,00	13,00	BS	NBR	32425	gearbox	MAN	06 56289 0167	096067	12011359	
70525	85,00	105,00	13,00	BS	NBR	32425	differential	SCANIA	386 901	096067		
48261	91,00		8,00		graph.		crankshaft	DB	000 997 9641	101577		
47001	20,00	30,00	7,00	A	NBR	17504	transfer gearbox	DB	004 997 7146	102300		
3899	40,00	58,00	10/17	AS2 LD W	NBR	114012	differential	PEUGEOT	3121 09	102946		
80358	80,00	100,00	10,00	AW/BS WD	FPM	47995	differential	MAN	06 56289 0349	104290	01020467	
114749	75,00	95,00	10,00	A/B WD	FPM	47938	differential	MAN	06 56279 0331	104310	01016962	
113149	75,00	95,00	9,5/10	A/BS	NBR	114110	differential	DB	017 997 3047	104320	01020042	

dph-no	dim 1	dim 2	dim 3	Style	Material	dph oil seal no.	Application	Type	OEM-NO	Eling	Corteco	Reinz
69845	75,00	95,00	9,5/10	A/BS	NBR	114110	differential	MAN	06 56279 0335	104320	01020042	
93378	80,00	100,00	10,00	BS	NBR	42528	rear axle	DB	017 997 7947	104330	01020468	
61486	80,00	100,00	10,00	BS	NBR	42528	crankshaft	MAN	06 56289 0353	104330	01020468	
95981	160,00	180,00	10,00	A/B WD	NBR	94702	front axle	DB	015 997 5847	104470	01019888	
113667	160,00	180,00	10,00	A/B WD	NBR	94702	front axle	MAN	06 56289 0365	104470	01019888	
83892	160,00	180,00	10,00	A/BS	NBR	94701	front axle	MAN	06 56289 0366	104480	01019887	
46852	75,00	100,00	13,00	CS	NBR	97437	wheel hub	DB	000 997 1446	105414	12011411	
93449	110,00	140,00	13,00	CS	NBR	18871	wheel hub	MAN	06 56289 0236	105422	01003701	
96198	120,00	140,00	13,00	BS	NBR	94932	gearbox	DEUTZ	247 5845	105457		
94513	120,00	140,00	13,00	BS	NBR	94932	crankshaft	IVECO	247 5845	105457	12012064	
47602	20,00	35,00	7,00	A	NBR	17512	crankshaft	DB	006 997 7447	106208	12010825	
33650	20,00	35,00	7,00	A	NBR	17512	gearbox	MAN	81 96502 0326	106208	12010825	
96645	36,00	54,00	7,00	AS WD	ACM	96644	differential	RENAULT	77 03 087 087	107794	12015283	
47543	80,00	100,00	10,00	AS	NBR	18682		DB	004 997 2047	108499		
81414	125,00	150,00	13,00	BS	NBR	18911	wheel hub	VOLVO	946 093-2	108626	12011367	
34017	50,00	70,00	8,00	C blue	NBR	61496	front axle	DB	006 997 9046	108642		
34018	50,00	70,00	8,00	C blue	NBR	61496	front axle	DB	008 997 9746	108642	01020675	
80537	50,00	70,00	8,00	C	NBR	61496	front axle	MAN	06 56279 0029	108642	01020675	
109167	150,00	180,00	13,00	A	NBR	6713	front-/rear axle	DEUTZ	116 7518	109657		
110738	150,00	180,00	13	A	NBR	6713	front-/rear axle	IVECO	852 7970	109657	12011091	
46872	48,00	80,00	12/18	BS2	NBR	47964		DB	003 997 0746	109916		
47351	48,00	80,00	12/18	BS2	HNBR	48053		DB	010 997 2246	109916		
46858	22,00	35,00	7,00	A	NBR	17557	crankshaft	DB	000 997 2546	120103	12010836	81-15377-00
97379	42,00	55,00	7,00	AS W RD	FPM/ACM	97538	FPM/ACM crankshaft	OPEL	638 199	127610	20020389	81-33489-00
109114	80,00	100,00	13,00	A/BS W LD	MVQ	37509	crankshaft back	BMW	11 14 1 255 015	128210	19030094	81-18304-00
82480	80,00	100,00	13,00	A/BS W LD	MVQ	37509	crankshaft	RENAULT	77 03 087 080	128210	19930094	
114557	29,85	47,00	11,30	combi	ACM	95498		CITROEN	3121.26	128240	20015497	
98169	29,85	47,00	11,30	combi	ACM	95498	differential	PEUGEOT	3121 26	128240	20015497	
115081	40,00	58,00	11,30	AS SP WD	ACM	96528	differential	PEUGEOT	3121 27	128250	07015496	
98140	32,00	47,00	10,00	AS RD SP	PTFE/ACM	112807	crankshaft	VW	038 103 085 C	129780	20026413	
111383	23,00	36,00	6/7	A W RD	NBR	111391		CITROEN	2109.40	131860	07015547	
111817	23,00	36,00	6/7	A W RD	NBR	111391	gearbox	PEUGEOT	2109 40	131860	07015547	
47385	25,00	32,00	5,00	B OF	NBR	48055	gearbox	DB	011 997 2246	134600	01002919	
117332	25,00	32,00	5,00	B OF	NBR	48055	gearbox	MAN	81 96502 0117	134600	01002919	
84462	85,00	105,00	8,00	ASW LD	FPM/ACM	112606	crankshaft	PEUGEOT	0514 74	135110	20018066	81-23708-50

dph-no	dim 1	dim 2	dim 3	Style	Material	dph oil seal no.	Application	Type	OEM-NO	Eling	Corteco	Reinz
115420	38,00	50,00	6,20	AS RD	FPM	115436	crankshaft	BMW	11 14 7 790 962	135140	19033909	
109077	38,00	50,00	6,00	AS RD	FPM	109076	camshaft	PEUGEOT	0807 24	135140	20018317	81-34146-00
113644	30,00	47,00	7,00	A WD	FPM	113644	camshaft	VOLVO	3 514 943	135150	01500581	
108806	44,45	57,15	6,75	AS RD	FPM	108806	crankshaft	VOLVO PC	6 842 272	135180	15018287	81-33634-00
115406	97,00	110,00	8,00	A LD felt	FPM	113718	crankshaft	VOLVO PC	6 842 274	135190		
95574	97,00	110,00	8,00	A LD felt	FPM	113718	crankshaft	VOLVO PC	9 458 178	135190	15510087	
46948	25,00	37,00	7,00	A	NBR	17609	crankshaft	DB	002 997 6346	137006		
21628	25,00	37,00	7,00	A	NBR	17609	crankshaft	DB	004 997 1646	137006	12010848	
81121	95,00	115,00	13/12	A/B LD	FPM	93240	gearbox shaft	DB	013 997 7347	141950	01017136	
97431	52,00	68,00	8,00	A/BS RD	FPM	96995	gearbox	DB	015 997 0647	141960	12018806	
97423	52,00	68,00	8,00	A/BS RD	FPM	96995		DB	015 997 1647	141960	12018806	
117342	52,00	68,00	8,00	A/BS RD	FPM	96995	gearbox	MAN	81 96502 0403	141960	01029746	
82394	145,00	175/205,00	9/14	SP	NBR	80460	rear axle	DB	015 997 4947	147730	01027787	
82320	145,00	175/205,00	9/14	SP	NBR	80460	rear axle	MAN	06 56289 0371	147730	01027787	
82049	145,00	175/205,00	18/20	special	FPM	82044	rear axle	DB	020 997 0547	147731	01019245	81-91000-00
94339	53,00	71,00	11,50	BS WD	NBR	94338	rear axle	DB	017 997 3947	151920	01018030	
115847	120,00	140,00	12,00	AS W RD	PTFE/AEM	116003	crankshaft	SCANIA	1 392 708	152320		81-35997-00
109228	40,00	70/76,00	11/13,5	AW/BS RD SF	ACM	109304	differential	DB	025 997 0047	152940	01029803	
112729	35,00	48,00	10,00	AS W SP	AEM/PTFE	111624	crankshaft	VW	038 103 085 E	155560	20026412	81-34366-00
115529	42,00	54,00	6,00	AS RD	FPM/ACM	112276	crankshaft	OPEL	440 2706	157200	12018755	81-34413-00
112260	42,00	54,00	6,00	AS RD	FPM/ACM	112276	crankshaft	RENAULT	77 00 103 245	157200	12018755	81-34413-00
109070	32,00	42,00	8,00	AS RD W	FPM	113932	camshaft	VW	036 103 085 H	158060	20019960	
114625	100,00	130,00	12,00	AW/BS RD	PTFE/ACM	114411	crankshaft	MAN	51 01510 0273	158510	20031177	
116028	28,00	40,00	7,00	A	NBR	17697	crankshaft	DEUTZ	116 0652	164500		
33338	28,00	40,00	7,00	AS blue	NBR	93614	gearbox	OPEL	902 678	164500	12010874	
114556	28,00	40,00	7,00	AS	NBR	93614	crankshaft	RENAULT	094 83 504 09	164500	12010874	
48451	28,00	40,00	7,00	A	NBR	17697	crankshaft	VW	113 415 297	164500		
94506	24,00	52,00	10,00		FEFZ	94506	crankshaft	DB	315 030 0080	171557		70-20311-00
117251	154,00	180,00	12,00	A/BS LD	PTFE/AEM	115386	crankshaft	DAF	1370 127	175990	20029771	
93555	85,00	105,00	9,5/13	A/BS	NBR	93553	differential	DB	017 997 2847	198430	01029595	
93556	85,00	105,00	9,5/13	A/B WD	FPM	93554	differential	DB	017 997 2947	198440	01029594	
113956	110,00	130,00	12,00	AS W	FPM	113955		DB	024 997 8547	199450		
114558	30,00	40,00	7,00	A	NBR	113776	crankshaft	DAF	0119 199	201006	12010879	
114559	30,00	40,00	7,00	A	NBR	113776	crankshaft	MAN	06 56260 1911	201006	12010879	
116162	30,00	40,00	7/10	BABSL	NBR	6440		DB	003 997 0040	201200		

dph-no	dim 1	dim 2	dim 3	Style	Material	dph oil seal no.	Application	Type	OEM-NO	Eling	Corteco	Reinz
33254	30,00	42,00	7,00	A	NBR	17728	crankshaft	BMW	23 12 1 201 279	203408		
116038	30,00	42,00	7,00	A	NBR	17728	crankshaft	BMW	24 51 6 606 714	203408		
116120	30,00	42,00	7,00	A	NBR	17728	crankshaft	BMW	33 12 3 004 336	203408		
33269	30,00	42,00	7,00	A	NBR	17728	crankshaft	BMW	33 12 3 004 337	203408		
46916	30,00	42,00	7,00	A	NBR	17728	crankshaft	DB	001 997 9746	203408		
47603	30,00	42,00	7,00	A	NBR	17728	crankshaft	DB	006 997 7647	203408	12010880	
47633	30,00	42,00	7,00	A	NBR	17728	crankshaft	DB	007 997 8847	203408		
114560	30,00	42,00	7,00	A	NBR	17728	crankshaft	MAN	06 56260 1912	203408	12010880	
47649	30,00	47,00	8,00	AS	NBR	19169		DB	008 997 3547	206806		
47527	145,00	175,00	14,00	BS	NBR	4376	rear axle	DB	003 997 6647	208210	12011374	
47710	145,00	175,00	13,00	A/B W blue	NBR	82427	rear axle	DB	011 997 5247	208220		
47458	30,00	47,00	10,00	A	NBR	17745	crankshaft	DB	000 997 9747	208302		
94407	125,00	150,00	15/13	A/BS WD F	NBR	94406	rear axle	DB	015 997 5647	210294	12015501	
46949	110,30	133,30	12	C	NBR	46950	front axle	DB	002 997 6446	210382	01019319	
47516	110,30	133,30	12/10	C	NBR	68848	front axle	DB	003 997 2247	210382	01019319	
97152	30,00	52,00	7,00	A/B RD	ACM	111768	crankshaft	FIAT	4000 0470	212458	12011539	
111769	30,00	52,00	7,00	A/B RD	ACM	111768	crankshaft	FIAT	4000 4460	212458	12012411	
96714	44,00	60,00	10,00	combi	PTFE	114335	crankshaft	BMW	11 14 1 439 570	214680	20019548	81-28498-10
116115	45,00	65,00	10,00	AW BS RD	FPM	95149	rear axle	BMW	33 12 1 202 121	216046	20020503	
116116	45,00	65,00	10,00	AW BS RD	FPM	95149	rear axle	BMW	33 12 1 202 124	216046		
116117	45,00	65,00	10,00	AW BS RD	FPM	95149	rear axle	BMW	33 12 1 202 125	216046		
116118	45,00	65,00	10,00	AW BS RD	FPM	95149	rear axle	BMW	33 12 1 204 231	216046		
112419	45,00	65,00	10,00	AW BS RD	FPM	95149	rear axle	BMW	33 12 1 204 232	216046		
82533	115,00	133,00	13,00	AS W WD	NBR	82532	wheel hub	BPW	02 5664 18 57	216320	01033476	
47439	40,00	62,00	12/16	SP	ACM	116560	differential	DB	000 997 2647	219568		
46990	40,00	62,00	12/16	SP	ACM	116560	differential	DB	004 997 2546	219568		
46995	40,00	62,00	12/16	SP	ACM	116560	differential	DB	004 997 4146	219568		
46996	40,00	62,00	12/16	SP	ACM	116560	differential	DB	004 997 5646	219568		
47020	40,00	62,00	12/16	SP	ACM	116560	differential	DB	005 997 4146	219568		
47298	40,00	62,00	12/16	SP	ACM	116560	differential	DB	008 997 5146	219568		
47327	40,00	62,00	12/16	SP	ACM	116560	differential	DB	009 997 2346	219568		
109592	124,00	150,00	14,30	SP	NBR	109591		DB	021 997 6947	220450	01028965	
115480	85,00	155,00	12/33	SP	FPM	114403	differential	DB	021 997 8547	220660	01027938	
111752	56,00	72,00	8,00	A/BS RD	FPM	111751		DB	019 997 0547	220900	12019647	
112762	56,00	72,00	8,00	A/BS RD	FPM	111751	transfer gearbox	DB	019 997 0647	220900	12019647	

dph-no	dim 1	dim 2	dim 3	Style	Material	dph oil seal no.	Application	Type	OEM-NO	Eling	Corteco	Reinz
114758	78,00	135,00	12/21,5	SP	FPM/ACM	114392	differential	DB	018 997 7647	221710	01030117	
114580	40,00	52,00	7,00	AS W	ACM	114334	gearbox	DB	012 997 8247	221970	01026706	
112600	70,00	79,00	5,30	B OF SF	NBR	112599	stub axle	DB	020 997 4947	222000	01026376	
112282	75,00	100,00	10/13	KA	NBR	114389	wheel hub	SCANIA	1 409 890	222610	12017173	
112266	142,00	170,00	15/16	KA	NBR	112790	wheel hub	SCANIA	1 409 889	222620	12020496	
98061	84,93	104,77	18,26	SP1 RD	FPM/ACM	112634	crankshaft	SCANIA	1 386 594	222630	12018653	
112585	84,93	104,77	18,26	SP1 RD	FPM/ACM	112634	crankshaft	SCANIA	1 502 385	222630	12018653	
98060	84,93	104,77	12/18,26	SP2 LD	FPM/ACM	112636	front axle	SCANIA	1 393 331	222640	12018654	
111330	84,93	104,77	12/18,26	SP2 LD	FPM/ACM	112636	crankshaft	SCANIA	1 502 384	222640	12018654	
116234	140,00	164,00	20/23,50	SP	FPM	50173	rear axle	VOLVO	1 672 249	222757	12016932	
114611	95,00	115,00	15,50	A/BS LD	FPM	114408	gearbox	DB	023 997 1647	222830	01029684	
22998	51,00	58,00	4,00	BO	NBR	22996	stub axle	DB	006 997 7147	222940		
95663	42,00	55,00	7,00	A W RD	MVQ	96335	gearbox automatic	VW	003 519 089 D	225614		
47434	32,00	45,00	7,00	A	NBR	17829	wheel hub	DB	000 997 1147	227609	12000157	
47533	32,00	45,00	7,00	A	NBR	17829	wheel hub	DB	003 997 8647	227609		
46978	32,00	45,00	7,00	A	NBR	17829	wheel hub	DB	003 997 8946	227609		
50178	54,00	82,00	11,45	AS LD	ACM	4235	crankshaft	OPEL	614 814	231665	12010693	81-21343-00
4236	54,00	82,00	11,45	AS LD	ACM	4235	crankshaft	OPEL	614 818	231665	12010693	81-21343-00
59234	54,00	82,00	11,45	AS LD	ACM	4235	crankshaft	OPEL	614 831	231665		81-21343-00
109140	82,00	105,00	12,00	AS W LD	FPM	3914	crankshaft	ALFA	60517110	232300	12013892	
3915	82,00	105,00	12,00	AS W LD	FPM	3914	crankshaft	VW	056 103 051 A	232300	12013892	
46760	100,00	130,00	13,00	AW/BS	NBR	61447	front-/rear axle	DB	009 997 6747	232459	12000552	81-33861-00
96495	56,00	70,00	9/6	AS SP	NBR	80858	steering	DB	011 997 0346	235350		
47518	28,00	40,00	8/8,50	AS	NBR	48011	crankshaft	DB	003 997 2647	237744		
48358	28,00	40,00	8/6,00	AS SP	NBR	36704	steering	DB	011 997 7246	237744	12012574	
47021	50,80	65,00	9/9,50	AS	NBR	48040	steering	DB	005 997 4246	237752		
47404	50,80	65,00	9/9,50	AS	NBR	48040	steering	DB	011 997 7946	237752	01026321	
46864	54,80	70,00	9/9,60	AS	NBR	47963		DB	002 997 7746	237760		
47026	54,80	70,00	9/9,60	AS	NBR	47963		DB	005 997 5546	237760		
47405	54,80	70,00	9/7,00	AS SP	NBR	36703	steering	DB	011 997 8046	237760		
116033	40,00	55,00	8,00	AS W LD	ACM	50854	gearbox automatic	BMW	23 12 1 202 727	242993		
50855	40,00	55,00	8,00	AS W LD	ACM	50854	gearbox automatic	BMW	23 12 1 205 340	242993		81-35286-00
37344	21,90	40,00	8,00	AS RD	ACM	37343	gearbox	VW	020 311 113	244040		81-23807-00
51950	18,00	27,00	5/8	AS OF	NBR	51949	gearbox	VW	020 141 733	244082	01026910	
47353	70,00	90,00	10,00	B	NBR	18612	crankshaft	DB	010 997 2446	246891	12011533	

dph-no	dim 1	dim 2	dim 3	Style	Material	dph oil seal no.	Application	Type	OEM-NO	Eling	Corteco	Reinz
47368	70,00	90,00	10,00	B	NBR	18612	crankshaft	DB	010 997 6046	246891	12011533	
47701	70,00	90,00	10,00	B	NBR	18612	gearbox	DB	010 997 9647	246891	12011533	
47390	70,00	90,00	10,00	B	NBR	18612	crankshaft	DB	011 997 3346	246891		
70272	70,00	90,00	10,00	B	NBR	18612	injection pump	VOLVO	192 600-5	246891		
94046	26,30	36,20	7,30	AS	NBR	94045		VOLVO	943 741-9	246905	01027966	
81585	100,00	124,00	10,5/12,5	AS W LD	MVQ	81587	crankshaft	DB	001 997 8747 FE	247189		81-22887-00
96052	42,00	58/60,00	19,5/7	B SP RD	MVQ	96050	gearbox	VW	010 409 568 A	249173		
47576	35,00	47,00	7,00	A	NBR	17906	crankshaft	DB	005 997 5847	251402	12010904	
46898	68,00	90,00	10,00	A	NBR	4546	crankshaft	DB	001 997 1846	251720	12011012	
47361	68,00	90,00	10,00	A	NBR	18598	crankshaft	DB	010 997 5046	251720		
113942	68,00	90,00	10,00	A	NBR	4546	crankshaft	RVI	0024 411 680	251720	12011012	
47493	140,00	160,00	13,00	BS	NBR	70576	rear axle	DB	002 997 3247	255637	12011349	
84394	140,00	160,00	13,00	BS	NBR	70576	rear axle	MAN	06 56289 0186	255637	12011349	
115397	65,00	79,00	20,00	AS RD	PTFE/AEM	115400	crankshaft	BMW	11 11 7 511 395	257400	20033890	81-34057-00
47575	35,00	52,00	10,00	A	NBR	17934	crankshaft	DB	005 997 5147	258407		
47664	35,00	52,00	10,00	A	NBR	17934	crankshaft	DB	009 997 5147	258407	12010908	
70484	35,00	52,00	10,00	A	NBR	17934	gearbox	SCANIA	32 201	258407	12010899	
109809	81,00	100/137,00	10/15,5	SP	FPM	109813	ABS with pulse wheel	MAN	81 52403 6001	265960	01026330	
98109	37,00	61,00	10/14	AW/B RD SP	ACM	47999	differential	DB	023 997 9047	268420	01019477	
116197	35,00	62,00	7,00	AS W WD	ACM	84536	injection	SCANIA	228 109	269700		
82102	30,00	42,00	7,00	AS RD	ACM	82102	gearbox	BMW	23 11 1 228 314	277142		
116032	30,00	42,00	7,00	AS RD	FPM	51727	manual transmission	BMW	23 12 1 202 715	277142		
84217	30,00	42,00	7,00	AS RD	FPM	51727	manual transmission	BMW	23 12 1 205 186	277142	12010674	
109073	30,00	42,00	7,00	AS RD	FPM	51727	camshaft	FIAT	4000 4240	277142	12010674	
116031	40,00	55,00	7,00	A	NBR	18074	crankshaft	BMW	23 11 1 230 087	277150		
33256	40,00	55,00	7,00	A	NBR	18074	crankshaft	BMW	23 12 1 230 087	277150		
116042	48,00	62,00	7,00	BS	NBR	19660	rear axle	BMW	31 21 1 118 478	277223		
116043	48,00	62,00	7,00	BS	NBR	19660	rear axle	BMW	31 21 1 119 139	277223		
80575	48,00	62,00	7,00	BS	NBR	19660	rear axle	BMW	31 21 1 119 200	277223		
116112	48,00	62,00	7,00	BS	NBR	19660	rear axle	BMW	31 21 1 125 912	277223		
33268	20,00	42,00	7,00	AS WD blue	NBR	48013	steering	BMW	32 41 1 117 621	277290		
47532	20,00	42,00	7,00	AS WD	NBR	48013	steering	DB	003 997 8147	277290	12012842	
97172	35,00	60,00	15,00	AS	NBR	97174	crankshaft	VW	113 301 189 F	277517		
37511	45,00	72,00	15,00	AS2W WD	NBR	37510	differential	VW	091 301 189 A	277525		
37381	19,05	33,33	7,93	AS	NBR	95982	steering	DB	004 997 1247	278556		

dph-no	dim 1	dim 2	dim 3	Style	Material	dph oil seal no.	Application	Type	OEM-NO	Elring	Corteco	Reinz
3910	19,05	33,33	7,93	AS blue	NBR	95982	steering	DB	006 997 0247	278556	01020304	
47608	19,05	33,33	7,93	AS	NBR	95982	steering	DB	006 997 9247	278556		
111516	15,00	24,00	7,00	AS	NBR	97768	gearbox	VW	085 301 227	279528		
70461	130,00	160,00	13,00	B	NBR	45614	rear axle	SCANIA	178 866	281972		
47659	105,00	130,00	12,00	AS	NBR	97860		DB	009 997 0647	282200	12013364	
80059	105,00	130,00	12,00	AS	NBR	97860	gearbox	MAN	81 96502 0349	282200	12011062	
47643	46,00	64,00	8,00	B RD	FPM	47998	gearbox	DB	008 997 1947	283827		
47355	46,00	64,00	8,00	B RD	FPM	47998	gearbox	DB	010 997 2946	283827	12015259	
47367	46,00	64,00	8,00	B RD	FPM	47998	gearbox	DB	010 997 5946	283827		
47700	46,00	64,00	8,00	B RD	FPM	47998	gearbox	DB	010 997 9447	283827	12015259	
47454	65,00	90,00	15,00	B RD	FPM	47957	crankshaft	DB	000 997 7947	283983		
47002	65,00	90,00	13,00	AW/BS RD vlies	FPM	84257	crankshaft	DB	004 997 7346	283983		
35019	65,00	90,00	15,00	B RD	FPM	47957	crankshaft	DB	006 997 5446	283983	12014380	
47604	65,00	90,00	15,00	B RD	FPM	47957	crankshaft	DB	006 997 8547	283983		
47292	65,00	90,00	15,00	B RD	FPM	47957	crankshaft	DB	008 997 1446	283983		
48067	65,00	90,00	15,00	B RD	FPM	47957	crankshaft	DB	009 997 6146	283983		
47340	65,00	90,00	15,00	B RD	FPM	47957	crankshaft	DB	009 997 6246	283983		
47679	65,00	90,00	13,00	AW/BS RD F	FPM	84257	crankshaft	DB	010 997 5247	283983		81-20504-10
4144	55,00	68,00	8,50	AS W	NBR	36319	front axle	VW	251 407 641 A	284459	12013929	
48162	55,00	68,00	8,50	AS W	NBR	36319	front axle	VW	281 407 641 C	284459	12013929	
36793	55,00	75,00	8,00	B RD	FPM	36792	gearbox	DB	007 997 2247	284645	12011308	
47305	55,00	75,00	8,00	B RD	FPM	36792	gearbox	DB	008 997 7246	284645		
93804	55,00	75,00	8,00	B RD	FPM	36792	gearbox	MAN	81 96502 0761	284645	12011308	
15264	45,00	74,50	12/14,50	AS W RD	ACM	15238	crankshaft	DB	004 997 6846	284742		
47636	45,00	67/72,00	12/13	AS W RD	FPM	47996	crankshaft	DB	008 997 0447	284785	12012247	
37326	45,00	67/72,00	12/13	AS W RD	FPM	47996	crankshaft	DB	008 997 0547	284785	12012247	
47461	45,00	67,00	12/13,00	BS RD LA	FPM	36211		DB	001 997 0947	287202		
47462	45,00	67,00	12/13,00	BS RD LA	FPM	36211		DB	001 997 1047	287202		
47552	45,00	67,00	12/13	A/BS RD W	ACM	50166	crankshaft	DB	004 997 6647	287202		
47652	45,00	67,00	12/13	A/BS RD W	ACM	50166	crankshaft	DB	008 997 4047	287202		
47304	45,00	67,00	12/13	A/BS RD W	ACM	50166	crankshaft	DB	008 997 7046	287202		
80244	105,00	130,00	12,00	AW/BS RD vlies	FPM	112532	crankshaft	MAN	51 01510 0138	288039		
81568	130,00	160,00	16,00	A/BS WD	FPM	81341	crankshaft	MAN	06 56289 0385	290180	01017013	
82535	125,00	142,00	13,00	AS W WD	NBR	82534	crankshaft	BPW	02 5664 28 57	292650	01019878	
113541	160,00	188,00	14,00	AS W WD SP	NBR	113540	steering	BPW	02 5664 64 57	292660		

dph-no	dim 1	dim 2	dim 3	Style	Material	dph oil seal no.	Application	Type	OEM-NO	Elring	Corteco	Reinz
93637	48,00	64,00	12/6	BS WD	NBR	93636	wheel hub	DB	019 997 8847	293400	01019283	
59258	35,00	50,00	7,00	A W RD	MVQ	59255	crankshaft	CITROEN	7910 006 487	293946		
115733	35,00	50,00	8,00	A RD	ACM	3900	camshaft	Mitsubishi	MD 008762	293946	19015083	
3901	35,00	50,00	8,00	A RD	ACM	3900	crankshaft	PEUGEOT	0514 15	293946	12011547	81-21798-30
109272	35,00	48,00	10,00	A/BS W RD	FPM	81442	crankshaft	FORD	1 005 301	294357		81-24292-10
51384	35,00	48,00	10,00	A/BS W RD	FPM	81442	crankshaft	VOLVO PC	1 257 113	294357	12010739	81-24292-10
81442	35,00	48,00	10,00	A/BS W RD	FPM	81442	crankshaft	VW	069 115 147 C	294357	12010739	81-24292-10
47377	145,00	175,00	13,00	A/B W blue	NBR	82427	rear axle	DB	011 997 0146	294500	12014407	81-91001-00
118512	90,00	110,00	10,00	AS W LD	FPM/ACM	118512	crankshaft	PEUGEOT	0119 06	294683	12010750	
113943	85,00	110,00	13,00	AS	NBR	18731	wheel hub	RVI	5000 788 400	300896		
108798	85,00	110,00	13/9,5	A	NBR	81336	wheel accessory kit	VOLVO	947 270-5	300896	12013388	
115456	35,00	50,00	8,00	AS WD W	FPM	112621	crankshaft	PEUGEOT	0236 14	302589	12016927	81-21798-50
47591	45,00	67,00	12/13,00	BS RD LA	FPM	36211	crankshaft	DB	006 997 1247	305529	12011247	81-21023-30
47654	45,00	67,00	12/13,00	BS RD LA	FPM	36211	crankshaft	DB	008 997 5247	305529	12012247	81-21023-30
47460	45,00	74,5/79,5	12/13	A SP RD	FPM/ACM	47997	crankshaft	DB	001 997 0847	309028		
47486	45,00	74,5/79,50	12/13	A SP RD	FPM/ACM	47997	crankshaft	DB	002 997 0847	309028	12010743	
47019	45,00	74,5/79,5	12/13	A SP RD	FPM/ACM	47997	crankshaft	DB	005 997 3846	309028		81-17328-20
47242	45,00	74,5/79,5	12/13	A SP RD	FPM/ACM	47997	crankshaft	DB	006 997 8046	309028		
47640	45,00	74,5/79,5	12/13	A SP RD	FPM/ACM	47997	crankshaft	DB	008 997 1547	309028	12010743	
47641	45,00	74,50	12/14,50	A SP RD	FPM/ACM	47997	crankshaft	DB	008 997 1647	309028	12010743	
47296	45,00	74,50	12/14,50	A SP RD	FPM/ACM	47997	crankshaft	DB	008 997 2346	309028		
36153	45,00	74,5/79,5	12/13	A SP RD	FPM/ACM	47997	crankshaft	DB	009 997 4547	309028	12010743	
47588	45,00	74,5/79,5	12/13	A SP RD	FPM/ACM	47997	crankshaft	DB	005 997 9047	312010	12010743	
48037	45,00	74,5/79,5	12/13	A SP RD	FPM/ACM	47997	crankshaft	DB	009 997 8547	312010	12010743	
47491	40,00	70,00	12/16	SP RD	ACM	48005	rear axle	DB	002 997 2147	312444		
47513	40,00	70,00	12/16	SP RD	ACM	48005	rear axle	DB	003 997 1147	312444		81-35073-00
47014	40,00	70,00	12/16	SP RD	ACM	48005	rear axle	DB	005 997 1246	312444		81-35073-00
47372	40,00	70,00	12/16	SP RD	ACM	48005	rear axle	DB	010 997 7846	312444		81-35073-00
47378	40,00	70,00	12/16	SP RD	ACM	48005	rear axle	DB	011 997 0446	312444	12015258	81-35073-00
81898	40,00	70,00	12/16	SP RD	ACM	48005	rear axle	DB	014 997 4947	312444	12015258	
3907	40,00	49,60	5,5/7,30	AO LD	MVQ	3906	crankshaft	PEUGEOT	2074 07	314501	46083012	81-21649-00
47660	105,00	130,00	12/9,5	AW/BS LD	ACM	95476		DB	009 997 0747	314994	01018282	
61236	105,00	130,00	12,00	A/BS LD	FPM	48035	crankshaft	MAN	81 96502 0350	314994	01018282	
59263	85,00	105,00	12,00	AS W LD	FPM/ACM	114899	crankshaft	PEUGEOT	0514 40	315494	12012347	
111184	85,00	105,00	12,00	AS W LD	FPM/ACM	114899	crankshaft	VW	049 103 051 D	315494		

dph-no	dim 1	dim 2	dim 3	Style	Material	dph oil seal no.	Application	Type	OEM-NO	Eling	Corteco	Reinz
46971	125,00	160,00	18,00	BS LD F	FPM	36207	crankshaft	DB	003 997 6746	316385		
36216	125,00	160,00	18,00	BS LD F	FPM	36207	crankshaft	DB	004 997 9347	316385	12012432	81-21040-10
47335	125,00	160,00	18,00	BS LD F	FPM	36207	crankshaft	DB	009 997 5146	316385	12012432	
47530	44,00	60,00	8,00	B RD LA	MVQ	15241	gearbox	DB	003 997 7247	319104		
47531	44,00	60,00	8,00	B RD LA	MVQ	15241	gearbox	DB	003 997 7347	319104		
15265	44,00	60,00	8,00	B RD LA green	MVQ	15241	gearbox	DB	004 997 0547	319104		
47249	44,00	60,00	8,00	B RD LA	MVQ	15241	gearbox	DB	007 997 0246	319104		
47393	44,00	60,00	8,00	B RD LA	MVQ	15241	gearbox	DB	011 997 3946	319104		
47410	40,00	52,00	7,00	A	NBR	18068	wheel hub	DB	011 997 8846	321508		
47418	40,00	52,00	7,00	A	NBR	18068	wheel hub	DB	350 997 7746	321508		
3897	40,00	52,00	7,00	A	NBR	18068	wheel hub	PEUGEOT	3724 12	321508	12019046	
109688	110,00	130,00	13,00	A/BS LD	FPM/PTFE	109691	crankshaft	MAN	51 01510 0151	323772	12015384	81-33801-00
111394	60,40	80,00	12,00	BS RD SP	FPM	109799	crankshaft	MAN	51 01510 0152	323780	12015383	81-24895-00
97153	40,00	56,00	7,00	B RD	ACM	48470	crankshaft	FIAT	4000 0050	325007	12011455	
112546	40,00	56,00	7,00	B RD	ACM	48470	crankshaft	IVECO	4000 0050	325007	12011455	
6512	32,00	47,00	10,00	W WD	FPM/ACM	97600	crankshaft	VW	026 103 085	325155	12012709	
34694	32,00	47,00	10,00	AS W WD	FPM/ACM	97600	crankshaft	VW	056 103 085	325155	12012709	
35013	32,00	47,00	10,00	AS W WD	FPM	37434	crankshaft	VW	068 103 085	325155	12012709	81-19299-10
117399	70,00	100,00	12,00	A	NBR	84533	crankshaft	IVECO	3851 4100	325473	12011017	
110727	70,00	100,00	12,00	A	NBR	84533	engine various	IVECO	851 101	325473	12011017	
70486	70,00	100,00	12,00	A	NBR	84533	crankshaft	SCANIA	33 326	325473	12011017	
34422	150,81	177,80	12,70	AS blue	NBR	84589	wheel hub	SCANIA	159 496	325503	12011092	
34423	117,47	142,87	12,70	A blue	NBR	84532	crankshaft	SCANIA	173 320	325511	12011073	
70483	45,00	65,00	9,00	BS RD LA	ACM	81126	gearbox	SCANIA	314 063	325562	12011970	
35053	75,00	95,00	10,00	AW LD	FPM/ACM	95002	crankshaft	VW	029 105 245 B	326798	20019852	
4615	170,00	190,00	8,50	AS K	NBR	4045	rear axle	DB	005 997 8447	327247	12012576	
4046	170,00	190,00	8,50	AS K	NBR	4045	rear axle	DB	009 997 8846	327255	12012577	
47563	75,00	95,00	10/9,50	B WD	FPM	4380	transfer gearbox	DB	005 997 0947	327263	01019459	
47565	75,00	95,00	10/9,50	B WD	FPM	4380	transfer gearbox	DB	005 997 1147	327263		
47568	75,00	95,00	10/9,50	B WD	FPM	4380	transfer gearbox	DB	005 997 1947	327263		
47323	75,00	95,00	10/9,50	B WD	FPM	4380	transfer gearbox	DB	009 997 1446	327263		
116034	15,00	21,00	5,00	BS	NBR	37114	gearbox	BMW	23 12 1 222 677	327298		
98438	15,00	21,00	5,00	BS	NBR	37114	gearbox	BMW	23 12 1 282 394	327298		
108800	15,00	21,00	5,00	BS	NBR	37114	gearbox	VOLVO	947 705	327298	01019151	81-24010-00
81190	75,00	95,00	10/9,50	B WD	FPM	4380	transfer gearbox	MAN	06 56279 0215	327363	01019459	

dph-no	dim 1	dim 2	dim 3	Style	Material	dph oil seal no.	Application	Type	OEM-NO	Eling	Corteco	Reinz
37866	31,00	50,00	8,00	AS RD	FPM	37865	crankshaft	OPEL	646 263	330736	12013458	
47013	40,00	62,00	10,00	A	NBR	18107	automatic gearbox	DB	005 997 1146	330809	12010936	
36988	40,00	62,00	10,00	A	NBR	18107	automatic gearbox	DB	008 997 9246	330809	12010936	81-21001-20
114583	40,00	62,00	10,00	A	NBR	18107	automatic gearbox	OPEL	744 500	330809	12010936	
109703	88,00	108,00	11,10	AW/BS LD	FPM	80639	crankshaft	SAAB	91 75 902	330959		81-25452-10
37650	48,00	66,65	10,00	AS RD W	MVQ	37651	crankshaft	SAAB	93 09 204	330965		81-25789-00
47500	70,00	81,50	6,00	AW V	NBR	48009	front axle	DB	002 997 6547	331163	20016779	
47508	70,00	81,50	6,00	AW V	NBR	48009	front axle	DB	002 997 8847	331163	20016779	
46894	68,00	90,00	13,00	BS RD	FPM	47947	differential	DB	000 997 3846	331171		
46893	68,00	90,00	13,00	BS RD	FPM	47947	differential	DB	000 997 8946	331171		81-35083-00
47487	68,00	90,00	13,00	BS RD	FPM	47947		DB	002 997 1047	331171		81-35083-00
46964	68,00	90,00	13,00	BS RD	FPM	47947		DB	003 997 4446	331171	12012074	81-35083-00
47637	68,00	90,00	13,00	BS RD	FPM	47947	differential	DB	008 997 0747	331171	12012074	81-35083-00
47638	68,00	90,00	13,00	BS RD	FPM	47947	differential	DB	008 997 0847	331171	12012074	81-35083-00
47366	68,00	90,00	13,00	BS RD	FPM	47947	differential	DB	010 997 5746	331171		81-35083-00
47412	68,00	90,00	13,00	BS RD	FPM	47947	differential	DB	011 997 9846	331171	12012074	81-35083-00
94728	90,00	110,00	15,00	BS RD LA	FPM	94728	crankshaft	DEUTZ	241 6507	331198		81-22593-20
114569	35,00	47,00	7,00	AS RD	MVQ	37506	crankshaft	VOLVO PC	1 306 333	336998		81-25582-00
115506	35,00	47,00	6,00	AS RD	FPM	113719	crankshaft front	VOLVO PC	6 842 273	336999	12015674	
4277	85,00	105,00	12,00	A/BS LD W	FPM	61492	crankshaft	VOLVO PC	1 257 049	342092	12012347	
61492	85,00	105,00	12,00	A/BS LD W	FPM	61492	crankshaft	VOLVO PC	3 287 542	342092	12012347	81-36788-00
47644	93,00	117,00	12,00	BS LD LA	FPM	6648	crankshaft	DB	008 997 2547	344230		
15262	93,00	117,00	12,00	BS LD LA	FPM	6648	crankshaft	DB	008 997 2647	344230	12012246	81-25242-00
47663	93,00	117,00	12,00	BS LD LA	FPM	6648	crankshaft	DB	009 997 3647	344230		
36224	93,00	117,00	12,00	BS LD LA	FPM	6648	crankshaft	DB	010 997 8247	344230	12012246	81-25242-00
94685	42,00	56,00	7,00	AS	NBR	94735	water pump	DAF	0213 966	344400		
46969	42,00	56,00	7,00	AS W	NBR	94735	water pump	DB	003 997 5146	344400	12010943	81-51109-00
47560	42,00	56,00	7,00	AS	NBR	94735	water pump	DB	005 997 0047	344400	12010943	
46966	165,00	190,00	13,00	BS	NBR	47254	rear axle	DB	003 997 4846	346640		
47272	165,00	190,00	13,00	BS	NBR	47254	rear axle	DB	007 997 8246	346640	01002772	
111395	30,00	50,00	10,00	A W RD	FPM	111402	crankshaft	PORSCHE	999 113 29041	347922		
95055	180,00	200,00	12,00	BS	NBR	82893	crankshaft	IVECO	4000 3720	348376	12011378	
98440	180,00	200,00	12,00	BS	NBR	82893	crankshaft	IVECO	4203 7581	348376	12011378	
114735	70,00	90,00	10,00	AS W LD	FPM	47944		DAF	0140 784	348856	12014736	
46908	70,00	90,00	10,00	AS W LD	FPM	47944	crankshaft	DB	001 997 8146	348856		

dph-no	dim 1	dim 2	dim 3	Style	Material	dph oil seal no.	Application	Type	OEM-NO	Eling	Corteco	Reinz
46918	70,00	90,00	10,00	AS W LD	FPM	47944	gearbox	DB	002 997 1046	348856		
46959	70,00	90,00	10,00	AS W LD	FPM	47944		DB	003 997 3346	348856		
47626	70,00	90,00	10,00	AS W LD	FPM	47944	gearbox	DB	007 997 6047	348856	12015772	
94055	62,00	80,00	12/11	AS W LD	MVQ	82138	crankshaft	DEUTZ	223 4498	352136	01034681	
114741	70,00	95,00	13/14,5	KA SP	NBR	110618		DB	022 997 1247	354080		
111272	130,00	160,00	13,00	SP	PTFE	111404	crankshaft	SCANIA	369 478	354390	20017235	81-25014-20
114652	135,00	175,00	15,5/20	KA	NBR	114420	crankshaft	MAN	06 56289 0268	357170	01019880	
115410	30,00	42,00	7,00	AS RD	FPM	51727	manual transmission	RENAULT	77 00 101 348	365940	20019850	
115614	48,00	68,00	9,30	A/BS	NBR	117963	magnetic oil seal	DB	203 330 0060	366230	01032572	
47755	45,00	62,00	10,00	A	NBR	18223	crankshaft	DB	304 997 1347	367206	12010954	
114595	45,00	62,00	10,00	A	NBR	18223	crankshaft	MAN	06 56279 0039	367206	12010954	
114624	100,00	130,00	12,00	AW/BS RD	PTFE/ACM	114411	crankshaft	DB	021 997 5247	369900	20029784	
117452	100,00	130,00	11,00	AW/BS RD	PTFE/ACM	117451	crankshaft	DB	025 997 3947	369901	20034028	
109684	100,00	130,00	12,00	A/B	FPM	109686	wheel hub	MAN	06 56289 0369	374360	01020679	
114783	80,00	135/154,00	13,5/18	BS RD SP	FPM	114398	crankshaft	MAN	06 56289 0293	379300	01020677	
111285	80,00	100,00	13,00	AS SP	PTFE	111403	crankshaft	SCANIA	369 477	382100	20017234	81-25013-30
114491	120,00	150,00	15/20,2	A/BS	NBR	114428	wheel hub	DB	013 997 7346	383260	01033873	
84468	33,00	56,00	11,8/9	A/B WD	ACM	84729	differential	DB	014 997 5747	388180	01019286	
93581	48,00	65,00	10,00	A	NBR	18283	crankshaft	PORSCHE	999 113 01250	388904		81-17404-00
114594	45,00	62,00	8,00	AW/BS RD	ACM	114336	crankshaft	VOLVO	1 546 480	390010	01030097	
94989	30,00	54,00	15/19,30	AS LD SP	FPM	113724	camshaft	VOLVO PC	3 507 309	393880	15029743	81-35989-00
4067	48,00	72,00	7/9	AS2	NBR	50513	wheel hub	VW	211 501 317	394009	12013894	
3908	50,00	64,00	10/13,00	B	NBR	37519	rear axle	DB	001 997 4746	411701	12011385	
48452	50,00	65,00	8,00	A	NBR	97943	wheel hub	VW	211 405 641 D	412104	12010966	
47437	50,00	72,00	10,00	A	NBR	18335	crankshaft	DB	000 997 2247	418501	12010971	
47034	50,00	72,00	10,00	A	NBR	18335	crankshaft	DB	005 997 8546	418501	12010971	
114602	45,00	67,00	8,00	ASW RD	PTFE	114339	crankshaft	DB	021 997 1847	424841	20026532	
115782	45,00	67,00	8,00	AS W RD	PTFE	114339	crankshaft	DB	021 997 7647	424841		81-26248-10
114603	45,00	67,00	8,00	ASW RD	PTFE	114339	crankshaft	DB	023 997 8447	424841	20026532	
95354	90,00	145,00	10/15	A/B SP	FPM	94049	differential	VOLVO	1 523 239	435180	12015693	81-35132-00
115687	90,00	145,00	10/15	A/B SP	FPM	94049	differential	VOLVO	1 673 701	435180	01034125	
112427	90,00	145,00	10,00	A/BS LD	FPM	112716	automatic gearbox	VOLVO	1 652 776	435340	12016675	81-35136-00
114720	64,90	90,00	9,5/10	A/B RD felt	FPM	112981	gearbox	VOLVO	1 521 431	435820	01030098	
47428	55,00	70,00	8,00	A	NBR	18407	wheel hub	DB	608 997 1346	440302	12010981	
111783	23,00	35,00	7,00	A/BS RD	FPM	111782	crankshaft	FIAT	4000 4200	440710	12011305	81-35719-00

dph-no	dim 1	dim 2	dim 3	Style	Material	dph oil seal no.	Application	Type	OEM-NO	Eling	Corteco	Reinz
111787	30,00	43,00	8,00	A/BS RD	FPM	111786	camshaft	ALFA	6080 5219	440730	12001538	
97150	42,00	56/63,00	7,20	B RD	ACM	112611	crankshaft	FIAT	4000 0320	440770	12011279	
111774	74,00	90,00	10,00	A/BS LD	FPM	111773	crankshaft	FIAT	6080 5182	440830	12001540	
113041	78,00	104,00	11,00	AW/BS RD	PTFE	114391	crankshaft	DB	022 997 7647	445591	20025510	81-36198-00
113042	115,00	140,00	13,00	AW/BS LD	PTFE/ACM	114417	crankshaft	DB	021 997 5347	445600	20029785	81-36197-00
96854	55,00	80,00	10,00	BS	NBR	50343	gearbox	DB	004 997 6646	446602		
117329	55,00	80,00	10,00	BS	NBR	50343	gearbox	MAN	06 56279 0136	446602		
35209	55,00	80,00	10,00	A	NBR	18431	transmission	MAN	81 96501 0445	446602		
95475	85,00	145,00	12/37	SP SP	FPM	95864	differential	DB	015 997 4747	447080	01017059	
114776	85,00	145,00	12/37	SP	FPM	95864	differential	MAN	06 56289 0319	447080	01017059	
97220	125,00	150,00	14,00	SP	FPM	113954	wheel hub	DB	022 997 5247	451100	01027682	
114490	145,00	175,00	15,00	A W	ACM	114456	wheel hub	DB	013 997 3546	451110	01033415	
114722	65,00	85,00	15,50	A/BS WD	FPM	114369	transfer gearbox	DB	011 997 4447	451120	01029680	
114715	62,00	80/86	9/14	KA	NBR	114365	wheel hub	DB	905 997 0246	453910	01029698	
119409	90,00	110,00	11,00	AS W RD	PTFE/ACM	119416	crankshaft	RENAULT	50 10 359 806	453930	15026914	81-37914-00
82965	95,00	130,00	16,00	KA SP	FPM/ACM	93221	crankshaft	IVECO	4010 2143	454000	12015509	
114856	179,00	200,00	15,5/16,5	KA	FPM	114855	wheel hub	IVECO	4010 2940	456130	12017354	
118924	179,00	200,00	15,5/16,5	KA	FPM	114855	wheel hub	IVECO	4010 2943	456130	12017354	
114698	55,00	80,00	8,00	A/BS RD	FPM	114359	gearbox	DB	021 997 1747	456970	01030099	
114699	55,00	80,00	8,00	A/BS RD	FPM	114359	gearbox	DB	021 997 2547	456970	01030099	
114875	75,00	100,00	11,00	AW/BS blue	NBR	114874	wheel hub	DB	019 997 5847	457120	12018888	
119559	40,00	55,00	7,00	AW/BS RD	FPM	118615	camshaft	Fiat	4643 4591	457220	12016528	
119407	150,00	172,00	13,00	AW LD W	PTFE/ACM	119414	crankshaft	RENAULT	50 10 359 807	457220	20026913	81-37933-00
109763	25,00	49,70	10,5/15	AS W	FPM	81444	gearbox	DB	000 267 0297	457290		
113827	139,00	175/205,00	11/16,30	SP	FPM	113828	wheel hub	MAN	81 96503 6000	457300	12019683	
93430	125,00	150,00	14,00	AS SP	NBR	93429	crankshaft	SCANIA	1 334 535	457590	12016695	
95097	125,00	150,00	15/13	A/BS WD	FPM	95098		DB	016 997 7747	457620	19020065	81-35109-00
114633	110,00	140,00	13,00	A/BS	NBR	114414	wheel hub	DB	017 997 1147	457680	12015500	
84224	120,00	150,00	15/12	AW/BS	NBR	84716	wheel hub	DB	019 997 4847	457710		
47289	48,00	65,00	12,00	B	NBR	47290		DB	008 997 1246	460915		
47406	48,00	65,00	12,00	B	NBR	47290		DB	011 997 8246	460915		
47481	30,00	52,00	9,00	C	NBR	95183	crankshaft	DB	001 997 8447	462829	01033894	
82924	25,00	40,00	10,00	AS W RD	FPM	82793	fuel injection	DEUTZ	241 9323	462977		
94250	45,00	62,00	10,00	A/BS F	FPM	94249	engine	DEUTZ	418 2347	462994		
47573	50,00	67,50	13,5/8	SP	NBR	48017	engine	DB	005 997 4447	464872	01019452	81-35079-00

dph-no	dim 1	dim 2	dim 3	Style	Material	dph oil seal no.	Application	Type	OEM-NO	Eling	Corteco	Reinz
4480	52,00	68,00	10,00	AS RD W	MVQ	16052	crankshaft	VOLVO	1 276 425	465194	15012624	
33553	52,00	68,00	10,00	AS RD W	MVQ	16052	crankshaft	VOLVO PC	1 276 424	465194	15012624	81-25587-00
84412	43,00	58,00	7,00	A/B RD	FPM	37533	automatic gearbox	DB	010 997 4947	466042	01020045	
48185	43,00	58,00	7,00	A/B RD	FPM	37533	gearbox automatic	DB	010 997 5047	466042	01020045	
114047	42,00	53,00	7,00	AS RD W	FPM	97916	crankshaft	FORD	1 067 029	467860	01015834	
97917	42,00	53,00	7,00	AS RD W	FPM	97916	crankshaft	FORD	1 663 822	467860	01015834	81-33581-00
47031	59,00	72,00	12/12,50	AW/BS	NBR	15259	transmission shaft	DB	005 997 7146	467871	12012242	81-35081-00
3909	59,00	72,00	12/12,50	AW/BS	NBR	15259	transmission shaft	DB	007 997 3547	467871	12012242	81-35081-00
15260	45,00	85,30	9,5/14,00	A W WD	ACM	6343	differential	DB	003 997 8347	467995	01019449	
111512	95,00	116,50	11,00	SP	FPM	113829	wheel hub	MAN	81 52403 6005	473310		
109220	35,00	48,00	10,00	A/BS W RD	FPM	81442	crankshaft	VW	054 115 147 B	475961	12010739	81-24292-10
97397	55,00	68,00	8,00	A/BS RD	FPM	97403		OPEL	638 196	477010	12015711	81-34158-00
109518	140,00	165,00	9,5/12	AS WD SP	FPM	109519	crankshaft	DB	016 997 7547	477140	01019879	
109784	100,00	120,00	11/16,5	BS SP	NBR	109788	wheel hub	DB	022 997 3447	477860	01030116	
47746	60,00	90,00	10,00	A	NBR	18510	crankshaft	DB	303 997 1047	479004	12011002	
47479	62,00	80,00	10,00	C	NBR	51708	front axle	DB	001 997 7747	484300	12003292	
47049	62,00	80,00	10,00	C	NBR	51708	front axle	DB	006 997 2646	484300	12003292	
96080	62,00	80,00	10,00	C	NBR	51708	front axle	MAN	06 56279 0147	484300	12003292	
111280	132,00	160,00	10,00	B WD	FPM	111357	crankshaft	MAN	06 56289 0387	485890	12020156	
94336	18,00	32,00	6,00	AS RD	ACM	94335	oil pump	OPEL	646 268	490800	12015450	
114620	100,00	124,00	12,00	AS RD SP	PTFE/ACM	114410	crankshaft	DAF	1340 321	493330	15027586	81-29052-10
51890	125,00	150,00	15,00	AS/BW LD	FPM	51252	crankshaft	DAF	0682 962	493360		
109156	125,00	150,00	15,00	AS/BW LD	FPM	51252	crankshaft	DAF	1275 082	493360		81-24476-20
46987	65,00	80,00	8/5,20	B	FPM	47954		DB	004 997 1246	493902		
47268	65,00	80,00	8/5,20	B	FPM	47954	crankshaft	DB	007 997 7946	493902	20020508	
47478	65,00	85,00	10,00	A	NBR	18565	crankshaft	DB	001 997 7547	494402		
47519	65,00	85,00	10,00	A	NBR	18565	crankshaft	DB	003 997 3347	494402	12011007	
47529	65,00	85,00	10,00	A	NBR	18565	crankshaft	DB	003 997 6947	494402	12011007	
61045	68,00	85,00	10,00	A	NBR	18565	crankshaft	DEUTZ	116 5286	494402		
82461	65,00	85,00	10,00	A W LD	MVQ	82464	crankshaft	PORSCHE	999 113 05750	494500		81-15332-20
82536	105,00	120,00	8,00	BS	NBR	81356	wheel hub	BPW	02 5664 04 00	495590		
93811	115,00	136,70	8/12	AS SP	NBR	113537	axle	BPW	02 5664 57 00	495600	01016766	
111400	110,00	130,00	13,00	A/BS LD	PTFE	109691	crankshaft	MAN	51 01510 0218	503208	20029606	81-33801-00
110863	35,00	47,00	7,00	A W RD	FPM/ACM	112614	crankshaft	RENAULT	77 00 854 842	504483	12013859	81-35506-00
117052	85,00	110,00	12/17	AW/BS	FPM	117051	differential	DB	014 997 1246	504560	01033971	

dph-no	dim 1	dim 2	dim 3	Style	Material	dph oil seal no.	Application	Type	OEM-NO	Eling	Corteco	Reinz
98170	40,00	58,00	10,00	A W WD	FPM/ACM	117114	rear axle	PEUGEOT	3121 44	504581	20020137	81-38026-00
109075	36,00	50,00	7,00	AS W RD	FPM	109074	camshaft	PEUGEOT	0236 44	505366	20015457	81-34403-00
93435	42,00	66,00	6,00	BS W RD	FPM/ACM	93433	crankshaft	PEUGEOT	0514 72	505740	20018081	81-31863-00
110810	30,00	42,00	7,00	AS RD	FPM	51727	manual transmission	RENAULT	77 00 749 395	505838	12011839	81-17539-50
115409	35,00	50,00	8,00	AS W RD	FPM/ACM	97204	crankshaft	RENAULT	77 00 859 691	507806	12013459	
82436	80,00	100,00	8,00	AS W LD	FPM/ACM	82435	crankshaft	RENAULT	77 00 859 692	507822	12015352	
117108	90,00	110,00	7,00	AS W LD	FPM/ACM	117108	crankshaft	PEUGEOT	0127 28	508209	20015455	81-25925-00
109055	42,00	62,00	7,00	AS W RD	FPM/ACM	109055	camshaft	PEUGEOT	032 612	508233	20015456	
115415	85,00	105,00	8,00	AS W LD	ACM/FPM	109243	camshaft	RENAULT	77 03 087 190	508462	12015424	81-23708-50
83885	85,00	105,00	8,00	AS W LD	ACM/FPM	109243	crankshaft	VOLVO PC	3 287 542-9	508462		81-23708-50
114678	50,00	68,00	10,00	A/B W RD	FPM	82470	crankshaft	PEUGEOT	0127 11	508470	12013865	81-16737-20
82471	50,00	68,00	10,00	A/B W RD	FPM	82470	crankshaft	RENAULT	77 00 719 274	508470	12013865	81-16737-20
82472	50,00	68,00	10,00	A/B W RD	FPM	82470	crankshaft	RENAULT	77 00 866 877	508470	12013865	81-16737-20
110599	30,00	40,00	7,00	AS RD W	FPM	47982	camshaft	OPEL	646 260	508489		81-15512-50
94507	30,00	40,00	7,00	AS RD W	FPM	47982	camshaft	RENAULT	77 03 087 189	508489	12014403	81-15512-50
115416	25,00	42,00	7,00	AS W RD	FPM	112618	camshaft	RENAULT	77 03 087 192	508544	12015425	81-26389-30
112618	25,00	42,00	7,00	AS W RD	FPM	112618	camshaft	VOLVO PC	3 287 556-9	508544		81-26389-30
115417	22,00	45,00	7,00	AS W LD	FPM	112607	camshaft	RENAULT	77 03 087 191	508608	20015738	81-26392-10
34202	70,00	90,00	10,00	AS LD	MVQ	50760	crankshaft	VW	113 105 245 FS	513326		81-15287-10
113666	90,00	110,00	13,00	AS W	FPM	113665	crankshaft	MAN	06 56289 0183	514950	20016781	
112977	150,00	180,00	15,00	A/B W LD	PTFE/ACM	112978		VOLVO	8 148 259	515800		
97925	47,60	66,70	11,30	AS W RD	AEM/PTFE	111282	crankshaft	FORD	1 087 567	516406	15015977	
113843	139,00	170,00	11,00	B LA SP	FPM	113842	crankshaft	MAN	81 96503 0445	517130	12019163	
47397	115,00	140,00	13,00	CS	NBR	51724	front axle	DB	011 997 5446	518166	12003473	81-35102-00
35150	115,00	140,00	13,00	CS green	NBR	51724	front axle	MAN	06 56289 0037	518166	12003473	81-35102-00
115988	127,00	150,00	12,00	A LD	MVQ	50795	crankshaft	VOLVO	471 056-2	518360		
110486	127,00	150,00	12,00	A/BS LD	FPM	94791	crankshaft	VOLVO	477 119-2	518361	12013863	81-26294-10
33649	100,00	130,00	13,00	B	NBR	19869	front-/rear axle	MAN	06 56281 0605	519243		81-35151-00
81610	100,00	130,00	12,00	A	NBR	18831	crankshaft	MAN	06 56289 0315	519243	01018440	
47559	55,00	75,00	9/11	AS	NBR	47977		DB	004 997 9247	522287		
36375	133,30	155,60	14,00	B WD	NBR	36376	wheel hub	VOLVO	944 667-5	522856	12011387	81-35111-00
80881	148,00	168/170,00	32,00	B WD F	NBR	80880	rear axle	VOLVO	944 665-9	522864	12011389	81-35113-00
114664	164,4/168	188 / 190,00	30 /32	BS WD	ACM	50796	wheel hub	VOLVO	1 591 903	522880	12014351	
84628	164,4/168	188 / 190,00	30 /32	BS WD	ACM	50796	wheel hub	VOLVO	944 666-7	522880	12014351	
46810	110,00	140,00	12/21	SP	NBR	82425	front axle	VOLVO	1 587 792	522910	12013870	

dph-no	dim 1	dim 2	dim 3	Style	Material	dph oil seal no.	Application	Type	OEM-NO	Eling	Corteco	Reinz
46716	110,00	140,00	12/19	SP	FPM	117745	front wheel hub	VOLVO	1 089 552	522911	12014742	81-35101-00
114781	93,00	114,00	11,50	AS W LD	PTFE	113679	crankshaft	DB	112 997 0046	524215	20031906	81-37439-00
47512	105,00	130,00	12,00	AW/BS RD vlies	FPM	112532	crankshaft	DB	003 997 0747	524972	12014447	
47025	105,00	130,00	12,00	AW/BS RD vlies	FPM	112532	crankshaft	DB	005 997 5146	524972		
47592	105,00	130,00	12,00	AW/BS RD vlies	FPM	112532	crankshaft	DB	006 997 1647	524972		
47594	105,00	130,00	12,00	AW/BS RD vlies	FPM	112532	crankshaft	DB	006 997 2347	524972	12014447	
47662	105,00	130,00	12,00	AW/BS RD vlies	FPM	112532	crankshaft	DB	009 997 3447	524972	12014447	
47381	105,00	130,00	12,00	AW/BS RD vlies	FPM	112532	crankshaft	DB	011 997 1346	524972		
36222	105,00	130,00	12,00	AW/BS RD vlies	FPM	112532	crankshaft	DB	012 997 7447	524972	12014447	
47419	105,00	130,00	12,00	AW/BS RD vlies	FPM	47978	crankshaft	DB	403 997 0146	524972		
37088	105,00	130,00	12,00	AW/BS RD vlies	FPM	112532	crankshaft	DB	014 997 4647	524973	01016267	81-23301-60
46904	75,00	100,00	12/13,00	BS RD F	FPM	36208	crankshaft	DB	001 997 5246	525316		
47522	75,00	100,00	12/13,00	BS RD F	FPM	36208	crankshaft	DB	003 997 4547	525316		
47544	75,00	100,00	12/13,00	BS RD F	FPM	36208	crankshaft	DB	004 997 3947	525316	12011674	
46997	75,00	100,00	12/13,00	BS RD	FPM	36208	crankshaft	DB	004 997 6046	525316	12011674	
47585	75,00	100,00	12/13,00	BS RD F	FPM	36208	crankshaft	DB	005 997 8247	525316	12011674	
47713	75,00	100,00	12/13,00	BS RD F	FPM	36208	crankshaft	DB	011 997 5647	525316	12011674	
36221	75,00	100,00	12/13,00	BS RD	FPM	36208	crankshaft	DB	011 997 5747	525316	12011674	81-20309-20
47399	75,00	100,00	12/13,00	BS RD F	FPM	36208	crankshaft	DB	011 997 6946	525316		
47400	75,00	100,00	12/13,00	BS RD F	FPM	36208	crankshaft	DB	011 997 7046	525316	12011674	
47415	75,00	100,00	12/13,00	BS RD F	FPM	36208	crankshaft	DB	345 997 7746	525316		
96330	36,00	58,00	15,00	AS2 WD W	NBR	96329	gearbox	VW	020 301 189 F	525359		
50512	38,00	52,00	7,00	AS W RD	FPM	50511	crankshaft	PORSCHE	999 113 33150	525871		81-16847-10
34421	80,00	100,00	12,00	BS RD LA	FPM	34420	crankshaft	SCANIA	338 643	527823	12011821	81-25013-20
81089	50,00	65,20	10,00	AS W WD	ACM	104440	gearbox	VW	020 301 189 H	527858	12016928	
111232	50,00	65,20	10,00	AS W WD	ACM	104440	gearbox	VW	020 301 189 N	527858	12016928	
104441	50,00	65,20	10,00	AS W WD	ACM	104440	gearbox	VW	020 301 189 T	527858	12016928	
46885	75,00	95,00	10,00	A	NBR	6638	crankshaft	DB	000 997 5046	528102		
35697	75,00	95,00	10,00	A blue	NBR	6638	crankshaft	DB	000 997 5646	528102	12011020	
46957	75,00	95,00	10,00	A	NBR	6638	crankshaft	DB	003 997 3046	528102		
34672	75,00	95,00	13,00	CS green	NBR	51719	gearbox	DB	000 997 6347	529001	12013987	81-35086-00
47387	75,00	95,00	13,00	CS	NBR	51719	gearbox	DB	011 997 2546	529001	12013987	
47539	75,00	100,00	10,00	A	NBR	84535	gearbox	DB	004 997 1347	530107	12011021	
114752	75,00	100,00	10,00	A	NBR	84535	wheel hub	IVECO	3851 0549	530107	12011021	
3888	75,00	100,00	10,00	A blue	NBR	84535	gearbox	SCANIA	33 352	530107	12011021	

200

dph-no	dim 1	dim 2	dim 3	Style	Material	dph oil seal no.	Application	Type	OEM-NO	Eling	Corteco	Reinz
47506	75,00	100,00	12,00	B	NBR	18667	wheel hub	DB	002 997 8447	531006		81-35294-00
47507	75,00	100,00	12,00	B	NBR	18667	wheel hub	DB	002 997 8547	531006		
97915	40,00	55,00	8,00	BS WD	ACM	97914	differential	FORD	1 005 745	539580		
4049	80,00	100,00	10,00	A green	NBR	4306	front-/rear axle	DB	004 997 9646	546038	12011026	
47012	80,00	100,00	10,00	A green	NBR	4306	front-/rear axle	DB	005 997 1046	546038	12011026	
110739	80,00	100,00	10,00	A green	NBR	4306	front-/rear axle	IVECO	3850 5699	546038	12011026	
70446	80,00	100,00	10,00	A green	NBR	4306	front-/rear axle	SCANIA	120 979	546038	12011026	
48469	80,00	100,00	10,00	AS W LD	MVQ	48468	crankshaft	LADA	2108 100 5160	546941		
82131	65,00	90,00	13,00	AW/BS RD VL	FPM	84257	crankshaft	DB	014 997 1647	553272	01016759	81-20504-40
109815	65,00	90,00	13,00	AW/BS RD VL	FPM	84257	crankshaft	DB	344 997 7446	553272		
46983	85,00	105,00	10,00	B	NBR	50341	gearbox	DB	004 997 0646	556807	12011340	81-25546-00
35690	85,00	105,00	10,00	B blue	NBR	50341	gearbox	MAN	06 56289 0132	556807	12011340	
35210	85,00	105,00	10,00	B blue	NBR	50341	gearbox	MAN	81 96501 0446	556807	12011340	
82737	85,00	105,00	10,00	B	NBR	50341	gearbox	MAN	81 96502 0247	556807		
80592	60,00	85,00	10,00	A RD	FPM	80591	crankshaft	PORSCHE	999 113 26340	557846		81-21108-20
120386	145,00	175,00	15,00	AW/BS RD	FPM	120442	crankshaft	VOLVO PC	3 825 169	559030		
47716	100,00	120,00	13,00	C	NBR	18825	front axle	DB	011 997 7147	562609	12011400	
97931	62,00	80,00	12,00	BS RD LA	FPM	97930		FORD	6 135 100	562629	12011475	81-23418-10
81138	28,00	38,00	7,00	AS RD	FPM	81139		FORD	6 135 090	562653	12013949	81-26268-00
47578	68,00	85,00	13,00	BS	NBR	95187	rear axle	DB	005 997 6647	562831	01027962	
47581	68,00	85,00	13,00	BS	NBR	95187		DB	005 997 6847	562831		
47584	68,00	85,00	13,00	BS	NBR	95187		DB	005 997 7747	562831		
47446	75,00	95,00	13,00	A/BS	NBR	48021	rear axle	DB	000 997 4647	562866		81-35087-00
47683	75,00	95,00	13,00	A/BS	NBR	48021	rear axle	DB	010 997 5747	562866	12015884	
47689	75,00	95,00	13,00	A/BS	NBR	48021	rear axle	DB	010 997 7147	562866	12015884	
47730	75,00	95,00	13,00	A/BS	NBR	48021	rear axle	DB	013 997 1147	562866	12015884	81-35087-00
47717	100,00	125,00	13,00	A/BS	NBR	48030	front axle	DB	011 997 7247	562874	12015406	
47728	100,00	125,00	13,00	A/BS	NBR	48030	front axle	DB	012 997 9147	562874	12015406	
47690	115,00	140,00	13,00	A/BS blue	NBR	48022	rear axle	DB	010 997 7847	562882	12015887	
47691	115,00	140,00	13,00	A/BS blue	NBR	48022	rear axle	DB	010 997 7947	562882	12015887	
47694	115,00	140,00	13,00	A/BS blue	NBR	48022	rear axle	DB	010 997 8447	562882	12015887	
36223	120,00	140,00	13,00	AW/BS LD	FPM	112531	crankshaft	DB	013 997 1447	562920	12014877	81-23113-00
69541	120,00	140,00	13,00	AW/BS LD	FPM	112531	crankshaft	DB	014 997 1347	562920	12014877	
47737	120,00	140,00	13,00	AW/BS LD	FPM	112531	crankshaft	DB	016 997 0847	562920		
37452	28,00	40,00	7,00	A RD W	FPM	37451	camshaft	BMW	11 14 1 271 415	562939	20020463	81-19159-10

201

dph-no	dim 1	dim 2	dim 3	Style	Material	dph oil seal no.	Application	Type	OEM-NO	Eling	Corteco	Reinz
115878	28,00	40,00	7,00	A RD W	FPM	37451	camshaft	BMW	11 14 1 707 107	562939		
47309	185,00	210,00	13,00	A	NBR	6369	rear axle	DB	009 997 0046	563617	12011099	81-35117-00
47348	185,00	210,00	13,00	A	NBR	6369	rear axle	DB	010 997 0046	563617	12011099	81-35117-00
6477	185,00	210,00	13,00	A blue	NBR	6369	rear axle	DB	304 997 1747	563617	12011099	
47692	120,00	145,00	15/12	A/BS	NBR	48023	wheel hub	DB	010 997 8047	567108	12015886	
47693	120,00	145,00	13,00	CS	NBR	51716	front & rear axle	DB	010 997 8147	567108	12015886	
47695	120,00	145,00	15/12	A/BS	NBR	48023	wheel hub	DB	010 997 8547	567108		
47674	90,00	110,00	13,00	A/BS	NBR	48024	rear axle	DB	010 997 0147	567779	12015249	
47680	90,00	110,00	13,00	A/BS	NBR	48024	rear axle	DB	010 997 5347	567779	12015249	
47696	90,00	110,00	13,00	A/BS	NBR	48024	rear axle	DB	010 997 8647	567779	12015249	
47672	95,00	120,00	13,00	A/BS	NBR	48026	wheel hub	DB	009 997 9247	567787	12015264	
47682	95,00	120,00	13,00	A/BS	NBR	48026	wheel hub	DB	010 997 5547	567787	12015264	
47698	95,00	120,00	13,00	A/BS	NBR	48026	wheel hub	DB	010 997 8847	567787	12015264	
47722	95,00	120,00	13,00	A/BS	NBR	48026	wheel hub	DB	012 997 1147	567787	12015264	
47676	95,00	115,00	13,00	A/BS blue	NBR	48025	wheel hub	DB	010 997 2447	567795	12015263	81-35094-00
47681	95,00	115,00	13,00	A/BS blue	NBR	48025	wheel hub	DB	010 997 5447	567795		81-35094-00
47697	95,00	115,00	13,00	A/BS blue	NBR	48025	wheel hub	DB	010 997 8747	567795	12015263	
37211	85,73	114,33	13/9,5	A/BS RD W	FPM	81284	crankshaft	VOLVO	424 983-5	570495	12013988	81-25952-20
37517	45,00	64,00	12/7	SP WD	NBR	48029	front axle	DB	011 997 5147	578134	12012039	81-35076-00
47714	45,00	64,00	12/7	SP WD	NBR	48029	front axle	DB	011 997 6147	578134		81-35076-00
104542	35,00	62,00	7,00	AS W WD	ACM	84536	camshaft	SCANIA	1 109 870	580202	12014830	81-26592-10
51453	86,00	104,00	11,00	AS W LD	FPM	51452	crankshaft	OPEL	614 817	581879	12010749	81-25517-00
69270	29,90	47,00	8,00	AW RD	FPM	47983	steering	DB	014 997 6347	582689	01034077	
115876	42,00	62,00	12,00	AW/BS RD	FPM	15245	crankshaft	BMW	11 14 1 715 098	586641		
115877	42,00	62,00	12,00	AW/BS RD	FPM	15245	crankshaft	BMW	11 14 1 715 099	586641		
15257	42,00	62,00	12,00	AW/BS RD	FPM	15245	crankshaft	BMW	11 14 1 715 100	586641		81-16004-10
116110	38,00	50,00	7,00	ASW WD	FPM	36116	engine	BMW	11 12 1 284 154	586668		
19977	38,00	50,00	7,00	AS W WD	FPM	36116	engine	BMW	11 12 1 285 609	586668	12015381	81-24641-10
36212	48,00	65,00	10,00	AW/BS RD F	FPM	36203	crankshaft	BMW	11 14 1 274 346	586676	12012045	81-17404-50
61330	48,00	65,00	9,00	AW/BS RD	FPM	61331	crankshaft	BMW	11 14 1 275 466	586676	12012045	
114605	48,00	65,00	10,00	AW/BS RD	FPM	36203	crankshaft	DB	010 997 4247	586676	01026868	
110586	48,00	65,00	10,00	AW/BS RD F	FPM	36203	crankshaft	OPEL	638 269	586676		81-17404-50
93623	36,51	52,48	8,00	AS W	MVQ	80634	crankshaft	FORD	1 614 762	586730	15012245	81-23056-00
80630	36,51	52,48	8,00	AS W	MVQ	80634	crankshaft	FORD	6 139 049	586730	15012245	81-23056-00
37648	34,93	49,96	8,00	AS W WD	MVQ	37652	crankshaft	FORD	6 123 792	586757		81-22700-10

dph-no	dim 1	dim 2	dim 3	Style	Material	dph oil seal no.	Application	Type	OEM-NO	Eling	Corteco	Reinz
61643	113,00	136,00	10,90	A SP	NBR	61642	rear axle	SCANIA	297 999	586781	12014734	
70481	137,00	161,92	15/12	BS WD LA SP	NBR	61646	crankshaft	SCANIA	297 991	586803	12012241	
34427	145,00	170,00	15/20	B SP	NBR	50174	rear axle	SCANIA	291 076	586838	12011388	
50177	145,00	170,00	15/20	B SP	NBR	50174	crankshaft	SCANIA	370 076	586838	12011388	
47646	37,00	61,00	10/14	AW/B RD SP	ACM	47999	differential	DB	008 997 3147	586994	01019477	81-35071-00
47647	37,00	78,30	8,00	AW/B WD SP	ACM	48000	rear axle	DB	008 997 3247	587001	01019475	81-35072-00
69017	37,00	78,30	8,00	AW/B WD	ACM	48000	rear axle	DB	014 997 6047	587001		
84466	37,00	78,30	8,00	AW/B WD SP	ACM	48000	rear axle	DB	020 997 2047	587001	01019475	
112361	55,00	70,00	6/10,5	BS SP	NBR	112368	wheel hub	FORD	1 637 280	587036	12011181	
4073	55,00	70,00	6/10,25	BS SP	NBR	112368	rear axle	FORD	6 043 882	587036	12011181	
36214	35,00	55,00	12,00	AS W RD	ACM	36204	crankshaft	BMW	11 14 1 709 632	587044	12013416	81-19886-10
69285	130,00	160,00	15,00	AW/BS LD	FPM	93307	crankshaft	SCANIA	366 303	587070	12013893	81-25014-10
34428	130,00	160,00	15,00	AS W LD	MVQ	48518	crankshaft	SCANIA	231 938	587079	12013893	81-25014-10
37520	45,00	85,30	9,5/14,00	A W WD	ACM	6343	differential	DB	011 997 8847	587915		81-35148-00
35804	64,90	90,00	10,00	BS RD LA F	FPM	35885		VOLVO	267 268	587958	12013360	
35805	80,00	100,00	10,00	BS LD LA	FPM	35886		VOLVO	267 269	587966	12013361	81-35169-00
110723	80,00	100,00	10,00	BS LD LA	FPM	35886	PB 269	VOLVO	943 704-7	587966	12013361	81-35169-00
69291	90,00	125,25	10,00	BS RD LA	FPM	69290	rear axle	VOLVO	948 642-8	587991	12014746	81-35142-00
69293	80,00	150,00	12/20	SP RD LA	FPM	69292	differential carrier	VOLVO	1 522 894	588008	12014744	81-35129-00
36626	80,00	130,20	12/20	RD LA SP	FPM	82426	automatic gearbox	VOLVO	1 522 895	588016	12014745	81-35131-00
47684	30,00	40,00	7,00	AS RD W	FPM	47982	camshaft	DB	010 997 6147	589993	20020461	
95892	150,00	180,00	17,5/16	BS2 WD	FPM	95891	crankshaft	VOLVO	1 522 896	590738	12011324	
15255	45,00	60,00	9/7	AS RD	ACM	36895	crankshaft	OPEL	638 187	590762	12012250	81-19195-00
80039	45,00	60,00	9/7	AS RD	ACM	36895	crankshaft	OPEL	638 193	590762	12012250	
81062	80,00	98,00	10,00	A/BS LD	FPM	81060	crankshaft	OPEL	614 821	590797	12013882	81-24908-10
94499	80,00	98,00	10,00	A/BS LD	FPM	81060	crankshaft	OPEL	614 830	590797	12013882	81-24908-10
47260	100,00	120,00	13,00	C	NBR	18825	front axle	DB	007 997 3646	592609	12011400	81-35097-00
80493	50,00	65,00	8,00	B WD	FPM	80492	rear axle	VOLVO	1 522 373	597015	20019176	81-35124-00
70480	155,00	180,00	24/29	B SP	FPM	50175	wheel hub	SCANIA	291 463	598925	12011917	
50176	155,00	180,00	24/29	B SP	FPM	50175	wheel hub	SCANIA	370 075	598925	12011917	
47598	30,00	40,00	7,00	AS RD W	FPM	47982	camshaft	DB	006 997 5347	598993	12014403	
82551	30,00	40,00	7,00	AS RD W	FPM	47982	camshaft	DB	018 997 7947	598993	12011131	81-15512-50
35022	110,00	140,00	13,00	C blue	NBR	50802	rear axle	DB	000 997 7446	612103	12011404	
47301	110,00	140,00	13,00	C	NBR	50802	rear axle	DB	008 997 6246	612103	12011404	
47742	125,00	150,00	13,00	CS	NBR	81334	crankshaft	DB	303 997 0147	635600		

dph-no	dim 1	dim 2	dim 3	Style	Material	dph oil seal no.	Application	Type	OEM-NO	Eling	Corteco	Reinz
114643	125,00	150,00	13,00	CS	NBR	81334	crankshaft	MAN	06 56289 0038	635600	12011419	
4500	165,00	190,00	13,00	A blue	NBR	4374	crankshaft	DB	304 997 0447	675407	12011096	
47753	165,00	190,00	13,00	A blue	NBR	4374	front-/rear axle	DB	304 997 1147	675407		
98342	167,00	188/192,50	30 / 32	BS2 WD SP	FPM	98433	wheel hub	VOLVO	1 610 765	693162		81-35134-00
96911	60,45	76,18	10,00	AS LD W	FPM	95897	crankshaft	FORD	1 048 572	693201		81-20286-00
95898	60,45	76,18	10,00	AS LD W	FPM	95897	crankshaft	FORD	6 803 967	693201	12015546	81-20286-00
80013	152,40	120,65	13/12	SP	NBR	80012	front & rear axle	VOLVO	946 026-2	694088		
97203	35,00	50,00	8,00	AS W RD	FPM/ACM	97204	crankshaft	OPEL	646 290	694657	12013459	81-21798-00
15254	77,00	100,10	11,45	AW/BS LD	FPM	15248	crankshaft	OPEL	614 815	694665	12013857	81-20667-30
50705	81,00	100,10	11,45	AW/BS LD	FPM	97870	crankshaft	OPEL	614 816	694673	12010747	81-24077-00
81065	55,00	70,10	5,50	AW/B LD	FPM	51306	camshaft	OPEL	636 839	694711		81-27317-00
50706	55,00	70,10	5,50	AW/B LD	FPM	51306	camshaft	OPEL	638 194	694711		81-27317-00
96024	31,00	50,00	8,00	AS RD	FPM	37865	crankshaft	OPEL	646 289	694739	12013458	
51454	90,00	104,00	11,00	A/BS LD	FPM	93733	crankshaft	OPEL	614 819	694770	12014523	81-27294-10
50704	90,00	104,00	11,00	A/BS LD	FPM	93733	crankshaft	OPEL	614 827	694770		81-27294-10
59233	90,00	104,00	11,00	A/BS LD	FPM	93733	crankshaft	OPEL	614 829	694770	12014523	81-27294-10
96360	90,00	104,00	11,00	A/BS LD	FPM	93733	crankshaft	OPEL	614 840	694770	20033412	
95611	46,00	64,00	8,00	B RD	FPM	47998	gearbox	DB	015 997 0347	701343	12015259	
80070	35,00	48,00	7,00	AS RD	MVQ	36781	crankshaft	OPEL	636 841	702269	20011244	81-24909-10
48086	90,00	110,00	12,00	AW/BS LD	FPM	15246	crankshaft	BMW	11 14 1 706 785	702994	12012579	81-20745-40
109120	90,00	110,00	12,00	AW/BS LD	FPM	15246	crankshaft	BMW	11 14 2 245 364	702994	12012579	81-20745-40
15246	90,00	110,00	12,00	AW/BS LD	FPM	15246	crankshaft	OPEL	614 838	702994		
46886	42,00	65,00	12,00	AS 15 Grad	ACM	37404	differential	DB	000 997 5146	706035	19016590	
70547	22,00	32,00	8,00	AS	NBR	32076	Injection	SCANIA	837 613	711500		
115353	85,00	105,00	11/6,8	AS LD	FPM	115352	crankshaft	RENAULT	77 03 087 224	711720	20018246	81-34417-00
109112	40,00	70,00	11/15	A RD SP	ACM	109227		DB	022 997 9947	745720	01025661	
109981	80,00	100,00	9,00	A LD	PTFE	109980	crankshaft	DB	160 997 0146	745740	20030112	81-35051-00
109979	40,00	62,00	8,00	AS LD SP	PTFE	109978	crankshaft	DB	166 997 0246	745750	20026275	81-35035-00
109583	55,00	75,00	10,00	A/BS RD	ACM	109582	crankshaft	DEUTZ	417 5434	746300	01032068	81-20991-00
109581	105,00	125,00	13,00	A/BS LD	ACM	109580	crankshaft	DEUTZ	417 5433	746310	12019078	81-31440-00
110503	93,00	155,00	15,50	KA	PTFE	114782	crankshaft	DB	611 010 0114	746400	20030144	81-90002-00
80653	42,00	52,00	7,5/8	A/BS W RD	FPM	80652	crankshaft	BMW	11 14 1 714 617	748889	12014607	81-27556-00
109687	66,00	90,00	12,00	BS RD LA	FPM	109690	crankshaft	MAN	51 01510 0228	749983		81-34421-00
81087	88,00	108,00	11,10	AW BS LD	MVQ	80679	crankshaft	FORD	6 126 179	750476	15011269	
80631	88,00	108,00	11,10	AW/BS LD	FPM	80639	crankshaft	FORD	6 165 502	750476	12014402	

dph-no	dim 1	dim 2	dim 3	Style	Material	dph oil seal no.	Application	Type	OEM-NO	Eling	Corteco	Reinz
110485	76,20	101,60	11,90	A/BS RD VL	FPM	94792	crankshaft	VOLVO	477 118-4	754669	01016760	81-31168-00
37061	29,00	50,00	10/7	AW/BS LD	ACM	82254	injection pump	VOLVO	424 580-9	755087	12014476	
81063	26,00	42,00	8,00	A/BS RD	FPM	81064	crankshaft	OPEL	646 267	755141	12013858	
68535	26,00	42,00	8,00	A/BS RD	FPM	81064	crankshaft	OPEL	646 270	755141	12013858	81-27295-00
70548	100,00	120,00	15,00	AW/BS RD F	FPM	82047	crankshaft	DEUTZ	242 1819	756121	12012580	81-25986-20
70549	105,00	130,00	15,00	AW/BS F LD	FPM	82048	crankshaft	DEUTZ	242 1820	756148	12012581	81-23301-40
104477	44,00	62,00	10,00	A/BS RD W	FPM	104499	crankshaft	BMW	11 14 1 312 007	757217		81-36496-00
84269	35,00	50,00	7,00	A/B RD	FPM	50167	crankshaft	FORD	6 165 499	757292		81-25451-10
115457	35,00	50,00	7,00	A/B RD	FPM	50167	crankshaft	PEUGEOT	0807 14	757292	20018100	81-25451-10
96247	42,00	56,00	7,00	AS W RD	FPM	82475	differential	FORD	1 669 254	757497	12014404	
80632	42,00	56,00	7,00	AS W RD	FPM	82475	differential	FORD	6 165 498	757497	12014404	81-51109-30
51953	8,00	14,00	4,00	B	FPM	51952	gearbox	VW	020 311 108 A	758876	01020437	
114565	34,90	62,00	8,00	A/BS LD	ACM	114332	injection pump	VOLVO	1 546 221	760240	12017218	81-33677-00
15252	155,00	180,00	15,00	A/BS LD W	FPM	81702	crankshaft	VOLVO	469 336-2	760315	12015806	81-25934-00
36318	155,00	180,00	15,00	A/BS LD W	FPM	81702	crankshaft	VOLVO	821 755-6	760315	12015806	81-25934-00
82342	70,00	90,00	12,00	AS RD	ACM	82341	crankshaft	DAF	0240 631	760544		
95835	44,00	60,00	10,00	AS W RD	FPM	80654	crankshaft	BMW	11 14 1 308 342	761796	12014608	
80655	44,00	60,00	10,00	AS W RD	FPM	80654	crankshaft	BMW	11 14 1 721 560	761796	12014608	81-28498-00
61393	100,00	124,00	13,00	BS LA LD	FPM	48019	crankshaft	DB	116 997 0246	762172	01029678	81-25268-10
117331	90,00	110,00	15,00	AW BD	FPM	96082		MAN	81 96502 0699	762830		
104115	70,00	90,00	10,00	AW/BS RD	FPM	114379	crankshaft	DAF	1226 734	763144	12014700	81-15287-00
82449	36,00	54,00	7,00	AW/BS RD	FPM	82448	gearbox	DB	015 997 7747	763691	01019913	
114573	36,00	54,00	7,00	AW/BS RD	FPM	82448	gearbox	DB	017 997 1447	763691	01019913	
109059	79,38	95,25	11,00	AW BS LD	MVQ	80680	crankshaft	FORD	1 472 927	763713	15011263	
93703	79,38	95,25	11,00	AW/BS LD	MVQ	80680	crankshaft	FORD	1 614 763	763713	15011263	
93704	79,38	95,25	11,00	AW/BS LD	MVQ	80680	crankshaft	FORD	1 614 764	763713	15011263	
80636	79,38	95,25	11,00	AW/BS LD	FPM	80636	crankshaft	FORD	1 641 893	763713	12015675	
114599	45,00	65,00	10,00	AW/BS RD	FPM	95149	crankshaft	DEUTZ	418 7438	763781	01026520	81-27390-10
94944	38,00	50,00	8,00	A/BS RD	FPM	111535	crankshaft	OPEL	646 269	763918	12014494	81-28236-00
110600	38,00	50,00	8,00	A/BS RD	FPM	111535	crankshaft	OPEL	646 271	763918	12014494	
108819	120,00	140,00	13,00	A/B LD SP	PTFE/ACM	109246	crankshaft	MAN	51 01510 0196	766828	01016688	
70512	120,00	140,00	13,00	A/B LD SP	PTFE/ACM	109246	crankshaft	MAN	51 01510 0206	766828	01016688	81-23113-30
82544	105,00	130,00	12,00	AS W RD SP	PTFE	109245	crankshaft	MAN	51 01510 0197	766852	01017541	81-23112-30
112554	105,00	130,00	12,00	AS W RD SP	PTFE	109245	crankshaft	MAN	51 01510 0226	766852	01017541	
81122	105,00	130,00	12,00	AS W RD SP	PTFE	109245	crankshaft	MAN	51 01510 6004	766852	01017541	81-23112-30

dph-no	dim 1	dim 2	dim 3	Style	Material	dph oil seal no.	Application	Type	OEM-NO	Elring	Corteco	Reinz
82479	42,00	60,00	8,00	A W RD	ACM	59256	crankshaft	PEUGEOT	0514 11	767921	07011550	81-27333-00
80835	145,00	175,00	13,00	AW/B	FPM	59311	rear axle	DB	013 997 5947	768057	12014739	81-35112-00
36646	145,00	175,00	13,00	AW/B	FPM	59311	rear axle	DB	013 997 9447	768057	12014739	
51423	145,00	175,00	14,00	A/BS	NBR	81021	rear axle	DB	013 997 0547	768065	12014740	81-91002-00
94399	145,00	175,00	13,00	A/B W blue	NBR	82427	rear axle	DB	013 997 6447	768065		
51230	145,00	175,00	14,00	A/BS	NBR	81021	rear axle	DB	016 997 5647	768065	12014740	
82113	145,00	175,00	14,00	A/BS W	NBR	81021	rear axle	MAN	06 56289 0332	768065	12014740	
6652	145,00	175,00	14,00	A/BS blue	NBR	81021	rear axle	MAN	06 56289 0335	768065	12014740	81-91002-00
113953	62,00	80,00	10,00	A/BS W blue	NBR	113952	transmission shaft	DB	015 997 0147	801230	12015885	
96899	85,00	105,00	11,00	M6 SP KA	PTFE	109159	crankshaft	VW	028 103 171 B	804850	20033462	
37152	85,00	105,00	11,00	M7 SP KA	PTFE	81520	crankshaft	VW	068 103 171 G-F	804850	20033462	
36647	100,00	130,00	13,00	AS	NBR	4377	front & rear axle	DB	010 997 9046	814172	12000552	
47388	100,00	130,00	13,00	AS	NBR	4377	front & rear axle	DB	011 997 2646	814172	12000552	
47391	100,00	130,00	13,00	AS	NBR	4377	front & rear axle	DB	011 997 3646	814172	12000552	
81075	100,00	130,00	13,00	AW/BS	NBR	61447	front-/rear axle	DB	015 997 4347	814172	12000552	
32639	145,00	175,00	13,00	A/B W blue	NBR	82427	rear axle	MAN	06 56289 0334	817023	12015499	81-91001-00
82537	125,00	143,00	13,00	AS WD W	NBR	80457	wheel hub	BPW	02 5664 26 57	817252	12015710	
82078	145,00	167,00	13,00	AS WD W	NBR	80456	axle	BPW	02 5664 46 57	817260	12013359	
98428	68,00	85,00	10/9,5	A/B RD	FPM	98432	differential	DB	016 997 6647	817449		
93722	55,00	72,00	10,00	AW/BS RD	FPM	93721	crankshaft	BMW	11 14 1 713 722	818364	20020462	
116111	55,00	72,00	10,00	AW/BS RD	FPM	93721	crankshaft	BMW	11 14 1 725 994	818364	20020462	
112638	100,00	125,00	13,00	A/B LD	FPM	112637	crankshaft back	BMW	11 14 1 710 247	818399	20026342	
114622	100,00	125,00	13,00	A/B LD	FPM	112637	crankshaft back	BMW	11 14 1 713 730	818399	20026342	81-27373-00
82322	145,00	175,00	16,00	AW/BS WD	FPM	82321	rear axle	MAN	06 56289 0309	826774	01016698	
93474	145,00	175,00	16,00	AW/BS WD	FPM	82321	rear axle	MAN	06 56289 0386	826774	01016689	
81595	68,00	85,00	10/9,5	A/BS	NBR	96320	differential	DB	016 997 6747	830798	01016877	
84267	95,00	130,00	12/13	AW/BS RD F	FPM	82797	crankshaft	DEUTZ	414 2503	830879	01016936	81-26022-00
84196	135,00	160,00	16/13	AW/BS LD F	FPM	82799	crankshaft	DEUTZ	242 7225	830887	01016937	81-26023-00
82458	45,00	67,00	8,00	ASW RD	FPM	36206	crankshaft	DB	018 997 5247	914924		
48712	45,00	67,00	8,00	ASW RD	FPM	36206	crankshaft	DB	120 997 0346	914924	12012248	81-26248-00
82497	158,00	188,00	14,5/18	KA	FPM	109377	crankshaft	SCANIA	1 363 674	919888	12017426	
37599	140,00	164,00	20/23,50	SP	FPM	50173	rear axle	VOLVO	1 522 372	922277	12014656	
109599	150,00	196,00	16,00			109599	ABS	DB	942 356 0315	458 700		



dph-no	dim 1	dim 2	dim 3	Style	Material	dph oil seal no.	Application	Type	OEM-NO	Elring	Corteco	Reinz
93755	55,00	72,00	10,00	C	NBR	18418	differential	DB	006 997 1246		01001557	
46980	10,00	15,00	3,00	B OF	NBR	47952	front axle	DB	003 997 9846	010804	01002259	81-25545-00
110728	10,00	15,00	3,00	B OF	NBR	47952	front axle	IVECO	112 2949		01002259	
114516	10,00	15,00	3,00	B OF	NBR	47952	front axle	MAN	06 56269 0479	010804	01002259	
114517	10,00	15,00	3,00	B OF	NBR	47952	front axle	MAN	06 56269 0527	010804	01002259	
96085	10,00	15,00	3,00	B OF	NBR	47952	front axle	VOLVO	346 822-0	010804	01002259	
84768	10,00	15,00	3,00	B OF	NBR	47952	crankshaft	ZF	0634 300 185		01002259	
46910	14,00	24,00	7,00	B	NBR	19033	gearbox	DB	001 997 8346	037109	01002369	
47308	15,00	24,00	7,00	B	NBR	17404	manual gearbox	DB	008 997 9846	037133	01002376	
82809	17,00	28,00	7,00	B	NBR	37867	injection pump	DB	004 997 4947		01002391	
47482	25,00	52,00	7,00	B	NBR	17653	crankshaft	DB	001 997 8547	038385	01002458	
35090	25,00	52,00	7,00	B	NBR	17653	crankshaft	MAN	06 56261 1615	038385	01002458	
80376	28,00	47,00	10,00	B	NBR	19153	rear axle	DB	000 997 7547	038660	01002474	81-20307-00
114015	28,00	52,00	7,00	B	NBR	51524	crankshaft	DB	011 997 5447		01002476	
47587	30,00	47,00	8,00	B	NBR	36748	gearbox	DB	005 997 8647	038873	01002484	
36121	40,00	55,00	10,00	B	NBR	18082	transfer gearbox	DB	005 997 8747	044318	01002552	
35206	70,00	90,00	10,00	B	NBR	18162	crankshaft	MAN	81 96501 0308		01002684	
61645	110,00	140,00	12/21	NBR SP	NBR	82425	front wheel hub	SCANIA	300 278		01002741	
47272	165,00	190,00	13,00	BS	NBR	47254	rear axle	DB	007 997 8246	346640	01002772	
47450	52,00	72,00	12,00	BS WD	FPM	47951	gearbox	DB	000 997 6647	006564	01002858	
93238	95,00	115,00	13/12	BS	NBR	93237		DB	013 997 7247		01002889	
47326	165,00	190,00	13,00	BS	NBR	47254	front axle	DB	009 997 1846		01002897	
47385	25,00	32,00	5,00	B OF	NBR	48055	gearbox	DB	011 997 2246	134600	01002919	
117332	25,00	32,00	5,00	B OF	NBR	48055	gearbox	MAN	81 96502 0117	134600	01002919	
117360	25,00	32,00	5,00	B OF	NBR	48055	gearbox	RVI	5000 815 354		01002919	
70020	80,00	100,00	10,00	B	NBR	18683	gearbox	VOLVO	959 042-3		01002942	
114598	45,00	65,00	10,00	C	NBR	18236	crankshaft	DEUTZ	115 4490		01003181	
35020	50,00	65,00	10,00	C	NBR	18319	wheel hub	DB	003 997 2546		01003218	
46954	52,00	72,00	12,00	C	NBR	18376	wheel hub	DB	003 997 1446		01003238	
47030	53,98	76,20	12,5/8	C	NBR	48042	wheel hub	DB	005 997 7046		01003247	
32871	58,00	75,00	12,00	C blue	NBR	50807	gearbox	DB	008 997 1146	043932	01003273	
47022	125,00	150,00	15,00	C	NBR	50804	rear axle	DB	005 997 4446		01003494	
47593	125,00	150,00	15,00	C	NBR	50804	rear axle	DB	006 997 2147		01003494	
32782	145,00	170,00	15,00	C	NBR	18951	crankshaft	MAN	06 56289 0041		01003537	
82503	160,00	180,00	15,00	CS	NBR	81835	crankshaft	SAF	4 373 0005 00		01003556	

dph-no	dim 1	dim 2	dim 3	Style	Material	dph oil seal no.	Application	Type	OEM-NO	Elring	Corteco	Reinz
114665	170,00	190,00	15,00	C	NBR	18976	crankshaft	MAN	06 56289 0143		01003567	
93449	110,00	140,00	13,00	CS	NBR	18871	wheel hub	MAN	06 56289 0236	105422	01003701	
34036	34,00	52,00	8,00	A	NBR	17888	automatic gearbox	DB	008 997 9146	048364	01010901	
82330	85,00	105,00	10,00	B LD	FPM	4047	gearbox	ZF	0750 111 004		01011312	
46902	36,00	58,00	10,00	B	NBR	47974	rear axle	DB	001 997 3446		01011540	
94303	70,00	90,00	12,00	C	FPM	94302	crankshaft	MAN	06 56279 0236		01012087	
22999	50,00	58,00	4,00	BO	NBR	22997	stub axle	DB	011 997 3546		01012190	
95833	50,00	58,00	4,00	BO	NBR	22997	stub axle	MAN	06 56279 0353		01012190	
117362	50,00	58,00	4,00	BO	NBR	22997	stub axle	RVI	5003 087 037		01012190	
117361	50,00	58,00	4,00	BO	NBR	22997	stub axle	RVI	5010 439 195		01012190	
114684	52,00	72,00	8,00	A W	FPM	114349	crankshaft	DB	010 997 7246		01012588	
81801	125,00	160,00	17,00	KA SP	FPM	81798	axle	DAF	0292 766		01015140	
114313	125,00	160,00	17,00	KA SP	FPM	81798	axle	SCANIA	350 984		01015140	
84770	100,00	140,00	15,5/20	KA	FPM	113947	wheel hub	DAF	1278 420		01015141	
94314	100,00	140,00	15,5/20	KA	FPM	113947	wheel hub	VOLVO	1 593 459		01015141	
81796	120,00	160,00	17,50	C SP	NBR	81799	axle	DAF	0678 157		01015143	
113949	100,00	150,00	15/20	KA SP	FPM	113948	crankshaft	DAF	1278 423		01015348	
114317	90,00	140,00	15,5/20	KA	FPM	114316	crankshaft	DAF	1278 421		01015529	
114047	42,00	53,00	7,00	AS RD W	FPM	97916	crankshaft	FORD	1 067 029	467860	01015834	
97917	42,00	53,00	7,00	AS RD W	FPM	97916	crankshaft	FORD	1 663 822	467860	01015834	81-33581-00
93749	28,00	38,00	7,00	A SP	NBR	93748		ZF	7852 033 108		01015867	
114555	28,00	38,00	7,00	A SP	NBR	93748		ZF	7852 033 110		01015867	
37088	105,00	130,00	12,00	AW/BS RD vlies	FPM	112532	crankshaft	DB	014 997 4647	524973	01016267	81-23301-60
110540	120,00	160,00	15,00	AS WD	NBR	110539	wheel hub	RVI	5000 671 980		01016684	
111645	120,00	160,00	15,00	AS WD	NBR	110539	wheel hub	RVI	5000 788 490		01016684	
110002	85,00	125,00	12,00	SP	FPM	110004	differential	DAF	0077 479		01016687	
37179	120,00	140,00	13,00	A/B LD SP	PTFE/ACM	109246	crankshaft	MAN	51 01510 0141		01016688	
108819	120,00	140,00	13,00	A/B LD SP	PTFE/ACM	109246	crankshaft	MAN	51 01510 0196	766828	01016688	
70512	120,00	140,00	13,00	A/B LD SP	PTFE/ACM	109246	crankshaft	MAN	51 01510 0206	766828	01016688	81-23113-30
118372	145,00	175,00	16,00	AW/BS WD	FPM	82321	rear axle	DB	013 997 8946		01016689	
93474	145,00	175,00	16,00	AW/BS WD	FPM	82321	rear axle	MAN	06 56289 0386	826774	01016689	
82322	145,00	175,00	16,00	AW/BS WD	FPM	82321	rear axle	MAN	06 56289 0309	826774	01016698	
82131	65,00	90,00	13,00	AW/BS RD VL	FPM	84257	crankshaft	DB	014 997 1647	553272	01016759	81-20504-40
110485	76,20	101,60	11,90	A/BS RD VL	FPM	94792	crankshaft	VOLVO	477 118-4	754669	01016760	81-31168-00
109146	115,00	136,70	8/12	AS SP	NBR	113537	axle	BPW	02 5664 55 64		01016766	

dph-no	dim 1	dim 2	dim 3	Style	Material	dph oil seal no.	Application	Type	OEM-NO	Elring	Corteco	Reinz
93811	115,00	136,70	8/12	AS SP	NBR	113537	axle	BPW	02 5664 57 00	495600	01016766	
15268	50,00	70,00	10/14	BS2 blue	NBR	59295	front axle	DB	006 997 9646	008028	01016768	81-35292-00
69796	50,00	70,00	10/14	BS2	NBR	59295	front axle	MAN	06 56279 0031	008028	01016768	
69190	64,00	80,00	13,00	AS blue	NBR	61497	front axle	MAN	06 56279 0181	008591	01016769	
81595	68,00	85,00	10/9,5	A/BS	NBR	96320	differential	DB	016 997 6747	830798	01016877	
47580	68,00	85,00	10,00	B RD	FPM	48018	rear axle	DB	005 997 6747		01016878	
46974	52,00	72,00	12,00	BS WD	FPM	47951	gearbox	DB	003 997 7546	006564	01016879	
47718	52,00	72,00	12,00	BS WD	FPM	47951	gearbox	DB	011 997 7447	006564	01016879	
47726	52,00	72,00	12,00	BS WD	FPM	47951	gearbox	DB	012 997 2947	006564	01016879	
84594	68,00	90,00	13,00	A/BS RD	FPM	114378	differential	DB	016 997 6847		01016880	
47655	80,00	100,00	10,00	AW/BS WD	FPM	47995	gearbox	DB	008 997 7547		01016881	
114713	62,00	78,00	10,00	AW/BS LD	FPM	114364	gearbox	DB	014 997 0147		01016882	
114714	62,00	78,00	10,00	AW/BS LD	FPM	114364	gearbox	DB	016 997 3047		01016882	
96990	28,00	37,00	5,00	A W	NBR	96989	crankshaft	ZF	0770 080 457		01016891	
114727	66,67	115,92/125,40	11,9/18,2	BS WD SF	FPM	114372	crankshaft	MAN	06 56279 0275		01016915	
113959	120,00	150,00	15/12	AW/BS	NBR	84716	wheel hub	RVI	0024 472 709		01016917	
96417	105,00	130,00	12/9,5	AW/BS LD	ACM	95476	gearbox automatic	DB	021 997 6447		01016923	
95879	105,00	130,00	12/9,5	AW/BS LD	ACM	95476	gearbox	ZF	0734 319 551		01016923	
111750	105,00	130,00	12/9,5	AW/BS LD	ACM	95476	gearbox	ZF	0750 111 341		01016923	
84267	95,00	130,00	12/13	AW/BS RD F	FPM	82797	crankshaft	DEUTZ	414 2503	830879	01016936	81-26022-00
84196	135,00	160,00	16/13	AW/BS LD F	FPM	82799	crankshaft	DEUTZ	242 7225	830887	01016937	81-26023-00
82339	95,00	120,00	13/12	AW/BS RD F	FPM	82338		DEUTZ	414 6007		01016938	
120472	72,00	90,00	12/9,5	A/B WD	NBR	96429	crankshaft	DB	024 997 5547		01016959	
114503	72,00	90,00	12/9,5	A/B WD	NBR	96429	crankshaft	SCANIA	1 426 876		01016959	
96325	72,00	90,00	12/9,5	A/B WD	NBR	96429	crankshaft	ZF	0734 300 185		01016959	
111632	75,00	95,00	10,00	A/B WD	FPM	47938		DB	017 997 3147		01016962	
114749	75,00	95,00	10,00	A/B WD	FPM	47938	differential	MAN	06 56279 0331	104310	01016962	
115679	60,00	73,00	11/7	AW/BS WD	FPM	115992	wheel hub	VW	2D0 501 317 A		01016963	
80800	190,00	220,00	15,00	B WD	FPM	80797	crankshaft	STEYR	90 003 070 013		01017007	
80799	190,00	220,00	15,00	BS	NBR	80796	crankshaft	STEYR	90 003 070 012		01017008	
84201	42,00	55,00	9,00	B	FPM	48010	front axle	DB	012 997 3747		01017009	
81191	42,00	55,00	9,00	B	FPM	48010	front axle	MAN	06 56279 0297		01017009	
4542	42,00	58,00	7,00	BS	NBR	37347	rear axle	DB	003 997 0547	010197	01017010	
114648	130,00	160,00	16,00	A/BS WD	FPM	81341	crankshaft	MAN	06 56289 0306		01017013	
81568	130,00	160,00	16,00	A/BS WD	FPM	81341	crankshaft	MAN	06 56289 0385	290180	01017013	

dph-no	dim 1	dim 2	dim 3	Style	Material	dph oil seal no.	Application	Type	OEM-NO	Elring	Corteco	Reinz
51884	85,00	105,00	12,00	C	NBR	51710	crankshaft	MAN	06 56289 0181		01017033	
113662	80,00	100,00	12,00	BS	NBR	50348	crankshaft	MAN	06 56289 0179		01017034	
114775	85,00	140,00	15/16,5	KA	FPM/NBR	114401	differential	DAF	0376 992		01017057	
111375	78,00	115,00	13/17	BS RD SP	FPM	111388	differential	DAF	1283 668		01017058	
95475	85,00	145,00	12/37	SP SP	FPM	95864	differential	DB	015 997 4747	447080	01017059	
114776	85,00	145,00	12/37	SP	FPM	95864	differential	MAN	06 56289 0319	447080	01017059	
81121	95,00	115,00	13/12	A/B LD	FPM	93240	gearbox shaft	DB	013 997 7347	141950	01017136	
114609	95,00	115,00	13/12	A/B LD	FPM	93240	gearbox shaft	DB	015 997 4247		01017136	
93432	142,00	180/185,00	7,50	B SP	NBR	93431	crankshaft	SAF	4 266 0028 01		01017375	
82544	105,00	130,00	12,00	AS W RD SP	PTFE	109245	crankshaft	MAN	51 01510 0197	766852	01017541	81-23112-30
112554	105,00	130,00	12,00	AS W RD SP	PTFE	109245	crankshaft	MAN	51 01510 0226	766852	01017541	
81122	105,00	130,00	12,00	AS W RD SP	PTFE	109245	crankshaft	MAN	51 01510 6004	766852	01017541	81-23112-30
112560	142,50	175,00	13/16	AS W WD	NBR	113069	crankshaft	DB	008 997 5847		01017574	
114848	170,00	190,00	15/14	BS blue	NBR	114847	crankshaft	MAN	06 56289 0187		01017575	
94339	53,00	71,00	11,50	BS WD	NBR	94338	rear axle	DB	017 997 3947	151920	01018030	
82967	95,00	115,00	10/9,5	A/B	NBR	82966	crankshaft	MAN	06 56289 0322		01018219	
114608	95,00	115,00	10/9,5	A/B	NBR	82966	crankshaft	MAN	06 56289 0325		01018219	
113671	95,00	120,00	10,00	A/B	NBR	113670	crankshaft	MAN	06 56289 0323		01018243	
47660	105,00	130,00	12/9,5	AW/BS LD	ACM	95476		DB	009 997 0747	314994	01018282	
61236	105,00	130,00	12,00	A/BS LD	FPM	48035	crankshaft	MAN	81 96502 0350	314994	01018282	
114552	25,00	42,00	8,00	A/BS WD	FPM	114328	gearbox	DEUTZ	223 7010		01018323	
114567	35,00	47,00	8/7	AS W WD	ACM	113716	wheel hub	SAAB	87 31 804		01018330	
81610	100,00	130,00	12,00	A	NBR	18831	crankshaft	MAN	06 56289 0315	519243	01018440	
37845	100,00	130,00	12,00	A	NBR	18831	crankshaft	MAN	06 56289 0324		01018440	
48360	40,00	62,00	10/7	A/BS LD	NBR	37532	transfer gearbox	DB	012 997 8747		01019150	
37121	15,00	21,00	5,00	BS	NBR	37114	gearbox	BMW	23 11 1 204 223		01019151	81-24010-00
108800	15,00	21,00	5,00	BS	NBR	37114	gearbox	VOLVO	947 705	327298	01019151	81-24010-00
94770	21,00	32,00	9,00	B combi	ACM	94769	gearbox	OPEL	714 412		01019153	
47735	45,00	65,00	10,00	AW/B WD	ACM	37514	rear axle	DB	014 997 6247		01019154	
96041	40,00	52,00	7/12,7	SP	NBR	96065	wheel hub	VW	8DO 501 641 A		01019205	
82049	145,00	175/205,00	18/20	special	FPM	82044	rear axle	DB	020 997 0547	147731	01019245	81-91000-00
93637	48,00	64,00	12/6	BS WD	NBR	93636	wheel hub	DB	019 997 8847	293400	01019283	
96443	40,00	55,00	8,00	A/BS LD	FPM	97073		DB	014 997 3547		01019285	
84468	33,00	56,00	11,8/9	A/B WD	ACM	84729	differential	DB	014 997 5747	388180	01019286	
3912	45,00	62,00	10/12	BS	NBR	15244	front axle	DB	003 997 9346		01019288	

dph-no	dim 1	dim 2	dim 3	Style	Material	dph oil seal no.	Application	Type	OEM-NO	Elring	Corteco	Reinz
48411	35,00	52,00	7,00	A RD	FPM	48410	automatic gearbox	BMW	23 12 1 220 619		01019289	
6653	30,00	43,00	8/5,50	AS SP blue	NBR	32849		DB	009 997 0147		01019307	
47398	21,00	33,00	8/9,50	AS blue	NBR	36731	steering	DB	011 997 6746	007544	01019308	
95238	18,00	30,00	6,4/8,1	AS W SP	NBR	95237	gearbox	VW	020 301 227 D		01019317	
94352	52,00	65,00	9/6	A/BS SO blue	NBR	94351	crankshaft	DB	014 997 7047		01019318	
46949	110,30	133,30	12	C	NBR	46950	front axle	DB	002 997 6446	210382	01019319	
47516	110,30	133,30	12/10	C	NBR	68848	front axle	DB	003 997 2247	210382	01019319	
84205	110,30	113,30	12/10	C	NBR	68848	front axle	DB	016 997 6347		01019319	
37131	30,00	42,00	8,00	AS	NBR	19424	crankshaft	DB	002 997 7246		01019320	
95654	145,00	175,00	17/21	A/BS2 WD SP	FPM	95653	wheel hub	DB	020 997 3947	022850	01019352	81-35223-00
15260	45,00	85,30	9,5/14,00	A W WD	ACM	6343	differential	DB	003 997 8347	467995	01019449	
47556	40,00	70,00	12/16	BS RD	FPM	48015		DB	004 997 7247		01019450	
47573	50,00	67,50	13,5/8	SP	NBR	48017	engine	DB	005 997 4447	464872	01019452	81-35079-00
114677	50,00	67,50	13,5/8	SP	NBR	48017	engine	DB	005 997 7447		01019452	
82508	45,00	85,30	9,5/18,5	A W WD	ACM	82404		DB	006 997 6747		01019454	
47475	65,00	85,00	10,00	B	FPM	47474		DB	001 997 6647		01019455	
46938	26,00	42,00	10,00	AS	NBR	19376	steering	DB	002 997 4346	006297	01019456	
47563	75,00	95,00	10/9,50	B WD	FPM	4380	transfer gearbox	DB	005 997 0947	327263	01019459	
81190	75,00	95,00	10/9,50	B WD	FPM	4380	transfer gearbox	MAN	06 56279 0215	327363	01019459	
47324	75,00	95,00	12,50	BS	NBR	50347	camshaft	DB	009 997 1546	008370	01019460	
48119	75,00	95,00	12,50	BS	NBR	50347	camshaft	MAN	06 56279 0183	008370	01019460	
114679	50,00	70,00	9,00	A/B WD	FPM	112583	crankshaft	DEUTZ	432 2445		01019463	
112584	50,00	70,00	9,00	A/B WD	FPM	112583	crankshaft	SCANIA	1 104 500		01019463	
113669	76,00	94,00	9,00	A/B	NBR	113668	crankshaft	MAN	06 56279 0315		01019465	
109808	76,00	100/137,00	10/15,5	SP	FPM	109812	ABS with pulse wheel	MAN	81 52403 6000		01019466	
47647	37,00	78,30	8,00	AW/B WD SP	ACM	48000	rear axle	DB	008 997 3247	587001	01019475	81-35072-00
84466	37,00	78,30	8,00	AW/B WD SP	ACM	48000	rear axle	DB	020 997 2047	587001	01019475	
112365	47,00	78/82,00	11,00	A/BS SP RD W	ACM	109482	differential	DB	020 997 6347		01019476	
47646	37,00	61,00	10/14	AW/B RD SP	ACM	47999	differential	DB	008 997 3147	586994	01019477	81-35071-00
93635	37,00	61,00	10/14	AW/B RD SP	ACM	47999	differential	DB	020 997 1947		01019477	
98109	37,00	61,00	10/14	AW/B RD SP	ACM	47999	differential	DB	023 997 9047	268420	01019477	
113976	75,00	95,00	10/9,50	B WD	FPM	4380	differential	RVI	5010 319 684		01019480	
114635	110,00	140,00	15,5/20	KA	FPM	114416	gearbox	DAF	0893 004		01019705	
82535	125,00	142,00	13,00	AS W WD	NBR	82534	crankshaft	BPW	02 5664 28 57	292650	01019878	
109518	140,00	165,00	9,5/12	AS WD SP	FPM	109519	crankshaft	DB	016 997 7547	477140	01019879	

dph-no	dim 1	dim 2	dim 3	Style	Material	dph oil seal no.	Application	Type	OEM-NO	Elring	Corteco	Reinz
114652	135,00	175,00	15,5/20	KA	NBR	114420	crankshaft	MAN	06 56289 0268	357170	01019880	
114464	85,00	150/169,00	12/31,5	BS RD SP	FPM	114404	crankshaft	MAN	06 56289 0266		01019881	
114604	46,00	68,00	12,00	A/BS RD	FPM	114340	gearbox	DB	010 997 2146		01019885	
47357	160,00	180,00	10,00	A/BS	NBR	94701	front axle	DB	010 997 3146	008672	01019887	
47384	160,00	180,00	10,00	A/BS	NBR	94701	front axle	DB	011 997 1846	008672	01019887	
47723	160,00	180,00	10,00	A/BS	NBR	94701	front axle	DB	012 997 1947	008672	01019887	
80826	160,00	180,00	10,00	A/BS	NBR	94701	front axle	DB	015 997 5747	008672	01019887	
51458	160,00	180,00	10,00	A/BS	NBR	94701	front axle	MAN	06 56289 0050	008672	01019887	
83892	160,00	180,00	10,00	A/BS	NBR	94701	front axle	MAN	06 56289 0366	104480	01019887	
47383	160,00	180,00	10,00	A/B WD	NBR	94702	front axle	DB	011 997 1746		01019888	
47724	160,00	180,00	10,00	B	NBR	68846	front axle	DB	012 997 2047	008818	01019888	
95981	160,00	180,00	10,00	A/B WD	NBR	94702	front axle	DB	015 997 5847	104470	01019888	
35155	160,00	180,00	10,00	A/B WD blue	NBR	94702	front axle	MAN	06 56289 0052		01019888	
113667	160,00	180,00	10,00	A/B WD	NBR	94702	front axle	MAN	06 56289 0365	104470	01019888	
82449	36,00	54,00	7,00	AW/BS RD	FPM	82448	gearbox	DB	015 997 7747	763691	01019913	
114573	36,00	54,00	7,00	AW/BS RD	FPM	82448	gearbox	DB	017 997 1447	763691	01019913	
82228	35,00	50,00	8/5,50	BABSL	NBR	4485	crankshaft	DB	016 997 2047		01019970	
113149	75,00	95,00	9,5/10	A/BS	NBR	114110	differential	DB	017 997 3047	104320	01020042	
69845	75,00	95,00	9,5/10	A/BS	NBR	114110	differential	MAN	06 56279 0335	104320	01020042	
114751	75,00	95,00	10/15	A/BS WD	FPM	114388	differential	DB	020 997 3347		01020043	
84412	43,00	58,00	7,00	A/B RD	FPM	37533	automatic gearbox	DB	010 997 4947	466042	01020045	
48185	43,00	58,00	7,00	A/B RD	FPM	37533	gearbox automatic	DB	010 997 5047	466042	01020045	
112564	73,00	93,00	10/12,5	A/B WD	ACM	113928	differential	DB	014 997 9747		01020048	
118552	26,00	34,00	4,5/7	AS SF	NBR	116002	crankshaft	DAF	0066 322		01020066	
84675	26,00	34,00	4,5/7	AS1 SF	NBR	116002	crankshaft	ZF	0770 080 252		01020066	
117206	26,00	34,00	4,5/7	AS1 SF	NBR	116002	crankshaft	ZF	0770 198 134		01020066	
112559	28,00	40,00	8/6,00	AS SP	NBR	36704	steering	DB	014 997 6947		01020082	
80383	35,00	50,00	7,00	A/B RD	FPM	50167	crankshaft	DB	010 997 4547		01020122	
3910	19,05	33,33	7,93	AS blue	NBR	95982	steering	DB	006 997 0247	278556	01020304	
36242	19,05	33,33	7,93	AS blue	NBR	95982	steering	DB	018 997 6047		01020304	
93544	45,00	85,30	9,5/14,00	A W WD	ACM	6343	differential	DB	020 997 2347		01020315	
112364	45,00	85,30	9,5/14,00	A W WD	ACM	6343	differential	DB	022 997 9847		01020315	
84216	44,00	67,00	10,00	AS WD	ACM	84215	differential	BMW	33 13 1 206 111	095311	01020317	
93723	44,00	67,00	10,00	AS WD	ACM	84215	differential	BMW	33 13 1 214 100	095311	01020317	81-29411-00
114497	85,00	110,00	12,00	AW/BS RD	FPM	114429	differential	RVI	5010 319 134		01020413	

dph-no	dim 1	dim 2	dim 3	Style	Material	dph oil seal no.	Application	Type	OEM-NO	Elring	Corteco	Reinz
51953	8,00	14,00	4,00	B	FPM	51952	gearbox	VW	020 311 108 A	758876	01020437	
61407	68,00	90,00	10,00	BS	NBR	95922	differential	MAN	06 56279 0327		01020465	
114730	68,00	90,00	10,00	A/B WD	FPM	114377	differential	DB	017 997 2747		01020466	
96337	80,00	100,00	10,00	AW/BS WD	FPM	47995	differential	DB	017 997 2547		01020467	
80358	80,00	100,00	10,00	AW/BS WD	FPM	47995	differential	MAN	06 56289 0349	104290	01020467	
93378	80,00	100,00	10,00	BS	NBR	42528	rear axle	DB	017 997 7947	104330	01020468	
61486	80,00	100,00	10,00	BS	NBR	42528	crankshaft	MAN	06 56289 0353	104330	01020468	
84478	45,00	50,00	3,00	BO	NBR	42762	hub axle	DB	008 997 7746		01020632	
47349	57,00	75,00	7,5/6	AS K	NBR	48052	front axle	DB	010 997 1746	008664	01020674	
82931	57,00	75,00	7,5/6	AS K	NBR	48052	front axle	MAN	06 56279 0025	008664	01020674	
34018	50,00	70,00	8,00	C blue	NBR	61496	front axle	DB	008 997 9746	108642	01020675	
80537	50,00	70,00	8,00	C	NBR	61496	front axle	MAN	06 56279 0029	108642	01020675	
47375	50,00	65,00	8,00	B	NBR	18316	wheel hub	DB	010 997 9646	041114	01020676	
117369	50,00	65,00	10,00	B	NBR	116340	wheel hub	MAN	06 56279 0138	041114	01020676	81-35124-00
114783	80,00	135/154,00	13,5/18	BS RD SP	FPM	114398	crankshaft	MAN	06 56289 0293	379300	01020677	
80856	90,00	110,00	10,00	A SP	NBR	36835	crankshaft	MAN	06 56289 0321		01020678	
109684	100,00	130,00	12,00	A/B	FPM	109686	wheel hub	MAN	06 56289 0369	374360	01020679	
114687	52,00	97,00	10/18	AS W WD SP	FPM	114353		MAN	81 96502 0676		01020680	
68847	150,00	180,00	8,50	BABSL	NBR	68847					01022273	
82174	32,00	44,00	8/9,50	AS blue	NBR	36730		DB	019 997 5047		01025508	
37033	38,00	54,00	10/11	AS	ACM	94396	differential	BMW	33 12 1 202 126		01025572	
109470	137,00	165,00	13,50	KA SP	FPM/NBR	109471	crankshaft	DB	018 997 3347		01025609	
109112	40,00	70,00	11/15	A RD SP	ACM	109227		DB	022 997 9947	745720	01025661	
116105	34,00	52,00	7,00	A W	ACM	104443	gearbox	VW	096 323 862		01025670	
51472	75,00	95,00	15,50	AW/BS WD	FPM	51471	differential	DB	010 997 0547		01025711	
96336	75,00	95,00	15,50	AW BS WD	FPM	51471	differential	DB	015 997 6847		01025711	
47274	80,00	100,00	12,00	BS	NBR	50348	rear axle	DB	007 997 8446	008354	01025712	
47318	80,00	100,00	12,00	BS	NBR	50348	rear axle	DB	009 997 0746	008354	01025712	
95270	70,00	90,00	10,00	AW/BS WD	FPM	114382	gearbox	DB	017 997 6647		01025713	
93150	45,00	52,00	4,00	BO	NBR	48498	crankshaft	MAN	06 56279 0278		01025733	
117774	38,00	52,00	7,00	B	NBR	20004	crankshaft	IVECO	129 0380		01025734	
114750	75,00	95,00	12/13	A/BS RD Vlies	FPM	112929	crankshaft	DB	011 997 1447		01026179	
82845	156,70	135,00	8/12	special	NBR	82844	crankshaft	BPW	02 5664 58 00		01026187	
109854	72,00	105,00	19,00	SP	FPM/ACM	109858	differential	DB	020 997 0647	023330	01026188	
111757	85,00	110,00	6,00	BS OF SF	NBR	111756	differential	RVI	0024 472 624		01026300	

dph-no	dim 1	dim 2	dim 3	Style	Material	dph oil seal no.	Application	Type	OEM-NO	Elring	Corteco	Reinz
118608	11,75	22,00	12,00	SP	ACM	109065	gearbox	VW	01J321182		01026312	
95130	120,00	145,00	15/12	AW BS WD	FPM	95129	rear axle	DB	015 997 9347	008231	01026319	
98688	56,00	70,00	9,00	A	NBR	98689	crankshaft	DB	014 997 6447		01026320	
47404	50,80	65,00	9/9,50	AS	NBR	48040	steering	DB	011 997 7946	237752	01026321	
109809	81,00	100/137,00	10/15,5	SP	FPM	109813	ABS with pulse wheel	MAN	81 52403 6001	265960	01026330	
111755	85,00	110,00	12,00	AW/BS LD	FPM	111813		RVI	5010 319 135		01026331	
109610	100,00	140/166,00	16/22	SP	NBR	112832	ABS	DAF	1334 961		01026332	
115695	30,00	40,00	7/10	BABSL	NBR	6440		DB	005 997 3547		01026333	
109609	125,00	160/190,00	18/20	KA SP	FPM/PA	109760	ABS	DAF	1335 063		01026336	
112600	70,00	79,00	5,30	B OF SF	NBR	112599	stub axle	DB	020 997 4947	222000	01026376	
114592	45,00	55,00	7,00	B RD	ACM	93690	crankshaft	SCANIA	244 710		01026396	
96428	90,00	120,00	12/9,5	BS RD	FPM	94933	gearbox	ZF	0734 319 127		01026464	
98284	80,00	105,00	10,00	SP	FPM	109859	crankshaft	DB	018 997 7147		01026470	
82990	19,05	30,00	7/8	AS RD blue	NBR	51224	crankshaft	DB	013 997 5847		01026490	
97101	19,05	30,00	7,00	A	MVQ	97100	crankshaft	ZF	0770 080 442		01026490	
114719	64,00	80,00	11,5/16	AS W	NBR	114368	stub axle	DB	022 997 0047		01026493	
95963	8,90	15,80	13,00	SP blue	NBR	104491	crankshaft	DB	008 997 9047		01026500	
114639	120,00	160,00	15,00	AS WD	NBR	110539	crankshaft	DEUTZ	430 4616		01026509	
112544	45,00	65,00	10,00	AW/BS RD	FPM	95149	crankshaft	DEUTZ	241 4248		01026520	81-27390-10
114599	45,00	65,00	10,00	AW/BS RD	FPM	95149	crankshaft	DEUTZ	418 7438	763781	01026520	81-27390-10
109530	45,00	60,00	6,5/8	B OF SF	NBR	112601	steering	SCANIA	1 343 372		01026542	
84231	45,00	62,00	6,5/7	A/B WD	ACM	84230	gearbox	VW	087 409 529 B	091511	01026543	
94048	90,00	110,00	11/9,5	AW/BS LD	FPM	94047	crankshaft	VOLVO	1 669 618		01026642	
94036	65,00	80,00	8,00	B RD LA	FPM	119374	crankshaft	VOLVO	948 826-3		01026644	
47270	68,00	90,00	10,00	BS	NBR	95922	wheel hub	DB	007 997 8146		01026650	
47313	68,00	90,00	10,00	BS	NBR	95922	rear axle	DB	009 997 0546	008303	01026650	
80282	68,00	90,00	12,50	BS	NBR	50346	rear axle	MAN	06 56279 0184	008303	01026650	
96915	105,00	125,00	12/9,5	AW/BS LD SP	FPM	96914	gearbox	ZF	0734 319 459		01026691	
114580	40,00	52,00	7,00	AS W	ACM	114334	gearbox	DB	012 997 8247	221970	01026706	
118917	35,00	52,00	10,00	AS W WD	ACM	112653	crankshaft	SCANIA	1 122 619		01026707	
112654	35,00	52,00	10,00	AS W WD	ACM	112653	crankshaft	SCANIA	1 122 620		01026707	
114690	55,00	62,00	4,00	BO	NBR	114356	stub axle	DB	015 997 3747		01026865	
114605	48,00	65,00	10,00	AW/BS RD	FPM	36203	crankshaft	DB	010 997 4247	586676	01026868	
51950	18,00	27,00	5/8	AS OF	NBR	51949	gearbox	VW	020 141 733	244082	01026910	
113664	81,00	100,00	10,00	A/B	NBR	113663	crankshaft	MAN	06 56289 0320		01027678	

dph-no	dim 1	dim 2	dim 3	Style	Material	dph oil seal no.	Application	Type	OEM-NO	Etring	Corteco	Reinz
97220	125,00	150,00	14,00	SP	FPM	113954	wheel hub	DB	022 997 5247	451100	01027682	
51407	45,00	75,00	10/8	A/BS RD	ACM	51406	differential	BMW	33 12 1 212 461		01027755	
96681	81,00	104,00	11,00	AW/BS RD V	FPM	96231	oil pump	DEUTZ	425 3373	084920	01027762	81-35999-00
96680	130,00	150,00	13,00	AS LD FILZ	FPM/ACM	96235	crankshaft	DEUTZ	425 3333	084610	01027763	81-36001-00
114746	74,00	95,00	11,00	AW/BS RD F	FPM	110391	crankshaft 1012	DEUTZ	425 3372	084790	01027764	81-36021-00
114810	26,00	35,00	11,00	B OF SF blue	NBR	114809	crankshaft	DAF	1236 238		01027785	
82394	145,00	175/205,00	9/14	SP	NBR	80460	rear axle	DB	015 997 4947	147730	01027787	
82320	145,00	175/205,00	9/14	SP	NBR	80460	rear axle	MAN	06 56289 0371	147730	01027787	
115480	85,00	155,00	12/33	SP	FPM	114403	differential	DB	021 997 8547	220660	01027938	
47578	68,00	85,00	13,00	BS	NBR	95187	rear axle	DB	005 997 6647	562831	01027962	
111374	85,00	140,00	13/17	BS SP	FPM	111387	differential	DAF	1287 102		01027965	
47352	26,00	36,00	7,00	AS	NBR	19362	gearbox	DB	010 997 2346		01027966	
94046	26,30	36,20	7,30	AS	NBR	94045		VOLVO	943 741-9	246905	01027966	
114740	70,00	90,00	15,50	AW/BS WD	FPM	114384	transfer gearbox	DB	012 997 5247		01028962	
109592	124,00	150,00	14,30	SP	NBR	109591		DB	021 997 6947	220450	01028965	
93556	85,00	105,00	9,5/13	A/B WD	FPM	93554	differential	DB	017 997 2947	198440	01029594	
117301	85,00	105,00	9,5/13	A/B WD	FPM	93554	differential	MAN	06 56289 0357		01029594	
93555	85,00	105,00	9,5/13	A/BS	NBR	93553	differential	DB	017 997 2847	198430	01029595	
117306	85,00	105,00	13/9,5	A/BS	NBR	93553	differential	MAN	06 56289 0361		01029595	
109216	25,00	40,00	15,00	SP	FPM	109216	gearbox	ZF	0750 112 131		01029609	
98403	26,00	31,00	3,00	B OF	NBR	51395	steering knuckle pin	DB	009 997 6746		01029621	
95044	45,00	52,00	3,00	BO	NBR	95043		DB	002 997 8147		01029642	
114729	68,00	85,00	10,00	A/B WD	FPM	114376	crankshaft	DB	018 997 5147		01029648	
114610	95,00	115,00	13,00	AW/BS WD	FPM	114407	wheel hub	DB	021 997 0047		01029660	
61393	100,00	124,00	13,00	BS LA LD	FPM	48019	crankshaft	DB	116 997 0246	762172	01029678	81-25268-10
114722	65,00	85,00	15,50	A/BS WD	FPM	114369	transfer gearbox	DB	011 997 4447	451120	01029680	
114723	65,00	85,00	15,50	A/BS WD	FPM	114369	transfer gearbox	DB	016 997 4947		01029680	
111669	65,00	90,00	10,00	BS WD	FPM	111748	crankshaft	DAF	0299 521		01029683	
114724	65,00	90,00	10,00	AS W WD	FPM	114370	crankshaft	DB	014 997 0047		01029683	
114611	95,00	115,00	15,50	A/BS LD	FPM	114408	gearbox	DB	023 997 1647	222830	01029684	
114715	62,00	80/86	9/14	KA	NBR	114365	wheel hub	DB	905 997 0246	453910	01029698	
110008	117,50	158,00	17,80	A SP	NBR	113547	crankshaft	BPW	02 5664 68 00		01029718	
113546	126,85	153/157,00	8,80	A SP	NBR	113544	crankshaft	SAF	4 373 0042 01		01029720	
113536	126,85	157,00	8,70	SP	FPM	113535	crankshaft	SAF	4 373 0041 01		01029721	
97053	70,00	90,00	10/14	combi	NBR	114383	gearbox	DB	007 997 9646		01029728	

dph-no	dim 1	dim 2	dim 3	Style	Material	dph oil seal no.	Application	Type	OEM-NO	Etring	Corteco	Reinz
114739	70,00	90,00	10/14	SP	NBR	114383	crankshaft	MAN	06 56279 0064		01029728	
82332	65,00	85,00	10,50	special	FPM	80375	crankshaft	DEUTZ	415 4144		01029745	
117342	52,00	68,00	8,00	A/BS RD	FPM	96995	gearbox	MAN	81 96502 0403	141960	01029746	
96276	25,00	45,00	10,00	AW/BS RD SF	FPM	114330	crankshaft	DEUTZ	414 8959		01029747	
114762	80,00	120,00	13/17	AW/BS RD	FPM	114397	differential	DAF	1287 103		01029753	
114680	50,00	70,00	10,00	C	FPM	114347	crankshaft	ZF	0634 310 209		01029755	
84767	70,00	90,00	10,00	B	NBR	18612	crankshaft	ZF	0734 300 104		01029757	
47667	65,00	90,00	10,00	C	FPM	48036	crankshaft	DB	009 997 7047		01029759	
114725	65,00	90,00	10,00	A	FPM	20627	crankshaft	ZF	0634 310 675		01029759	
109722	90,00	120,00	13/9,5	A/BS WD	FPM	109726	crankshaft	ZF	0750 111 116		01029767	
109228	40,00	70/76,00	11/13,5	AW/BS RD SF	ACM	109304	differential	DB	025 997 0047	152940	01029803	
114496	65,00	85,00	9,5/10	A WD F	NBR	113534	wheel hub	RVI	5010 216 174		01029810	
114631	105,00	130,00	12/17	AW/BS	FPM	114413	crankshaft	MAN	06 56289 0389		01029917	
114773	85,00	110,00	10/14	A/B Duo	FPM	114400	crankshaft	MAN	06 56289 0329		01029919	
114916	85,00	110,00	10/14	A/B Duo	FPM	114400	crankshaft	ZF	0734 319 460		01029919	
114686	52,00	87,00	10/18	AS W WD SP	ACM	114351	crankshaft	MAN	81 96502 0216		01029920	
95803	30,00	42,00	8/7	AS LD	NBR	82139	crankshaft	DEUTZ	116 3273		01029927	81-17539-10
114654	142,00	162,00	10/9,5	AS W RD	FPM	97820	crankshaft	ZF	0734 319 137		01029929	
98174	142,00	162,00	10/9,5	AS W RD	FPM	97820	crankshaft	ZF	0750 111 077		01029929	
94804	42,00	52,00	5,00	B OF	FPM	97353	camshaft	MAN	06 56279 0262		01030090	
112801	143,00	165,00	8,50	BABSL	NBR	112800	crankshaft	DB	011 997 3746		01030092	
114523	18,00	25,00	6,00	B	NBR	21472	crankshaft	DEUTZ	415 8766		01030093	
114594	45,00	62,00	8,00	AW/BS RD	ACM	114336	crankshaft	VOLVO	1 546 480	390010	01030097	
114720	64,90	90,00	9,5/10	A/B RD felt	FPM	112981	gearbox	VOLVO	1 521 431	435820	01030098	
112980	64,90	90,00	9,5/10	A/B RD felt	FPM	112981	gearbox	VOLVO	20 476 025		01030098	
114698	55,00	80,00	8,00	A/BS RD	FPM	114359	gearbox	DB	021 997 1747	456970	01030099	
114699	55,00	80,00	8,00	A/BS RD	FPM	114359	gearbox	DB	021 997 2547	456970	01030099	
113980	120,00	150,00	15,00	AW/BS	FPM	113979	wheel hub	RVI	5010 443 189		01030102	
113938	75,00	95,00	10,00	A	NBR	6638	crankshaft	RVI	5010 216 049		01030103	
114676	50,00	65,00	8,00	AS W LD	FPM	114345	gearbox	DB	021 997 8047		01030104	
114685	52,00	72,00	10,00	B	FPM	114350	crankshaft	MAN	81 96501 0798		01030105	
112249	85,00	145,00	12/32	SP	FPM	114402	differential	DB	018 997 1847	065510	01030110	
109784	100,00	120,00	11/16,5	BS SP	NBR	109788	wheel hub	DB	022 997 3447	477860	01030116	
114758	78,00	135,00	12/21,5	SP	FPM/ACM	114392	differential	DB	018 997 7647	221710	01030117	
111514	15,00	24,00	6/6,5	A DUO	ACM	111515	automatic gearbox	VW	02A 301 227 C		01030118	

dph-no	dim 1	dim 2	dim 3	Style	Material	dph oil seal no.	Application	Type	OEM-NO	Eling	Corteco	Reinz
111744	90,00	110,00	15,50	A/BS WD	FPM	111743	transfer gearbox	DB	015 997 6947		01030122	
114578	39,40	52,00	8,00	AS W LD	ACM	113713	transmission, output	VOLVO PC	1 233 756		01030125	
114689	54,50	80,00	8,00	BS WD	FPM	114355	crankshaft	VOLVO	1 526 008		01030336	
114717	63,50	102,50	6,6/14,8	AS W WD SF	FPM	114367	crankshaft	DAF	0691 048		01030337	
114718	63,50	102,50	6,6/14,8	AS W WD SF	FPM	114367	crankshaft	VOLVO	6 877 944-6		01030337	
114675	50,00	60,00	8,00	BS	NBR	114344	crankshaft	SCANIA	1 324 870		01030356	
104556	15,00	24,00	7,00	A Duo	FPM	104556	steering	ZF			01030475	
113620	10,00	15,00	5,00	B O	FPM	113619	crankshaft	ZF	0734 310 353		01030490	
97818	55,00	68,00	8,00	A/BS WD	FPM	97817	crankshaft	DB	020 997 5347		01030522	
114747	75,00	90,00	10/12,3	AW/BS WD	NBR	114386	wheel hub	DB	024 997 6847		01031066	
111524	16,00	24,00	6/6,5	AS	NBR	48059	gearbox	VW	012 301 457 C		01031067	
114646	130,00	160,00	15,00	AW/BS RD	FPM	97703	crankshaft	VOLVO	1 668 341		01031088	
95603	47,62	80,26	6,8/13,3	A SP W RD	FPM	95622	differential	OPEL	406 774		01031231	
119864	47,62	80,26	6,8/13,3	A SP W RD	FPM	95622	differential	VOLVO	6 877 226-8		01031231	
109481	47,00	78/82,00	11,00	A/BS SP RD W	ACM	109482	differential	DB	024 997 9947		01031603	
109900	45,00	98,3/116,00	10/16,8	SP	NBR	109901		DB	025 997 2647		01031604	
118665	110,23	145,00	10/12	SP	FPM	116318	crankshaft FM9	VOLVO	20 832 385		01031695	
95457	44,45	60,00	7,00	BS SP	NBR	95642	crankshaft	SCANIA	1 345 278		01031705	
95458	38,10	50,00	6,80	AS W SP	NBR	95644	brake camshaft	SCANIA	1 349 089		01031712	
96504	75,00	100,00	9,5/12,5	AS WD SF	NBR	97147	crankshaft	DB	006 997 0547		01031732	
97907	28,00	40,00	7/8,5	AS RD	ACM	97906	gearbox	FORD	6 152 663		01031967	
109583	55,00	75,00	10,00	A/BS RD	ACM	109582	crankshaft	DEUTZ	417 5434	746300	01032068	81-20991-00
114315	120,00	142/150,00	37,00	SP	NBR	114314	wheel hub	DAF	0500 162		01032389	
113539	176,70	155,00	8/12	AS SF	NBR	113538	crankshaft	BPW	02 5664 59 00		01032459	
115614	48,00	68,00	9,30	A/BS	NBR	117963	magnetic oil seal	DB	203 330 0060	366230	01032572	
118609	12,00	16,00	3,00	A O W	NBR	113618	crankshaft	DEUTZ	103 2872		01032872	
112581	40,00	60,00	9/8	A W WD	FPM	112582	crankshaft	SCANIA	1 120 864		01033144	
114490	145,00	175,00	15,00	A W	ACM	114456	wheel hub	DB	013 997 3546	451110	01033415	
82533	115,00	133,00	13,00	AS W WD	NBR	82532	wheel hub	BPW	02 5664 18 57	216320	01033476	
95505	50,00	65,20	6,5/7,5	SP AS W WD	ACM	95508	gearbox	VW	020 301 189 L		01033845	
33260	8,00	14,00	4,00	B	NBR	33261	speedometer drive	BMW	23 12 1 490 192		01033871	
114491	120,00	150,00	15/20,2	A/BS	NBR	114428	wheel hub	DB	013 997 7346	383260	01033873	
115942	53,00	73,00	10,00	A/BS WD	NBR	117962	magnetic oil seal	DB	025 997 1647		01033874	
47481	30,00	52,00	9,00	C	NBR	95183	crankshaft	DB	001 997 8447	462829	01033894	
109785	75,00	110/134,00	10/17	BS SP	NBR	109790	axle, with pulse wheel	DB	970 997 0446		01033904	

dph-no	dim 1	dim 2	dim 3	Style	Material	dph oil seal no.	Application	Type	OEM-NO	Eling	Corteco	Reinz
117052	85,00	110,00	12/17	AW/BS	FPM	117051	differential	DB	014 997 1246	504560	01033971	
117053	85,00	110,00	12/17	AW/BS	FPM	119376	crankshaft	MAN	06 56289 0394		01033971	
84467	73,00	94,00	9/14	A/B WD	ACM	84728	differential	DB	014 997 7247		01033977	
112517	10,00	18,00	5,00	AS	NBR	112519	gearbox	BMW	24 52 7 509 500		01033982	
69270	29,90	47,00	8,00	AW RD	FPM	47983	steering	DB	014 997 6347	582689	01034077	
114579	39,40	65,00	10,00	A/BS LD	ACM	113725	transfer gearbox	VOLVO PC	9 183 891		01034110	
115203	145,00	175,00	8,00	B SP	NBR	114872	wheel hub	DB	013 997 3646		01034120	
114873	145,00	175,00	8,00	B SP	NBR	114872	wheel hub	DB	014 997 0546		01034120	
115687	90,00	145,00	10/15	A/B SP	FPM	94049	differential	VOLVO	1 673 701	435180	01034125	
114481	82,00	105,00	10,00	AS2	NBR	114447	wheel hub	DAF	1400 080		01034436	
96311	44,45	60,00	10/15	SP	NBR	95643	brake camshaft	SCANIA	1 345 279		01034657	
112590	105,00	140,00	13/12	CS WD	NBR	112591	crankshaft	SCANIA	368 542		01034659	
94055	62,00	80,00	12/11	AS W LD	MVQ	82138	crankshaft	DEUTZ	223 4498	352136	01034681	
118371	28,00	40,00	8/6,00	AS SP	NBR	36704		DB	616 997 0146		01034698	
116809	48,00	73,3/76,50	10,00	B OF SF	NBR	117964	magnetic oil seal	FIAT	4 664 143		01034759	
114493	100,00	120,00	10/9,5	AS2 W WD	FPM	114437	wheel hub	RVI	5000 807 810		01035692	
47371	26,00	37,00	7,00	AS	NBR	32164	gearbox	DB	010 997 7346		01201127	
47007	17,00	28,00	7,00	A	NBR	17447	crankshaft	DB	004 997 8546	050300	01210807	
113644	30,00	47,00	7,00	A WD	FPM	113644	camshaft	VOLVO	3 514 943	135150	01500581	
111760	45,00	55,00	7,00	B WD	NBR	93224	crankshaft	RVI	5000 787 085		07002931	
82479	42,00	60,00	8,00	A W RD	ACM	59256	crankshaft	PEUGEOT	0514 11	767921	07011550	81-27333-00
115082	29,85	47,00	9,9/17	AS2 W RD blue	NBR	114902	differential	PEUGEOT	3121 10		07011583	
115412	27,95	56,00	10,00	ASW RD	ACM	115411	differential	RENAULT	77 03 087 146	050560	07011906	
93531	36,00	50,00	8,00	A W RD	ACM	93530	camshaft	PEUGEOT	0236 21		07012633	81-26244-10
117406	95,00	110,00	10	B WD	NBR	113957	wheel hub	IVECO	8601 4686		07013389	
113958	95,00	110,00	10,00	B WD blue	NBR	113957	wheel hub	RVI	5000 545 227		07013389	
119891	95,00	110,00	10	B WD	NBR	113957	wheel hub	VOLVO	947 271-3		07013389	
84614	80,00	95,00	8,00	A	NBR	35192	crankshaft	DAF	0010 588	043737	07013486	81-35088-00
113982	80,00	95,00	8,00	A W WD	NBR	113981	wheel hub	RVI	5516 015 803		07013486	
114759	80,00	95,00	8,00	A W WD	NBR	113981	wheel accessory kit	VOLVO	947 269-7	043737	07013486	
115081	40,00	58,00	11,30	AS SP WD	ACM	96528	differential	PEUGEOT	3121 27	128250	07015496	
111383	23,00	36,00	6/7	A W RD	NBR	111391		CITROEN	2109.40	131860	07015547	
111817	23,00	36,00	6/7	A W RD	NBR	111391	gearbox	PEUGEOT	2109 40	131860	07015547	
111754	57,00	74,00	12,50	B OF SF	FPM	111753	crankshaft	RVI	5000 790 853		07016381	
113941	100,00	120,00	12,00	AS W WD	NBR	111803	wheel hub	RVI	0024 472 286		07016683	

dph-no	Ab 1	Ab 2	Ab 3	Style	Material	dph oil seal no.	Application	Type	OEM-NO	Elring	Corteco	Reinz
113963	44,00	85,00	10,00	A W WD blue	NBR	113962	rear axle	RVI	5000 391 891		07016685	
113939	110,00	130,00	12,00	A	NBR	18860	wheel hub	RVI	5000 675 159		07016686	
113967	75,00	90,00	8,00	A W WD	NBR	113966	wheel hub	RVI	5000 515 606		07016734	
113965	80,00	100,00	10,00	AS W WD blue	NBR	113964	wheel hub	RVI	5000 392 404		07016735	
113580	85,00	130	17/26	AS RD W SP	FPM/ACM	113571	crankshaft	RVI	5000 675 975		07016736	
113572	85,00	130	17/26	AS RD W SP	FPM/ACM	113571	crankshaft	RVI	5010 534 001		07016736	
113579	85,00	130	17/26	AS RD W SP	FPM/ACM	113571	crankshaft	RVI	5010 534 863		07016736	
114774	85,00	130,00	17/26	AS RD W SP	FPM/ACM	113571	crankshaft	VOLVO	3 152 027		07016736	
113970	53,00	97,00	8,00	A W WD	NBR	113969	wheel hub	RVI	5000 546 916		07016775	
110737	30,00	42,00	6/6,8	BABSL WD	NBR	84542	injection pump	IVECO	819 4388		11014231	
84543	30,00	42,00	6/6,8	BABSL WD	NBR	84542	injection pump	SCANIA	280 759		11014231	
81380	28,00	40,00	7,00	AS W WD	MVQ	84575	crankshaft	STEYR	90 003 070 014		11029673	
81846	15,00	24,00	7,00	AS	NBR	97768	gearbox	VW	001 301 227 D		12000044	
70449	28,00	38,00	7,00	A	NBR	17693	steering	SCANIA	136 106		12000129	
114564	32,00	45,00	7,00	A	NBR	17829	wheel hub	DAF	0662 004		12000157	
47434	32,00	45,00	7,00	A	NBR	17829	wheel hub	DB	000 997 1147	227609	12000157	
34917	15,00	24,00	7,00	AS blue	NBR	97768	gearbox	VW	001 301 227		12000444	81-15293-10
47509	22,00	32,00	7/8	AS	NBR	48039	crankshaft	DB	002 997 9547		12000459	
70450	30,00	47,00	7,00	AS	NBR	17741	transfer gearbox	SCANIA	139 023		12000480	
46760	100,00	130,00	13,00	AW/BS	NBR	61447	front-/rear axle	DB	009 997 6747	232459	12000552	81-33861-00
36647	100,00	130,00	13,00	AS	NBR	4377	front & rear axle	DB	010 997 9046	814172	12000552	
47388	100,00	130,00	13,00	AS	NBR	4377	front & rear axle	DB	011 997 2646	814172	12000552	
47391	100,00	130,00	13,00	AS	NBR	4377	front & rear axle	DB	011 997 3646	814172	12000552	
81075	100,00	130,00	13,00	AW/BS	NBR	61447	front-/rear axle	DB	015 997 4347	814172	12000552	
113661	120,00	140,00	13,00	AS	NBR	42932	crankshaft	MAN	06 56289 0223		12000556	
81485	70,00	90,00	10,00	A LD	ACM	81487	crankshaft	VW	113 105 245 F	042102	12001482	81-15287-30
111771	74,00	90,00	10,00	A/BS LD	ACM	111770	crankshaft	FIAT	4000 2740		12001483	
111787	30,00	43,00	8,00	A/BS RD	FPM	111786	camshaft	ALFA	6080 5219	440730	12001538	
111774	74,00	90,00	10,00	A/BS LD	FPM	111773	crankshaft	FIAT	6080 5182	440830	12001540	
114484	95,00	114,00	14,00	C WD	ACM	114439	wheel hub	IVECO	4010 0093		12001579	
117410	100,00	130,00	14,00	C WD	ACM	114451	crankshaft	IVECO	4010 0110		12001580	
114506	100,00	130,00	14,00	C WD	ACM	114451	crankshaft	IVECO	4010 0113		12001580	
114653	140,00	170,00	14,00	A/CS WD W	ACM	81343	crankshaft	MAN	06 56282 1409		12001584	
84541	75,00	90,00	10/11	BABSL	NBR	84540	crankshaft	SCANIA	294 275		12001716	
112550	45,00	65,00	10,00	B	NBR	51487	gearbox	IVECO	4000 0370		12001744	

dph-no	dim 1	dim 2	dim 3	Style	Material	dph oil seal no.	Application	Type	OEM-NO	Elring	Corteco	Reinz
47033	20,00	28,00	6,00	A	NBR	19212	crankshaft	DB	005 997 7746		12001989	
114524	20,00	28,00	6,00	A	NBR	19212	crankshaft	MAN	06 56269 0578		12001989	
110092	75,00	100,00	12,00	AS W	NBR	113611	crankshaft	VOLVO PC	968 844-1		12002219	
34425	90,00	110,00	14,00	BS	NBR	81437	differential	SCANIA	214 008		12002888	
47479	62,00	80,00	10,00	C	NBR	51708	front axle	DB	001 997 7747	484300	12003292	
47049	62,00	80,00	10,00	C	NBR	51708	front axle	DB	006 997 2646	484300	12003292	
96080	62,00	80,00	10,00	C	NBR	51708	front axle	MAN	06 56279 0147	484300	12003292	
47397	115,00	140,00	13,00	CS	NBR	51724	front axle	DB	011 997 5446	518166	12003473	81-35102-00
35150	115,00	140,00	13,00	CS green	NBR	51724	front axle	MAN	06 56289 0037	518166	12003473	81-35102-00
46846	115,00	150,00	13,00	C	NBR	18892	rear axle	DB	004 997 7745	044660	12003475	
84217	30,00	42,00	7,00	AS RD	FPM	51727	manual transmission	BMW	23 12 1 205 186	277142	12010674	
109073	30,00	42,00	7,00	AS RD	FPM	51727	camshaft	FIAT	4000 4240	277142	12010674	
112748	40,00	52,00	9,00	AS W WD	ACM	70817	gearbox	VW	014 409 399 B		12010684	
4056	40,00	52,00	9,00	AS W WD	ACM	70817	gearbox	VW	014 409 399 D	094358	12010684	
50178	54,00	82,00	11,45	AS LD	ACM	4235	crankshaft	OPEL	614 814	231665	12010693	81-21343-00
4236	54,00	82,00	11,45	AS LD	ACM	4235	crankshaft	OPEL	614 818	231665	12010693	81-21343-00
51384	35,00	48,00	10,00	A/BS W RD	FPM	81442	crankshaft	VOLVO PC	1 257 113	294357	12010739	81-24292-10
51383	35,00	48,00	10,00	A/BS W RD	FPM	81442	crankshaft	VW	034 115 147 A		12010739	
109220	35,00	48,00	10,00	A/BS W RD	FPM	81442	crankshaft	VW	054 115 147 B	475961	12010739	81-24292-10
81442	35,00	48,00	10,00	A/BS W RD	FPM	81442	crankshaft	VW	069 115 147 C	294357	12010739	81-24292-10
47486	45,00	74,5/79,50	12/13	A SP RD	FPM/ACM	47997	crankshaft	DB	002 997 0847	309028	12010743	
47588	45,00	74,5/79,5	12/13	A SP RD	FPM/ACM	47997	crankshaft	DB	005 997 9047	312010	12010743	
47640	45,00	74,5/79,5	12/13	A SP RD	FPM/ACM	47997	crankshaft	DB	008 997 1547	309028	12010743	
47641	45,00	74,50	12/14,50	A SP RD	FPM/ACM	47997	crankshaft	DB	008 997 1647	309028	12010743	
36153	45,00	74,5/79,5	12/13	A SP RD	FPM/ACM	47997	crankshaft	DB	009 997 4547	309028	12010743	
48037	45,00	74,5/79,5	12/13	A SP RD	FPM/ACM	47997	crankshaft	DB	009 997 8547	312010	12010743	
47707	45,00	74,5/79,5	12/13	A SP RD	FPM/ACM	47997	crankshaft	DB	011 997 2247		12010743	81-17328-20
113877	47,63	65,07	6,35	A WD SF	FPM	114111	crankshaft	IVECO	798 0285		12010744	
96023	81,00	100,10	11,45	AW/BS LD	FPM	97870	crankshaft	OPEL	614 805		12010747	
50705	81,00	100,10	11,45	AW/BS LD	FPM	97870	crankshaft	OPEL	614 816	694673	12010747	81-24077-00
97871	81,00	100,10	11,45	AW/BS LD	FPM	97870	crankshaft	OPEL	614 826		12010747	
51453	86,00	104,00	11,00	AS W LD	FPM	51452	crankshaft	OPEL	614 817	581879	12010749	81-25517-00
118512	90,00	110,00	10,00	AS W LD	FPM/ACM	118512	crankshaft	PEUGEOT	0119 06	294683	12010750	
82507	133,35	158,75	12,70	AS LD	FPM	82505	crankshaft	PERKINS	2418 F 475		12010753	
46884	8,00	16,00	7,00	A	NBR	17348	crankshaft	DB	000 997 4646		12010757	

dph-no	dim 1	dim 2	dim 3	Style	Material	dph oil seal no.	Application	Type	OEM-NO	Etring	Corteco	Reinz
46919	8,00	16,00	7,00	A	NBR	17348	crankshaft	DB	002 997 1246		12010757	
33337	14,00	24,00	7,00	A	NBR	17391	crankshaft	OPEL	732 225		12010784	
33283	15,00	24,00	7,00	B	NBR	17404	manual gearbox	DB	001 997 2946	037133	12010790	
70569	15,00	32,00	7,00	A	NBR	70569	wheel hub	MF			12010795	
94044	15,00	35,00	7,00	A W	NBR	94043		VOLVO	958 811-2		12010796	
114520	17,00	28,00	7,00	A	NBR	17447	crankshaft	MAN	06 56260 1106	050300	12010807	
46866	17,00	35,00	7,00	A	NBR	93613	water pump	DB	002 997 8446	054003	12010810	81-17193-00
47561	17,00	35,00	7,00	A	NBR	93613	water pump	DB	005 997 0147	054003	12010810	
33285	18,00	28,00	7,00	A	NBR	17479	crankshaft	DB	001 997 6446		12010816	
33297	18,00	35,00	10,00	A	NBR	17489	injection pump	FORD	1 491 853		12010819	
47028	20,00	32,00	7,00	BABSL	NBR	51422	steering	DB	005 997 5846	037524	12010824	
47602	20,00	35,00	7,00	A	NBR	17512	crankshaft	DB	006 997 7447	106208	12010825	
33650	20,00	35,00	7,00	A	NBR	17512	gearbox	MAN	81 96502 0326	106208	12010825	
47452	20,00	40,00	7,00	A	NBR	17524	crankshaft	DB	000 997 6947		12010826	
46858	22,00	35,00	7,00	A	NBR	17557	crankshaft	DB	000 997 2546	120103	12010836	81-15377-00
117334	22,00	35,00	7,00	A	NBR	17557	crankshaft	RVI	5000 294 202		12010836	
114548	22,00	40,00	10,00	A	NBR	17567	crankshaft	MAN	06 56260 1408	037850	12010838	
21628	25,00	37,00	7,00	A	NBR	17609	crankshaft	DB	004 997 1646	137006	12010848	
33286	25,00	40,00	7,00	A	NBR	17614	crankshaft	DB	001 997 8746		12010850	
47550	25,00	40,00	7,00	A	NBR	17614	crankshaft	DB	004 997 6247		12010850	
70457	25,00	47,00	10,00	A	NBR	68544	crankshaft	SCANIA	170 761	038326	12010858	81-20553-10
84622	25,00	47,00	10,00	A	NBR	68544	crankshaft	DAF	0119 198	038326	12010859	
46937	26,00	37,00	7/8	AS V W	NBR	47945	steering	DB	002 997 3846	006408	12010865	81-35069-00
93265	26,00	37,00	7,00	A	NBR	17672	crankshaft	DB	003 997 9946		12010865	
114554	27,00	37,00	7,00	A	NBR	17672	crankshaft	MAN	06 56269 0458		12010870	
46953	28,00	40,00	7,00	AS	NBR	93614	crankshaft	DB	003 997 1346		12010874	
33338	28,00	40,00	7,00	AS blue	NBR	93614	gearbox	OPEL	902 678	164500	12010874	
114556	28,00	40,00	7,00	AS	NBR	93614	crankshaft	RENAULT	094 83 504 09	164500	12010874	
47444	28,00	52,00	10,00	A	NBR	17714	crankshaft	DB	000 997 4447		12010876	
114558	30,00	40,00	7,00	A	NBR	113776	crankshaft	DAF	0119 199	201006	12010879	
114559	30,00	40,00	7,00	A	NBR	113776	crankshaft	MAN	06 56260 1911	201006	12010879	
84565	30,00	42,00	7,00	A	NBR	17728	crankshaft	DB	005 997 5946		12010880	
47603	30,00	42,00	7,00	A	NBR	17728	crankshaft	DB	006 997 7647	203408	12010880	
114560	30,00	42,00	7,00	A	NBR	17728	crankshaft	MAN	06 56260 1912	203408	12010880	
46935	30,00	50,00	10,00	A	NBR	17754	crankshaft	DB	002 997 3046		12010885	

dph-no	dim 1	dim 2	dim 3	Style	Material	dph oil seal no.	Application	Type	OEM-NO	Etring	Corteco	Reinz
114562	30,00	50,00	10,00	A	NBR	17754	crankshaft	DEUTZ	116 0750		12010885	
114563	30,00	52,00	10,00	A	NBR	17768	wheel hub	SCANIA	139 038		12010887	
110734	30,00	55,00	10,00	A	NBR	17780	crankshaft	IVECO	4587 996		12010889	
110724	30,00	55,00	10,00	A	NBR	17780	crankshaft	IVECO	724 579		12010889	
110725	30,00	55,00	10,00	A	NBR	17780	crankshaft	IVECO	734 128		12010889	
70452	30,00	55,00	10,00	A	NBR	17780	crankshaft	SCANIA	144 116		12010889	
70484	35,00	52,00	10,00	A	NBR	17934	gearbox	SCANIA	32 201	258407	12010899	
47576	35,00	47,00	7,00	A	NBR	17906	crankshaft	DB	005 997 5847	251402	12010904	
47664	35,00	52,00	10,00	A	NBR	17934	crankshaft	DB	009 997 5147	258407	12010908	
82323	35,00	58,00	10,00	A	NBR	17960	crankshaft	SCANIA	132 672		12010911	
109163	38,00	50,00	7,00	A	NBR	70214	crankshaft	DAF	3104 047		12010923	
114575	38,00	50,00	7,00	A	NBR	70214	crankshaft	DB	009 997 3146		12010923	
114574	38,00	50,00	7,00	A	NBR	70214	crankshaft	IVECO	4000 1820		12010923	
69284	38,00	50,00	7,00	A	NBR	70214	crankshaft	SCANIA	123 102		12010923	
47631	38,00	55,00	7,00	A	NBR	19536	transfer gearbox	DB	007 997 7847		12010926	
80020	38,00	55,00	7,00	A	FPM	41958	transfer gearbox	DB	007 997 8247		12010926	
82925	40,00	55,00	7,00	B	NBR	18076	crankshaft	MAN	06 56271 0404		12010932	
47013	40,00	62,00	10,00	A	NBR	18107	automatic gearbox	DB	005 997 1146	330809	12010936	
36988	40,00	62,00	10,00	A	NBR	18107	automatic gearbox	DB	008 997 9246	330809	12010936	81-21001-20
114583	40,00	62,00	10,00	A	NBR	18107	automatic gearbox	OPEL	744 500	330809	12010936	
46969	42,00	56,00	7,00	AS W	NBR	94735	water pump	DB	003 997 5146	344400	12010943	81-51109-00
47560	42,00	56,00	7,00	AS	NBR	94735	water pump	DB	005 997 0047	344400	12010943	
46955	42,00	60,00	10,00	A	NBR	18168	crankshaft	DB	003 997 1646	040320	12010944	
114585	42,00	62,00	10,00	A	NBR	18175	wheel hub	MAN	06 56279 0035	040355	12010946	
68810	45,00	60,00	7,00	A	NBR	70213	crankshaft	SCANIA	120 828	040606	12010950	
3896	45,00	60,00	10,00	A	NBR	18215	wheel hub	PEUGEOT	3724 18	048410	12010951	
47755	45,00	62,00	10,00	A	NBR	18223	crankshaft	DB	304 997 1347	367206	12010954	
114595	45,00	62,00	10,00	A	NBR	18223	crankshaft	MAN	06 56279 0039	367206	12010954	
4142	45,00	62,00	10,00	A	NBR	18223	crankshaft	PEUGEOT	3345 10		12010954	
114596	45,00	65,00	8,00	A	NBR	18232	crankshaft	SCANIA	244 249		12010955	
48452	50,00	65,00	8,00	A	NBR	97943	wheel hub	VW	211 405 641 D	412104	12010966	
84539	50,00	68,00	8,00	A	NBR	84538	crankshaft	SCANIA	214 005		12010967	
70451	50,00	70,00	10,00	A	NBR	18328	crankshaft	SCANIA	14 107		12010969	
47437	50,00	72,00	10,00	A	NBR	18335	crankshaft	DB	000 997 2247	418501	12010971	
47034	50,00	72,00	10,00	A	NBR	18335	crankshaft	DB	005 997 8546	418501	12010971	

dph-no	dim 1	dim 2	dim 3	Style	Material	dph oil seal no.	Application	Type	OEM-NO	Elring	Corteco	Reinz
113940	53,00	68,00	10,00	A	NBR	18390	crankshaft	RVI	5000 350 272		12010980	
47428	55,00	70,00	8,00	A	NBR	18407	wheel hub	DB	608 997 1346	440302	12010981	
47011	55,00	80,00	10/12	AS	NBR	80530	crankshaft	DB	005 997 0946	048437	12010986	
47836	58,00	72,00	8,00	A W	NBR	113615	crankshaft	DB	00650 405 8200		12010993	
113937	58,00	80,00	10,00	A	NBR	18473	wheel hub	RVI	5516 015 596		12010995	
117398	60,00	75,00	8,00	A	NBR	18484	crankshaft	IVECO	4459 074		12010997	
47745	60,00	80,00	10,00	A	NBR	81629	crankshaft	DB	303 997 0947	041491	12010999	
47325	60,00	65,00	10/8	A	NBR	48049	crankshaft	DB	009 997 1646		12011000	
47752	60,00	85,00	10,00	AS green	NBR	82395		DB	304 997 0947		12011000	
47746	60,00	90,00	10,00	A	NBR	18510	crankshaft	DB	303 997 1047	479004	12011002	
47519	65,00	85,00	10,00	A	NBR	18565	crankshaft	DB	003 997 3347	494402	12011007	
47529	65,00	85,00	10,00	A	NBR	18565	crankshaft	DB	003 997 6947	494402	12011007	
46898	68,00	90,00	10,00	A	NBR	4546	crankshaft	DB	001 997 1846	251720	12011012	
113942	68,00	90,00	10,00	A	NBR	4546	crankshaft	RVI	0024 411 680	251720	12011012	
47520	70,00	90,00	10,00	AS	NBR	18611	crankshaft	DB	003 997 3447		12011015	
47528	70,00	90,00	10,00	AS	NBR	18611	crankshaft	DB	003 997 6847		12011015	
47751	70,00	90,00	10,00	AS	NBR	18611	crankshaft	DB	304 997 0847		12011015	
114492	70,00	90,00	12/8	AS	NBR	114432	gearbox	RVI	5000 132 770		12011015	
114733	70,00	90,00	10,00	AS	NBR	18611	gearbox	VOLVO	6 876 132-9		12011015	
117399	70,00	100,00	12,00	A	NBR	84533	crankshaft	IVECO	3851 4100	325473	12011017	
110727	70,00	100,00	12,00	A	NBR	84533	engine various	IVECO	851 101	325473	12011017	
70486	70,00	100,00	12,00	A	NBR	84533	crankshaft	SCANIA	33 326	325473	12011017	
82349	72,00	100,00	10,00	A	NBR	18646	crankshaft	DAF	0325 321		12011019	
35697	75,00	95,00	10,00	A blue	NBR	6638	crankshaft	DB	000 997 5646	528102	12011020	
47539	75,00	100,00	10,00	A	NBR	84535	gearbox	DB	004 997 1347	530107	12011021	
114752	75,00	100,00	10,00	A	NBR	84535	wheel hub	IVECO	3851 0549	530107	12011021	
110726	75,00	100,00	10,00	A	NBR	84535	gearbox	IVECO	843 075		12011021	
3888	75,00	100,00	10,00	A blue	NBR	84535	gearbox	SCANIA	33 352	530107	12011021	
4049	80,00	100,00	10,00	A green	NBR	4306	front-/rear axle	DB	004 997 9646	546038	12011026	
47012	80,00	100,00	10,00	A green	NBR	4306	front-/rear axle	DB	005 997 1046	546038	12011026	
47273	80,00	100,00	10,00	A green	NBR	4306	front-/rear axle	DB	007 997 8346		12011026	
110739	80,00	100,00	10,00	A green	NBR	4306	front-/rear axle	IVECO	3850 5699	546038	12011026	
70446	80,00	100,00	10,00	A green	NBR	4306	front-/rear axle	SCANIA	120 979	546038	12011026	
34435	80,00	110,00	10,00	A	NBR	18694	crankshaft	SCANIA	304 552		12011029	
117416	80,00	110,00	12,00	A	NBR	18698	crankshaft	IVECO	3851 2262		12011030	

dph-no	dim 1	dim 2	dim 3	Style	Material	dph oil seal no.	Application	Type	OEM-NO	Elring	Corteco	Reinz
117402	80,00	110,00	13,00	A	NBR	18701	gearbox	IVECO	540 727		12011031	
119068	90,00	110,00	12,00	A	NBR	50350		RVI	50 0000 0813		12011043	
47485	95,00	120,00	12,00	A	NBR	18798	crankshaft	DB	002 997 0747		12011047	
80059	105,00	130,00	12,00	AS	NBR	97860	gearbox	MAN	81 96502 0349	282200	12011062	
82327	105,00	130,00	12,00	A	NBR	18844	crankshaft	ZF	0750 110 001		12011062	
34423	117,47	142,87	12,70	A blue	NBR	84532	crankshaft	SCANIA	173 320	325511	12011073	
47758	150,00	180,00	13,00	AS	NBR	6713	front & rear axle	DB	317 997 0047		12011091	
110738	150,00	180,00	13	A	NBR	6713	front-/rear axle	IVECO	852 7970	109657	12011091	
34422	150,81	177,80	12,70	AS blue	NBR	84589	wheel hub	SCANIA	159 496	325503	12011092	
4500	165,00	190,00	13,00	A blue	NBR	4374	crankshaft	DB	304 997 0447	675407	12011096	
35131	165,00	190,00	13,00	A blue	NBR	4374	fron-/rear axle	MAN	06 56289 0013		12011096	
47309	185,00	210,00	13,00	A	NBR	6369	rear axle	DB	009 997 0046	563617	12011099	81-35117-00
47348	185,00	210,00	13,00	A	NBR	6369	rear axle	DB	010 997 0046	563617	12011099	81-35117-00
6477	185,00	210,00	13,00	A blue	NBR	6369	rear axle	DB	304 997 1747	563617	12011099	
114521	17,00	28,00	7,00	AS	NBR	17448	crankshaft	DAF	0119 468	050300	12011112	
46889	17,00	28,00	7,00	AS	NBR	17448	crankshaft	DB	000 997 6546		12011112	
112551	17,00	28,00	7,00	AS	NBR	17448	crankshaft	IVECO	128 8064		12011112	
95850	17,00	28,00	7,00	AS	NBR	17448	differential	SCANIA	210 648		12011112	
46895	20,00	40,00	7/8	AS	NBR	47959	crankshaft	DB	000 997 9946		12011118	
47009	20,00	40,00	7/8	AS	NBR	47959	crankshaft	DB	004 997 9946		12011118	
114525	20,00	40,00	7/8	AS	NBR	47959	crankshaft	SCANIA	210 743		12011118	
47347	25,00	35,00	7,00	AS	NBR	84590	injection pump	DB	009 997 9746	038075	12011122	
47395	25,00	35,00	7,00	AS	NBR	84590	injection pump	DB	011 997 4746	038075	12011122	
70465	25,00	35,00	7,00	AS	NBR	84590	injection pump	SCANIA	192 600	038075	12011122	
119405	25,00	35,00	7,00	AS	NBR	84590	injection pump	VOLVO	192 600		12011122	
81848	25,00	35,00	7,00	AS	NBR	84590	injection pump	VOLVO	240 022	038075	12011122	
117395	25,00	40,00	7,00	AS	NBR	17615	crankshaft	IVECO	298 2310		12011123	
117394	25,00	40,00	7,00	AS	NBR	17615	steering	IVECO	767 775	038164	12011123	
46998	30,00	40,00	7,00	AS	NBR	17725	crankshaft	DB	004 997 6246	038806	12011131	
82551	30,00	40,00	7,00	AS RD W	FPM	47982	camshaft	DB	018 997 7947	598993	12011131	81-15512-50
117396	35,00	47,00	7,00	AS	NBR	17907	crankshaft	IVECO	126 8104		12011143	
4058	36,51	52,58	7,93	AS	NBR	45544	wheel hub	FORD	1 572 045		12011150	
4060	40,00	52/58,00	7,5/6	AS WD W	NBR	37227	rear axle	VW	321 501 641	045772	12011153	
35480	38,00	52/58,00	8,50	AS BD	NBR	37098	front axle	VW	311 405 641 B		12011154	
51456	40,00	52/62,00	8,50	AW SP	NBR	51455	front & rear axle	OPEL	328 410		12011155	

dph-no	dim 1	dim 2	dim 3	Style	Material	dph oil seal no.	Application	Type	OEM-NO	Elring	Corteco	Reinz
4061	40,00	52/62,00	8,50	AW SP	NBR	51455	front & rear axle	OPEL	328 637	043923	12011155	81-31435-00
46934	40,00	55,00	8,00	B	NBR	18079	gearbox	DB	002 997 2546		12011157	
47727	40,00	55,00	8,00	AS	NBR	18078	wheel hub	DB	012 997 3847	039993	12011157	
112359	40,00	55,00	8,00	AS	NBR	18078	wheel hub	FORD	1 101 837		12011157	
4062	40,00	55,00	8,00	AS	NBR	18078	wheel hub	FORD	1 482 324	039993	12011157	
33296	40,00	55,00	8,00	AS	NBR	18078	wheel hub	FORD	1 579 665	039993	12011157	
50868	44,50	62,00	10/7	AS2 WD	NBR	95590	rear axle	VW	113 501 315 H	042803	12011164	
117397	45,00	65,00	10,00	AS	NBR	18234	crankshaft	IVECO	3 345 907		12011168	
112360	50,00	65,00	9,75/14	BS SP	NBR	112367	wheel hub	FORD	1 637 281		12011175	
112361	55,00	70,00	6/10,5	BS SP	NBR	112368	wheel hub	FORD	1 637 280	587036	12011181	
4073	55,00	70,00	6/10,25	BS SP	NBR	112368	rear axle	FORD	6 043 882	587036	12011181	
109142	55,00	70,00	8,00	AS	NBR	50342	wheel hub	ALFA	60709430		12011182	
47704	65,00	85,00	10,00	AS	NBR	18566	crankshaft	DB	011 997 1247		12011195	
47496	65,00	90,00	10,00	AS WD	NBR	48006	crankshaft	DB	002 997 4147		12011196	
118373	100,00	120,00	12,00	AS	NBR	19863	crankshaft	DAF	1 602 361		12011209	
82324	100,00	120,00	12,00	AS	NBR	19863	wheel accessory kit	VOLVO	968 012-5		12011209	
114647	130,00	160,00	15,00	AS	NBR	19889	crankshaft	MAN	06 56289 0244		12011213	
47759	150,00	180,00	14,00	AS	NBR	44260	crankshaft	DB	335 997 0047		12011215	
3898	42,00	62,00	10,00	A	NBR	18175	wheel hub	PEUGEOT	3724 08	040355	12011236	
47591	45,00	67,00	12/13,00	BS RD LA	FPM	36211	crankshaft	DB	006 997 1247	305529	12011247	81-21023-30
97150	42,00	56/63,00	7,20	B RD	ACM	112611	crankshaft	FIAT	4000 0320	440770	12011279	
82770	35,80	68,00	10,00	BS RD	ACM	82769	differential	FIAT	4000 2190		12011293	
119099	90,00	115,00	13,00	A/BS LD W	FPM	81347	crankshaft	IVECO	4010 0310		12011304	
81570	90,00	115,00	13,00	A/BS LD W	FPM	81347	crankshaft	IVECO	4010 0313		12011304	
111783	23,00	35,00	7,00	A/BS RD	FPM	111782	crankshaft	FIAT	4000 4200	440710	12011305	81-35719-00
111584	48,00	69,00	10,00	B RD	FPM	47988	gearbox	DAF	0693 402		12011306	81-35078-00
47614	48,00	69,00	10,00	B RD	FPM	47988	gearbox	DB	007 997 2047		12011306	81-35078-00
69158	48,00	69,00	10,00	B RD	FPM	47988	gearbox	MAN	81 96502 0226		12011306	
95881	48,00	69,00	10,00	B RD	FPM	47988	gearbox	VOLVO	6 876 126-1		12011306	81-35078-00
82326	48,00	69,00	10,00	B RD	FPM	47988	gearbox	ZF	0734 310 108		12011306	
84618	48,00	75,00	8,00	B RD	FPM	4545	gearbox	DAF	0110 466	033472	12011307	
114671	48,00	75,00	8,00	B RD	FPM	4545	gearbox	DAF	0609 458	033472	12011307	
47537	48,00	75,00	8,00	B RD	FPM	4545	gearbox	DB	004 997 0747	033472	12011307	
4441	48,00	75,00	8,00	B RD brown	FPM	4545	gearbox	DB	007 997 5447	033472	12011307	
47651	48,00	75,00	8,00	B RD	FPM	4545	gearbox	DB	008 997 3847	033472	12011307	

dph-no	dim 1	dim 2	dim 3	Style	Material	dph oil seal no.	Application	Type	OEM-NO	Elring	Corteco	Reinz
114672	48,00	75,00	8,00	B RD	FPM	4545	gearbox	MAN	06 56279 0084	033472	12011307	
93757	48,00	75,00	8,00	B RD	FPM	4545	gearbox	MAN	81 96502 0225	033472	12011307	
97374	48,00	75,00	8,00	B RD	FPM	4545	gearbox	ZF	0734 310 110		12011307	
82329	48,00	75,00	8,00	B RD	FPM	4545	gearbox	ZF	0750 111 002		12011307	
95340	55,00	75,00	8,00	B RD	FPM	36792	gearbox	DB	004 997 6946		12011308	
36793	55,00	75,00	8,00	B RD	FPM	36792	gearbox	DB	007 997 2247	284645	12011308	
93804	55,00	75,00	8,00	B RD	FPM	36792	gearbox	MAN	81 96502 0761	284645	12011308	
95877	55,00	75,00	8,00	B RD	FPM	36792	gearbox	ZF	0734 310 111		12011308	
113768	55,00	75,00	8,00	B RD	FPM	36792	gearbox	ZF	0734 310 386		12011308	
114612	95,00	120,00	13,00	BS LD	FPM	82399	crankshaft	IVECO	4000 0720	071570	12011314	
112552	114,00	135,00	13,00	AW BS LD	FPM	116149	crankshaft	IVECO	4000 3800		12011318	
95892	150,00	180,00	17,5/16	BS2 WD	FPM	95891	crankshaft	VOLVO	1 522 896	590738	12011324	
95056	180,00	200,00	12,00	A/B W WD	FPM	81338	rear axle	IVECO	4000 3730	018670	12011326	
113032	180,00	200,00	12,00	B WD	FPM	113031	crankshaft	IVECO	4203 7582	018670	12011326	
4502	26,00	45,00	10,00	B blue	NBR	4442	injection	DB	003 997 4046	038490	12011330	81-20308-00
109165	48,00	65,00	10,00	B	NBR	81637	gearbox	DAF	0586 697	040991	12011331	
47615	48,00	65,00	10,00	B	NBR	81637	gearbox	DB	007 997 2147	040991	12011331	
109062	48,00	65,00	10,00	B	NBR	81637	gearbox	FORD	6 109 963		12011331	
110729	48,00	65,00	10,00	B	NBR	81637	gearbox	IVECO	127 4257		12011331	
110731	48,00	65,00	10,00	B	NBR	81637	gearbox	IVECO	298 0071		12011331	
111640	48,00	65,00	10,00	B	NBR	81637	gearbox	IVECO	4248 7485		12011331	
35115	48,00	65,00	10,00	B green	NBR	81637	gearbox	MAN	06 56279 0042	040991	12011331	
34634	48,00	65,00	10,00	B green	NBR	81637	gearbox	MAN	81 96502 0248	040991	12011331	
114606	48,00	65,00	10,00	B	NBR	81637	gearbox	RENAULT	77 01 014 157	040991	12011331	
114607	48,00	65,00	10,00	B	NBR	81637	gearbox	VOLVO	6 857 279-1	040991	12011331	
108799	48,00	65,00	10,00	B	NBR	81637	gearbox	VOLVO	6 876 127-9	040991	12011331	
109257	48,00	65,00	10,00	B	NBR	81637	gearbox	ZF	0734 300 087		12011331	
46986	55,00	75,00	10/8	B	NBR	50345	gearbox	DB	004 997 0946	041335	12011333	81-20991-20
109256	55,00	75,00	10/8	B	NBR	50345	gearbox	ZF	0734 300 094		12011333	
82211	60,00	85,00	10,00	B	NBR	47466	differential	DB	002 997 7646	041599	12011334	
47622	60,00	85,00	10,00	B	NBR	47466	gearbox	DB	007 997 5547		12011334	
112548	60,00	85,00	10,00	B	NBR	47466	gearbox	IVECO	4000 2020		12011334	
35098	60,00	85,00	10,00	B	NBR	47466	gearbox	MAN	06 56272 1313		12011334	
94631	60,00	85,00	10,00	B	NBR	47466	gearbox	ZF	0734 300 100		12011334	
46983	85,00	105,00	10,00	B	NBR	50341	gearbox	DB	004 997 0646	556807	12011340	81-25546-00

dph-no	dim 1	dim 2	dim 3	Style	Material	dph oil seal no.	Application	Type	OEM-NO	Elring	Corteco	Reinz
35690	85,00	105,00	10,00	B blue	NBR	50341	gearbox	MAN	06 56289 0132	556807	12011340	
35210	85,00	105,00	10,00	B blue	NBR	50341	gearbox	MAN	81 96501 0446	556807	12011340	
111794	85,00	105,00	10,00	B	NBR	50341	gearbox	ZF	0634 300 712		12011340	
111581	85,00	105,00	12/10	B	NBR	95872	gearbox	DAF	0585 373	033480	12011341	81-35091-00
47719	85,00	105,00	12,00	B	NBR	44329	gearbox	DB	011 997 8547	033480	12011341	81-35091-00
95874	85,00	105,00	12/10	B	NBR	95872	gearbox	ZF	0734 300 093		12011341	
82328	85,00	105,00	12,00	B	NBR	44329	gearbox	ZF	0750 110 074		12011341	
114510	118,00	136,00	13,00	B	NBR	18895	crankshaft	IVECO	4000 1060		12011347	
47493	140,00	160,00	13,00	BS	NBR	70576	rear axle	DB	002 997 3247	255637	12011349	
117412	140,00	160,00	13,00	BS	NBR	70576	rear axle	IVECO	4560 719		12011349	
84394	140,00	160,00	13,00	BS	NBR	70576	rear axle	MAN	06 56289 0186	255637	12011349	
84619	17,00	28,00	7,00	B	NBR	37867		DAF	0110 732		12011351	
114770	85,00	105,00	13,00	BS	NBR	32425	gearbox	DAF	0578 507		12011359	
46984	85,00	105,00	12,00	B	NBR	44329		DB	004 997 0746		12011359	
47282	85,00	105,00	13,00	BS	NBR	32425	gearbox	DB	007 997 9946	096067	12011359	81-35092-00
6550	85,00	105,00	13,00	BS blue	NBR	32425	gearbox	DB	009 997 1146	096067	12011359	
35147	85,00	105,00	13,00	BS blue	NBR	32425	differential	MAN	06 56289 0033	096067	12011359	81-35092-00
68541	85,00	105,00	13,00	BS	NBR	32425	gearbox	MAN	06 56289 0167	096067	12011359	
114771	85,00	105,00	13,00	BS	NBR	32425	differential	ZF	0634 309 106		12011359	
93700	85,00	110,00	12,00	BS	NBR	42696	crankshaft	IVECO	247 7868		12011360	
117407	100,00	120,00	10,00	BS SF	NBR	111681	crankshaft	IVECO	4000 0760		12011363	
81414	125,00	150,00	13,00	BS	NBR	18911	wheel hub	VOLVO	946 093-2	108626	12011367	
111638	145,00	170,00	13,00	BS blue	NBR	18949	wheel hub	IVECO	4000 0480		12011373	
47527	145,00	175,00	14,00	BS	NBR	4376	rear axle	DB	003 997 6647	208210	12011374	
47376	145,00	175,00	14,00	BS	NBR	4376	rear axle	DB	011 997 0046	002313	12011374	81-91002-00
4440	145,00	175,00	14,00	BS green	NBR	4376	rear axle	DB	011 997 4446	002313	12011374	
34647	145,00	175,00	14,00	BS blue	NBR	4376	rear axle	MAN	06 56289 0027		12011374	
34818	145,00	175,00	14,00	BS	NBR	4376	rear axle	MAN	06 56289 0064		12011374	
84414	160,00	185,00	13,00	BS	NBR	18967	crankshaft	DB	010 997 4646		12011376	
114662	160,00	185,00	13,00	BS	NBR	18967	crankshaft	IVECO	4000 1650		12011376	
118921	160,00	185,00	13,00	BS	NBR	18967	crankshaft	IVECO	4000 1653		12011376	
110732	160,00	185,00	13,00	BS	NBR	18967	crankshaft	IVECO	4580 400		12011376	
95055	180,00	200,00	12,00	BS	NBR	82893	crankshaft	IVECO	4000 3720	348376	12011378	
98440	180,00	200,00	12,00	BS	NBR	82893	crankshaft	IVECO	4203 7581	348376	12011378	
111639	180,00	200,00	15,00	BS green	NBR	70805	crankshaft	IVECO	4000 0690		12011379	

dph-no	dim 1	dim 2	dim 3	Style	Material	dph oil seal no.	Application	Type	OEM-NO	Elring	Corteco	Reinz
94369	180,00	200,00	15,00	CS	NBR	70806	crankshaft	SAF	4 373 0006 00		12011379	
114693	55,00	68,00	12,00	B Duo	NBR	93695	crankshaft	IVECO	247 8478		12011383	
3908	50,00	64,00	10/13,00	B	NBR	37519	rear axle	DB	001 997 4746	411701	12011385	
114650	133,35	155,60	14,00	B WD	NBR	36376	wheel hub	VOLVO	1 577 624		12011387	
36375	133,30	155,60	14,00	B WD	NBR	36376	wheel hub	VOLVO	944 667-5	522856	12011387	81-35111-00
34427	145,00	170,00	15/20	B SP	NBR	50174	rear axle	SCANIA	291 076	586838	12011388	
50177	145,00	170,00	15/20	B SP	NBR	50174	crankshaft	SCANIA	370 076	586838	12011388	
80881	148,00	168/170,00	32,00	B WD F	NBR	80880	rear axle	VOLVO	944 665-9	522864	12011389	81-35113-00
46951	90,00	112,70	13,00	C	NBR	50803	rear axle	DB	002 997 6846	044571	12011397	81-33850-00
94988	90,00	112,70	13,00	C	NBR	50803	rear axle	DB	003 997 6846		12011397	
47241	95,00	120,00	13,00	C	NBR	51723	rear axle	DB	006 997 6946	042684	12011398	81-35093-00
114613	95,00	120,00	13,00	C	NBR	51723	rear axle	MAN	06 56289 0111	042684	12011398	81-35093-00
114614	95,00	120,00	13,00	C	NBR	51723	rear axle	MAN	06 56289 0273		12011398	
46876	95,00	125,00	13,00	CS	NBR	82785	front axle	DB	000 997 3446	042714	12011399	
47521	95,00	130,00	13,00	C	NBR	18810	front axle	DB	003 997 4047	042714	12011399	
47260	100,00	120,00	13,00	C	NBR	18825	front axle	DB	007 997 3646	592609	12011400	81-35097-00
47716	100,00	120,00	13,00	C	NBR	18825	front axle	DB	011 997 7147	562609	12011400	
47247	100,00	125,00	13,00	C	NBR	18829	rear axle	DB	006 997 9346		12011401	81-35096-00
114621	100,00	125,00	13/10	C	NBR	50810	rear axle	MAN	06 56289 0009		12011401	81-35096-00
35021	105,00	130,00	13,00	C	NBR	18846	front axle	DB	000 997 6447	042846	12011403	81-35098-00
46965	105,00	130,00	13,00	C	NBR	18846	front axle	DB	003 997 4546		12011403	
114629	105,00	130,00	13,00	C	NBR	18846	front axle	MAN	06 56289 0113	042846	12011403	81-35098-00
35022	110,00	140,00	13,00	C blue	NBR	50802	rear axle	DB	000 997 7446	612103	12011404	
47301	110,00	140,00	13,00	C	NBR	50802	rear axle	DB	008 997 6246	612103	12011404	
47038	120,00	145,00	15,00	C	NBR	43207	rear axle	DB	006 997 0546	044679	12011405	81-35106-00
46879	125,00	152,40	15,00	CS	NBR	94589	rear axle	DB	000 997 4046	044687	12011406	81-35107-00
47471	125,00	152,40	15,00	CS	NBR	94589	rear axle	DB	001 997 3847	044687	12011406	81-35107-00
33377	125,00	152,40	15,00	CS	NBR	94589	rear axle	DB	002 997 4046	044687	12011406	
4375	145,00	175,00	13,00	A/B W blue	NBR	82427	rear axle	DB	011 997 4346		12011407	
35156	145,00	175,00	13,00	A/B W blue	NBR	82427	rear axle	MAN	06 56289 0063		12011407	
34819	145,00	175,00	13,00	A/B W blue	NBR	82427	rear axle	MAN	06 56289 0065		12011407	
117413	145,00	175,00	13,00	C	NBR	6729	rear axle	RVI	5000 281 014		12011407	
35102	70,00	90,00	12,00	C	NBR	18616	wheel hub	MAN	06 56272 1814		12011410	
46852	75,00	100,00	13,00	CS	NBR	97437	wheel hub	DB	000 997 1446	105414	12011411	
117400	75,00	100,00	13,00	CS	NBR	97437	gearbox	IVECO	4000 1830		12011411	

dph-no	dim 1	dim 2	dim 3	Style	Material	dph oil seal no.	Application	Type	OEM-NO	Eling	Corteco	Reinz
83897	75,00	100,00	13,00	CS	NBR	97437	gearbox	IVECO	4000 1880		12011411	
114754	75,00	100,00	13,00	CS	NBR	97437	gearbox	IVECO	883 6666		12011411	
111642	90,00	110,00	13,00	CS	NBR	18763	rear axle	IVECO	4000 1900		12011412	
34671	90,00	120,00	13,00	C green	NBR	51722	rear axle	DB	006 997 0446	042617	12011413	81-35149-00
117409	100,00	130,00	13,00	CS	NBR	81335	wheel hub	IVECO	4000 1910		12011415	
82366	100,00	130,00	13,00	CS	NBR	81335	wheel hub	IVECO	4000 1913		12011415	
114483	105,00	136,00	13,00	CS	NBR	114427	wheel hub	IVECO	4000 2851		12011416	
114636	117,47	142,87	12,70	CS	NBR	81339	wheel hub	IVECO	4000 1010		12011417	
81569	117,47	142,87	12,70	CS	NBR	81339	wheel hub	IVECO	4000 1920		12011417	
47541	120,00	150,00	15/12	CS	NBR	48002	front axle	DB	004 997 1747	010901	12011418	81-35103-00
47542	120,00	150,00	15/12	CS	NBR	48002	front axle	DB	004 997 1847	010901	12011418	81-35103-00
93379	120,00	150,00	15/12	CS	NBR	48002	front axle	DB	009 997 9046		12011418	
117411	125,00	150,00	13,00	CS	NBR	81334	crankshaft	IVECO	4000 1930		12011419	
84199	125,00	150,00	13,00	CS	NBR	81334	crankshaft	IVECO	4000 1933	022560	12011419	
114643	125,00	150,00	13,00	CS	NBR	81334	crankshaft	MAN	06 56289 0038	635600	12011419	
93558	125,00	150,00	13,00	CS	NBR	81334	crankshaft	SAF	4 373 0008 00		12011419	
111635	150,00	170,00	15,00	CS	NBR	61249	crankshaft	IVECO	244 2744		12011423	
114657	150,00	170,00	15,00	CS	NBR	61249	crankshaft	MAN	06 56289 0115		12011423	
114658	150,00	170,00	15,00	CS	NBR	61249	crankshaft	SAF	4 373 0014 00		12011423	
119284	17,00	28,00	7,00	B RD	ACM	118614	gearbox	Fiat	4000 0090		12011426	
119285	17,00	28,00	7,00	B RD	ACM	118614	gearbox	Fiat	4000 1460		12011426	
119286	17,00	28,00	7,00	B RD	ACM	118614	gearbox	RENAULT	77 00 522 671		12011426	
119287	17,00	28,00	7,00	B RD	ACM	118614	gearbox	RENAULT	77 03 087 085		12011426	
119098	50,00	81,00	13,00	BS	ACM	81345	differential	IVECO	4000 3710		12011432	
83899	50,00	81,00	13,00	BS	ACM	81345	differential	IVECO	4000 3713		12011432	
119097	62,00	80,00	10,00	BS LD	ACM	81351	crankshaft	IVECO	4000 0280		12011433	
83894	62,00	80,00	10,00	BS LD	ACM	81351	crankshaft	IVECO	4000 0283	028436	12011433	
97151	64,00	80,00	8,00	B RD	ACM	94587	crankshaft	FIAT	4000 0460		12011436	
48473	70,00	90,00	10,00	BS LD	MVQ	48472	crankshaft	LADA	2101 100 5160		12011438	81-15287-10
97153	40,00	56,00	7,00	B RD	ACM	48470	crankshaft	FIAT	4000 0050	325007	12011455	
112546	40,00	56,00	7,00	B RD	ACM	48470	crankshaft	IVECO	4000 0050	325007	12011455	
48471	40,00	56,00	7,00	B RD	ACM	48470	crankshaft	LADA	2101 100 5034		12011455	81-21087-10
83895	42,00	62,00	10,00	B RD	ACM	81352	crankshaft	IVECO	4000 0583		12011459	
114588	42,00	65,00	12/8	AW/BS RD	ACM	82398	crankshaft	IVECO	4000 0010		12011460	
97931	62,00	80,00	12,00	BS RD LA	FPM	97930		FORD	6 135 100	562629	12011475	81-23418-10

dph-no	dim 1	dim 2	dim 3	Style	Material	dph oil seal no.	Application	Type	OEM-NO	Eling	Corteco	Reinz
46906	20,00	35,00	6,00	A	NBR	17511	crankshaft	DB	001 997 6846		12011484	
15266	38,00	52,00	10,00	B	NBR	51486	gearbox	DB	008 997 3346	039780	12011499	
114600	45,00	65,00	10,00	B	NBR	51487	gearbox	MAN	06 56279 0003	040843	12011509	
61355	18,00	30,00	7/8	AS	NBR	4536	crankshaft	DB	009 997 5247		12011517	
47353	70,00	90,00	10,00	B	NBR	18612	crankshaft	DB	010 997 2446	246891	12011533	
47368	70,00	90,00	10,00	B	NBR	18612	crankshaft	DB	010 997 6046	246891	12011533	
47701	70,00	90,00	10,00	B	NBR	18612	gearbox	DB	010 997 9647	246891	12011533	
97152	30,00	52,00	7,00	A/B RD	ACM	111768	crankshaft	FIAT	4000 0470	212458	12011539	
4064	44,70	54,00	5,5/9,1	B SP	NBR	82154	wheel hub	RENAULT	77 03 087 071		12011541	
3901	35,00	50,00	8,00	A RD	ACM	3900	crankshaft	PEUGEOT	0514 15	293946	12011547	81-21798-30
114507	140,00	160,00	14,00	C WD	ACM	114452	crankshaft	IVECO	4010 0103		12011593	
97054	22,00	35,00	7,00	A/BS LD	FPM	118613	crankshaft	DEUTZ	117 2559		12011664	
119558	22,00	35,00	7,00	A/BS LD	FPM	118613	camshaft	Fiat	4000 4380		12011664	
47544	75,00	100,00	12/13,00	BS RD F	FPM	36208	crankshaft	DB	004 997 3947	525316	12011674	
46997	75,00	100,00	12/13,00	BS RD	FPM	36208	crankshaft	DB	004 997 6046	525316	12011674	
47585	75,00	100,00	12/13,00	BS RD F	FPM	36208	crankshaft	DB	005 997 8247	525316	12011674	
47713	75,00	100,00	12/13,00	BS RD F	FPM	36208	crankshaft	DB	011 997 5647	525316	12011674	
36221	75,00	100,00	12/13,00	BS RD	FPM	36208	crankshaft	DB	011 997 5747	525316	12011674	81-20309-20
47400	75,00	100,00	12/13,00	BS RD F	FPM	36208	crankshaft	DB	011 997 7046	525316	12011674	
34421	80,00	100,00	12,00	BS RD LA	FPM	34420	crankshaft	SCANIA	338 643	527823	12011821	81-25013-20
51728	30,00	42,00	7,00	AS RD	FPM	51727	manual transmission	BMW	23 11 1 228 314		12011839	
110810	30,00	42,00	7,00	AS RD	FPM	51727	manual transmission	RENAULT	77 00 749 395	505838	12011839	81-17539-50
70480	155,00	180,00	24/29	B SP	FPM	50175	wheel hub	SCANIA	291 463	598925	12011917	
50176	155,00	180,00	24/29	B SP	FPM	50175	wheel hub	SCANIA	370 075	598925	12011917	
70483	45,00	65,00	9,00	BS RD LA	ACM	81126	gearbox	SCANIA	314 063	325562	12011970	
37517	45,00	64,00	12/7	SP WD	NBR	48029	front axle	DB	011 997 5147	578134	12012039	81-35076-00
84170	48,00	65,00	10,00	AW/BS RD F	FPM	36203	crankshaft	BMW	11 14 1 265 431	022918	12012045	
36212	48,00	65,00	10,00	AW/BS RD F	FPM	36203	crankshaft	BMW	11 14 1 274 346	586676	12012045	81-17404-50
61330	48,00	65,00	9,00	AW/BS RD	FPM	61331	crankshaft	BMW	11 14 1 275 466	586676	12012045	
114668	48,00	65,00	10,00	AW/BS RD	FPM	36203	crankshaft	VOLVO PC	6 797 454-3		12012045	
111643	180,00	200,00	12,00	BS	NBR	82893	crankshaft	IVECO	4010 0440		12012049	
109745	180,00	200,00	12,00	BS	NBR	82893	crankshaft	IVECO	4010 0443		12012049	
94513	120,00	140,00	13,00	BS	NBR	94932	crankshaft	IVECO	247 5845	105457	12012064	
109678	120,00	140,00	13,00	C	NBR	94015	crankshaft	SAF	4 373 0003 00	042935	12012064	
114637	120,00	140,00	13,00	CS	NBR	51716	front & rear axle	VOLVO	1 696 066		12012064	81-35104-00

dph-no	dim 1	dim 2	dim 3	Style	Material	dph oil seal no.	Application	Type	OEM-NO	Elring	Corteco	Reinz
111636	110,00	130,00	13,00	CS	NBR	111637	crankshaft	IVECO	247 5900		12012065	
35149	110,00	130,00	13,00	C	NBR	18863	rear axle	MAN	06 56289 0035		12012065	
46964	68,00	90,00	13,00	BS RD	FPM	47947		DB	003 997 4446	331171	12012074	81-35083-00
47637	68,00	90,00	13,00	BS RD	FPM	47947	differential	DB	008 997 0747	331171	12012074	81-35083-00
47638	68,00	90,00	13,00	BS RD	FPM	47947	differential	DB	008 997 0847	331171	12012074	81-35083-00
47412	68,00	90,00	13,00	BS RD	FPM	47947	differential	DB	011 997 9846	331171	12012074	81-35083-00
81566	65,00	85,00	13/12,5	BS RD LA SP	FPM	93422	crankshaft	DEUTZ	223 4133		12012095	
81014	65,00	85,00	13/12,5	BS RD LA SP	FPM	93422	crankshaft	DEUTZ	415 0782	033457	12012095	81-21527-20
94512	44,45	60,33	9,50	AS	NBR	94511	wheel hub	FORD	1 536 229		12012128	
4063	42,00	58,00	7,00	BS	NBR	37347	rear axle	BMW	33 41 3 404 161	040304	12012129	
50874	115,00	140,00	16,00	BS LA LD	FPM	48305	crankshaft	DEUTZ	223 4134	033376	12012148	
51674	115,00	140,00	16,00	BS LA LD	FPM	48305	crankshaft	DEUTZ	415 0783	033376	12012148	81-20481-20
119131	115,00	140,00	16,00	BS LA LD	FPM	48305	crankshaft	DEUTZ	415 2349	033376	12012148	
82331	115,00	140,00	16,00	BS LA LD	FPM	48305	crankshaft	DEUTZ	423 0392	033376	12012148	
98517	161,92	187,32	12,70	A	NBR	24964	reductor hub	SCANIA	309 113		12012234	
114616	95,30	114,29	11,88	BS WD LA	FPM	96979	gearbox	DAF	0696 084		12012235	
110730	95,30	114,29	11,88	BS WD LA	FPM	96979	crankshaft	IVECO	190 5085		12012235	
114617	95,30	114,29	11,88	BS WD LA	FPM	96979	gearbox	IVECO	4249 0447		12012235	
110735	95,30	114,29	11,88	BS WD LA	FPM	96979	gearbox	IVECO	798 0661		12012235	
114618	95,30	114,29	11,88	BS WD LA	FPM	96979	crankshaft	MAN	81 96502 0451		12012235	
117252	95,30	114,29	11,88	BS WD LA	FPM	96979	gearbox	RVI	5000 814 109		12012235	
70481	137,00	161,92	15/12	BS WD LA SP	NBR	61646	crankshaft	SCANIA	297 991	586803	12012241	
61647	137,00	161,92	15/12	BS WD LA SP	NBR	61646	rear axle	SCANIA	370 074		12012241	
47031	59,00	72,00	12/12,50	AW/BS	NBR	15259	transmission shaft	DB	005 997 7146	467871	12012242	81-35081-00
37518	59,00	72,00	12/12,50	AW/BS	NBR	15259	transmission shaft	DB	005 997 7846		12012242	
3909	59,00	72,00	12/12,50	AW/BS	NBR	15259	transmission shaft	DB	007 997 3547	467871	12012242	81-35081-00
15262	93,00	117,00	12,00	BS LD LA	FPM	6648	crankshaft	DB	008 997 2647	344230	12012246	81-25242-00
36224	93,00	117,00	12,00	BS LD LA	FPM	6648	crankshaft	DB	010 997 8247	344230	12012246	81-25242-00
47636	45,00	67/72,00	12/13	AS W RD	FPM	47996	crankshaft	DB	008 997 0447	284785	12012247	
37326	45,00	67/72,00	12/13	AS W RD	FPM	47996	crankshaft	DB	008 997 0547	284785	12012247	
47654	45,00	67,00	12/13,00	BS RD LA	FPM	36211	crankshaft	DB	008 997 5247	305529	12012247	81-21023-30
36666	45,00	67,00	8,00	AS W RD	FPM	36206	crankshaft	DB	010 997 0947		12012248	
36227	45,00	67,00	8,00	ASW RD	FPM	36206	crankshaft	DB	010 997 3347		12012248	
48712	45,00	67,00	8,00	ASW RD	FPM	36206	crankshaft	DB	120 997 0346	914924	12012248	81-26248-00
36226	93,00	114,00	14,00	AS W LD	FPM	48028	crankshaft	DB	010 997 9047		12012249	

dph-no	dim 1	dim 2	dim 3	Style	Material	dph oil seal no.	Application	Type	OEM-NO	Elring	Corteco	Reinz
15255	45,00	60,00	9/7	AS RD	ACM	36895	crankshaft	OPEL	638 187	590762	12012250	81-19195-00
80039	45,00	60,00	9/7	AS RD	ACM	36895	crankshaft	OPEL	638 193	590762	12012250	
114593	45,00	60,00	9/7	AS RD	ACM	36895	crankshaft	RENAULT	77 03 087 079		12012250	
59263	85,00	105,00	12,00	AS W LD	FPM/ACM	114899	crankshaft	PEUGEOT	0514 40	315494	12012347	
4277	85,00	105,00	12,00	A/BS LD W	FPM	61492	crankshaft	VOLVO PC	1 257 049	342092	12012347	
61492	85,00	105,00	12,00	A/BS LD W	FPM	61492	crankshaft	VOLVO PC	3 287 542	342092	12012347	81-36788-00
22982	85,00	105,00	12,00	A/BS LD W	FPM	61492	crankshaft	VW	056 103 051 D		12012347	
111769	30,00	52,00	7,00	A/B RD	ACM	111768	crankshaft	FIAT	4000 4460	212458	12012411	
36216	125,00	160,00	18,00	BS LD F	FPM	36207	crankshaft	DB	004 997 9347	316385	12012432	81-21040-10
47335	125,00	160,00	18,00	BS LD F	FPM	36207	crankshaft	DB	009 997 5146	316385	12012432	
36790	85,00	105,00	13,00	B WD	FPM	36789	rear axle	DB	010 997 3646	008680	12012549	81-35089-00
47363	85,00	105,00	13,00	B WD	FPM	36789	rear axle	DB	010 997 5446	008680	12012549	
68551	85,00	105,00	13,00	B WD	FPM	36789	rear axle	MAN	06 56289 0048	008680	12012549	81-35089-00
97903	69,60	99,97	20,7/12,7	AS WD SF	NBR	97902	wheel hub	FORD	6 143 629		12012569	
48722	54,51	76,09	9,5/15,4	AS RD SF	NBR	97926	wheel hub	FORD	6 142 760		12012570	
47331	72,00	105,00	13,00	BS	NBR	4767	front & rear axle	DB	009 997 4546	008559	12012573	
47344	72,00	105,00	13,00	BS	NBR	4767	front&rear axle	DB	009 997 9146	008559	12012573	
47715	72,00	105,00	13,00	BS	NBR	4767	front&rear axle	DB	011 997 7047	008559	12012573	
35110	72,00	105,00	13,00	BS green	NBR	4767	front&rear axle	MAN	06 56279 0028	008559	12012573	
69160	72,00	105,00	13,00	BS	NBR	4767	front&rear axle	MAN	06 56279 0312	008559	12012573	
48358	28,00	40,00	8/6,00	AS SP	NBR	36704	steering	DB	011 997 7246	237744	12012574	
93350	68,00	90,00	10/9,50	B WD	FPM	47989	differential	MAN	06 56279 0323		12012575	
4615	170,00	190,00	8,50	AS K	NBR	4045	rear axle	DB	005 997 8447	327247	12012576	
4046	170,00	190,00	8,50	AS K	NBR	4045	rear axle	DB	009 997 8846	327255	12012577	
47623	60,00	85,00	12,00	B RD	FPM	47991	gearbox	DB	007 997 5647		12012578	81-21108-20
114711	60,00	85,00	12,00	B RD	FPM	47991	gearbox	IVECO	4248 7132		12012578	
114712	60,00	85,00	12,00	B RD	FPM	47991	gearbox	RENAULT	50 00 803 236		12012578	
94632	60,00	85,00	12,00	B RD	FPM	47991	gearbox	ZF	0734 310 122		12012578	
109060	90,00	110,00	12,00	AW/BS LD	FPM	15246	crankshaft	BMW	11 14 1 255 012		12012579	
84171	90,00	110,00	12,00	AW/BS LD	FPM	15246	crankshaft	BMW	11 14 1 275 161		12012579	
48086	90,00	110,00	12,00	AW/BS LD	FPM	15246	crankshaft	BMW	11 14 1 706 785	702994	12012579	81-20745-40
15256	90,00	110,00	12,00	AW/BS LD	FPM	15246	crankshaft	BMW	11 14 1 706 999		12012579	
109120	90,00	110,00	12,00	AW/BS LD	FPM	15246	crankshaft	BMW	11 14 2 245 364	702994	12012579	81-20745-40
114477	90,00	110,00	12,00	AW/BS LD	FPM	15246	crankshaft	DEUTZ	1215 2257		12012579	
97331	90,00	110,00	12,00	AW/BS LD	FPM	15246	crankshaft	PORSCHE	999 113 26440		12012579	

dph-no	dim 1	dim 2	dim 3	Style	Material	dph oil seal no.	Application	Type	OEM-NO	Etring	Corteco	Reinz
111401	90,00	110,00	12,00	AW/BS LD	FPM	15246	crankshaft	PORSCHE	999 113 42641		12012579	
93641	100,00	120,00	15,00	AW/BS RD	FPM	82047	crankshaft	DEUTZ	214 8905		12012580	
70548	100,00	120,00	15,00	AW/BS RD F	FPM	82047	crankshaft	DEUTZ	242 1819	756121	12012580	81-25986-20
114630	105,00	130,00	15,00	AW/BS F LD	FPM	82048	crankshaft	DEUTZ	241 8366		12012581	
70549	105,00	130,00	15,00	AW/BS F LD	FPM	82048	crankshaft	DEUTZ	242 1820	756148	12012581	81-23301-40
114682	50,80	65,00	8,00	B WD	FPM	114348	crankshaft	MAN	81 32050 0219		12012592	
47329	50,00	70,00	13,5/8	BS SP	NBR	37350	front axle	DB	009 997 3346	009075	12012696	
47686	50,00	70,00	13,5/8	BS SP	NBR	37350	front axle	DB	010 997 6547	009075	12012696	
47687	50,00	70,00	13,5/8	BS SP	NBR	37350	front axle	DB	010 997 6647	009075	12012696	
37351	50,00	70,00	13,5/8	BS SP	NBR	37350	front axle	DB	010 997 6747	009075	12012696	
47712	50,00	70,00	13,5/8	BS SP	NBR	37350	front axle	DB	011 997 5547	009075	12012696	
4071	50,00	70,00	13,5/8	BS SP	NBR	37350	front axle	DB	011 997 6046	009075	12012696	
6512	32,00	47,00	10,00	W WD	FPM/ACM	97600	crankshaft	VW	026 103 085	325155	12012709	
112747	32,00	47,00	10,00	AS W WD	FPM/ACM	97600	crankshaft	VW	026 103 085 D		12012709	
111513	32,00	47,00	10,00	AS W WD	FPM/ACM	97600	crankshaft	VW	026 103 085 F		12012709	
34694	32,00	47,00	10,00	AS W WD	FPM/ACM	97600	crankshaft	VW	056 103 085	325155	12012709	
35510	32,00	47,00	10,00	AS W WD	FPM/ACM	97600	crankshaft	VW	056 103 085 B		12012709	
35013	32,00	47,00	10,00	AS W WD	FPM	37434	crankshaft	VW	068 103 085	325155	12012709	81-19299-10
114561	30,00	47,00	8,00	BS	ACM	81348	crankshaft	IVECO	4010 0790		12012768	
118920	30,00	47,00	8,00	BS	ACM	81348	crankshaft	IVECO	4010 0791		12012768	
114488	128,00	148,00	12,00	AW/BS WD	FPM	114430	crankshaft	IVECO	4010 1113		12012815	
47532	20,00	42,00	7,00	AS WD	NBR	48013	steering	DB	003 997 8147	277290	12012842	
109141	48,00	66,65	10,00	AS RD W	MVQ	37651	crankshaft	ALFA	60524745		12013046	
46725	77,00	98,4/103,00	6,3/19,3	A OF SF	NBR	82906	wheel hub	VOLVO	1 610 078		12013127	
82078	145,00	167,00	13,00	AS WD W	NBR	80456	axle	BPW	02 5664 46 57	817260	12013359	
35804	64,90	90,00	10,00	BS RD LA F	FPM	35885		VOLVO	267 268	587958	12013360	
35805	80,00	100,00	10,00	BS LD LA	FPM	35886		VOLVO	267 269	587966	12013361	81-35169-00
110723	80,00	100,00	10,00	BS LD LA	FPM	35886	PB 269	VOLVO	943 704-7	587966	12013361	81-35169-00
112541	70,00	90,00	10,00	AW/BS WD	FPM	114382	gearbox	DEUTZ	446 0152		12013363	
114734	70,00	90,00	10,00	AW/BS WD	FPM	114382	gearbox	MAN	06 56279 0211		12013363	
47659	105,00	130,00	12,00	AS	NBR	97860		DB	009 997 0647	282200	12013364	
114628	105,00	130,00	12,00	A/BS LD	FPM	48035	crankshaft	ZF	0734 310 124		12013364	
114704	60,00	74,00	10/8	AS W LD	FPM	113749	gearbox	DAF	0585 910		12013365	
114705	60,00	74,00	10/8	AS W LD	FPM	113749	gearbox	MAN	81 96501 0410		12013365	
114706	60,00	74,00	10/8	AS W LD	FPM	113749	gearbox	VOLVO	346 682-8		12013365	

dph-no	dim 1	dim 2	dim 3	Style	Material	dph oil seal no.	Application	Type	OEM-NO	Etring	Corteco	Reinz
114707	60,00	74,00	10/8	AS W LD	FPM	113749	gearbox	VOLVO	6 770 964-2		12013365	
114708	60,00	74,00	10/8	AS W LD	FPM	113749	gearbox	ZF	0734 300 024		12013365	
84615	85,00	110,00	13/9,5	A	NBR	81336	front axle	DAF	0015 484		12013388	
109158	85,00	110,00	13/9,5	A	NBR	81336	front axle	DAF	0015 485		12013388	
113936	85,00	110,00	13,00	A	NBR	19167	wheel hub	RVI	7701 003 394		12013388	
108798	85,00	110,00	13/9,5	A	NBR	81336	wheel accessory kit	VOLVO	947 270-5	300896	12013388	
114571	35,00	55,00	12,00	AS W RD	ACM	36204	crankshaft	BMW	11 14 1 255 014		12013416	
84172	35,00	55,00	12,00	AS W RD	ACM	36204	crankshaft	BMW	11 14 1 278 108		12013416	
36214	35,00	55,00	12,00	AS W RD	ACM	36204	crankshaft	BMW	11 14 1 709 632	587044	12013416	81-19886-10
37866	31,00	50,00	8,00	AS RD	FPM	37865	crankshaft	OPEL	646 263	330736	12013458	
68536	31,00	50,00	8,00	AS RD	FPM	37865	crankshaft	OPEL	646 265		12013458	81-25516-10
96024	31,00	50,00	8,00	AS RD	FPM	37865	crankshaft	OPEL	646 289	694739	12013458	
97203	35,00	50,00	8,00	AS W RD	FPM/ACM	97204	crankshaft	OPEL	646 290	694657	12013459	81-21798-00
115409	35,00	50,00	8,00	AS W RD	FPM/ACM	97204	crankshaft	RENAULT	77 00 859 691	507806	12013459	
109531	54,10	70/74	7,5/11	BA OF	NBR	111355	crankshaft	SCANIA	1 100 645		12013506	
47661	100,00	120,00	10,00	A W LD	FPM	48007	transmission	DB	009 997 2447		12013550	
114619	100,00	120,00	10,00	A W LD	FPM	48007		ZF	0734 310 131		12013550	
111583	85,00	105,00	10,00	AW/BS LD	FPM	82528	gearbox	DAF	0140 783	033464	12013757	
114766	85,00	105,00	10,00	AW/BS LD	FPM	82528	gearbox	DAF	0609 475	033464	12013757	
114767	85,00	105,00	10,00	AW/BS LD	FPM	82528	gearbox	DAF	0693 928	033464	12013757	
47536	85,00	105,00	10,00	B LD	FPM	4047	gearbox	DB	004 997 0647	033464	12013757	
46989	85,00	105,00	10,00	B LD	FPM	4047	gearbox	DB	004 997 2246	033464	12013757	
36791	85,00	105,00	10,00	B LD	FPM	4047	gearbox	DB	007 997 5947	033464	12013757	
47648	85,00	105,00	10,00	B LD	FPM	4047	gearbox	DB	008 997 3347	033464	12013757	
51744	85,00	105,00	10,00	B LD	FPM	4047	gearbox	DB	009 997 5947		12013757	
4646	85,00	105,00	10,00	B LD	FPM	4047	gearbox	DB	012 997 0647	033464	12013757	
112542	85,00	105,00	10,00	B LD	FPM	4047	gearbox	IVECO	4248 5827	033464	12013757	
114768	85,00	105,00	10,00	AW/BS LD	FPM	82528	gearbox	MAN	06 56289 0067	033464	12013757	
114769	85,00	105,00	10,00	AW/BS LD	FPM	82528	gearbox	MAN	81 96501 0966		12013757	
50681	85,00	105,00	10,00	B LD	FPM	4047	gearbox	MAN	81 96502 0208	033464	12013757	
95876	85,00	105,00	10,00	B LD	FPM	4047	gearbox	ZF	0734 310 109		12013757	
113906	52,00	75,00	14,70	BS	NBR	113905	crankshaft	PEUGEOT	3724 30		12013760	
15254	77,00	100,10	11,45	AW/BS LD	FPM	15248	crankshaft	OPEL	614 815	694665	12013857	81-20667-30
37637	26,00	42,00	8,00	A/BS RD	FPM	81064	crankshaft	OPEL	646 262		12013858	
81063	26,00	42,00	8,00	A/BS RD	FPM	81064	crankshaft	OPEL	646 267	755141	12013858	

dph-no	dim 1	dim 2	dim 3	Style	Material	dph oil seal no.	Application	Type	OEM-NO	Eling	Corteco	Reinz
68535	26,00	42,00	8,00	A/BS RD	FPM	81064	crankshaft	OPEL	646 270	755141	12013858	81-27295-00
109271	26,00	42,00	8,00	A/BS RD	FPM	81064	crankshaft	OPEL	646 816		12013858	
109147	35,00	47,00	7,00	AW RD	FPM/ACM	112614	crankshaft	CITROEN	7700 619 237		12013859	81-15855-40
110863	35,00	47,00	7,00	A W RD	FPM/ACM	112614	crankshaft	RENAULT	77 00 854 842	504483	12013859	81-35506-00
33550	35,00	47,00	7,00	AW RD	FPM/ACM	112614	crankshaft	VOLVO PC	1 306 333		12013859	
114757	78,00	100,00	10,00	AW/BS LD	FPM	114390	crankshaft	IVECO	4010 0490		12013860	
114756	78,00	100,00	10,00	AW/BS LD	FPM	114390	crankshaft	MAN	81 32050 0451		12013860	
114390	78,00	100,00	10,00	AW BS LD	FPM	114390	crankshaft	PEUGEOT	0514 14		12013860	
49099	127,00	150,00	12,00	A/BS LD	FPM	94791	crankshaft	VOLVO	471 056-2		12013863	
110486	127,00	150,00	12,00	A/BS LD	FPM	94791	crankshaft	VOLVO	477 119-2	518361	12013863	81-26294-10
70270	60,00	80,00	8/9,5	BS RD	FPM	81817	gearbox	VOLVO	267 316		12013864	
114678	50,00	68,00	10,00	A/B W RD	FPM	82470	crankshaft	PEUGEOT	0127 11	508470	12013865	81-16737-20
82471	50,00	68,00	10,00	A/B W RD	FPM	82470	crankshaft	RENAULT	77 00 719 274	508470	12013865	81-16737-20
82472	50,00	68,00	10,00	A/B W RD	FPM	82470	crankshaft	RENAULT	77 00 866 877	508470	12013865	81-16737-20
82970	50,00	68,00	10,00	A/B W RD	FPM	82470	crankshaft	RENAULT	77 01 349 140		12013865	
82481	50,00	68,00	10,00	A/BS W RD	FPM	82470	crankshaft	VOLVO	8 414 241-3		12013865	81-16737-20
46810	110,00	140,00	12/21	SP	NBR	82425	front axle	VOLVO	1 587 792	522910	12013870	
59232	80,00	110,05	12,00	BS LD	FPM	95248	differential	VOLVO	948 448-6		12013871	81-35141-00
37640	80,00	98,00	10,00	A/BS LD	FPM	81060	crankshaft	OPEL	614 811		12013882	
50179	80,00	98,00	10,00	A/BS LD	FPM	81060	crankshaft	OPEL	614 820		12013882	81-24908-10
81062	80,00	98,00	10,00	A/BS LD	FPM	81060	crankshaft	OPEL	614 821	590797	12013882	81-24908-10
94499	80,00	98,00	10,00	A/BS LD	FPM	81060	crankshaft	OPEL	614 830	590797	12013882	81-24908-10
109140	82,00	105,00	12,00	AS W LD	FPM	3914	crankshaft	ALFA	60517110	232300	12013892	
3915	82,00	105,00	12,00	AS W LD	FPM	3914	crankshaft	VW	056 103 051 A	232300	12013892	
34428	130,00	160,00	15,00	AS W LD	MVQ	48518	crankshaft	SCANIA	231 938	587079	12013893	81-25014-10
69285	130,00	160,00	15,00	AW/BS LD	FPM	93307	crankshaft	SCANIA	366 303	587070	12013893	81-25014-10
4067	48,00	72,00	7/9	AS2	NBR	50513	wheel hub	VW	211 501 317	394009	12013894	
109143	42,00	62,00	10,00	AS RD	ACM	35050	crankshaft	ALFA	60735515		12013896	
96322	42,00	62,00	10,00	AS RD	ACM	35050	crankshaft	BMW	11 14 1 255 010		12013896	
109119	42,00	62,00	10,00	AS RD	ACM	35050	crankshaft	BMW	11 14 1 715 101		12013896	
117339	42,00	62,00	10,00	AS RD	ACM	35050	gearbox	MAN	81 96502 0200		12013896	
114586	42,00	62,00	10,00	AS RD	ACM	35050	crankshaft	PEUGEOT	0514 21	040363	12013896	81-21001-10
114587	42,00	62,00	10,00	AS RD	ACM	35050	crankshaft	RENAULT	79 10 247 576	040363	12013896	
33551	42,00	62,00	10,00	AS RD	ACM	35050	crankshaft	VOLVO	247 576		12013896	81-21001-10
33552	42,00	62,00	10,00	AS RD	ACM	35050	crankshaft	VOLVO PC	1 218 034	040363	12013896	

dph-no	dim 1	dim 2	dim 3	Style	Material	dph oil seal no.	Application	Type	OEM-NO	Eling	Corteco	Reinz
35051	42,00	62,00	10,00	AS RD	ACM	35050	crankshaft	VW	021 105 247 A	040363	12013896	81-21001-10
35511	42,00	62,00	10,00	AS RD	ACM	35050	crankshaft	VW	021 105 247 B	040363	12013896	81-21001-10
35613	92,00	110,00	10,00	AW LD	MVQ	16051	crankshaft	VOLVO PC	1 266 604		12013897	
33548	92,00	110,00	10,00	AS LD W	MVQ	16051	crankshaft	VOLVO PC	430 118-0	044598	12013897	81-25583-00
111534	65,00	85,00	10,00	AS2 WD	NBR	111533	wheel hub	VW	291 501 317	046094	12013927	
4144	55,00	68,00	8,50	AS W	NBR	36319	front axle	VW	251 407 641 A	284459	12013929	
48162	55,00	68,00	8,50	AS W	NBR	36319	front axle	VW	281 407 641 C	284459	12013929	
81138	28,00	38,00	7,00	AS RD	FPM	81139		FORD	6 135 090	562653	12013949	81-26268-00
34672	75,00	95,00	13,00	CS green	NBR	51719	gearbox	DB	000 997 6347	529001	12013987	81-35086-00
47387	75,00	95,00	13,00	CS	NBR	51719	gearbox	DB	011 997 2546	529001	12013987	
112976	70,00	102,00	14,50	AS W LD SP	FPM	112987	crankshaft	VOLVO	1 524 838		12013988	
37211	85,73	114,33	13/9,5	A/BS RD W	FPM	81284	crankshaft	VOLVO	424 983-5	570495	12013988	81-25952-20
81284	85,73	114,33	13/9,5	A/BS RD W	FPM	81284	crankshaft	VOLVO	469 507-8		12013988	
117414	180,00	200,00	12,00	A/B W WD	FPM	81338	wheel hub	IVECO	4010 0670		12014190	
84200	180,00	200,00	12,00	A/B W WD	FPM	81338	wheel hub	IVECO	4010 0673		12014190	
36300	76,20	101,60	11,90	A/BS RD felt	FPM	94792	crankshaft	VOLVO	471 055-4		12014191	
119100	70,00	90,00	12,00	A/CS WD W	ACM	81631	wheel hub	IVECO	4010 0480		12014289	
81571	70,00	90,00	12,00	A/CS WD W	ACM	81631	wheel hub	IVECO	4010 0483		12014289	
114487	120,00	140,00	14,00	AW/BS WD	FPM	114431	crankshaft	IVECO	4010 1103		12014302	
111767	20,00	40,00	5,5/8	C RD SF	ACM	111766	crankshaft	FIAT	4000 4810		12014346	
114664	164,4/168	188 / 190,00	30 / 32	BS WD	ACM	50796	wheel hub	VOLVO	1 591 903	522880	12014351	
84628	164,4/168	188 / 190,00	30 / 32	BS WD	ACM	50796	wheel hub	VOLVO	944 666-7	522880	12014351	
35019	65,00	90,00	15,00	B RD	FPM	47957	crankshaft	DB	006 997 5446	283983	12014380	
47673	65,00	90,00	13,00	AW/BS RD VL	FPM	84257	crankshaft	DB	009 997 9447		12014380	
114742	70,00	100,00	13,00	A/CS WD W	ACM	81355	wheel hub	IVECO	4010 1700		12014381	
118923	70,00	100,00	13,5/15,00	KS SP	FPM	114864	wheel hub	IVECO	4010 2280		12014381	
114743	70,00	100,00	13,5/15,00	KS SP	FPM	114864	wheel hub	IVECO	4010 2283		12014381	
80631	88,00	108,00	11,10	AW/BS LD	FPM	80639	crankshaft	FORD	6 165 502	750476	12014402	
109704	88,00	108,00	11,10	AW/BS LD	FPM	80639	crankshaft	SAAB	91 74 202		12014402	
47598	30,00	40,00	7,00	AS RD W	FPM	47982	camshaft	DB	006 997 5347	598993	12014403	
94507	30,00	40,00	7,00	AS RD W	FPM	47982	camshaft	RENAULT	77 03 087 189	508489	12014403	81-15512-50
95572	42,00	56,00	7,00	AS W RD	FPM	82475	differential	DEUTZ	117 4560		12014404	
96247	42,00	56,00	7,00	AS W RD	FPM	82475	differential	FORD	1 669 254	757497	12014404	
80632	42,00	56,00	7,00	AS W RD	FPM	82475	differential	FORD	6 165 498	757497	12014404	81-51109-30
47377	145,00	175,00	13,00	A/B W blue	NBR	82427	rear axle	DB	011 997 0146	294500	12014407	81-91001-00

dph-no	dim 1	dim 2	dim 3	Style	Material	dph oil seal no.	Application	Type	OEM-NO	Elring	Corteco	Reinz
36407	145,00	175,00	13,00	A/B W blue	NBR	82427	rear axle	DB	011 997 1246		12014407	
114623	100,00	130,00	12,00	A/CS WD W	ACM	81353	crankshaft	IVECO	4010 0460		12014422	
117408	100,00	130,00	12,00	A/CS WD W	ACM	81353	crankshaft	IVECO	4010 0463		12014422	
114721	65,00	85,00	13,00	AW/BS LD	FPM	114374	gearbox	VOLVO	6 797 452-7		12014424	
47512	105,00	130,00	12,00	AW/BS RD vlies	FPM	112532	crankshaft	DB	003 997 0747	524972	12014447	
47538	105,00	130,00	12,00	A/BS LD	FPM	48035	crankshaft	DB	004 997 1047		12014447	
47594	105,00	130,00	12,00	AW/BS RD vlies	FPM	112532	crankshaft	DB	006 997 2347	524972	12014447	
47662	105,00	130,00	12,00	AW/BS RD vlies	FPM	112532	crankshaft	DB	009 997 3447	524972	12014447	
36222	105,00	130,00	12,00	AW/BS RD vlies	FPM	112532	crankshaft	DB	012 997 7447	524972	12014447	
61649	125,00	160,00	15,00	AS W	NBR	61648	crankshaft	SCANIA	375 086		12014463	
61651	110,00	140,00	15,00	AS W SP	NBR	61650	front axle	SCANIA	375 087		12014464	
37061	29,00	50,00	10/7	AW/BS LD	ACM	82254	injection pump	VOLVO	424 580-9	755087	12014476	
70475	25,00	35,00	7,00	B	NBR	4378	gearbox	SCANIA	254 635	038083	12014487	
94944	38,00	50,00	8,00	A/BS RD	FPM	111535	crankshaft	OPEL	646 269	763918	12014494	81-28236-00
110600	38,00	50,00	8,00	A/BS RD	FPM	111535	crankshaft	OPEL	646 271	763918	12014494	
51454	90,00	104,00	11,00	A/BS LD	FPM	93733	crankshaft	OPEL	614 819	694770	12014523	81-27294-10
59233	90,00	104,00	11,00	A/BS LD	FPM	93733	crankshaft	OPEL	614 829	694770	12014523	81-27294-10
119101	134,00	152,00	14,00	A/CS WD W	ACM	81344	wheel hub	IVECO	4010 0650		12014598	
81572	134,00	152,00	14,00	A/CS WD W	ACM	81344	wheel hub	IVECO	4010 0653		12014598	
111641	85,00	110,00	12,00	A/CS W WD	ACM	83908	wheel hub	IVECO	4010 0470		12014599	
119102	140,00	170,00	14,00	A/CS WD W	ACM	81343	crankshaft	IVECO	4010 0660		12014601	
81573	140,00	170,00	14,00	A/CS WD W	ACM	81343	crankshaft	IVECO	4010 0663		12014601	
80653	42,00	52,00	7,5/8	A/BS W RD	FPM	80652	crankshaft	BMW	11 14 1 714 617	748889	12014607	81-27556-00
95835	44,00	60,00	10,00	AS W RD	FPM	80654	crankshaft	BMW	11 14 1 308 342	761796	12014608	
80655	44,00	60,00	10,00	AS W RD	FPM	80654	crankshaft	BMW	11 14 1 721 560	761796	12014608	81-28498-00
114590	44,00	60,00	10,00	AS W RD	FPM	80654	crankshaft	LANCIA	46108224		12014608	
111591	25,00	35,00	7,00	B	NBR	4378	gearbox	DAF	0140 335	038083	12014616	
47240	25,00	35,00	7,00	B	NBR	4378	gearbox	DB	006 997 4946	038083	12014616	
117393	25,00	35,00	7,00	B	NBR	4378	gearbox	IVECO	4010 1080		12014616	
117303	25,00	35,00	7,00	B	NBR	4378	gearbox	MAN	06 56261 1609	038083	12014616	81-35123-00
35212	25,00	35,00	7,00	B	NBR	4378	gearbox	MAN	81 96501 0521	038083	12014616	
81460	25,00	35,00	7,00	BAB SL	NBR	4468	transfer gearbox	SCANIA	329 638		12014616	
119406	25,00	35,00	7,00	B	NBR	4378	gearbox	VOLVO	6 876 348-1	038083	12014616	
82325	25,00	35,00	7,00	B	NBR	4378	gearbox	ZF	0634 300 302		12014616	
37599	140,00	164,00	20/23,50	SP	FPM	50173	rear axle	VOLVO	1 522 372	922277	12014656	

dph-no	dim 1	dim 2	dim 3	Style	Material	dph oil seal no.	Application	Type	OEM-NO	Elring	Corteco	Reinz
104115	70,00	90,00	10,00	AW/BS RD	FPM	114379	crankshaft	DAF	1226 734	763144	12014700	81-15287-00
114691	55,00	68,00	8,00	AS/B	ACM	37352	crankshaft	DB	008 997 0647		12014730	
37038	55,00	68,00	8,00	AS/B	ACM	37352	crankshaft	DB	008 997 6147		12014730	
37037	55,00	68,00	8,00	AS/B	ACM	37352	crankshaft	DB	014 997 6747		12014730	
111759	100,00	125,00	13,00	AS W WD	NBR	111758	crankshaft	RVI	5010 067 534		12014731	
61643	113,00	136,00	10,90	A SP	NBR	61642	rear axle	SCANIA	297 999	586781	12014734	
114735	70,00	90,00	10,00	AS W LD	FPM	47944		DAF	0140 784	348856	12014736	
114736	70,00	90,00	10,00	AS W LD	FPM	47944	gearbox	MAN	81 96502 0251		12014736	
114737	70,00	90,00	10,00	AS W LD	FPM	47944	gearbox	VOLVO	6 876 131-1		12014736	
114738	70,00	90,00	10,00	AS W LD	FPM	47944	gearbox	ZF	0734 310 128		12014736	
80835	145,00	175,00	13,00	AW/B	FPM	59311	rear axle	DB	013 997 5947	768057	12014739	81-35112-00
36646	145,00	175,00	13,00	AW/B	FPM	59311	rear axle	DB	013 997 9447	768057	12014739	
114656	145,00	175,00	13,00	AW/B	FPM	59311	wheel hub	MAN	06 56289 0333		12014739	
51423	145,00	175,00	14,00	A/BS	NBR	81021	rear axle	DB	013 997 0547	768065	12014740	81-91002-00
51230	145,00	175,00	14,00	A/BS	NBR	81021	rear axle	DB	016 997 5647	768065	12014740	
82113	145,00	175,00	14,00	A/BS W	NBR	81021	rear axle	MAN	06 56289 0332	768065	12014740	
6652	145,00	175,00	14,00	A/BS blue	NBR	81021	rear axle	MAN	06 56289 0335	768065	12014740	81-91002-00
6649	145,00	175,00	14,00	A/BS blue	NBR	81021	rear axle	MAN	81 96501 0861		12014740	
46716	110,00	140,00	12/19	SP	FPM	117745	front wheel hub	VOLVO	1 089 552	522911	12014742	81-35101-00
47360	72,00	105,00	13,00	C WD	FPM	48048	front axle	DB	010 997 3746	008745	12014743	
47362	72,00	105,00	13,00	C WD	FPM	48048	front axle	DB	010 997 5346	008745	12014743	
95009	72,00	105,00	13,00	C WD	FPM	48048	front axle	DB	013 997 4947		12014743	
46636	72,00	105,00	13,00	C WD	FPM	48048	front axle	MAN	06 56279 0073	008745	12014743	
117300	72,00	105,00	13,00	C WD	FPM	48048	differential	MAN	06 56279 0366		12014743	
70528	72,00	105,00	13,00	C WD	FPM	48048	transfer gearbox	SCANIA	386 968	008745	12014743	
69293	80,00	150,00	12/20	SP RD LA	FPM	69292	differential carrier	VOLVO	1 522 894	588008	12014744	81-35129-00
36626	80,00	130,20	12/20	RD LA SP	FPM	82426	automatic gearbox	VOLVO	1 522 895	588016	12014745	81-35131-00
69291	90,00	125,25	10,00	BS RD LA	FPM	69290	rear axle	VOLVO	948 642-8	587991	12014746	81-35142-00
47571	26,00	37,00	7/8	AS V W	NBR	47945	steering	DB	005 997 3747	006408	12014826	81-35069-00
93878	26,00	37,00	7/8	AS V W	NBR	47945	steering	DB	008 997 9447	006408	12014826	
114553	26,00	37,00	7/8	AS V W	NBR	47945	steering	SCANIA	318 996	006408	12014826	81-35069-00
36627	26,00	37,00	7/8	AS V W	NBR	47945	steering	VOLVO	341 050	006408	12014826	81-35069-00
93879	26,00	37,00	7/8	AS V W	NBR	47945	crankshaft	ZF	0770 198 103		12014826	
82871	30,00	47,00	10/7	AS W WD F	ACM	82870	crankshaft	SCANIA	1 109 869		12014828	
112656	42,00	72,00	8,00	AS W WD	ACM	112655	crankshaft	SCANIA	1 109 871		12014829	

dph-no	dim 1	dim 2	dim 3	Style	Material	dph oil seal no.	Application	Type	OEM-NO	Elring	Corteco	Reinz
70455	42,00	72,00	8,00	AS W WD	ACM	112655	crankshaft	SCANIA	170 226		12014829	
114589	42,00	72,00	8,00	AS W WD	ACM	112655	crankshaft	SCANIA	310 953		12014829	81-25136-10
104542	35,00	62,00	7,00	AS W WD	ACM	84536	camshaft	SCANIA	1 109 870	580202	12014830	81-26592-10
84537	35,00	62,00	7,00	AS W WD F	ACM	84536	injection pump	SCANIA	310 951		12014830	
111780	100,00	118,00	10,00	A/BS LD	FPM	111779	crankshaft	FIAT	4010 0340		12014831	
48907	120,00	140,00	13,00	AW/BS LD	FPM	112531	crankshaft	DB	005 997 2647		12014877	
47596	120,00	140,00	13,00	AW/BS LD	FPM	112531	crankshaft	DB	006 997 3347	090158	12014877	
47256	120,00	140,00	13,00	AW/BS LD	FPM	112531	crankshaft	DB	007 997 2446	090158	12014877	
36223	120,00	140,00	13,00	AW/BS LD	FPM	112531	crankshaft	DB	013 997 1447	562920	12014877	81-23113-00
69541	120,00	140,00	13,00	AW/BS LD	FPM	112531	crankshaft	DB	014 997 1347	562920	12014877	
36178	120,00	140,00	13,00	AW/BS LD	FPM	112531	crankshaft	MAN	51 01510 0133	090158	12014877	
82506	60,32	79,37	9,52	AS RD	FPM	82504	crankshaft	PERKINS	2418 F 436		12014981	
113946	100,00	135,00	13,00	AS WD	NBR	113945	wheel hub	DAF	0647 330		12015029	
111778	55,00	70,00	10,00	A/BS RD SF	FPM	111777	injection pump	FIAT	4010 0320		12015093	
111776	55,00	70,00	8,00	A/BS RD SF	FPM	111775	crankshaft	FIAT	4010 0330		12015120	
109145	84,00	105,00	12,00	AS W LD	MVQ	50510	crankshaft	ALFA	119 00 01 177 00		12015180	
47674	90,00	110,00	13,00	A/BS	NBR	48024	rear axle	DB	010 997 0147	567779	12015249	
47680	90,00	110,00	13,00	A/BS	NBR	48024	rear axle	DB	010 997 5347	567779	12015249	
47696	90,00	110,00	13,00	A/BS	NBR	48024	rear axle	DB	010 997 8647	567779	12015249	
96716	55,00	75,00	9,00	BS RD	FPM	96717	gearbox	SCANIA	1 318 388		12015253	
114697	55,00	75,00	9,00	BS RD	FPM	96717	crankshaft	SCANIA	378 620		12015253	
84730	80,00	100,00	10/8	BS WD LA	ACM	112617	crankshaft	SCANIA	1 335 243		12015254	
34426	80,00	100,00	13/15	CS WD SF	ACM	118176	rear axle	SCANIA	124 268		12015254	
36169	80,00	100,00	13,00	BS blue	NBR	94928	crankshaft	SCANIA	388 728		12015254	
108817	180,00	205,00	15,00	A/BS W	FPM	108818	crankshaft	VOLVO	1 543 896		12015255	81-35206-00
61492	85,00	105,00	12,00	A/BS LD W	FPM	61492	crankshaft	VW	026 103 051 A		12015256	
69585	85,00	105,00	11,00	AS W LD	FPM	84358	crankshaft	VW	068 103 051 G		12015256	81-35353-00
47540	45,00	67,00	8,00	AS W RD	FPM	36206	crankshaft	DB	004 997 1547		12015258	
47546	40,00	70,00	12/16	BS RD	FPM	48015	differential	DB	004 997 4747		12015258	
47378	40,00	70,00	12/16	SP RD	ACM	48005	rear axle	DB	011 997 0446	312444	12015258	81-35073-00
81898	40,00	70,00	12/16	SP RD	ACM	48005	rear axle	DB	014 997 4947	312444	12015258	
47355	46,00	64,00	8,00	B RD	FPM	47998	gearbox	DB	010 997 2946	283827	12015259	
47700	46,00	64,00	8,00	B RD	FPM	47998	gearbox	DB	010 997 9447	283827	12015259	
95611	46,00	64,00	8,00	B RD	FPM	47998	gearbox	DB	015 997 0347	701343	12015259	
47630	40,00	70,00	7/8	B	FPM	47987	differential	DB	007 997 6747		12015261	

dph-no	dim 1	dim 2	dim 3	Style	Material	dph oil seal no.	Application	Type	OEM-NO	Elring	Corteco	Reinz
47650	40,00	70,00	7/8	B	FPM	47987	differential	DB	008 997 3647		12015261	
47657	40,00	70,00	7/8	B	FPM	47987	differential	DB	008 997 8147		12015261	
47609	40,00	70,00	13,00	special	FPM	47986		DB	007 997 0947		12015262	
47627	40,00	70,00	13,00	SP	FPM	47986		DB	007 997 6347		12015262	
47628	40,00	70,00	13,00	SP	FPM	47986		DB	007 997 6547		12015262	
47676	95,00	115,00	13,00	A/BS blue	NBR	48025	wheel hub	DB	010 997 2447	567795	12015263	81-35094-00
47697	95,00	115,00	13,00	A/BS blue	NBR	48025	wheel hub	DB	010 997 8747	567795	12015263	
47672	95,00	120,00	13,00	A/BS	NBR	48026	wheel hub	DB	009 997 9247	567787	12015264	
47682	95,00	120,00	13,00	A/BS	NBR	48026	wheel hub	DB	010 997 5547	567787	12015264	
47698	95,00	120,00	13,00	A/BS	NBR	48026	wheel hub	DB	010 997 8847	567787	12015264	
47722	95,00	120,00	13,00	A/BS	NBR	48026	wheel hub	DB	012 997 1147	567787	12015264	
117415	180,00	200,00	17,00	A/BS WD	FPM	83906	crankshaft	IVECO	4010 1730		12015265	
83907	180,00	200,00	17,00	AW/BS WD	FPM	83906	crankshaft	IVECO	4010 1733		12015265	
111384	36,00	56,00	10/13,6	A/BS LD W SP	ACM	111393	cranshaft	FIAT	4000 4620		12015267	
96645	36,00	54,00	7,00	AS WD	ACM	96644	differential	RENAULT	77 03 087 087	107794	12015283	
116997	95,00	120,00	13,00	BS LD	FPM	82399	crankshaft	RVI	5010 242 655		12015304	
37868	17,00	28,00	7,00	B	NBR	37867	crankshaft	OPEL	819 830		12015322	
82436	80,00	100,00	8,00	AS W LD	FPM/ACM	82435	crankshaft	RENAULT	77 00 859 692	507822	12015352	
84169	38,00	50,00	7,00	ASW WD	FPM	36116		BMW	11 12 1 265 435		12015381	
19977	38,00	50,00	7,00	AS W WD	FPM	36116	engine	BMW	11 12 1 285 609	586668	12015381	81-24641-10
111394	60,40	80,00	12,00	BS RD SP	FPM	109799	crankshaft	MAN	51 01510 0152	323780	12015383	81-24895-00
109688	110,00	130,00	13,00	A/BS LD	FPM/PTFE	109691	crankshaft	MAN	51 01510 0151	323772	12015384	81-33801-00
47717	100,00	125,00	13,00	A/BS	NBR	48030	front axle	DB	011 997 7247	562874	12015406	
47728	100,00	125,00	13,00	A/BS	NBR	48030	front axle	DB	012 997 9147	562874	12015406	
115414	27,95	70,00	10,00	ASW RD	ACM	115413	differential	RENAULT	77 03 087 148		12015423	
115415	85,00	105,00	8,00	AS W LD	ACM/FPM	109243	camshaft	RENAULT	77 03 087 190	508462	12015424	81-23708-50
115416	25,00	42,00	7,00	AS W RD	FPM	112618	camshaft	RENAULT	77 03 087 192	508544	12015425	81-26389-30
118605	25,00	42,00	7,00	AS W RD	FPM	112618	camshaft	RVI	7703 087 192		12015425	
96434	87,00	100,00	8,50	AS LD	FPM	97874	crankshaft	OPEL	614 825	060110	12015429	81-53299-00
94863	40,00	52,00	6,00	AS RD	FPM	94862	crankshaft	OPEL	614 822	060120	12015430	
94336	18,00	32,00	6,00	AS RD	ACM	94335	oil pump	OPEL	646 268	490800	12015450	
32639	145,00	175,00	13,00	A/B W blue	NBR	82427	rear axle	MAN	06 56289 0334	817023	12015499	81-91001-00
109841	145,00	175,00	13,00	C	FPM	97801	wheel hub	MAN	81 96501 0860	033146	12015499	
114633	110,00	140,00	13,00	A/BS	NBR	114414	wheel hub	DB	017 997 1147	457680	12015500	
94407	125,00	150,00	15/13	A/BS WD F	NBR	94406	rear axle	DB	015 997 5647	210294	12015501	

dph-no	dim 1	dim 2	dim 3	Style	Material	dph oil seal no.	Application	Type	OEM-NO	Elring	Corteco	Reinz
114514	128,00	144/152,30	11/25	SP	FPM	114458	wheel hub	IVECO	4010 2103		12015506	
119105	95,00	130,00	16,00	KA SP	FPM/ACM	93221	crankshaft	IVECO	4010 2140		12015509	
82965	95,00	130,00	16,00	KA SP	FPM/ACM	93221	crankshaft	IVECO	4010 2143	454000	12015509	
82346	154,00	180,00	15,00	AW/BS LD F	FPM	82345	crankshaft	DAF	0558 114		12015530	81-28539-00
109166	154,00	180,00	15,00	AW/BS LD F	FPM	82345	crankshaft	DAF	0682 961		12015530	
97821	154,00	180,00	15,00	AW/BS LD F	FPM	82345	crankshaft	DAF	1275 083		12015530	81-28539-00
82348	100,00	124,00	13,00	AW/BS LD F	FPM	82347	crankshaft	DAF	0281 986		12015531	
119104	85,00	110,00	14,00	A/CS WD W	FPM	81350	crankshaft	IVECO	4010 2050		12015544	
83900	85,00	110,00	14,00	A/CS WD W	FPM	81350	crankshaft	IVECO	4010 2053		12015544	
95898	60,45	76,18	10,00	AS LD W	FPM	95897	crankshaft	FORD	6 803 967	693201	12015546	81-20286-00
32333	66,67	89,30	10,00	AS W RD	FPM	32072	crankshaft	FORD	6 175 915		12015552	
111528	23,00	35,00	6,50	A W RD	ACM	111527	crankshaft	VW	084 311 113 A		12015553	
80789	21,80	35,00	7,00	AS	NBR	80788	gearbox	VW	085 311 113		12015554	
111530	48,00	62,00	7,00	AS WD	ACM	111529	differential	VW	084 409 189 B		12015555	
81455	40,00	60,00	10/12	AS W WD	NBR	81454	differential	VW	02A 301 189		12015556	
111532	57,00	71,00	7/6,5	AS WD	ACM	111531	differential	VW	084 409 189 C		12015557	
120457	30,00	37,00	4,00	AO	NBR	21609	gearbox	RVI	5010 439 193		12015561	
114663	160,00	185,00	14,00	A WD	ACM	114423	crankshaft	DAF	0259 939		12015609	
118922	160,00	185,00	14,00	A WD	ACM	114423	crankshaft	DAF	0259 940		12015609	
115506	35,00	47,00	6,00	AS RD	FPM	113719	crankshaft front	VOLVO PC	6 842 273	336999	12015674	
80636	79,38	95,25	11,00	AW/BS LD	FPM	80636	crankshaft	FORD	1 641 893	763713	12015675	
116379	79,38	95,25	11,00	AW/BS LD	FPM	80636	crankshaft	FORD	6 112 201		12015675	
95354	90,00	145,00	10/15	A/B SP	FPM	94049	differential	VOLVO	1 523 239	435180	12015693	81-35132-00
82537	125,00	143,00	13,00	AS WD W	NBR	80457	wheel hub	BPW	02 5664 26 57	817252	12015710	
114692	55,00	68,00	8,00	A/BS RD	FPM	97403	camshaft	MAN	06 56279 0352		12015711	
97397	55,00	68,00	8,00	A/BS RD	FPM	97403		OPEL	638 196	477010	12015711	81-34158-00
114486	150,00	170,00	16,00	AW/BS WD	FPM	114426	crankshaft	IVECO	4010 1093		12015745	
114644	125,00	150,00	15,00	AS/BW LD	FPM	51252	crankshaft	IVECO	4010 1400		12015746	81-24476-20
97929	27,00	42,00	6,00	AS RD W	ACM	97928	crankshaft	FORD	6 184 211		12015750	
81802	100,00	140,00	15/20,5	CS SP	NBR	81800	wheel hub	DAF	1238 034		12015758	
81462	45,00	65,00	10/8	A/BS LD	FPM	81461	gearbox	SCANIA	388 528		12015765	
114485	80,00	100,00	10,00	AW/BS WD	FPM	47995	differential	IVECO	4010 0860		12015770	
47626	70,00	90,00	10,00	AS W LD	FPM	47944	gearbox	DB	007 997 6047	348856	12015772	
119103	140,00	165,00	15,00	A/BS LD W	FPM	81349	crankshaft	IVECO	4010 1430		12015780	
81574	140,00	165,00	15,00	A/BS LD W	FPM	81349	crankshaft	IVECO	4010 1433		12015780	

dph-no	dim 1	dim 2	dim 3	Style	Material	dph oil seal no.	Application	Type	OEM-NO	Elring	Corteco	Reinz
83901	60,00	90,00	14/16,30	SP	FPM/ACM	81354	differential	IVECO	4010 2263		12015791	
119106	60,00	90,00	14/16,30	SP	FPM/ACM	81354	differential	IVECO	4010 2660		12015791	
119107	70,00	90,00	13,5/14,50	SP	FPM	95465	crankshaft	IVECO	4010 2270		12015793	
94797	70,00	90,00	13,5/14,50	SP	FPM	95465	crankshaft	IVECO	4010 2273	013930	12015793	
15252	155,00	180,00	15,00	A/BS LD W	FPM	81702	crankshaft	VOLVO	469 336-2	760315	12015806	81-25934-00
36318	155,00	180,00	15,00	A/BS LD W	FPM	81702	crankshaft	VOLVO	821 755-6	760315	12015806	81-25934-00
111791	30,00	52,00	7,00	A/BS RD	FPM	111790	crankshaft	FIAT	4000 4770		12015855	
47683	75,00	95,00	13,00	A/BS	NBR	48021	rear axle	DB	010 997 5747	562866	12015884	
47689	75,00	95,00	13,00	A/BS	NBR	48021	rear axle	DB	010 997 7147	562866	12015884	
47730	75,00	95,00	13,00	A/BS	NBR	48021	rear axle	DB	013 997 1147	562866	12015884	81-35087-00
113953	62,00	80,00	10,00	A/BS W blue	NBR	113952	transmission shaft	DB	015 997 0147	801230	12015885	
47692	120,00	145,00	15/12	A/BS	NBR	48023	wheel hub	DB	010 997 8047	567108	12015886	
47693	120,00	145,00	13,00	CS	NBR	51716	front & rear axle	DB	010 997 8147	567108	12015886	
47690	115,00	140,00	13,00	A/BS blue	NBR	48022	rear axle	DB	010 997 7847	562882	12015887	
47691	115,00	140,00	13,00	A/BS blue	NBR	48022	rear axle	DB	010 997 7947	562882	12015887	
47694	115,00	140,00	13,00	A/BS blue	NBR	48022	rear axle	DB	010 997 8447	562882	12015887	
112540	115,00	140,00	13,00	A BS blue	NBR	48022	rear axle	IVECO	4203 1150		12015887	
119109	65,00	90,00	13/14,50	KA/KB SP	FPM/ACM	109807	crankshaft	IVECO	4010 2290		12015928	
109804	65,00	90,00	13/14,50	KA/KB SP	FPM/ACM	109807	crankshaft	IVECO	4010 2293		12015928	
114726	65,00	90,00	13,00	BS	NBR	48401	differential	ZF	0634 309 092		12015935	
114638	120,00	150,00	15/12	AW/BS	NBR	84716	wheel hub	DB	020 997 5847		12016441	
114495	140,00	170,00	17,00	KA	FPM	114449	wheel hub	RVI	5000 823 891		12016451	
112610	42,00	65,00	10,00	AW BS RD	FPM	112609	crankshaft	IVECO	4010 0870		12016489	
119559	40,00	55,00	7,00	AW/BS RD	FPM	118615	camshaft	Fiat	4643 4591	457220	12016528	
112427	90,00	145,00	10,00	A/BS LD	FPM	112716	automatic gearbox	VOLVO	1 652 776	435340	12016675	81-35136-00
93430	125,00	150,00	14,00	AS SP	NBR	93429	crankshaft	SCANIA	1 334 535	457590	12016695	
109594	86,00	105,00	5/6	AS SP W	NBR	109593	wheel hub	DB	021 997 8947		12016794	
96969	20,00	30,00	7/8	AS W blue	NBR	96968	crankshaft	ZF	0770 080 256		12016820	
114489	48,00	62,00	10,00	AW/BS WD	FPM	114440	crankshaft	IVECO	4010 1353		12016835	
95894	150,00	180,00	10,00	BS2 SP	STEEL	95893	crankshaft	VOLVO	1 524 281		12016843	
96967	25,00	38,00	7,00	AW blue	NBR	96966	crankshaft	ZF	0770 080 286		12016917	
35455	23,90	40,00	8,00	AS RD	ACM	96872	gearbox	VW	020 311 113 B		12016924	
115456	35,00	50,00	8,00	AS WD W	FPM	112621	crankshaft	PEUGEOT	0236 14	302589	12016927	81-21798-50
81089	50,00	65,20	10,00	AS W WD	ACM	104440	gearbox	VW	020 301 189 H	527858	12016928	
111232	50,00	65,20	10,00	AS W WD	ACM	104440	gearbox	VW	020 301 189 N	527858	12016928	

dph-no	dim 1	dim 2	dim 3	Style	Material	dph oil seal no.	Application	Type	OEM-NO	Elring	Corteco	Reinz
104441	50,00	65,20	10,00	AS W WD	ACM	104440	gearbox	VW	020 301 189 T	527858	12016928	
114626	100,00	130,00	13,00	AW/BS	NBR	61447	front-/rear axle	DB	019 997 4747		12016930	
116234	140,00	164,00	20/23,50	SP	FPM	50173	rear axle	VOLVO	1 672 249	222757	12016932	
111526	25,00	40,00	8,00	AS RD	ACM	111525	gearbox	VW	016 311 113 B		12016989	
112971	150,00	180,00	12,00	AS	NBR	112971	axle				12017022	
97905	57,15	81,86	7/14	AS SF	NBR	97904	wheel hub	FORD	6 143 628		12017122	
4292	92,00	110,00	7,00	AS LD W	FPM	49103	crankshaft	VOLVO PC	6 842 093-4	044590	12017124	
113961	69,00	80,00	4,2/8,5	B OF SF	NBR	113960	rear axle	RVI	5000 387 566		12017138	
114755	75,00	100,00	10/13	KA	NBR	114389	wheel hub	SCANIA	1 313 719		12017173	
112282	75,00	100,00	10/13	KA	NBR	114389	wheel hub	SCANIA	1 409 890	222610	12017173	
119335	111,12	146,05	14,28	SP	NBR	97195	axle	TRAILOR	6502085T		12017210	
114565	34,90	62,00	8,00	A/BS LD	ACM	114332	injection pump	VOLVO	1 546 221	760240	12017218	81-33677-00
117539	80,00	100,00	10,00	A/BS RD	ACM	120475	retainer water pump	VOLVO	1 543 908-6		12017220	
114597	45,00	65,00	8,00	A/BS RD	ACM	114337	crankshaft	VOLVO	1 543 936		12017221	
112972	152,40	177,80	12,70	AS	NBR	112972	axle				12017268	
61261	45,00	60,00	8,00	AS W WD	ACM	61260	gearbox	VW	018 409 399	063665	12017270	
94772	23,00	35,00	8,00	BS RD	FPM	94771	gearbox	OPEL	714 409		12017271	
82176	100,00	135,00	13/15	SP	NBR	81333	wheel hub	ROR	212 201 58		12017274	
84397	140,00	160,00	13,00	C	NBR	93856	crankshaft	SAF	4 373 0010 00		12017296	
117851	48,00	65,00	16,50	SP	FPM	117851	crankshaft	New Holland	85821287		12017310	
119110	114,10	152/159,30	14,00	KA	FPM	111390	crankshaft	IVECO	4010 2320		12017353	
111377	114,10	152/159,30	14,00	KA	FPM	111390	crankshaft	IVECO	4010 2321		12017353	
114856	179,00	200,00	15,5/16,5	KA	FPM	114855	wheel hub	IVECO	4010 2940	456130	12017354	
118924	179,00	200,00	15,5/16,5	KA	FPM	114855	wheel hub	IVECO	4010 2943	456130	12017354	
94317	110,00	130,00	12,00	AS	NBR	19879	crankshaft	VOLVO	968 013-3		12017368	
97912	21,40	40,00	7,30	B RD	ACM	97911	crankshaft	FORD	1 075 731		12017369	
97901	35,00	54,00	10/15	AW/BS WD SF	ACM	97900	front axle	OPEL	374 197		12017376	
94318	100,00	120,00	12,00	A/BS WD	FPM	95865	crankshaft	VOLVO	1 070 379		12017395	
82497	158,00	188,00	14,5/18	KA	FPM	109377	crankshaft	SCANIA	1 363 674	919888	12017426	
111789	31,00	41,00	7,00	A/BS RD	FPM	111788	crankshaft	FIAT	762 8850	069590	12018321	81-35882-00
94547	40,00	52,00	7/6	A/BS	NBR	94546	wheel hub	VW	8A0 501 641 A		12018360	
96384	27,00	42,00	8,00	A/BS RD	FPM	96387	camshaft	VW	036 103 085 A	076110	12018554	81-34226-00
95233	73,02	101,60	15,87	SP	HNBR	95455	wheel hub	MF	3699800M2		12018598	
95649	84,93	104,77	18,26	SP1 RD	FPM/ACM	112634	crankshaft	SCANIA	1 383 129		12018653	
98061	84,93	104,77	18,26	SP1 RD	FPM/ACM	112634	crankshaft	SCANIA	1 386 594	222630	12018653	

dph-no	dim 1	dim 2	dim 3	Style	Material	dph oil seal no.	Application	Type	OEM-NO	Elring	Corteco	Reinz
112585	84,93	104,77	18,26	SP1 RD	FPM/ACM	112634	crankshaft	SCANIA	1 502 385	222630	12018653	
98060	84,93	104,77	12/18,26	SP2 LD	FPM/ACM	112636	front axle	SCANIA	1 393 331	222640	12018654	
111330	84,93	104,77	12/18,26	SP2 LD	FPM/ACM	112636	crankshaft	SCANIA	1 502 384	222640	12018654	
96450	23,00	35,00	9,00	CS RD	FPM	111539	gearbox	OPEL	714 413		12018671	
109072	28,00	42,00	5,00	AS RD	FPM	109071	camshaft	RENAULT	77 01 471 376	073890	12018754	81-34408-00
115529	42,00	54,00	6,00	AS RD	FPM/ACM	112276	crankshaft	OPEL	440 2706	157200	12018755	81-34413-00
112260	42,00	54,00	6,00	AS RD	FPM/ACM	112276	crankshaft	RENAULT	77 00 103 245	157200	12018755	81-34413-00
97431	52,00	68,00	8,00	A/BS RD	FPM	96995	gearbox	DB	015 997 0647	141960	12018806	
97423	52,00	68,00	8,00	A/BS RD	FPM	96995		DB	015 997 1647	141960	12018806	
112950	52,00	68,00	8,00	A/BS RD	FPM	96995	crankshaft	ZF	0734 310 104		12018806	
114875	75,00	100,00	11,00	AW/BS blue	NBR	114874	wheel hub	DB	019 997 5847	457120	12018888	
114444	117,48	152,36	22,00	SP KA	NBR	113977	wheel hub	IVECO	247 5977		12018944	
93390	117,48	152,36	22,00	KA	NBR	113977	axe	ROR	212 003 21		12018944	
113978	117,48	152,36	22,00	KA	NBR	113977	crankshaft	RVI	5010 368 901		12018944	
81330	117,48	152,36	22,00	KA	NBR	113977	STEMCO 2110	VOLVO	247 597		12018944	
3897	40,00	52,00	7,00	A	NBR	18068	wheel hub	PEUGEOT	3724 12	321508	12019046	
109581	105,00	125,00	13,00	A/BS LD	ACM	109580	crankshaft	DEUTZ	417 5433	746310	12019078	81-31440-00
113843	139,00	170,00	11,00	B LA SP	FPM	113842	crankshaft	MAN	81 96503 0445	517130	12019163	
114710	60,00	80,00	8/19	SP	FPM	114363	gearbox	DB	020 997 1347		12019242	
114709	60,00	80,00	7,00	A W	FPM	114362	gearbox	DB	020 997 1247		12019243	
117667	180,00	200,00	13,50	KA	NBR	117705	crankshaft	IVECO	4212 7773		12019601	
119000	136,80	165,00	13,00	KA	NBR	115632	crankshaft	DEUTZ	439 3239		12019619	
115634	136,80	165,00	13,00	KA	NBR	115632	crankshaft	ZF	0734 309 291		12019619	
119001	136,80	165,00	13,00	KA	NBR	115632	crankshaft	ZF	0734 309 422		12019619	
113951	110,00	130,00	12,00	A/BS W blue	NBR	113950	wheel hub	DB	011 997 5847		12019646	
111752	56,00	72,00	8,00	A/BS RD	FPM	111751		DB	019 997 0547	220900	12019647	
112762	56,00	72,00	8,00	A/BS RD	FPM	111751	transfer gearbox	DB	019 997 0647	220900	12019647	
113827	139,00	175/205,00	11/16,30	SP	FPM	113828	wheel hub	MAN	81 96503 6000	457300	12019683	
115094	130,00	170,00	18/20	KA	FPM	114448	crankshaft	DB	013 997 5946		12019945	
114501	130,00	170,00	18/20	KA	FPM	114448	crankshaft	SCANIA	1 415 136		12019945	
114502	130,00	170,00	18/20	KA	FPM	114448	crankshaft	ZF	0734 319 610		12019945	
111280	132,00	160,00	10,00	B WD	FPM	111357	crankshaft	MAN	06 56289 0387	485890	12020156	
96174	135,00	175,00	18,00	KA/BS SP	FPM/NBR	96648	wheel hub	MAN	81 96503 0188	009310	12020157	
98697	135,00	175,00	18,00	KA/BS SP	FPM/NBR	96648	wheel hub	MAN	81 96503 0398		12020157	
113846	87,26	120,76	15,40	KA SP	FPM/ACM	113845	crankshaft	MAN	81 96503 0161		12020256	

dph-no	dim 1	dim 2	dim 3	Style	Material	dph oil seal no.	Application	Type	OEM-NO	Elring	Corteco	Reinz
112266	142,00	170,00	15/16	KA	NBR	112790	wheel hub	SCANIA	1 409 889	222620	12020496	
114498	100,00	130,00	12,50	AW/BS SP	FPM	114441	wheel hub	RVI	5010 443 187		12033886	
111376	80,00	110/115,00	10/13	KA	FPM	111389	crankshaft	IVECO	4010 2301		12033893	
113835	105,00	140,00	18,00	KA SP	FPM	113833	wheel hub	MAN	81 96503 0171		12040000	
37641	42,00	56,00	7,00	AS RD W	MVQ	37639	camshaft	FORD	1 614 994		15011250	81-51109-20
81088	42,00	56,00	7,00	AS RD W	MVQ	37639	camshaft	FORD	6 078 801		15011250	81-51109-20
109059	79,38	95,25	11,00	AW BS LD	MVQ	80680	crankshaft	FORD	1 472 927	763713	15011263	
93703	79,38	95,25	11,00	AW/BS LD	MVQ	80680	crankshaft	FORD	1 614 763	763713	15011263	
93704	79,38	95,25	11,00	AW/BS LD	MVQ	80680	crankshaft	FORD	1 614 764	763713	15011263	
96239	88,00	108,00	11,10	AW/BS LD	MVQ	80679	crankshaft	FORD	1 614 996		15011269	
81087	88,00	108,00	11,10	AW BS LD	MVQ	80679	crankshaft	FORD	6 126 179	750476	15011269	
93623	36,51	52,48	8,00	AS W	MVQ	80634	crankshaft	FORD	1 614 762	586730	15012245	81-23056-00
80630	36,51	52,48	8,00	AS W	MVQ	80634	crankshaft	FORD	6 139 049	586730	15012245	81-23056-00
4480	52,00	68,00	10,00	AS RD W	MVQ	16052	crankshaft	VOLVO	1 276 425	465194	15012624	
33553	52,00	68,00	10,00	AS RD W	MVQ	16052	crankshaft	VOLVO PC	1 276 424	465194	15012624	81-25587-00
114683	52,00	68,00	10,00	AS RD W	MVQ	16052	crankshaft	VOLVO PC	430 132		15012624	
120107	45,00	60,00	8,00	AS RD	FPM	120108		Ferrari	133628		15014894	
97925	47,60	66,70	11,30	AS W RD	AEM/PTFE	111282	crankshaft	FORD	1 087 567	516406	15015977	
108806	44,45	57,15	6,75	AS RD	FPM	108806	crankshaft	VOLVO PC	6 842 272	135180	15018287	81-33634-00
119409	90,00	110,00	11,00	AS W RD	PTFE/ACM	119416	crankshaft	RENAULT	50 10 359 806	453930	15026914	81-37914-00
111452	145,00	175,00	13,00	AS LD SF	PTFE	111451	crankshaft	SCANIA	1 375 002	090510	15026917	81-35996-00
111453	145,00	175,00	13,00	AS LD SF	PTFE	111451	crankshaft	SCANIA	1 433 183	090510	15026917	81-35996-00
114620	100,00	124,00	12,00	AS RD SP	PTFE/ACM	114410	crankshaft	DAF	1340 321	493330	15027586	81-29052-10
113044	66,00	90,00	12,00	SP	PTFE	114371	crankshaft	MAN	51 01510 0219	061680	15027677	81-27522-10
94989	30,00	54,00	15/19,30	AS LD SP	FPM	113724	camshaft	VOLVO PC	3 507 309	393880	15029743	81-35989-00
109036	88,00	108,00	11,10	AW/BS LD	FPM	80639	crankshaft	FORD	1 663 815		15510078	
96246	35,00	50,00	7,00	A/B RD	FPM	50167	crankshaft	FORD	1 663 814		15510079	
114049	33,00	47,00	5,00	AS W RD	FPM	114098	crankshaft	FORD	1 112 945	023590	15510081	
95574	97,00	110,00	8,00	A LD felt	FPM	113718	crankshaft	VOLVO PC	9 458 178	135190	15510087	
4074	72,00	85,60	18,00	B blue	NBR	70313	front axle	DB	005 997 1646	009360	16011841	
15261	72,00	84/85,6	18,00	BS	NBR	48057	rear axle	DB	011 997 0646	018813	16011841	
115733	35,00	50,00	8,00	A RD	ACM	3900	camshaft	Mitsubishi	MD 008762	293946	19015083	
120086	80,00	100,00	8,50	AS LD	MVQ	120087	crankshaft	Toyota	90311-80007		19015091	81-53319-00
113900	48,00	65,00	8,00	SP	NBR	113899	crankshaft	MAZDA	B-216-26-154		19016502	
46886	42,00	65,00	12,00	AS 15 Grad	ACM	37404	differential	DB	000 997 5146	706035	19016590	

dph-no	dim 1	dim 2	dim 3	Style	Material	dph oil seal no.	Application	Type	OEM-NO	Elring	Corteco	Reinz
96923	75,50	108,00	10/19,5	SPT4A29	NBR	96922	wheel hub	Toyota	90311-75003		19016652	
120456	50,00	68,00	8,50	A SP	NBR	81051	wheel hub	Toyota	903115005		19017041	
96929	88,00	105,00	13,00	CS	NBR	96928	wheel hub	Toyota	90311-88102		19018295	
96927	40,00	46,00	12,8/17,5	SPSC5	NBR	96926	wheel hub	Toyota	90310-40001		19018296	
95097	125,00	150,00	15/13	A/BS WD	FPM	95098		DB	016 997 7747	457620	19020065	81-35109-00
119030	18,50	42,00	3,60	A OF	NBR	119029		FORD	FOCC3D527AA		19025707	
114500	149,90	176,00	16,00	KA	NBR	104925	wheel hub	SCANIA	1 342 708		19026423	
115421	75,50	107,00	8,00	AS W LD	FPM	115437	crankshaft	BMW	11 14 7 790 960		19026734	
96933	41,00	47,00	17,00	SPSC5	NBR	96932	wheel hub	Toyota	90310-41001		19026768	
119288	30,00	40,00	7,00	AS W LD	FPM	112608	crankshaft	Rover	LUC100290		19027629	
109114	80,00	100,00	13,00	A/BS W LD	MVQ	37509	crankshaft back	BMW	11 14 1 255 015	128210	19030094	81-18304-00
33549	80,00	100,00	13,00	A/BS LD W	MVQ	37509	crankshaft	VOLVO PC	1 218 027		19030094	81-18304-00
83884	80,00	100,00	13,00	A/BS W LD	MVQ	37509	crankshaft	VOLVO PC	3 267 244-6		19030094	
94835	114,00	142/170	14/27	B SP	NBR	94834	wheel hub	DAF	0190 069		19031938	
114868	145,00	165,00	13,00	A/BS blue	NBR	114867	wheel hub	DB	019 997 9047		19032103	
114584	40,00	63,00	8,70	A SP	FPM	113721	automatic gearbox	VOLVO PC	6 843 112		19033885	
115420	38,00	50,00	6,20	AS RD	FPM	115436	crankshaft	BMW	11 14 7 790 962	135140	19033909	
116813	35,00	55,00	8/14	HTB5Y	NBR	118408	differential	OPEL	374 594		19033952	
95604	50,00	68,00	9,00	AS RD FILZ	FPM	95621	crankshaft	OPEL	614 835		19033958	
94783	35,00	54,00	13,00	AS RD SP	ACM	94782	crankshaft	OPEL	374 227		19033964	
116814	35,00	73,00	8/14	HTB5Y	NBR	118409	differential	OPEL	374 595		19033965	
97873	50,00	68,00	7/10,5	SP	FPM	97872	crankshaft	OPEL	614 800		19033966	
118515	178,00	205,00	17,00	SP	NBR	118515		New Holland	9967701		19034568	
117755	100,00	130,00	17,00	CA	NBR	117760	wheel hub	DAF	1700 329		19034569	
116554	90,00	130,00	17,00	KA	NBR	113051		DAF	1404 690		19034570	
82480	80,00	100,00	13,00	A/BS W LD	MVQ	37509	crankshaft	RENAULT	77 03 087 080	128210	19930094	
37462	35,00	48,00	7,00	AS RD	MVQ	36781	crankshaft	OPEL	636 838		20011244	
80070	35,00	48,00	7,00	AS RD	MVQ	36781	crankshaft	OPEL	636 841	702269	20011244	81-24909-10
117108	90,00	110,00	7,00	AS W LD	FPM/ACM	117108	crankshaft	PEUGEOT	0127 28	508209	20015455	81-25925-00
109055	42,00	62,00	7,00	AS W RD	FPM/ACM	109055	camshaft	PEUGEOT	032 612	508233	20015456	
109075	36,00	50,00	7,00	AS W RD	FPM	109074	camshaft	PEUGEOT	0236 44	505366	20015457	81-34403-00
114557	29,85	47,00	11,30	combi	ACM	95498		CITROEN	3121.26	128240	20015497	
109151	29,85	47,00	11,30	combi	ACM	95498		CITROEN	9608 0792		20015497	
98169	29,85	47,00	11,30	combi	ACM	95498	differential	PEUGEOT	3121 26	128240	20015497	
115417	22,00	45,00	7,00	AS W LD	FPM	112607	camshaft	RENAULT	77 03 087 191	508608	20015738	81-26392-10

dph-no	dim 1	dim 2	dim 3	Style	Material	dph oil seal no.	Application	Type	OEM-NO	Elring	Corteco	Reinz
117340	48,00	65,00	10,00	AS W RD	AEM/PTFE	114341	crankshaft	MAN	81 96502 0934		20016209	
117341	48,00	65,00	10,00	AS W RD	AEM/PTFE	114341	gearbox	RVI	5000 819 719		20016209	
113767	48,00	65,00	10,00	AW/BS RD	FPM	36203	gearbox	ZF	0750 111 149		20016209	
113972	140,00	160,00	13,00	AS W WD blue	NBR	113971	wheel hub	RVI	5000 654 396		20016681	
113974	140,00	160,00	13,00	AS W WD blue	NBR	113971	wheel hub	RVI	5001 858 475		20016681	
47500	70,00	81,50	6,00	AW V	NBR	48009	front axle	DB	002 997 6547	331163	20016779	
47508	70,00	81,50	6,00	AW V	NBR	48009	front axle	DB	002 997 8847	331163	20016779	
113666	90,00	110,00	13,00	AS W	FPM	113665	crankshaft	MAN	06 56289 0183	514950	20016781	
47517	118,00	140,00	13,00	B	NBR	47041	wheel hub	DB	003 997 2347		20016791	
111646	120,00	140,00	13,5/15,5	AS WD W SF	FPM/ACM	113975	wheel hub	RVI	5003 087 034		20016794	
70447	136,52	161,92	12,70	A	NBR	24777	rear axle	SCANIA	121 257		20016795	
47421	72,00	84/85,6	18,00	BS	NBR	48057	rear axle	DB	603 997 0346		20017102	
111285	80,00	100,00	13,00	AS SP	PTFE	111403	crankshaft	SCANIA	369 477	382100	20017234	81-25013-30
111272	130,00	160,00	13,00	SP	PTFE	111404	crankshaft	SCANIA	369 478	354390	20017235	81-25014-20
84462	85,00	105,00	8,00	ASW LD	FPM/ACM	112606	crankshaft	PEUGEOT	0514 74	135110	20018066	81-23708-50
93435	42,00	66,00	6,00	BS W RD	FPM/ACM	93433	crankshaft	PEUGEOT	0514 72	505740	20018081	81-31863-00
115457	35,00	50,00	7,00	A/B RD	FPM	50167	crankshaft	PEUGEOT	0807 14	757292	20018100	81-25451-10
115353	85,00	105,00	11/6,8	AS LD	FPM	115352	crankshaft	RENAULT	77 03 087 224	711720	20018246	81-34417-00
109077	38,00	50,00	6,00	AS RD	FPM	109076	camshaft	PEUGEOT	0807 24	135140	20018317	81-34146-00
80493	50,00	65,00	8,00	B WD	FPM	80492	rear axle	VOLVO	1 522 373	597015	20019176	81-35124-00
114778	90,00	110,00	12,00	AS WD combi	PTFE/AEM	114405	crankshaft	BMW	11 14 2 247 164		20019546	
114779	90,00	110,00	12,00	AS WD combi	PTFE/AEM	114405	crankshaft	OPEL	614 802		20019546	81-20745-50
110581	90,00	110,00	12,00	AS W LD	PTFE/AEM	114405	crankshaft	OPEL	614 838		20019546	
114591	44,00	60,00	10,00	combi	PTFE	114335	crankshaft	BMW	11 14 1 435 848		20019548	81-28498-10
96714	44,00	60,00	10,00	combi	PTFE	114335	crankshaft	BMW	11 14 1 439 570	214680	20019548	81-28498-10
114670	48,00	65,00	10,00	AS W RD	AEM/PTFE	114341	crankshaft	BMW	11 14 2 247 117	050260	20019549	
96713	48,00	65,00	10,00	AS W RD	AEM/PTFE	114341	crankshaft	BMW	11 14 2 249 532	050260	20019549	81-17404-10
114341	30,00	40,00	7,00	AS RD W	PTFE/AEM	114341	crankshaft	OPEL	646 260		20019549	
115410	30,00	42,00	7,00	AS RD	FPM	51727	manual transmission	RENAULT	77 00 101 348	365940	20019850	
115774	35,00	47,00	6,00	AS RD	FPM	113719	crankshaft	RENAULT	77 00 273 776		20019851	81-15855-40
35053	75,00	95,00	10,00	AW LD	FPM/ACM	95002	crankshaft	VW	029 105 245 B	326798	20019852	
113602	32,00	42,00	8,00	AS RD W	FPM	113932	camshaft	VW	036 103 085 C		20019960	
109070	32,00	42,00	8,00	AS RD W	FPM	113932	camshaft	VW	036 103 085 H	158060	20019960	
98170	40,00	58,00	10,00	A W WD	FPM/ACM	117114	rear axle	PEUGEOT	3121 44	504581	20020137	81-38026-00
110504	85,00	131/152	15,70	KA	PTFE	120201	crankshaft	VW	06A 103 171 B / D	012370	20020383	81-90010-00

dph-no	dim 1	dim 2	dim 3	Style	Material	dph oil seal no.	Application	Type	OEM-NO	Elring	Corteco	Reinz
112374	68,00	85,00	10,50	AS W RD	FPM/ACM	80375	BF6L913, BF6L912	DEUTZ	423 2266	033459	20020386	81-21527-30
112514	115,00	140,00	13,50	AS LD	FPM/ACM	115617	crankshaft	DEUTZ	423 2267	033377	20020387	81-20481-30
97379	42,00	55,00	7,00	AS W RD	FPM/ACM	97538	FPM/ACM crankshaft	OPEL	638 199	127610	20020389	81-33489-00
97663	125,00	150,00	10,00	A/B W RD	FPM/ACM	97662	crankshaft	ZF	0734 310 165		20020422	
47684	30,00	40,00	7,00	AS RD W	FPM	47982	camshaft	DB	010 997 6147	589993	20020461	
93722	55,00	72,00	10,00	AW/BS RD	FPM	93721	crankshaft	BMW	11 14 1 713 722	818364	20020462	
116111	55,00	72,00	10,00	AW/BS RD	FPM	93721	crankshaft	BMW	11 14 1 725 994	818364	20020462	
37452	28,00	40,00	7,00	A RD W	FPM	37451	camshaft	BMW	11 14 1 271 415	562939	20020463	81-19159-10
116115	45,00	65,00	10,00	AW BS RD	FPM	95149	rear axle	BMW	33 12 1 202 121	216046	20020503	
114649	133,00	160,00	15,00	AS W LD	FPM	114419	crankshaft	DEUTZ	1215 2280		20020505	81-23364-00
47268	65,00	80,00	8/5,20	B	FPM	47954	crankshaft	DB	007 997 7946	493902	20020508	
113041	78,00	104,00	11,00	AW/BS RD	PTFE	114391	crankshaft	DB	022 997 7647	445591	20025510	81-36198-00
48936	26,00	43,00	7,00	A W RD	FPM	48935	crankshaft	VOLVO PC	1 218 239		20025648	
115503	48,00	66,65	8,00	AW/BS RD	FPM	98046	crankshaft	SAAB	91 73 576		20026265	
109979	40,00	62,00	8,00	AS LD SP	PTFE	109978	crankshaft	DB	166 997 0246	745750	20026275	81-35035-00
112638	100,00	125,00	13,00	A/B LD	FPM	112637	crankshaft back	BMW	11 14 1 710 247	818399	20026342	
114622	100,00	125,00	13,00	A/B LD	FPM	112637	crankshaft back	BMW	11 14 1 713 730	818399	20026342	81-27373-00
112729	35,00	48,00	10,00	AS W SP	AEM/PTFE	111624	crankshaft	VW	038 103 085 E	155560	20026412	81-34366-00
98140	32,00	47,00	10,00	AS RD SP	PTFE/ACM	112807	crankshaft	VW	038 103 085 C	129780	20026413	
114602	45,00	67,00	8,00	ASW RD	PTFE	114339	crankshaft	DB	021 997 1847	424841	20026532	
114603	45,00	67,00	8,00	ASW RD	PTFE	114339	crankshaft	DB	023 997 8447	424841	20026532	
117122	40,00	54,00	6,80	A W LD	FPM	117121	differential	PEUGEOT	3121 40		20026877	
117123	40,00	54,00	6,80	A W LD	FPM	117121	differential	RENAULT	77 03 087 209		20026877	
117125	27,94	56,00	8,00	AS W RD	FPM	117124	differential	PEUGEOT	3121 42		20026878	
117126	27,94	56,00	8,00	AS W RD	FPM	117124	differential	RENAULT	77 03 087 210		20026878	
119407	150,00	172,00	13,00	AW LD W	PTFE/ACM	119414	crankshaft	RENAULT	50 10 359 807	457220	20026913	81-37933-00
47669	65,00	90,00	15,00	B RD	FPM	47957	crankshaft	DB	009 997 7747		20027937	
114058	27,00	47,00	7,00	AS W RD	ACM/PTFE	114095	camshaft	FORD	1 145 953	026740	20029115	81-35552-00
114056	40,00	55,00	6,40	AS W RD	ACM/PTFE	114093	crankshaft	FORD	1 142 359	026750	20029116	81-35554-00
114057	85,00	105,00	8,80	AS W LD	ACM/PTFE	114094	crankshaft	FORD	1 142 360	026790	20029117	81-35553-00
111400	110,00	130,00	13,00	A/BS LD	PTFE	109691	crankshaft	MAN	51 01510 0218	503208	20029606	81-33801-00
114051	30,00	50,00	7,50	AS W RD	ACM/PTFE	114096	crankshaft	FORD	1 198 045	026770	20029769	
97822	154,00	180,00	12,00	A/BS LD	AEM/PTFE	115386	crankshaft	DAF	1340 320	017590	20029771	81-28539-00
117251	154,00	180,00	12,00	A/BS LD	PTFE/AEM	115386	crankshaft	DAF	1370 127	175990	20029771	
114624	100,00	130,00	12,00	AW/BS RD	PTFE/ACM	114411	crankshaft	DB	021 997 5247	369900	20029784	

