



Growing the **HEAVY DUTY** After market

INTRODUCING FORMERLY "DEALER ONLY" PARTS



Coolant Tubes, Heating and Cooling

Tubos de refrigerante,
calefacción y refrigeración

page
04

Door Handles and Body Parts

Manijas de las puertas y
partes para la carrocería

page
10

Fluid Reservoirs and Engine Parts

Recipientes de líquido
y partes para el motor

page
20

Fuel Senders, Fuel and Emissions

Envíos de combustible,
combustible y emisiones

page
32

Headlights and Lighting

Faros
e iluminación

page
42

Hood Springs, Latches and Components

Resortes del capó, cierres y
componentes

page
46

Speed and Tachometer Sensors

Sensores de velocidad
y sensores de tacómetro

page
56

Window Regulators and Window Parts

Reguladores de ventana y
partes para la ventana

page
62

Wiper Transmissions and Dash Components

Transmisiones de
limpiaparabrisas y componentes
para el tablero de instrumentos

page
72

Coolant Tubes, Heating and Cooling

Pages 04-08



Door Handles and Body Parts

Pages 10-18



Fluid Reservoirs and Engine Parts

Pages 20-31



Fuel Senders, Fuel and Emissions

Pages 32-39



Headlights and Lighting

Pages 42-45



Hood Springs, Latches and Components

Pages 46-54



Speed Sensors and Tachometer Sensors

Pages 56-61



Window Regulators and Window Parts

Pages 62-71



Wiper Transmissions and Dash Components

Pages 72-74



table of contents

Coolant Tubes, Heating and Cooling
Tubos de refrigerante, calefacción y refrigeración

page 04

Door Handles and Body Parts
Manijas de la puerta y partes para la carrocería

page 10

Fluid Reservoirs and Engine Parts
Recipientes de líquido y partes para el motor

page 20

Fuel Senders, Fuel and Emissions
Envíos de combustible, combustible y emisiones

page 32

Headlights and Lighting
Luces delanteras e iluminación

page 42

Hood Springs, Latches and Components
Resortes del capó, cierres y componentes

page 46

Speed Sensors and Tachometer Sensors
Sensores de velocidad y sensores de tacómetro

page 56

Window Regulators and Window Parts
Reguladores de ventana y partes para la ventana

page 62

Wiper Transmissions and Dash Components
Transmisiones de limpiaparabrisas y componentes para el tablero de instrumentos

page 72

Alphabetical Interchange by Part Type
Intercambio alfabético por el tipo de pieza

page 76

OE to Dorman Interchange
De equipo original a Intercambio de Dorman

page 78

Interchange by Manufacturer
Intercambio de fabricante

page 80

Interchange by Dorman Number
Intercambio de equipo original

page 82

Coolant Tubes, Heating and Cooling

Tubos de refrigerante, calefacción y refrigeración

When you think about the environment in which a coolant tube operates, it's hard to believe they are made the way they are. You've seen these parts replaced over and over again. Coolant tubes fail early and often. Why? The parts are poorly designed!

You're sick of it, and so are we. So we decided to do something about it! Through the collection and examination of failed OE parts, our product team has been able to target the most failure prone coolant tubes, the ones you have to replace at an alarming rate. We've beefed up the weak spots. We've gotten rid of mild steel and replaced it with high-quality stainless. The result: a more reliable solution for you and your truck.

Los tubos del refrigerante transportan agua desde el radiador hasta el bloque del motor. Debido a esta proximidad con el motor, estas piezas son estresadas constantemente por las vibraciones y las altas temperaturas que existen bajo el capó del camión. El estrés de este entorno puede causar los tubos a corroer, mohorarse, romperse y fugas, resultando en las tasas de sustitución alto.

Los tubos refrigerantes reestructurados por Dorman están contruidos con un material actualizado de acero inoxidable. Esto ayuda a reducir la corrosión, resultando en una piezas de muy buena calidad y muy confiable.



OE NUMBERS CAN
TYPICALLY BE
FOUND STAMPED
ON THE ENDS OF
COOLANT TUBES



Coolant Tube

Dorman# 936-5201 **OE#** A05-16380-003

Make: Freightliner

Years: 2011-99

Models: Century Class, Argosy, Columbia

Notes: Detroit Diesel Series 60



Material Upgraded to Stainless Steel

Coolant Tube

Dorman# 936-5202 **OE#** A05-16384-001

Make: Freightliner

Years: 2011-90

Models: FLD, Century, Columbia

Notes: Caterpillar C15 3406E



Material Upgraded to Stainless Steel

Coolant Tube

Dorman# 936-5403 **OE#** K181-5141

Make: Kenworth

Years: 2011-90

Models: W900B, W900L

Notes: Caterpillar C15 3406E, & 3176



Material Upgraded to Stainless Steel

Coolant Tube

Dorman# 936-5404 **OE#** K181-5483

Make: Kenworth

Years: 2003-90

Models: T800, T600

Notes: Caterpillar C15 3406E, & Acert



Material Upgraded to Stainless Steel

Coolant Tubes, Heating and Cooling

Tubos de refrigerante, calefacción y refrigeración



Coolant Tube

Dorman# 936-5405 **OE#** K181-5597

Make: Kenworth

Years: 2011-95

Models: W900L, W900B

Notes: Caterpillar C15 3406E

Material Upgraded to Stainless Steel



Coolant Tube

Dorman# 936-5401 **OE#** 07-06464

Make: Peterbilt

Years: 2004-90

Models: 379, 378, 377, 357

Notes: Cummins N14

Material Upgraded to Stainless Steel



Coolant Tube

Dorman# 936-5402 **OE#** 07-06462

Make: Peterbilt

Years: 2005-87

Models: 379, 378, 377, 357

Notes: Caterpillar C15 3406E

Material Upgraded to Stainless Steel



Coolant Tube

Dorman# 936-5501 **OE#** 20561364

Make: Volvo

Years: 2008-01

Models: VN

Notes: Cummins & Volvo N14, D12

Material Upgraded
to Stainless Steel

Coolant Tube

Dorman# 936-5502 **OE#** 20357260

Make: Volvo

Years: 2011-00

Models: VN, VNL, VHD

Notes: Cummins & Volvo ISX, D12



Material Upgraded to Stainless Steel

Air Door Actuator

Dorman# 604-5101 **OE#** 3542606C1

Make: International

Years: 2009-03

Models: 4000, 7000,
8000, 9000, Prostar



Heater Hose Connector

Dorman# 800-401 **OE#** 15622861

Make: GMC

Years: 2002-30

Models: C3500, C4500, C5500

Notes: Heater hose inlet of $\frac{5}{8}$ and
thread size $\frac{1}{2}$ NPT



HVAC Knob Kit

Dorman# 702-5402 **OE#** FD1240

Make: Kenworth

Years: 2009-03

Models: T-Series, W-Series

Notes: Bergstrom HVAC system



Kit Includes Three Knobs

Coolant Tubes, Heating and Cooling

Tubos de refrigerante, calefacción y refrigeración



HVAC Knob Kit

Dorman# 702-5401 OE# 121-0001-000

Make: Peterbilt

Years: 2011-87

Models: 357, 367, 375, 378, 379, 386, 387, 330, 335

Notes: Sprague HVAC system

Kit Includes Three Knobs



Radiator Fan Assembly

Dorman# 620-5601 OE# 8-97383-808-0

Make: Isuzu

Years: 2010-94

Models: NPR



For Our Latest Parts
And Complete Applications



Also Available From **DORMAN**®

NYLON FUEL LINE REPAIR KIT 800-300



Over 99 Pieces

- Quick Fix For The Unexpected Repair
- Eliminates Need To Wait On Parts



GIVE CUSTOMERS A REPAIR ALTERNATIVE!

STEEL FUEL LINE REPAIR KIT 800-500



FREE TOOLS INCLUDED



Over 150 Pieces

- Fix The Fuel Line, Don't Replace It
- On The Vehicle Repair Saves Bay Time!
- No Waiting For Special Order OE Assemblies

Solutions to These Common Fuel Line Problems:



A/C LINE REPAIR KIT 800-600



NEW!

Over 60 Pieces

ON-THE-CAR REPAIR SOLUTION



Repairs:

Save Time and Money by Repairing **Only** the Damaged Section



Sealant



90 Degree Elbow Unions



Unions



High And Low Side Service Port Unions



Flexible Rubber Tubes



Rigid Tubes



Female External O-Ring Repair Ends



Male Internal O-Ring Repair Ends



Male External O-Ring Repair Ends



Compressing Clamp



BR Condenser Repair Lines Upper And Lower



Clamp Tubes

Door Handles and Body Parts

Manijas de las puertas y partes para la carrocería

When you consider the amount of wear and tear a door handle goes through in a typical day, it's no surprise why you replace them so often. They take a beating. Truckers pull themselves into the cab using the exterior handles to support their weight, and lean on the interior handles again on the way out of the truck. When you couple this level of wear and tear with constant exposure to the elements you are left with handles that are rusted, damaged and broken.

At Dorman we've focused on the door handles that give you the most problems. We've developed replacement parts for the handles that frequently fail and give you one headache after another. The handles you've sent to us, and asked us to develop an aftermarket alternative for! Dorman HD Solutions has the handles you need. We've got your alternative solution to the dealer.

Manijas de las puertas, se someten a un gran desgaste cada momento que es conducido por un camión. Hay una enorme cantidad de fuerza aplicada a la manija cuando entra y sale de la cabina. Este alto nivel de desgaste se combina con la constante exposición a los elementos y las razones por las cuales debilitan a los tiradores de las puertas aclarándose con el tiempo. Una vez se oxida y se corroe la manija mientras entra y sale de la cabina pueden causar daños e incluso romper la pieza.



OE NUMBERS
CAN TYPICALLY
BE FOUND ON
THE BACK OF
DOOR HANDLES



Handle, Exterior Front Right

Dorman# 760-5201 **OE#** A18-42228-003

Make: Freightliner

Years: 2011-00

Models: Columbia



Handle, Exterior Front Left

Dorman# 760-5202 **OE#** A18-42228-002

Make: Freightliner

Years: 2011-00

Models: Columbia



Handle, Exterior Front Left

Dorman# 760-5203 **OE#** A18-42228-000

Make: Freightliner

Years: 2011-96

Models: Condor



Handle, Exterior Front Right

Dorman# 760-5204 **OE#** A18-42228-001

Make: Freightliner

Years: 2011-96

Models: Condor



Door Handles and Body Parts

Manijas de las puertas y partes para la carrocería



Handle, Exterior Front Left

Dorman# 760-5205 OE# A18-35381-000

Make: Freightliner

Years: 2007-91

Models: Classic Cab, FLD



Handle, Exterior Front Right

Dorman# 760-5206 OE# A18-35381-001

Make: Freightliner

Years: 2007-91

Models: Classic Cab, FLD



Handle, Exterior Front Left/Right

Dorman# 760-5207(R) OE# (R) A18-53241-001,
760-5208(L) A18-47729-003

(L) A18-53241-000,
A18-47729-002

Make: Freightliner

Years: 2011-08

Models: Cascadia, Business M2, Business Class



Handle, Exterior Front Right

Dorman# 760-5603 OE# 15619625

Make: GMC

Years: 2003-95

Models: Topkick, Kodiak

Handle, Exterior Front Left

Dorman# 760-5604 **OE#** 15619624

Make: GMC

Years: 2003-95

Models: GMC Top Kick and Kodiack Truck



Handle, Exterior Front Right/Left

Dorman# 760-5101 **OE#** 3550931C91

Make: International

Years: 2008-97

Models: 2000, 3000, 4000, 7000,
8000, 9000 Series



Handle, Exterior Front Right

Dorman# 760-5105 **OE#** 2594006C1

Make: International

Years: 2011-08

Models: International Prostar



Handle, Exterior Front Left

Dorman# 760-5106 **OE#** 2594003C1

Make: International

Years: 2011-08

Models: International Prostar



Door Handles and Body Parts

Manijas de las puertas y partes para la carrocería



Handle, Exterior

Dorman# 760-5601(L) **OE#** 8-97867-721-1
760-5602(R) 8-97867-722-1

Make: Isuzu
Years: 2000-94
Models: NPR, NKR



Handle, Exterior Front Left/Right

Dorman# 760-5404(L) **OE#** K294-411PAK
760-5405(R) K294-411RPAK

Make: Kenworth
Years: 2001-95
Models: T-Series

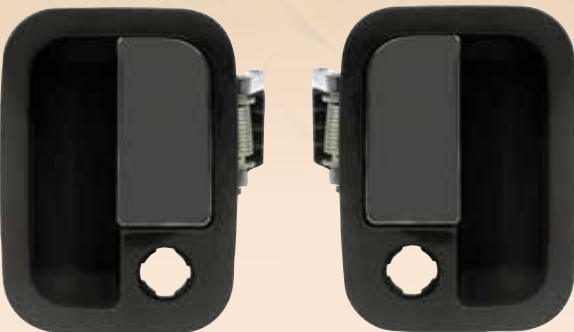

Handle, Exterior

Dorman# 760-5403(L) **OE#** R56-1025
760-5408(R) R56-1025R

Make: Kenworth
Years: 2011-01
Models: T270, T300 T370, T660
Note: Daylight Door



Handle, Exterior Front Right/Left

Dorman# 760-5501 **OE#** 25192012

Make: Mack
Years: 2007-95
Models: LE613

Handle, Exterior Front Right/Left

Dorman# 760-5502 **OE#** 25191926

Make: Mack

Years: 2005-90

Models: CH613

Note: Steel Door



Handle, Exterior Front Left

Dorman# 760-5401 **OE#** 20-08179L

Make: Peterbilt

Years: 2005-83

Models: 330, 335, 349, 357, 358, 359,
362, 365, 370, 372, 375, 376,
377, 378, 379, 400



Handle, Exterior Front Right

Dorman# 760-5402 **OE#** 20-08179R

Make: Peterbilt

Years: 2005-83

Models: 330, 335, 349, 357, 358, 359,
362, 365, 370, 372, 375, 376,
377, 378, 379, 400



Handle, Exterior

Dorman# 760-5403(L) **OE#** R56-1025
760-5408(R) R56-1025R

Make: Peterbilt

Years: 2011-01

Models: 325, 330, 357, 386,
387, 388, 389

Note: Daylight Door

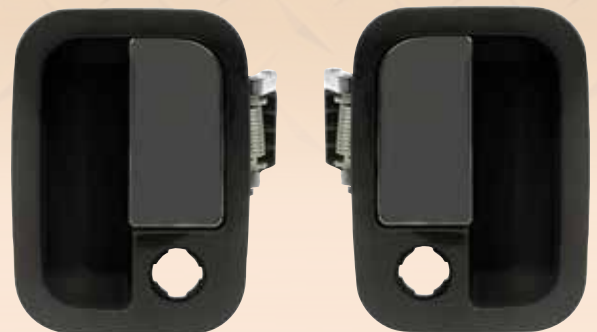

Door Handles and Body Parts

Manijas de las puertas y partes para la carrocería



Handle, Interior Front Right

Dorman# 761-5103 OE# 2505425C1

Make: International

Years: 2012-10

Models: Durastar



Handle, Interior Front Left

Dorman# 761-5104 OE# 2505424C1

Make: International

Years: 2012-10

Models: Durastar

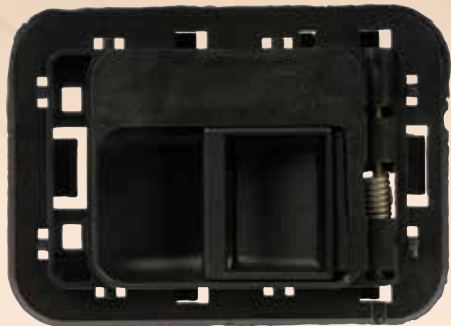

Handle, Interior Front Left

Dorman# 761-5406 OE# K294-426PAK

Make: Kenworth

Years: 2001-95

Models: T-Series and W-Series

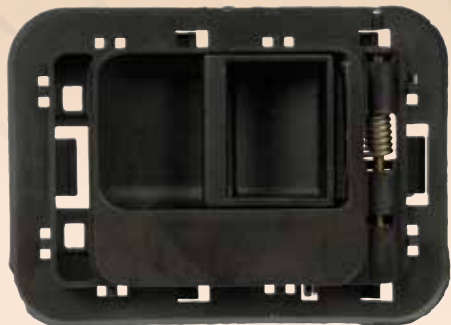

Handle, Interior Front Right

Dorman# 761-5407 OE# K294-426RPAK

Make: Kenworth

Years: 2001-95

Models: T-Series and W-Series

Brake Pedal Pad

Dorman# 20759 OE# 3920296

Make: GMC

Years: 1998-91

Models: Topkick, Kodiak



Door Check Kit

Dorman# 924-5401 OE# 20-11525M001

20-18727

R65-6019

20-12066

Make: Peterbilt

Years: 2005-87

Models: 357, 367, 375, 377, 378, 379



One Kit Includes Four Parts
The Dealer Only Offers Separately

Door Hinge

Dorman# 924-5103 OE# 3549259C1

Make: International

Years: 2011-02

Models: 4000, 7000, 8000, Lonestar,
Prostar, Terrastar, CXT, RXT, MXT



Door Hinge

Dorman# 924-5603 OE# 8-97852-007-3

Make: Isuzu

Years: 2000-94

Models: NPR



Door Handles and Body Parts

Manijas de las puertas y partes para la carrocería



Right Lower

Left Lower

Mirror Bracket

Dorman# 924-5105(LL) **OE#** 2597071C91
924-5106(RL) 2597075C91

Make: International

Years: 2012-02

Models: 3000, 4000, 7000 8000 Series,
Prostar, Lonestar, RXT, Terrastar



Mirror Motor

Dorman# 924-5204 **OE#** 28569

Make: Freightliner

Years: 2011-08

Models: Cascadia



Mirror Switch

Dorman# 901-5201 **OE#** 34103PF

Make: Freightliner

Years: 2009-03

Models: FLC, Century



Shift Boot

Dorman# 924-5405 **OE#** 2K042-79

Make: Kenworth

Years: 2011-99

Models: T-Series and W-Series

Notes: Square shift boot

SIGN UP NOW!

**BE THE FIRST
TO KNOW!**



ABOUT FORMERLY "DEALER ONLY" PARTS

- Sign up for The HD Solutions
Be the First to Know Program
- Get New Product Update Emails or Texts
 - Learn More About The Latest Formerly Dealer Only Parts



Fluid Reservoirs and Engine Parts

Recipientes de líquido y partes para el motor

You've all heard the horror stories. A truck is out of service because of a leaking fluid reservoir. You lose your patience, your temper and worst of all - your profit. These reservoirs are exposed to the harsh conditions that exist under the hood of your truck. Extreme temperatures and constant vibrations yield an endless struggle that these parts will ultimately lose.

By soliciting the help of technicians, Dorman has been able to leverage firsthand experience to identify the most in-demand fluid reservoirs. The coolant tanks and washer bottles that never seem to stay on your truck long enough. We've examined common failure patterns and redesigned our parts to reduce or eliminate these conditions. We've upgraded materials. We've eliminated leak prone areas.

Los depósitos de líquidos se encuentran normalmente cerca del motor del camión. Las temperaturas extremadamente altas y las fuertes vibraciones que caracterizan a este entorno contribuyen significativamente a fallas en los depósitos de líquidos. Cuando están expuestos a altas temperaturas durante un período prolongado de tiempo, las botellas pueden fundirse y deformarse, resultando en pérdidas. La presión adicional de las vibraciones del motor puede causar ciertos materiales quebrarse y romperse.

Los depósitos de líquidos también se reemplazan con frecuencia debido al desgaste de los lugares de montaje. Con el tiempo, las temperaturas extremas y las vibraciones del motor pueden debilitar el montaje hasta el punto de hacer grietas o romperlo, necesitando un reemplazo de embalse.



OE NUMBERS CAN TYPICALLY BE FOUND ON THE SURFACE OF FLUID RESERVOIR CAPS



OE NUMBERS CAN TYPICALLY BE FOUND PRINTED ON THE SIDE OF FLUID RESERVOIRS



Coolant Tank

Dorman# 603-5201 OE# 05-23045-000

Make: Freightliner

Years: 2009-04

Models: Century, Columbia, CL112, CL120



Coolant Tank

Dorman# 603-5202 OE# 05-23195-000

Make: Freightliner

Years: 2011-05

Models: M2 Business Class

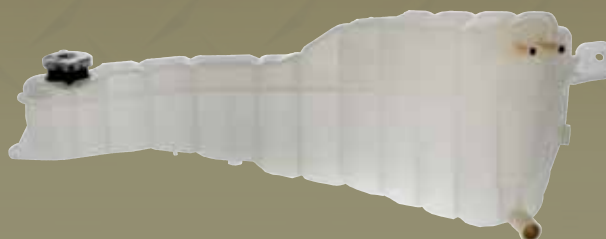

Coolant Tank

Dorman# 603-5601 OE# 15161670

Make: GMC

Years: 2008-03

Models: 6000, 7000, 8000, C4500,
C5500, Topkick and Kodiak



Coolant Tank

Dorman# 603-5101 OE# 2002105C3

Make: International

Years: 2007-02

Models: 2000 Series, 4000 Series



Fluid Reservoirs and Engine Parts

Recipientes de líquido y partes para el motor



Coolant Tank

Dorman# 603-5103 OE# 2508700C92

Make: International

Years: 2010-03

Models: 9000 Series

Notes: Improved Clear Design Eliminates Fluid Level Indicator Ports - Reducing Potential Leaks



Coolant Tank

Dorman# 603-5603 OE# 8972230122

Make: Isuzu

Years: 2010-96

Models: NPR, NQR, NRR

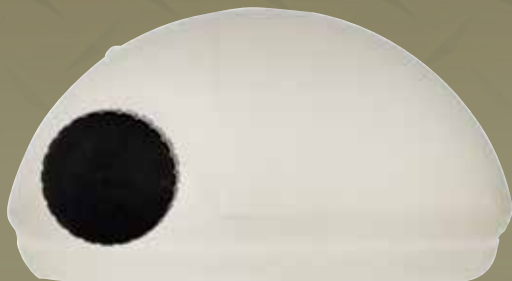

Coolant Tank

Dorman# 603-5501 OE# 25133601

Make: Mack

Years: 2008-04

Models: CV713



Coolant Tank

Dorman# 603-5502 OE# 25174629

Make: Mack

Years: 2008-04

Models: CV713

Coolant Tank

Dorman# 603-5403 OE# N5346001

Make: Peterbilt

Years: 2010-08

Models: 335, 337, 340, 348, 349, 352, 353,
357, 359, 362, 365, 367, 372, 375,
376, 377, 378, 379, 384, 385, 386,
387, 388, 389

Notes: Using a Cummins and Caterpillar
Engine With BEHR Cooling Module.



Washer Tank

Dorman# 603-5602 OE# 8978550656

Make: Isuzu

Years: 2010-96

Models: NPR, NQR, NRR

Notes: Improved Clear Design Eliminates
Fluid Level Indicator Ports -
Reducing Potential Leaks



Washer Tank

Dorman# 603-5401 OE# K114-20

Make: Kenworth

Years: 2002-99

Models: T Series, W900, C500,



Washer Tank

Dorman# 603-5503 OE# 25128217

Make: Mack

Years: 2010-05

Models: MR688S



Fluid Reservoirs and Engine Parts

Recipientes de líquido y partes para el motor



Washer Tank

Dorman# 603-5402 OE# N5355001

Make: Peterbilt

Years: 2010-08

Models: 335, 337, 340, 348, 349, 352, 353, 357, 359, 362, 365, 367, 372, 375, 376, 377, 378, 379, 384, 385, 386, 387, 388, 389

Notes: Using a Cummins and Caterpillar Engine With BEHR Cooling Module.



Washer Tank

Dorman# 603-5404 OE# R86-6001

Make: Peterbilt

Years: 2005-90

Models: 357, 367, 375, 377, 378, 379



Coolant Level Sensor

Dorman# 924-5205 OE# 06-62384-002

Make: Freightliner

Years: 2010-07

Models: Cascadia, Coronado, Columbia

Notes: Fits A05-25263-005 Coolant Bottle



Coolant Tank Cap

Dorman# 902-5201 OE# 05-20763-001

Make: Freightliner

Years: 2009-04

Models: Century, Columbia, CL112, CL120

Notes: Fits OEM Reservoir # 05-23045-000
Fits Dorman Reservoir # 603-5201

Coolant Tank Cap

Dorman# 902-5202 OE# 05-17223-002

Make: Freightliner

Years: 2011-05

Models: M2 Business Class

Notes: Fits OEM Reservoir # 05-23195-000
Fits Dorman Reservoir # 603-5202



Coolant Tank Cap

Dorman# 902-5601 OE# 15075118

Make: GMC

Years: 2008-03

Models: 6000, 7000, 8000, C4500,
C5500 Topkick and Kodiak

Notes: Fits OEM Reservoir # 15161670
Fits Dorman Reservoir # 603-5601



Coolant Tank Cap

Dorman# 902-5101 OE# 2039390C3

Make: International

Years: 2007-02

Models: 2000 Series, 4000 Series

Notes: Fits OEM Reservoir # 2002105C3
Fits Dorman Reservoir # 603-5101



Coolant Tank Cap

Dorman# 902-5102 OE# 3578833C3

Make: International

Years: 2010-03

Models: 9000 Series

Notes: Fits OEM Reservoir # 2508700C92
Fits Dorman Reservoir # 603-5103



Fluid Reservoirs and Engine Parts

Recipientes de líquido y partes para el motor

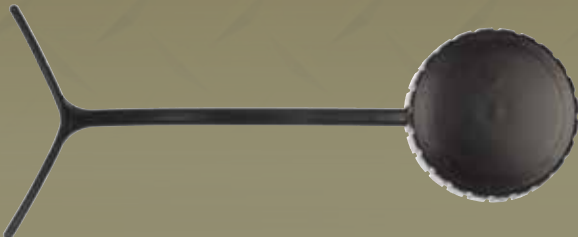

Coolant Tank Cap

Dorman# 902-5404 OE# 3150-063415A

Make: Mack

Years: 2008-04

Models: CV713

Notes: Fits OEM Reservoir # 25133601
Fits Dorman Reservoir # 603-5501



Coolant Tank Cap

Dorman# 902-5502 OE# 5481-9916238

Make: Mack

Years: 2008-04

Models: CV713

Notes: Fits OEM Reservoir # 25174629
Fits Dorman Reservoir # 603-5502



Coolant Tank Cap

Dorman# 902-5402 OE# N5348001

Make: Peterbilt

Years: 2010-08

Models: 335, 337, 340, 348, 349, 352, 353, 357, 359, 362, 365, 367, 372, 375, 376, 377, 378, 379, 384, 385, 386, 387, 388, 389

Notes: Fits OEM Reservoir # N5346001
Fits Dorman Reservoir # 603-5403



Coolant Tank Cap

Dorman# 902-5403 OE# RC0050

Make: Peterbilt

Years: 2010-08

Models: 335, 337, 340, 348, 349, 352, 353, 357, 359, 362, 365, 367, 372, 375, 376, 377, 378, 379, 384, 385, 386, 387, 388, 389

Notes: Fits OEM Reservoir # N5346001
Fits Dorman Reservoir # 603-5403

Washer Tank Cap

Dorman# 902-5404 OE# FLM-063361

Make: Freightliner

Years: 2000-93

Models: FLD Class

Notes: Fits OEM Reservoir # FLM065400



Washer Tank Cap

Dorman# 902-5401 OE# C5720S

Make: Kenworth

Years: 2002-99

Models: T Series, W900, C500,

Notes: Fits OEM Reservoir # K114-20
Fits Dorman Reservoir # 603-5401



Washer Tank Cap

Dorman# 902-5401 OE# 25171612

Make: Mack

Years: 2004-02

Models: MR688S

Notes: Fits OEM Reservoir # 25128217
Fits Dorman Reservoir # 603-5503



Washer Tank Cap

Dorman# 902-5401 OE# Not Sold Separately

Make: Peterbilt

Years: 2010-08

Models: 335, 337, 340, 348, 349, 352, 353, 357,
359, 362, 365, 367, 372, 375, 376, 377,
378, 379, 384, 385, 386, 387, 388, 389

Notes: Fits OEM Reservoir # N5355001
Fits Dorman Reservoir # 603-5402



Fluid Reservoirs and Engine Parts

Recipientes de líquido y partes para el motor



Washer Tank Cap

Dorman# 902-5404 OE# 63361

Make: Peterbilt

Years: 2005-90

Models: 357 362 365 372 375

Notes: Fits OEM Reservoir # R86-6001
Fits Dorman Reservoir # 603-5404



Oil Cooler Line

Dorman# 625-250 OE# F5HZ6A715AA

Make: Ford

Years: 1998-95

Models: F700; V8 - 7.0L (429 CID)



Oil Cooler Line

Dorman# 625-251 OE# F5HZ6A715BA

Make: Ford

Years: 1998-95

Models: F700; V8 - 7.0L (429 CID)



Oil Cooler Line

Dorman# 625-185 OE# 15791673

Make: GMC

Years: 2008-03

Models: C4500, C5500; V8 - 8.1L (496 CID)

Oil Cooler Line

Dorman# 625-187 OE# 15791675

Make: GMC

Years: 2008-03

Models: C4500/C5500; V8 - 8.1L (496 CID)



Oil Cooler Line

Dorman# 625-188 OE# 93440852

Make: GMC

Years: 2002-01

Models: C6500/C7500, School Bus;
V8 - 8.1L (496 CID)



Oil Cooler Line

Dorman# 625-189 OE# 93440853

Make: GMC

Years: 2002-01

Models: C6500/C7500, School Bus;
V8 - 8.1L (496 CID)



Oil Cooler Line

Dorman# 625-190 OE# 15022583

Make: GMC

Years: 2000-98

Models: C6500/C7500, 2000-99, School Bus;
V8 - 7.4L (454 CID)



Fluid Reservoirs and Engine Parts

Recipientes de líquido y partes para el motor

Oil Cooler Line

Dorman# 625-191 OE# 15149877

Make: GMC

Years: 1998-97

Models: C6500/C7500,
V8 - 6.0L (366 CID); C6500/
C7500, V8 - 7.4L (454 CID);
C6500/C7500, V8- 7.0L (427 CID)



Oil Cooler Line

Dorman# 625-192 OE# 15022583

Make: GMC

Years: 1998-97

Models: C6500/C7500,
V8 - 6.0L (366 CID);
C6500/C7500, V8- 7.0L (427 CID)



Oil Cooler Line

Dorman# 625-195 OE# 15706746

Make: GMC

Years: 2000-99

Models: C6500/C7500, School Bus, V8-7.4L;
School Bus, V8-6.0L & V8-7.0L;
C6500/C7500, V8-6.0L & V8-7.0L;
Delivery Truck, V8-6.0L & V8-7.0L



Oil Cooler Line

Dorman# 625-196 OE# 15706745

Make: GMC

Years: 2000-96

Models: C6500/C7500, V8-7.4L; School Bus,
V8-6.0L & V8-7.0L; C6500/C7500,
V8-6.0L & V8-7.0L; Delivery Truck,
V8-6.0L & V8-7.0L



Oil Cooler Line

Dorman# 625-193 OE# 15149878

Make: GMC

Years: 1998-97

Models: C6500/C7500;
V8 - 6.0L (366 CID),
V8- 7.0L (427 CID)



Oil Cooler Line

Dorman# 625-194 OE# 15028506

Make: GMC

Years: 1998-97

Models: C6500/C7500; V8 - 6.0L (366
CID), V8- 7.0L (427 CID)

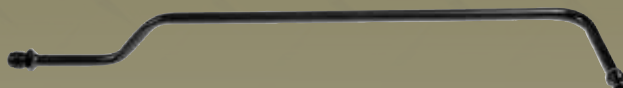

Oil Cooler Line Connector

Dorman# 800-707 OE# 15170197
15797464

Make: GMC

Years: 2007-03

Models: C3500, C4500, C5500

Notes: Transmission cooler line to radiator



Power Steering Pump Pulley

Dorman# 300-120 OE# 2477954

Make: GMC

Years: 2000-81

Models: Chevrolet/GMC Truck; 2000-83
School Bus, Steel Conventional; 96-
81 Topkick, Kodiak, forward control



Fuel Senders, Fuel and Emissions

Envíos de combustible, combustible y emisiones

You hear about it every day. It's the same old story. The cost of fuel is rising and proper fuel management is becoming more important than ever. You more than likely take the appropriate steps to make sure that you are conserving as much fuel as possible. You go to extreme lengths to make sure you aren't wasting money. Nothing could be worse than going to these lengths only to find out that your fuel sender isn't displaying an accurate fuel level.

In researching the Dorman HD Solutions fuel senders, our product team reached out to technicians and repair shops in an effort to develop comprehensive solutions to common problems associated with faulty fuel senders. As a result, we provide a complete offering of part alternatives to failure prone fuel level senders. These senders are sold as a kit and each includes the gasket needed for a complete repair. This comprehensive solution helps you to cut down on product cost and repair time.

Los remitentes de combustible se encuentran dentro del tanque de combustible y constantemente están sumergidos en el combustible. Con el tiempo, la exposición a este entorno puede causar daños a las unidades. El combustible puede hacerse gelatina (gel) y se adhieren a distintas zonas del remitente, causando lecturas inexactas o un brazo de nivel incautado. También, los aditivos del combustible pueden ser desgastados fuera del material del remitente, causando patrones similares de fracaso.

Como el costo del combustible sigue aumentando, preocuparse por el combustible es cada vez más importante que nunca. Sin embargo, es difícil vigilar adecuadamente la eficiencia del combustible sin obtener una lectura del nivel de combustible precisa. Lecturas del nivel de combustible falso pueden resultar en pérdida de tiempo y gastos innecesarios.



OE NUMBERS
CAN TYPICALLY
BE FOUND ON THE
MOUNTING PLATES
OR SHAFT OF
FUEL SENDERS



Fuel Sender

Dorman# 285-5203 OE# A22-42390-005

Make: Freightliner

Years: 1999-94

Models: Classic, FL, FLD Series



Fuel Sender

Dorman# 285-5101 OE# 2585993C91

Make: International

Years: 2011-01

Models: 3200 Bus Chassis, 4100, 4200, 4300, 4400, 5500i, 5600i, Severe Service, 7300, 7400, 7500, 7600, Severe Service



Fuel Sender

Dorman# 285-5103 OE# 3596382C92

Make: International

Years: 2011-96

Models: 9400 premium Conventional., 9800 Premium Cab Over Engine, 9900 Premium Conventional

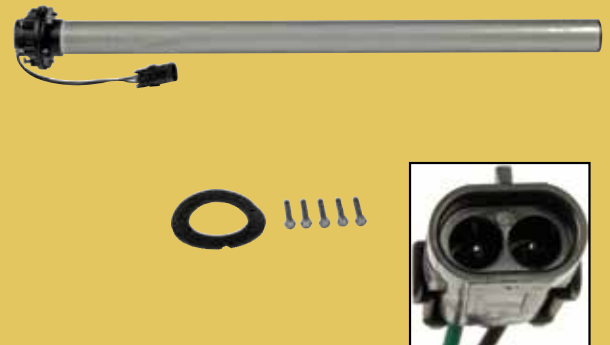

Fuel Sender

Dorman# 285-5104 OE# 476846C2

Make: International

Years: 2011-97

Models: 1400, 1600, Stripped Chassis, 1652, UPS Chassis, 2500, 2600, 3000, 3400, 3600, 3700, 3800, 3900, Bus Chassis, 4500, 4600, 4700, 4800, 4900, 5000 Severe Service, 7100, 8100 Heavy Tractor.

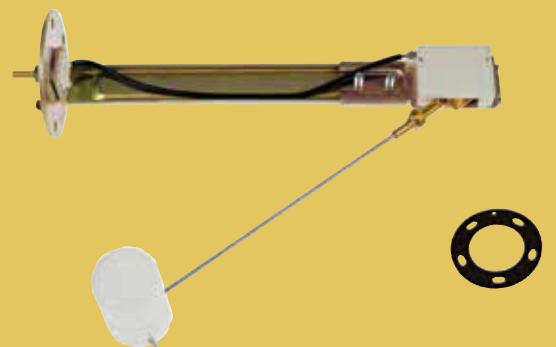

Fuel Senders, Fuel and Emissions

Envíos de combustible, combustible y emisiones



Fuel Sender

Dorman# 285-5105 **OE#** 497840C96

Make: International

Years: 1991-85

Models: All International models

Notes: 100 & 50 Gallon 23" Tanks, 50 60 70 and 90 Gallon 26" Tanks



Fuel Sender

Dorman# 285-5404 **OE#** Q21-1024-622

Make: Kenworth

Years: 2011-87

Models: All Kenworths with a fuel tank sender for 24.5 diameter fuel tank



Fuel Sender

Dorman# 285-5405 **OE#** Q21-1024-559

Make: Kenworth

Years: 2011-87

Models: All Kenworths with a fuel tank sender for 22.5 diameter fuel tank



Fuel Sender

Dorman# 285-5406 **OE#** Q21-1043-622

Make: Kenworth

Years: 2011-87

Models: All Kenworths with a fuel tank sender for 24.5 diameter fuel tank

Fuel Sender

Dorman# 285-5501 OE# 20506805

Make: Mack
Years: 2011-07
Models: GU, CTP, CT



Fuel Sender

Dorman# 285-5502 OE# 25172994

Make: Mack
Years: 2003
Models: CV



Fuel Sender

Dorman# 285-5503 OE# 16MB48DP13

Make: Mack
Years: 2003-91
Models: DM, MR Models Rectangle Tank



Fuel Sender

Dorman# 285-5504 OE# 25172995

Make: Mack
Years: 2004-02
Models: CV



Fuel Senders, Fuel and Emissions

Envíos de combustible, combustible y emisiones



Fuel Sender

Dorman# 285-5505 **OE#** 16MB48DP29

Make: Mack
Years: 2010-08
Models: CH,CX



Fuel Sender

Dorman# 285-5506 **OE#** 25101400

Make: Mack
Years: 2003-95
Models: CH,CX

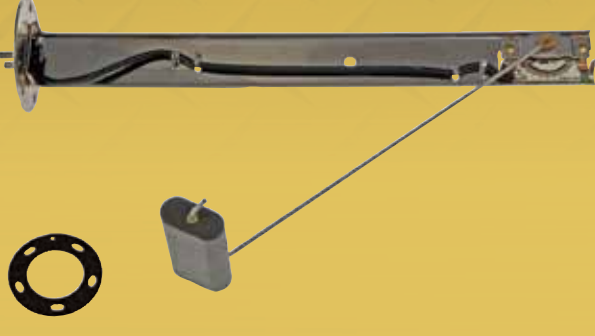

Fuel Sender

Dorman# 285-5507 **OE#** 25195325

Make: Mack
Years: 2009-89
Models: RD

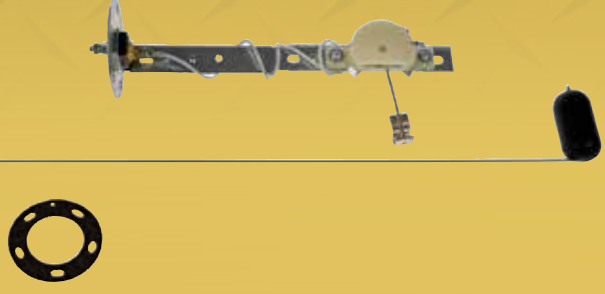

Fuel Sender

Dorman# 285-5508 **OE#** 8609-NC2759

Make: Mack
Years: 2011-95
Models: Universal Fit

Fuel Sender

Dorman# 285-5401 OE# K21-6001-661

Make: Peterbilt

Years: 2011-87

Models: All Peterbilt models

Notes: With a 26" diameter fuel tank

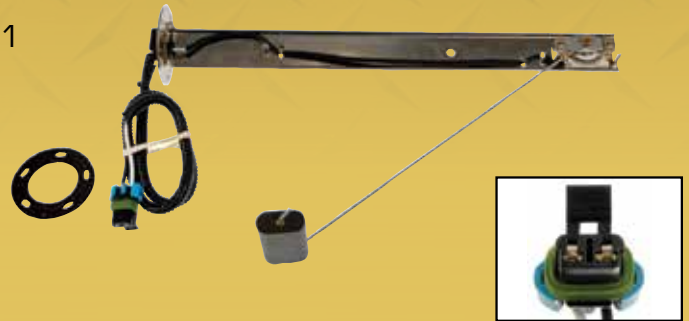

Fuel Sender

Dorman# 285-5402 OE# K21-6001-585

Make: Peterbilt

Years: 2011-87

Models: All Peterbilt models

Notes: With a 23" diameter fuel tank



Fuel Sender

Dorman# 285-5403 OE# 391PLP

Make: Peterbilt & Kenworth

Years: 2011-87

Models: All Models

Notes: Universal Fit

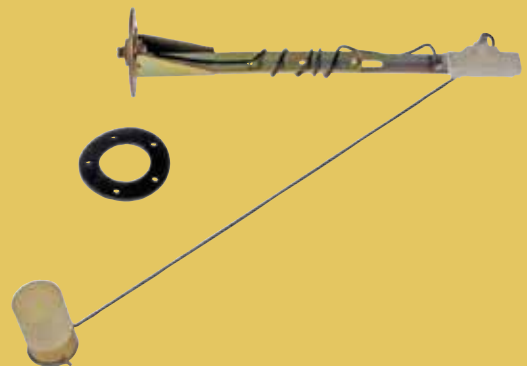

Fuel Sender

Dorman# 285-5509 OE# 3092993

Make: Volvo

Years: 2009-90

Models: WA, WG, WX

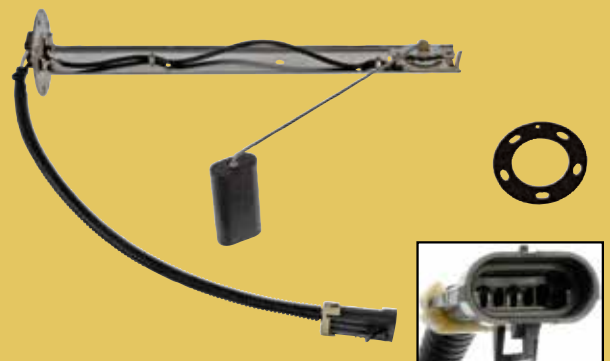

Fuel Senders, Fuel and Emissions

Envíos de combustible, combustible y emisiones



DEF Cap

Dorman# 904-5701 OE# 52122496AD

Make: Dodge

Years: 2012-10

Models: All Medium and Heavy Duty Trucks



DEF Cap

Dorman# 904-5301 OE# AU5Z5K204A

Make: Ford

Years: 2012-10

Models: All Light and Medium Duty Trucks



DEF Cap

Dorman# 904-5201 OE# 04-27757-000

Make: Freightliner

Years: 2012-10

Models: All Medium and Heavy Duty Trucks



DEF Cap

Dorman# 904-5601 OE# 22753134

Make: GM

Years: 2012-10

Models: All Light and Medium Duty Trucks

DEF Cap

Dorman# 904-5401 OE# 908-0223-01

Make: Kenworth
Years: 2012-10
Models: All Trucks



DEF Cap

Dorman# 904-5501 OE# 21148728

Make: Mack
Years: 2012-10
Models: All Trucks
Notes: Non-Locking Tanks
(Mack and Volvo)



DEF Cap

Dorman# 904-5401 OE# 908-0223-01

Make: Peterbilt
Years: 2012-10
Models: All Trucks



DEF Cap

Dorman# 904-5502 OE# 21148725

Make: Volvo
Years: 2012-10
Models: All Trucks
Notes: Locking Tanks
(Mack and Volvo)





SOLUTIONS

A Better Alternative to the OE Dealer

Dorman offers Formerly “Dealer Only” Parts to the Heavy Duty Aftermarket

Customers benefit from the added value of the products offered through the Dorman HD Solutions™ program:

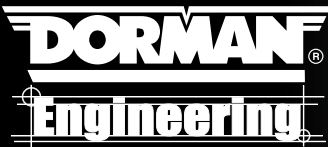

Dorman parts are often redesigned to provide a more reliable parts solution. Through the collection and examination of failed OE parts our engineers are able to determine how and why parts fail. Even more importantly, they are able to redesign parts with a focus on reducing (or eliminating) common failure patterns. Better designs and better materials result in more reliable parts you can take advantage of.



Many Dorman parts are offered as Complete Kits. With an eye towards saving you time and money, Dorman’s product teams solicit feedback from technicians and field professionals to properly understand everything that is required for a complete repair for some specific parts. The input Dorman collects from professionals with firsthand experience is then leveraged into the development of Dorman Complete Kits – parts that provide you with everything needed to complete the job. One phone call, one part number – saves you money and cuts down on repair time.

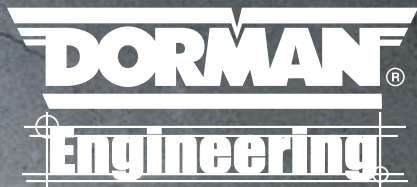

IMPROVED PARTS FOR BETTER RELIABILITY

Hood Cable

Our heavier gauge cable is designed with upgraded materials, increasing strength and reliability.

Dorman #
924-5402



Original Hood Cable

Fluid Reservoir

Our transparent bottle makes the need for a sight gauge obsolete, thereby eliminating two possible leak points.

Dorman #
603-5602



Original Fluid Reservoir



INCLUDES EVERYTHING NEEDED FOR A COMPLETE REPAIR

Door Check

One Dorman kit saves time and money by providing four parts that the Dealer offers only separately.



Dorman # 924-5401 (Includes All Parts Shown)

Headlights and Lighting

Faros e iluminación

Nothing ruins the appearance of a stunning truck like a faded or broken headlight. You work hard to keep your rig looking great. In an instant, a collision or debris kicked up from the road can ruin that image. Headlights also wear over time and leave you with that yellowish tint that we have all seen before. You never want to see these situations happen but, unfortunately, they are inevitable.

With new CSA regulations in place, the stakes have never been higher. Drivers are at risk of having their licenses suspended if they fail to comply with these regulations. You can no longer afford to put off the replacement of a headlight. The next time you find yourself in this situation, rest assured that Dorman will be your source for application-specific headlights.

Los faros pueden sustituirse por una variedad de razones diferentes. Quizás las razones más evidentes para sustituir los faros son las colisiones. Es prácticamente inevitable que con el tiempo un camión esté involucrado en un accidente, y los faros tendrán que ser sustituido inmediatamente.

Los faros también pueden desgastarse con el tiempo. Los materiales del lente con el cual se construyen los faros pueden desgastarse, causando la emisión un tinte amarillento opaco al rayo de luz. Reglamentaciones nuevas del CSA amenazan con poner faltas a la licencia del conductor, así que deben cambiarse las luces desgastadas y opacas sin ninguna demora.



OE NUMBERS CAN
TYPICALLY BE FOUND
ON THE BACKSIDE
OF HEADLIGHT
ASSEMBLIES



Headlight Right

Dorman# 888-5101 OE# 3605817C92

Make: International

Years: 2011-09

Models: WorkStar



Headlight Left

Dorman# 888-5102 OE# 3605816C92

Make: International

Years: 2011-09

Models: WorkStar



Headlight Right

Dorman# 888-5103 OE# 3502929C94

Make: International

Years: 2008-94

Models: 5900, 9200



Headlight Left

Dorman# 888-5104 OE# 3502928C94

Make: International

Years: 2008-94

Models: 5900, 9200





Headlight Right

Dorman# 888-5105 **OE#** 3574388C91

Make: International

Years: 2011-08

Models: 4000, 7000, 8500, and RXT



Headlight Left

Dorman# 888-5106 **OE#** 3574387C91

Make: International

Years: 2011-08

Models: 4000, 7000, 8500, and RXT



Fog Light

Dorman# 924-5201 **OE#** A06-75742-000

Make: Freightliner

Years: 2010-04

Models: Columbia



Headlight Screw

Dorman# 924-5104 **OE#** 500565C91

Make: International

Years: 2005-84

Models: 9400, S-Series, Prostar and 9670

Headlight Switch

Dorman# 901-5206 OE# A06-30769-010

Make: Freightliner

Years: 2011-01

Models: Columbia



**BE THE FIRST
TO KNOW!** 

ABOUT FORMERLY "DEALER ONLY" PARTS

Sign up for Dorman HD Solutions
Be the First to Know Program

Receive the latest New Product
Releases for all of our Formerly
"Dealer Only" Parts.

- Get New Product Emails
- Learn More About
Formerly Dealer
Only Parts

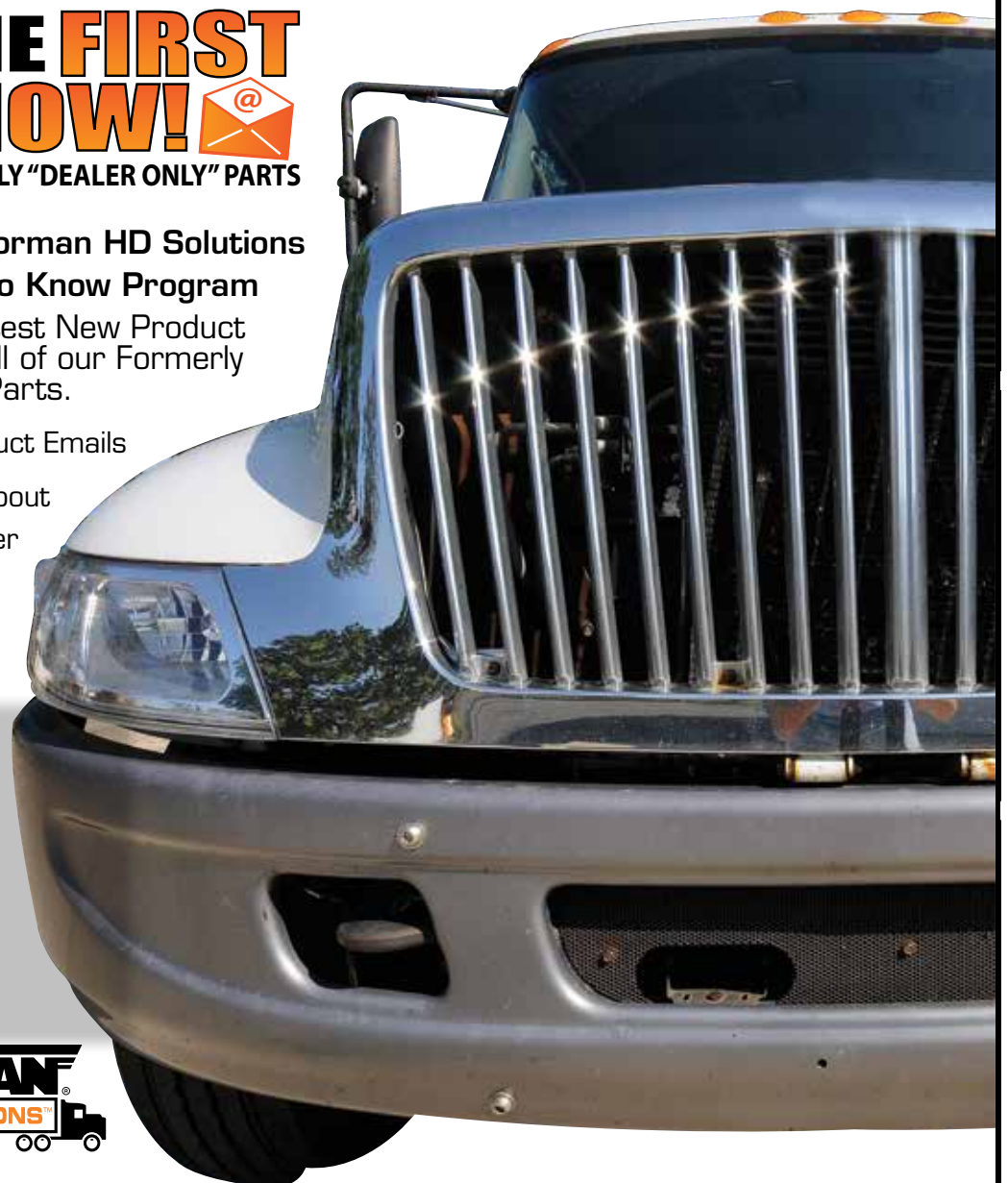

Hood Springs, Latches and Components

Resortes del capó, cierres y componentes

It seems that any time you open the hood of a truck you see nothing but rust on the components that actually hold that hood in place! When you think about the weight associated with the hood of a truck it is shocking that the hood components expected to support this load are often found in such deteriorating condition. Aside from exposure to contaminants, excessive engine heat and vibration – the parts also suffer from poor designs!

Dorman has been able to identify and develop a complete line of alternatives for these failure prone components. By hitting the streets and examining both fleet and salvage vehicles, our engineers have identified the most sought out hood components and made them more reliable. Materials have been improved from low-grade metals to high quality stainless steel and many components are offered as complete kits containing everything you will need to complete the job.

Los Resortes del capó se encuentran bajo el capó del camión, donde nada protege contra la exposición del aire húmedo y las condiciones climáticas difíciles. Como muchas otras piezas, los resortes del capó son vulnerables a óxido y la corrosión, que hace que se debiliten. Como el capó de un camión es muy pesado, un resorte debilitado puede fácilmente soltarse y romperse.

El capó típicamente es sostenido por una serie de resortes. Si uno de los resortes falla, por excesivo peso los demás resortes potencialmente podrían provocar un fallo también.

La exposición extendida a temperaturas frías también puede ser perjudicial para los resortes del capó, causando que sean frágiles y se debiliten. Como los resortes deben expandirse para acomodar el peso del capó cuando esté abierto, los efectos perjudiciales del clima frío pueden hacerlos más susceptibles a soltarse y romperse.



OE NUMBERS CAN
TYPICALLY BE FOUND
PRINTED ON THE
SURFACE OF HOOD
LATCHES OR ON THE
MOUNTING BRACKETS

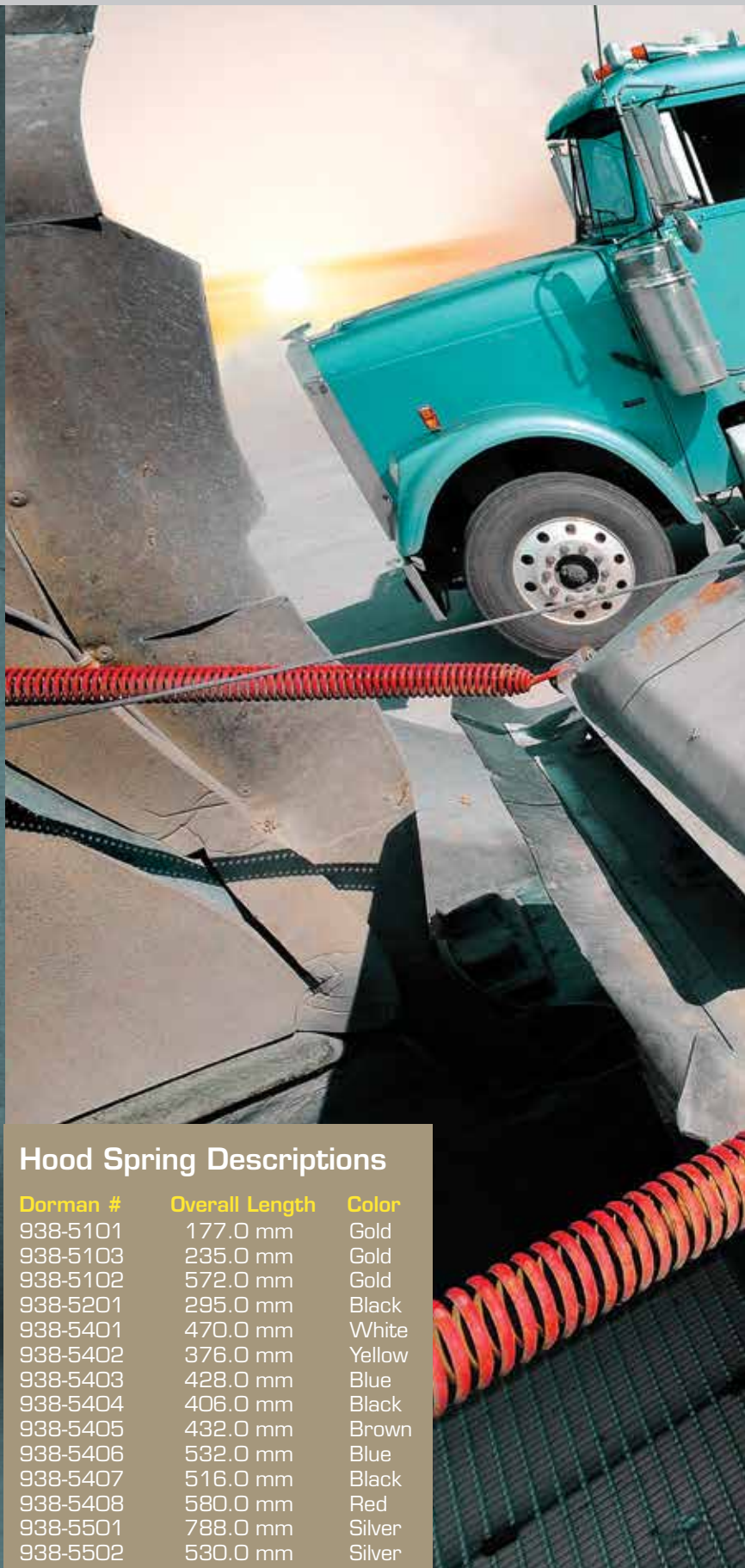

Hood Spring Descriptions

| Dorman # | Overall Length | Color |
|----------|----------------|--------|
| 938-5101 | 177.0 mm | Gold |
| 938-5103 | 235.0 mm | Gold |
| 938-5102 | 572.0 mm | Gold |
| 938-5201 | 295.0 mm | Black |
| 938-5401 | 470.0 mm | White |
| 938-5402 | 376.0 mm | Yellow |
| 938-5403 | 428.0 mm | Blue |
| 938-5404 | 406.0 mm | Black |
| 938-5405 | 432.0 mm | Brown |
| 938-5406 | 532.0 mm | Blue |
| 938-5407 | 516.0 mm | Black |
| 938-5408 | 580.0 mm | Red |
| 938-5501 | 788.0 mm | Silver |
| 938-5502 | 530.0 mm | Silver |

Hood Spring

Dorman# 938-5201 OE# 17-12069-001

Make: Freightliner

Years: 2005-89

Models: FLD/FLC, Classic models

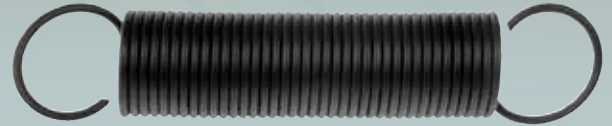

Hood Spring

Dorman# 938-5101 OE# 1675762C3

Make: International

Years: 2001-89

Models: S-model, 3000 series bus,
4000 series



Hood Spring

Dorman# 938-5102 OE# 3588532C2

Make: International

Years: 2011-86

Models: 2000, 8000, 9000 series



Hood Spring

Dorman# 938-5103 OE# 598574C3

Make: International

Years: 2010-96

Models: 9200 and 9400 only



Hood Springs, Latches and Components

Resortes del capó, cierres y componentes



Hood Spring

Dorman# 938-5401 **OE#** L71-1002

Make: Kenworth

Years: 2011-99

Models: W900L w/ Fiberglass hood



Hood Spring

Dorman# 938-5402 **OE#** K224-95

Make: Kenworth

Years: 2003-98

Models: T400, T450, T800



Hood Spring

Dorman# 938-5403 **OE#** K224-86

Make: Kenworth

Years: 2006-98

Models: C500B, T800, W900B



Hood Spring

Dorman# 938-5404 **OE#** K224-35

Make: Kenworth

Years: 2006-98

Models: C500, W900B

Hood Spring

Dorman# 938-5405 **OE#** L71-1004

Make: Kenworth

Years: 2011-99

Models: W900L w/ Metton hood



Hood Spring

Dorman# 938-5408 **OE#** K224-81

Make: Kenworth

Years: 2006-98

Models: T600, T800, W900



Hood Spring

Dorman# 938-5501 **OE#** 25171284

Make: Mack

Years: 2011-99

Models: Vision, CX models inc CXP



Hood Spring

Dorman# 938-5502 **OE#** 25158019

Make: Mack

Years: 2011-99

Models: CH models, CV models



Hood Springs, Latches and Components

Resortes del capó, cierres y componentes



Hood Spring

Dorman# 938-5406 **OE#** 13-04638

Make: Peterbilt

Years: 2008-87

Models: 357, 377, 379 with 119"
(long hood)



Hood Spring

Dorman# 938-5407 **OE#** 13-03569

Make: Peterbilt

Years: 2008-87

Models: 357, 378, 377, 379, with 127"
(short hood)



Hood Latch Kit Right/Left

Dorman# 315-5201 **OE#** 17-12438-000

Make: Freightliner

Years: 2009-97

Models: FLD 120, Classic

Notes: Straight Front Axle

Kits Include Latch, Mounting Brackets and Hardware.

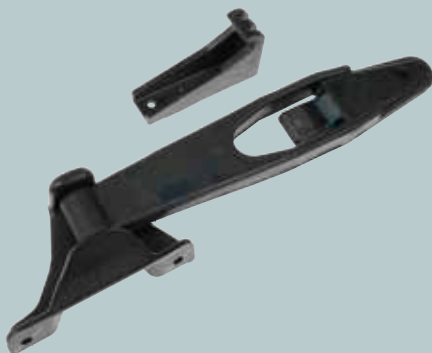

Hood Latch Kit Right

Dorman# 315-5202 **OE#** A17-15553-001

Make: Freightliner

Years: 2008-95

Models: Columbia

Kits Include Latch, Mounting Brackets and Hardware.

Hood Springs, Latches and Components

Resortes del capó, cierres y componentes

Hood Latch Kit Left

Dorman# 315-5203 **OE#** A17-15553-000

Make: Freightliner

Years: 2008-95

Models: Columbia



Kits Include Latch, Mounting Brackets and Hardware.

Hood Latch Kit Right

Dorman# 315-5204 **OE#** 17-12435-001

Make: Freightliner

Years: 2009-97

Models: FLD 120, Classic

Notes: Offset Axle



Kits Include Latch, Mounting Brackets and Hardware.

Hood Latch Kit Left

Dorman# 315-5205 **OE#** 17-12435-000

Make: Freightliner

Years: 2008-01

Models: 2009-97

Notes: Offset Axle



Kits Include Latch, Mounting Brackets and Hardware.

Hood Latch Kit Right/Left

Dorman# 315-5101 **OE#** 499523C3 (Latch Only),
1699929C9

Make: International

Years: 2011-79

Models: 1000, 2000, 4000, 7000, 8000,
9000 and S-Series



Kits Include Latch, Mounting Brackets and Hardware.

Hood Springs, Latches and Components

Resortes del capó, cierres y componentes



Hood Latch Kit Right/Left

Dorman# 315-5401 **OE#** L56-0001

Make: Kenworth

Years: 2011-87

Models: W900, T600, T300, T800

Kits Include Latch, Mounting Brackets and Hardware.



Hood Latch Kit Right/Left

Dorman# 315-5402 **OE#** K147-107

Make: Kenworth

Years: 2005-87

Models: Models W900B, T600A

Notes: 1987-85 T800

Kits Include Latch, Mounting Brackets and Hardware.



Hood Latch Kit Right

Dorman# 315-5502 **OE#** 25169065

Make: Mack

Years: 2011-01

Models: CH, CHN, CXN, CV

Notes: From 05/09/01

Kits Include Latch, Mounting Brackets and Hardware.



Hood Latch Kit Left

Dorman# 315-5503 **OE#** 25159428

Make: Mack

Years: 2011-02

Models: CH, CHN, CXN, CV

Notes: From 05/09/01

Kits Include Latch, Mounting Brackets and Hardware.

Hood Springs, Latches and Components

Resortes del capó, cierres y componentes

Hood Latch Kit Right/Left

Dorman# 315-5401 **OE#** L56-0001 (Latch Only),
23-13857 (Kit)

Make: Peterbilt

Years: 2011-87

Models: 357, 359, 367, 377, 378, 379,
388, 389



Kits Include Latch, Mounting Brackets and Hardware.

Hood Latch Kit Right/Left

Dorman# 315-5501 **OE#** 8174018

Make: Volvo

Years: 2002-91

Models: AC, WA, WC, WG, WI



Kits Include Latch, Mounting Brackets and Hardware.

Hood Cable

Dorman# 924-5206 **OE#** A17-12082-000

Make: Freightliner

Years: 2005-89

Models: FLD, FLC, Classic models

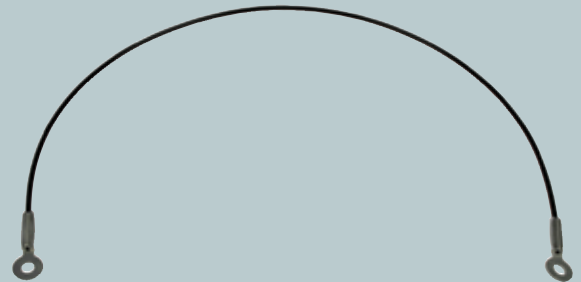

Hood Cable

Dorman# 924-5207 **OE#** A17-12081-000

Make: Freightliner

Years: 2005-89

Models: FLD, FLC, Classic models



Hood Springs, Latches and Components

Resortes del capó, cierres y componentes

Hood Cable



Dorman# 924-5501 **OE#** 25152850

Make: Mack

Years: 1995-90

Models: CH models with Axle Forward

Hood Cable



Dorman# 924-5502 **OE#** 25171452

Make: Mack

Years: 2003-90

Models: RD models

Hood Cable



Dorman# 924-5402 **OE#** L92-6000-0718

Make: Peterbilt

Years: 2005-87

Models: 357, 367, 375, 377, 378, 379

Notes: Improved Design With Heavier Cable Gauge And Upgraded Materials

Left



Right



Hood Rest

Dorman# 924-5203(R) **OE#** A17-13787-003

924-5202(L) A17-13787-002

Make: Freightliner

Years: 2008-01

Models: Columbia

Now It's Faster & Easier to Find the Parts You Need



powered by 

SEARCH ENHANCEMENTS:

✓ Synonyms / Aliases



✓ Auto-Complete

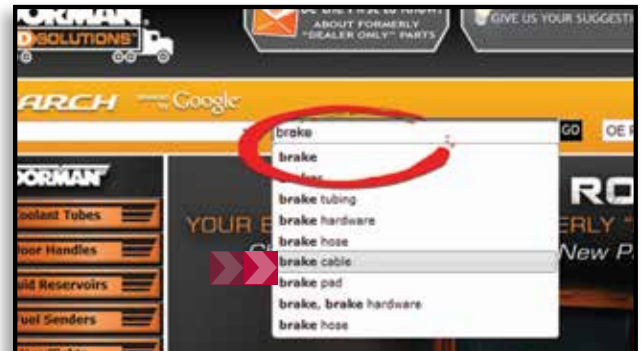

✓ Vehicle Application Search with keyword

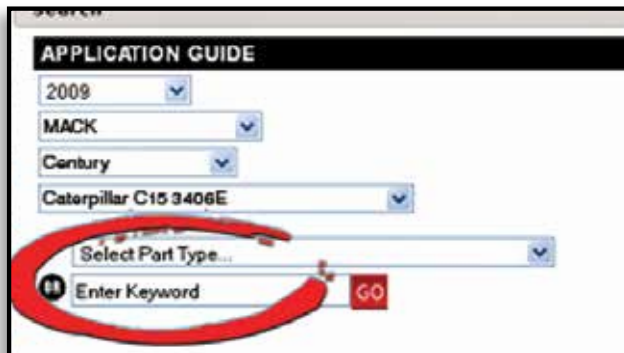

✓ Spelling suggestions enhancement



Speed Sensors and Tachometer Sensors

Sensores de velocidad y sensores de tacómetro

Speed sensors and tachometer sensors are responsible for reading important information regarding the performance of your truck. Unfortunately, these sensors are not always engineered to handle these tasks. The parts are constantly stressed due to their location. Plastic material is often used to create these parts which can become brittle and wear from the extreme temperatures and road debris that constantly bombard them.

Our focus in developing alternatives for speed and tachometer sensors centers on overcoming these common failure patterns. After investing resources examining faulty sensors with an eye towards alternative designs, our parts were developed using a magnetic sensor made from a stronger aluminum material. This improvement eliminates many of the problems associated with plastic sensors. With the Dorman HD Solutions sensors, you are left with a more dependable part and a more dependable truck.

Los sensores de velocidad y tacómetro están bajo constante presión debido a su ubicación. La exposición a los elementos amenaza la longevidad de estas piezas: el calor y frío extremo pueden desgastar los materiales de los cual están contruidos los sensores. Por otra parte, el agua de la carretera puede salpicar en ellos y potencialmente congelar en hielo, haciendo la función magnética funcione pobremente y posiblemente se desgaste en tamaño. Incluso los desechos levantados desde la carretera durante la operación del vehículo pueden dañar los sensores. Cualquiera que sea la causa, con el tiempo, la parte puede dañarse, causando información inexacta para el conductor del camión.



Speed Sensor

Dorman# 505-5201 OE# SAA85920008

Make: Freightliner

Years: 2011-89

Models: All Freightliner models

Notes: A screw in speed sensor with a Merritor transmission with an internal tone ring



Speed Sensor

Dorman# 505-5104 OE# 2503117C1

Make: International

Years: 1998-90

Models: 9600, 9700

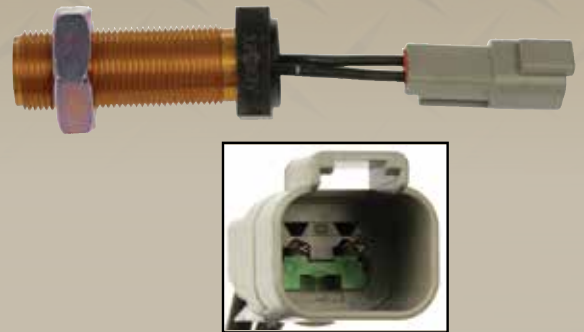

Speed Sensor

Dorman# 505-5105 OE# 3528003C1

Make: International

Years: 2007-97

Models: 1000, 4000, 5000, 7000, 8000, and 9000 series

Notes: Built after May 1997 and later

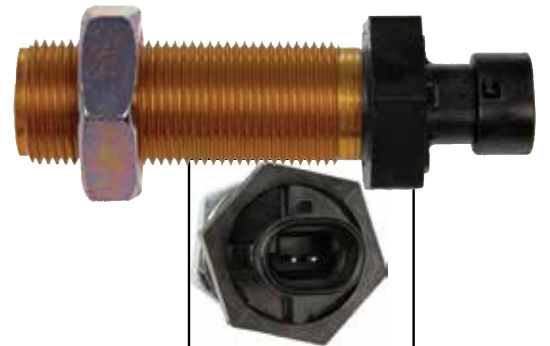

Speed Sensor

Dorman# 505-5505 OE# 25166488

Make: Mack

Years: 2010-89

Models: All Mack models

Notes: Screw in sensor with Eaton Transmission



Speed Sensors and Tachometer Sensors

Sensores de velocidad y sensores de tacómetro



Speed Sensor

Dorman# 505-5512 **OE#** 20706327

Make: Mack

Years: 2011-97

Models: All Mack models

Notes: Push in sensor in timing cover or bell housing



Speed Sensor

Dorman# 505-5510 **OE#** 8029939

Make: Volvo

Years: 2011-89

Models: All Volvo models

Notes: Detroit Diesel



Tachometer Sensor

Dorman# 505-5501 **OE#** 64MT2105M

Make: Mack

Years: 1995-87

Models: RD, CH Models

Notes: Mack engine

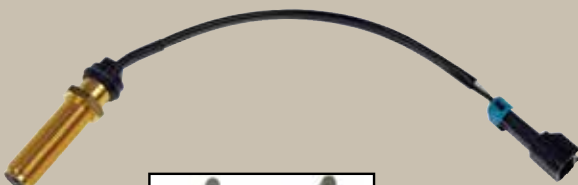

Tachometer Sensor

Dorman# 505-5504 **OE#** 64MT435

Make: Mack

Years: 2001-90

Models: CH, MR models

Notes: Magnum 430HP

Tachometer Sensor

Dorman# 505-5506 OE# 64MT440M

Make: Mack

Years: 2010-89

Models: RD, CH Models

Notes: All except Magnum 430HP



Tachometer Sensor

Dorman# 505-5511 OE# 8078108

Make: Volvo

Years: 2011-89

Models: All Volvo models

Notes: Detroit Diesel



Tachometer & Speed Sensor

Dorman# 505-5406 OE# Q21-6005

Make: Kenworth

Years: 2011-95

Models: All Kenworth models

Notes: Eaton trans with internal tone ring, mounts in tailshaft

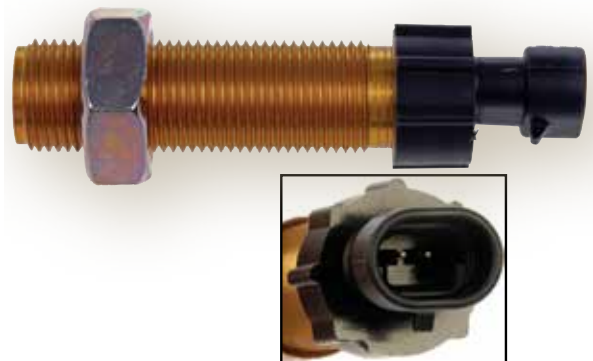

Tachometer & Speed Sensor

Dorman# 505-5407 OE# K3454

Make: Kenworth

Years: 2011-95

Models: All Kenworth models

Notes: Eaton trans that has external tone ring (2 pin connector)



Speed Sensors and Tachometer Sensors

Sensores de velocidad y sensores de tacómetro

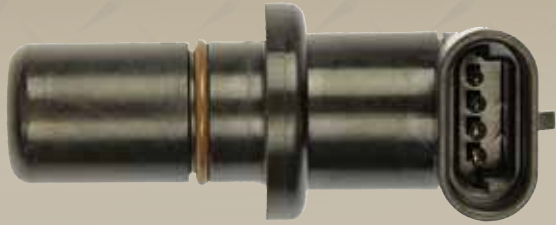

Tachometer & Speed Sensor

Dorman# 505-5408 OE# K3455

Make: Kenworth

Years: 2011-95

Models: All Kenworth models

Notes: Eaton trans that has external tone ring (4 pin connector)



Tachometer & Speed Sensor

Dorman# 505-5507 OE# 64MT412M

Make: Mack

Years: 1990-67

Models: RD, CH, MR, DM models



Tachometer & Speed Sensor

Dorman# 505-5406 OE# Q21-6005

Make: Peterbilt

Years: 2011-95

Models: All Peterbilt models

Notes: Eaton trans with internal tone ring, mounts in tailshaft



Tachometer & Speed Sensor

Dorman# 505-5407 OE# K3454

Make: Peterbilt

Years: 2011-95

Models: All Peterbilt models

Notes: Eaton trans that has external tone ring (2 pin connector)

Tachometer & Speed Sensor

Dorman# 505-5408 OE# K3455

Make: Peterbilt

Years: 2011-95

Models: All Peterbilt models

Notes: Eaton trans that has external tone ring (4 pin connector)



4WD Transfer Case Motor

Dorman# 600-909 OE# 88962312

Make: GMC

Years: 2008-05

Models: C4500, C5500 Series



Window Regulators and Window Parts

Reguladores de ventana y partes para la ventana

There is no feeling quite like it. The sky is blue, the sun is shining, and you have your arm rested on your door with the wind in your hair. It is an amazing feeling. Nothing should prevent a driver from being able to experience this sense of freedom. Unfortunately, a damaged window regulator will do just that.

You roll your window down for a variety of reasons: paying tolls, smoking, enjoying the weather, communicating with people and any number of other reasons. Losing the ability to simply operate the window normally can make your drive uncomfortable. Poor design and low quality materials are often contributing factors when dealing with broken regulators. Through the collection of these failed samples and rigorous cycle testing done in our state-of-the-art laboratory Dorman has developed window regulators that meet the needs of the only person that matters... you.

Los reguladores de la ventana comúnmente fallan debido a la frecuencia con que se utilizan las piezas. El conductor baja sus ventanas por diferentes razones: fumar, pagar peajes, disfrutando del clima, comunicarse con personas, etc. Su funcionamiento regular hace que esta pieza se desgaste en una cantidad considerable.

Los reguladores de la ventana manual tienen los dientes del engranaje que permiten a la ventana para subir o bajar. Estos dientes pueden desgastarse con el tiempo y eventualmente causar que el regulador brinque o deje de funcionar completamente.

Los reguladores de la ventana con motores de potencia también suelen fallar. Con el tiempo, los cables que suben y bajan la ventana pueden debilitarse y soltarse, y pueden desgastar los dientes del engranaje del motor del interfaz con el regulador. Con cualquiera de estos acontecimientos va a necesitar reemplazar la pieza.



OE NUMBERS CAN
TYPICALLY BE FOUND
STAMPED ON THE
MOUNTING BRACKETS
OR BODY OF WINDOW
REGULATORS



Window Regulator, Manual

Front Right

Dorman# 740-652 **OE#** E7TZ 1523200-A

Make: Ford

Years: 1991-80

Models: F350, F450, F550, F650,
F750, F800



Window Regulator, Manual

Front Left

Dorman# 740-653 **OE#** E7TZ 1523201-A

Make: Ford

Years: 1991-80

Models: F350, F450, F550, F650,
F750, F800

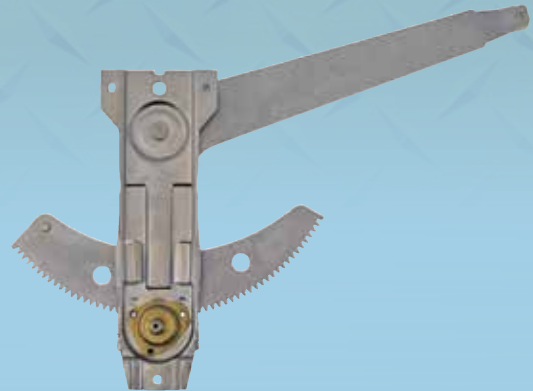

Window Regulator, Manual

Front Left

Dorman# 749-075 **OE#** 22071951

Make: GMC

Years: 2002-90

Models: Kodiak/Topkick 4500, 5500



Window Regulator, Manual

Front Right

Dorman# 749-076 **OE#** 22071950

Make: GMC

Years: 2002-90

Models: Kodiak/Topkick 4500, 5500



Window Regulators and Window Parts

Reguladores de ventana y partes para la ventana



Window Regulator, Manual

Front Right

Dorman# 740-5103 **OE#** 1686705C91

Make: International

Years: 2005-84

Models: S-Series and 4000 Series

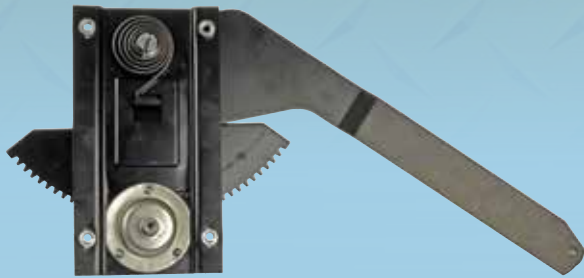

Window Regulator, Manual

Front Left

Dorman# 740-5104 **OE#** 1686704C91

Make: International

Years: 2005-84

Models: S-Series and 4000 Series



Window Regulator, Manual

Front Left

Dorman# 740-5501 **OE#** 25191027

Make: Mack

Years: 2011-90

Models: MR688S, MR686S



Window Regulator, Manual

Front Right

Dorman# 740-5502 **OE#** 25191633

Make: Mack

Years: 2011-90

Models: MR688S, MR686S

Window Regulator, Manual

Front Left

Dorman# 740-5503 **OE#** 25113357

Make: Mack

Years: 2011-90

Models: MR688S, MR686S



Window Regulator, Manual

Front Right

Dorman# 740-5504 **OE#** 25114490

Make: Mack

Years: 2011-90

Models: MR688S, MR686S



Window Regulator, Manual

Front Left

Dorman# 740-5505 **OE#** 25161668

Make: Mack

Years: 2001-90

Models: RD688S, RD686S



Window Regulator, Manual

Front Right

Dorman# 740-5506 **OE#** 25160158

Make: Mack

Years: 2001-90

Models: RD688S, RD686S



Window Regulators and Window Parts

Reguladores de ventana y partes para la ventana



Window Regulator, Manual

Front Left

Dorman# 740-5507 **OE#** 25169077

Make: Mack

Years: 2002-97

Models: CH613



Window Regulator, Manual

Front Right

Dorman# 740-5508 **OE#** 25169076

Make: Mack

Years: 2002-97

Models: CH613



Window Regulator, Power

Front Left

Dorman# 748-180 **OE#** 8C3Z2523201C

Make: Ford

Years: 2005-04

Models: Excursion, 2010-04 F-250SD,
F-350SD, F-450SD, F-550SD

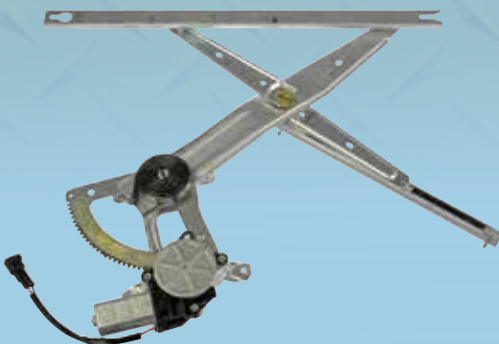

Window Regulator, Power

Front Right

Dorman# 748-181 **OE#** 8C3Z2523200C

Make: Ford

Years: 2005-04

Models: Excursion, 2010-04 F-250SD,
F-350SD, F-450SD, F-550SD

Window Regulator, Power

Front Left

Dorman# 748-212 **OE#** 1C3Z2523201BA

Make: Ford

Years: 2003-00

Models: Excursion, F-250SD, F-350SD,
F-450SD, F-550SD

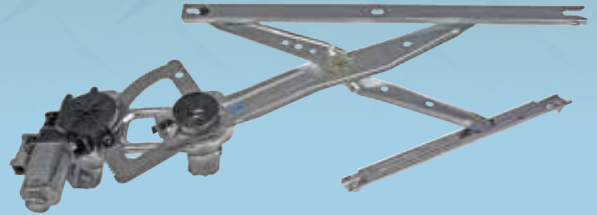

Window Regulator, Power

Front Right

Dorman# 748-213 **OE#** 1C3Z2523200BA

Make: Ford

Years: 2003-00

Models: Excursion, F-250SD, F-350SD,
F-450SD, F-550SD



Window Regulator, Power

Front Right

Dorman# 741-5201 **OE#** A18-48952-001

Make: Freightliner

Years: 2011-90

Models: FLD, FLD Classic



Window Regulator, Power

Front Left

Dorman# 741-5202 **OE#** A18-48952-000

Make: Freightliner

Years: 2011-90

Models: FLD, FLD Classic



Window Regulators and Window Parts

Reguladores de ventana y partes para la ventana

Window Regulator, Power

Front Right

Dorman# 741-5203 **OE#** A18-52044-001

Make: Freightliner

Years: 2011-97

Models: CST112, C112, CST120, C120, Century, Argosy



Window Regulator, Power

Front Left

Dorman# 741-5204 **OE#** A18-52044-000

Make: Freightliner

Years: 2011-97

Models: CST112, C112, CST120, C120, Century, Argosy



Window Regulator, Power

Front Right

Dorman# 741-654 **OE#** 22071948

Make: GMC

Years: 2002-90

Models: Kodiak/Topkick 4500, 5500



Window Regulator, Power

Front Left

Dorman# 741-655 **OE#** 22071949

Make: GMC

Years: 2002-90

Models: Kodiak/Topkick 4500, 5500



Window Regulator, Power

Front Right

Dorman# 741-5101 **OE#** 3515113C92

Make: International

Years: 2011-03

Models: 2000, 3000, 4000, 7000, 8000,
9000 Series



Window Regulator, Power

Front Left

Dorman# 741-5102 **OE#** 3515112C92

Make: International

Years: 2011-03

Models: 2000, 3000, 4000, 7000, 8000,
9000 Series



Window Regulator, Power

Front Left

Dorman# 741-5403 **OE#** R21-1005

Make: Kenworth

Years: 2011-09

Models: W900, T600, T800

Notes: Daylite Door



Window Regulator, Power

Front Right

Dorman# 741-5404 **OE#** R21-1005R

Make: Kenworth

Years: 2011-09

Models: W900, T600, T800

Notes: Daylite Door



Window Regulators and Window Parts

Reguladores de ventana y partes para la ventana

Window Regulator, Power

Front Left

Dorman# 741-5401 **OE#** R21-6011

Make: Peterbilt

Years: 2005-87

Models: 357, 365, 367, 378, 379, 388, 389



Window Regulator, Power

Front Right

Dorman# 741-5402 **OE#** R21-6011R

Make: Peterbilt

Years: 2005-87

Models: 357, 365, 367, 378, 379, 388, 389

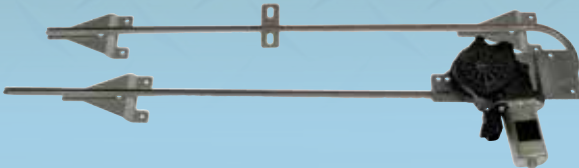

Window Regulator, Power

Front Left

Dorman# 741-5405 **OE#** R21-6013

Make: Peterbilt

Years: 2011-06

Models: 386, 387



Window Regulator, Power

Front Right

Dorman# 741-5406 **OE#** R21-6013R

Make: Peterbilt

Years: 2011-06

Models: 386, 387



Window Lift Motor Kit

Dorman# 742-142 **OE#** 10414628 21171231
 10414630 21171235
 10414632 22143945
Make: GMC, 15221956 22143947
Years: 2009-03 16630577 22154977
 16630579 22154979
Models: Kodiak/Topkick
 4500, 5500,
 6500, 7500,
 8500



Window Lift Motor Kit

Dorman# 742-143 **OE#** 10414629 21171230
 10414631 21171234
 10414633 22063224
Make: GMC, 15221951 22143946
Years: 2009-03 16628208 22143948
 16630576 22154978
Models: Kodiak/Topkick
 4500, 5500,
 6500, 7500,
 8500



Window Switch

Dorman# 901-5204 **OE#** A06-30769-008

Make: Freightliner
Years: 2011-01
Models: Columbia



Window Switch

Dorman# 901-5205 **OE#** A06-30769-027

Make: Freightliner
Years: 2011-01
Models: Columbia



Wiper Transmissions and Dash Components

Transmisiones del limpiaparabrisas y componentes para el tablero de instrumentos

Your truck needs to be on the road regardless of the weather conditions. Rain, snow or sleet won't prevent you from making your delivery. When a truck is out in these conditions the vehicle is depending heavily on the windshield wiper system. As you know, nothing is more critical to this system than a solid wiper transmission.

Unfortunately these parts are often developed poorly. Plastic is frequently used as a bushing in the pivot assemblies. This material fatigues quickly and can end up causing the failure of the entire unit. Dorman has developed part alternatives for the wiper transmissions that fail the most regularly. We've taken the time to work with technicians and fleet specialist to determine which units fail and take steps to develop solutions that keep you and your truck running reliably. The next time the weather is worrisome you won't have to worry at all.

Las transmisiones del limpiaparabrisas aguantan mucho desgaste. El plástico que se utiliza como un casquillo en muchos de los enchufes es particularmente sujetas a daños. El plástico se fatiga fácilmente y finalmente fracasa, haciendo que la transmisión del limpiaparabrisas fracase. Si los pivotes son expulsados de la línea al limpiar los desechos en el parabrisas a mano o con unas herramientas, pueden producir efectos similares. Independientemente de la causa, una transmisión dañada debe ser reemplazada inmediatamente.

Los camiones tienen que estar en el camino independientemente de las condiciones meteorológicas. Por lo tanto, es esencial un sistema fiable de limpiaparabrisas, y nada es más importante para este sistema que la transmisión del limpiaparabrisas. Controla las manijas del limpiaparabrisas, ayudando a asegurar que el parabrisas se mantenga claro durante la lluvia, aguanieve y nieve.



Wiper Transmissions and Dash Components

Transmisiones del limpiaparabrisas y componentes para el tablero de instrumentos

Wiper Transmission

Dorman# 602-5601 **OE#** 8-97855-154-0
8-97855-152-0
8-94165-462-1
8-94165-540-0

Make: Isuzu
Years: 2011-95
Models: NPR/NQR



Instrument Cluster Remanufactured

Dorman# 599-5101 **OE#** 3525091C91

Make: International
Years: 2008-97
Models: 3000 Series buses, 4700 and 4900 Medium Duty Trucks
Notes: With a Mechanical Oil Pressure Gauge



Instrument Cluster Remanufactured

Dorman# 599-5102 **OE#** 3595124C2

Make: International
Years: 2008-97
Models: 2500 Series, 3000 Series buses, 4700 and 4900 Medium Duty Trucks, 8100, 8600 Heavy Duty Trucks
Notes: With a Electronic Oil Pressure Gauge



Multi-Function Switch

Dorman# 978-5201 **OE#** A06-36956-002

Make: Freightliner
Years: 2011-02
Models: M2, C2, Cab & Chassis, Business Class Models



Wiper Transmissions and Dash Components

Transmisiones del limpiaparabrisas y componentes para el tablero de instrumentos



Multi-Function Switch

Dorman# 978-5101 **OE#** 2502912C91

Make: International

Years: 2010-96

Models: Series 3000, 4000 Thomas School Buses with International Chassis



Wiper Nozzle Kit

Dorman# 924-5101 **OE#** 1696499C1

Make: International

Years: 2012-01

Models: 3000,4000, 7000, 8000, 9000



Wiper Nozzle Kit

Dorman# 924-5403 **OE#** 106.811

Make: Peterbilt

Years: 2011-87

Models: 330, 335,357, 367, 375, 377, 378, 379, 388, 389

Notes: Kit Includes Three Nozzles

SIGN UP NOW!

**BE THE FIRST
TO KNOW!**



ABOUT FORMERLY "DEALER ONLY" PARTS

Sign up for The HD Solutions
Be the First to Know Program

- Get New Product Update Emails or Texts
- Learn More About The Latest Formerly Dealer Only Parts



Alphabetical Interchange By Part Type

Intercambio alfabético por el tipo de pieza

| Part Type | Dorman No. | OE No. | Page No. | Part Type | Dorman No. | OE No. | Page No. |
|---------------------------|---------------|--------------------|----------|----------------------------|---------------|--------------------|----------|
| A | | | | H (Cont'd) | | | |
| Air Door Actuator..... | 604-5101..... | 3542606C1..... | 7 | Handle, Exterior..... | 760-5105..... | 2594006C1..... | 13 |
| B | | | | Handle, Exterior..... | 760-5106..... | 2594003C1..... | 13 |
| Brake Pedal Pad..... | 20759..... | 3920296..... | 17 | Handle, Exterior..... | 760-5201..... | A18-42228-003..... | 11 |
| C | | | | Handle, Exterior..... | 760-5202..... | A18-42228-002..... | 11 |
| Coolant Level Sensor..... | 924-5205..... | 06-62384-002..... | 24 | Handle, Exterior..... | 760-5203..... | A18-42228-000..... | 11 |
| Coolant Tank..... | 603-5101..... | 2002105C3..... | 21 | Handle, Exterior..... | 760-5204..... | A18-42228-001..... | 11 |
| Coolant Tank..... | 603-5103..... | 2508700C92..... | 22 | Handle, Exterior..... | 760-5205..... | A18-35381-000..... | 12 |
| Coolant Tank..... | 603-5201..... | 05-23045-000..... | 21 | Handle, Exterior..... | 760-5206..... | A18-35381-001..... | 12 |
| Coolant Tank..... | 603-5202..... | 05-23195-000..... | 21 | Handle, Exterior..... | 760-5207..... | A18-47729-003..... | 12 |
| Coolant Tank..... | 603-5403..... | N5346001..... | 23 | Handle, Exterior..... | 760-5207..... | A18-53241-001..... | 12 |
| Coolant Tank..... | 603-5501..... | 25133601..... | 22 | Handle, Exterior..... | 760-5208..... | A18-47729-002..... | 12 |
| Coolant Tank..... | 603-5502..... | 25174629..... | 22 | Handle, Exterior..... | 760-5208..... | A18-53241-000..... | 12 |
| Coolant Tank..... | 603-5601..... | 15161670..... | 21 | Handle, Exterior..... | 760-5401..... | 2008179L..... | 15 |
| Coolant Tank..... | 603-5603..... | 8972230122..... | 22 | Handle, Exterior..... | 760-5402..... | 2008179R..... | 15 |
| Coolant Tank Cap..... | 902-5101..... | 2039390C3..... | 25 | Handle, Exterior..... | 760-5403..... | R56-1025..... | 14 |
| Coolant Tank Cap..... | 902-5102..... | 3578833C3..... | 25 | Handle, Exterior..... | 760-5403..... | R56-1025..... | 15 |
| Coolant Tank Cap..... | 902-5201..... | 05-20763-001..... | 24 | Handle, Exterior..... | 760-5404..... | K294-411PAK..... | 14 |
| Coolant Tank Cap..... | 902-5202..... | 05-17223-002..... | 25 | Handle, Exterior..... | 760-5405..... | K294-411RPAK..... | 14 |
| Coolant Tank Cap..... | 902-5402..... | N5348001..... | 26 | Handle, Exterior..... | 760-5408..... | R56-1025R..... | 14 |
| Coolant Tank Cap..... | 902-5403..... | R00050..... | 26 | Handle, Exterior..... | 760-5408..... | R56-1025R..... | 15 |
| Coolant Tank Cap..... | 902-5502..... | 5481-9916238..... | 26 | Handle, Exterior..... | 760-5501..... | 25192012..... | 14 |
| Coolant Tank Cap..... | 902-5601..... | 15075118..... | 25 | Handle, Exterior..... | 760-5502..... | 25191926..... | 15 |
| Coolant Tank Cap..... | 902-5601..... | 15075118..... | 25 | Handle, Exterior..... | 760-5601..... | 8-97867-721-1..... | 14 |
| Coolant Tube..... | 936-5201..... | A05-16380-003..... | 5 | Handle, Exterior..... | 760-5602..... | 8-97867-722-1..... | 14 |
| Coolant Tube..... | 936-5202..... | A05-16384-001..... | 5 | Handle, Exterior..... | 760-5603..... | 15619625..... | 12 |
| Coolant Tube..... | 936-5401..... | 07-06464..... | 6 | Handle, Exterior..... | 760-5604..... | 15619624..... | 13 |
| Coolant Tube..... | 936-5402..... | 07-06462..... | 6 | Handle, Interior..... | 761-5103..... | 2505425C1..... | 16 |
| Coolant Tube..... | 936-5403..... | K181-5141..... | 5 | Handle, Interior..... | 761-5104..... | 2505424C1..... | 16 |
| Coolant Tube..... | 936-5404..... | K181-5483..... | 5 | Handle, Interior..... | 761-5406..... | K294-426PAK..... | 16 |
| Coolant Tube..... | 936-5405..... | K181-5597..... | 6 | Handle, Interior..... | 761-5407..... | K294-426RPAK..... | 16 |
| Coolant Tube..... | 936-5501..... | 20561364..... | 6 | Headlight..... | 888-5101..... | 3605817C92..... | 43 |
| Coolant Tube..... | 936-5502..... | 20357260..... | 7 | Headlight..... | 888-5102..... | 3605816C92..... | 43 |
| D | | | | Headlight..... | 888-5103..... | 3502929C94..... | 43 |
| DEF Cap..... | 904-5201..... | 04-27757-000..... | 38 | Headlight..... | 888-5104..... | 3502928C94..... | 43 |
| DEF Cap..... | 904-5301..... | AU5Z5K204A..... | 38 | Headlight..... | 888-5105..... | 3574388C91..... | 44 |
| DEF Cap..... | 904-5401..... | 908-0223-01..... | 39 | Headlight..... | 888-5106..... | 3574387C91..... | 44 |
| DEF Cap..... | 904-5401..... | 908-0223-01..... | 39 | Headlight Screw..... | 924-5104..... | 500565C91..... | 44 |
| DEF Cap..... | 904-5501..... | 21148728..... | 39 | Headlight Switch..... | 901-5206..... | A06-30769-010..... | 45 |
| DEF Cap..... | 904-5502..... | 21148725..... | 39 | Heater Hose Connector..... | 800-401..... | 15622861..... | 7 |
| DEF Cap..... | 904-5601..... | 22753134..... | 38 | Hood Cable..... | 924-5206..... | A17-12082-000..... | 53 |
| DEF Cap..... | 904-5701..... | 52122496AD..... | 38 | Hood Cable..... | 924-5207..... | A17-12081-000..... | 53 |
| Door Check Kit..... | 924-5401..... | 20-11525M001..... | 17 | Hood Cable..... | 924-5402..... | L92-6000-0718..... | 54 |
| Door Check Kit..... | 924-5401..... | 20-12066..... | 17 | Hood Cable..... | 924-5501..... | 25152850..... | 54 |
| Door Check Kit..... | 924-5401..... | 20-18727..... | 17 | Hood Cable..... | 924-5502..... | 25171452..... | 54 |
| Door Check Kit..... | 924-5401..... | R65-6019..... | 17 | Hood Latch Kit..... | 315-5101..... | 1699929C9..... | 51 |
| Door Hinge..... | 924-5103..... | 3549259C1..... | 17 | Hood Latch Kit..... | 315-5101..... | 499523C3..... | 51 |
| Door Hinge..... | 924-5603..... | 8-97852-007-3..... | 17 | Hood Latch Kit..... | 315-5201..... | 17-12348-000..... | 50 |
| F | | | | Hood Latch Kit..... | 315-5202..... | A17-15553-001..... | 50 |
| Fog Light..... | 924-5201..... | A06-75742-000..... | 44 | Hood Latch Kit..... | 315-5203..... | A17-15553-000..... | 51 |
| Fuel Senders..... | 285-5101..... | 2585993C91..... | 33 | Hood Latch Kit..... | 315-5204..... | 17-12435-001..... | 51 |
| Fuel Senders..... | 285-5103..... | 3596382C92..... | 33 | Hood Latch Kit..... | 315-5205..... | 17-12435-000..... | 51 |
| Fuel Senders..... | 285-5104..... | 476846C2..... | 33 | Hood Latch Kit..... | 315-5401..... | 1699929C9..... | 52 |
| Fuel Senders..... | 285-5105..... | 497840C96..... | 34 | Hood Latch Kit..... | 315-5401..... | 1699929C9..... | 53 |
| Fuel Senders..... | 285-5203..... | A22-42390-005..... | 33 | Hood Latch Kit..... | 315-5401..... | L56-0001..... | 52 |
| Fuel Senders..... | 285-5401..... | K21-6001-661..... | 37 | Hood Latch Kit..... | 315-5401..... | L56-0001..... | 53 |
| Fuel Senders..... | 285-5402..... | K21-6001-585..... | 37 | Hood Latch Kit..... | 315-5402..... | K147-107..... | 52 |
| Fuel Senders..... | 285-5403..... | 391PLP..... | 37 | Hood Latch Kit..... | 315-5501..... | 8174018..... | 53 |
| Fuel Senders..... | 285-5404..... | Q21-1024-622..... | 34 | Hood Latch Kit..... | 315-5502..... | 25169065..... | 52 |
| Fuel Senders..... | 285-5405..... | Q21-1024-559..... | 34 | Hood Latch Kit..... | 315-5503..... | 25159428..... | 52 |
| Fuel Senders..... | 285-5406..... | Q21-1043-622..... | 34 | Hood Rest..... | 924-5202..... | A17-13787-002..... | 54 |
| Fuel Senders..... | 285-5501..... | 20506805..... | 35 | Hood Rest..... | 924-5203..... | A17-13787-003..... | 54 |
| Fuel Senders..... | 285-5502..... | 25172994..... | 35 | Hood Spring..... | 938-5101..... | 1675762C3..... | 47 |
| Fuel Senders..... | 285-5503..... | 16MB48DP13..... | 35 | Hood Spring..... | 938-5102..... | 3588532C2..... | 47 |
| Fuel Senders..... | 285-5504..... | 25172995..... | 35 | Hood Spring..... | 938-5103..... | 598574C3..... | 47 |
| Fuel Senders..... | 285-5505..... | 16MB48DP29..... | 36 | Hood Spring..... | 938-5201..... | 17-12069-001..... | 47 |
| Fuel Senders..... | 285-5506..... | 25101400..... | 36 | Hood Spring..... | 938-5401..... | L71-1002..... | 48 |
| Fuel Senders..... | 285-5507..... | 25195325..... | 36 | Hood Spring..... | 938-5402..... | K224-95..... | 48 |
| Fuel Senders..... | 285-5508..... | 8609-NC2759..... | 36 | Hood Spring..... | 938-5403..... | K224-86..... | 48 |
| Fuel Senders..... | 285-5509..... | 3092993..... | 37 | Hood Spring..... | 938-5404..... | K224-35..... | 48 |
| H | | | | Hood Spring..... | 938-5405..... | L71-1004..... | 49 |
| Handle, Exterior..... | 760-5101..... | 3550931C91..... | 13 | Hood Spring..... | 938-5406..... | 13-04638..... | 50 |
| | | | | Hood Spring..... | 938-5407..... | 13-03569..... | 50 |
| | | | | Hood Spring..... | 938-5408..... | K224-81..... | 49 |
| | | | | Hood Spring..... | 938-5501..... | 25171284..... | 49 |
| | | | | Hood Spring..... | 938-5502..... | 25158019..... | 49 |
| | | | | HVAC Knob Kit..... | 702-5401..... | 121-0001-000..... | 8 |
| | | | | HVAC Knob Kit..... | 702-5402..... | FD1240..... | 7 |

Alphabetical Interchange By Part Type

Intercambio alfabético por el tipo de pieza

| Part Type | Dorman No. | OE No. | Page No. |
|---------------------------------------|------------|---------------|----------|
| I | | | |
| Instrument Cluster..... | 599-5101 | 3525091C91 | 73 |
| Instrument Cluster..... | 599-5102 | 3595124C2 | 73 |
| M | | | |
| Mirror Bracket..... | 924-5105 | 2597071C91 | 18 |
| Mirror Bracket..... | 924-5106 | 2597075C91 | 18 |
| Mirror Motor..... | 924-5204 | 28569 | 18 |
| Mirror Switch..... | 901-5201 | 34103PF | 18 |
| Multi-Function Switch..... | 978-5101 | 2502912C91 | 74 |
| Multi-Function Switch..... | 978-5201 | A06-36956-002 | 73 |
| O | | | |
| Oil Cooler Line..... | 625-185 | 15791673 | 28 |
| Oil Cooler Line..... | 625-187 | 15791675 | 29 |
| Oil Cooler Line..... | 625-188 | 93440852 | 29 |
| Oil Cooler Line..... | 625-189 | 93440853 | 29 |
| Oil Cooler Line..... | 625-190 | 15022583 | 29 |
| Oil Cooler Line..... | 625-191 | 15149877 | 30 |
| Oil Cooler Line..... | 625-192 | 15022583 | 30 |
| Oil Cooler Line..... | 625-193 | 15149878 | 31 |
| Oil Cooler Line..... | 625-194 | 15028506 | 31 |
| Oil Cooler Line..... | 625-195 | 15706746 | 30 |
| Oil Cooler Line..... | 625-196 | 15706745 | 30 |
| Oil Cooler Line..... | 625-250 | F5HZ6A715AA | 28 |
| Oil Cooler Line..... | 625-251 | F5HZ6A715BA | 28 |
| Oil Cooler Line Connector..... | 800-707 | 15170197 | 31 |
| Oil Cooler Line Connector..... | 800-707 | 15797464 | 31 |
| P | | | |
| Power Steering Pump Pulley..... | 300-120 | 2477954 | 31 |
| R | | | |
| Radiator Fan Assembly..... | 620-5601 | 8-97383-808-0 | 8 |
| S | | | |
| Shift Boot..... | 924-5405 | K042-79 | 18 |
| Speed Sensor..... | 505-5104 | 2503117C1 | 57 |
| Speed Sensor..... | 505-5105 | 3528003C1 | 57 |
| Speed Sensor..... | 505-5201 | SAA85920008 | 57 |
| Speed Sensor..... | 505-5505 | 25166488 | 57 |
| Speed Sensor..... | 505-5510 | 8029939 | 58 |
| Speed Sensor..... | 505-5512 | 20706327 | 58 |
| Speed Sensor & Tachometer Sensor..... | 505-5406 | Q21-6005 | 59 |
| Speed Sensor & Tachometer Sensor..... | 505-5406 | Q21-6005 | 59 |
| Speed Sensor & Tachometer Sensor..... | 505-5407 | K3454 | 59 |
| Speed Sensor & Tachometer Sensor..... | 505-5407 | K3454 | 60 |
| Speed Sensor & Tachometer Sensor..... | 505-5408 | K3455 | 60 |
| Speed Sensor & Tachometer Sensor..... | 505-5408 | K3455 | 61 |
| Speed Sensor & Tachometer Sensor..... | 505-5507 | 64MT412M | 60 |
| T | | | |
| Tachometer Sensor..... | 505-5501 | 64MT2105M | 58 |
| Tachometer Sensor..... | 505-5504 | 64MT435 | 58 |
| Tachometer Sensor..... | 505-5506 | 64MT440M | 59 |
| Tachometer Sensor..... | 505-5511 | 8078108 | 59 |
| Transfer Case Motor 4WD..... | 600-909 | 88962312 | 61 |
| W | | | |
| Washer Tank..... | 603-5401 | K114-20 | 23 |
| Washer Tank..... | 603-5402 | N5355001 | 24 |
| Washer Tank..... | 603-5404 | R86-6001 | 24 |
| Washer Tank..... | 603-5503 | 25128217 | 23 |
| Washer Tank..... | 603-5602 | 8978550656 | 23 |
| Washer Tank Cap..... | 902-5401 | 25171612 | 27 |
| Washer Tank Cap..... | 902-5401 | C5720S | 27 |
| Washer Tank Cap..... | 902-5404 | 3150-063415A | 26 |
| Washer Tank Cap..... | 902-5404 | 63361 | 28 |
| Washer Tank Cap..... | 902-5404 | FLM63361 | 27 |
| Window Lift Motor Kit..... | 742-142 | 10414628 | 71 |

| Part Type | Dorman No. | OE No. | Page No. |
|-------------------------------|------------|----------------|----------|
| W (Cont'd) | | | |
| Window Lift Motor Kit..... | 742-142 | 10414630 | 71 |
| Window Lift Motor Kit..... | 742-142 | 10414632 | 71 |
| Window Lift Motor Kit..... | 742-142 | 15221956 | 71 |
| Window Lift Motor Kit..... | 742-142 | 16630577 | 71 |
| Window Lift Motor Kit..... | 742-142 | 16630579 | 71 |
| Window Lift Motor Kit..... | 742-142 | 21096870 | 71 |
| Window Lift Motor Kit..... | 742-142 | 21170781 | 71 |
| Window Lift Motor Kit..... | 742-142 | 21171231 | 71 |
| Window Lift Motor Kit..... | 742-142 | 21171235 | 71 |
| Window Lift Motor Kit..... | 742-142 | 22143945 | 71 |
| Window Lift Motor Kit..... | 742-142 | 22143947 | 71 |
| Window Lift Motor Kit..... | 742-142 | 22154977 | 71 |
| Window Lift Motor Kit..... | 742-142 | 22154979 | 71 |
| Window Lift Motor Kit..... | 742-143 | 10414629 | 71 |
| Window Lift Motor Kit..... | 742-143 | 10414631 | 71 |
| Window Lift Motor Kit..... | 742-143 | 10414633 | 71 |
| Window Lift Motor Kit..... | 742-143 | 15221951 | 71 |
| Window Lift Motor Kit..... | 742-143 | 16628208 | 71 |
| Window Lift Motor Kit..... | 742-143 | 16630576 | 71 |
| Window Lift Motor Kit..... | 742-143 | 16630578 | 71 |
| Window Lift Motor Kit..... | 742-143 | 21096871 | 71 |
| Window Lift Motor Kit..... | 742-143 | 21170780 | 71 |
| Window Lift Motor Kit..... | 742-143 | 21171230 | 71 |
| Window Lift Motor Kit..... | 742-143 | 21171234 | 71 |
| Window Lift Motor Kit..... | 742-143 | 22063224 | 71 |
| Window Lift Motor Kit..... | 742-143 | 22143946 | 71 |
| Window Lift Motor Kit..... | 742-143 | 22143948 | 71 |
| Window Lift Motor Kit..... | 742-143 | 22154978 | 71 |
| Window Lift Motor Kit..... | 742-143 | 22154980 | 71 |
| Window Regulator; Manual..... | 740-5103 | 1686705C91 | 64 |
| Window Regulator; Manual..... | 740-5104 | 1686704C91 | 64 |
| Window Regulator; Manual..... | 740-5501 | 25191027 | 64 |
| Window Regulator; Manual..... | 740-5502 | 25191633 | 64 |
| Window Regulator; Manual..... | 740-5503 | 25113357 | 65 |
| Window Regulator; Manual..... | 740-5504 | 25114490 | 65 |
| Window Regulator; Manual..... | 740-5505 | 25161668 | 65 |
| Window Regulator; Manual..... | 740-5506 | 25160158 | 65 |
| Window Regulator; Manual..... | 740-5507 | 25169077 | 66 |
| Window Regulator; Manual..... | 740-5508 | 25169076 | 66 |
| Window Regulator; Manual..... | 740-652 | E7T21523200A | 63 |
| Window Regulator; Manual..... | 740-653 | E7T21523201A | 63 |
| Window Regulator; Manual..... | 749-075 | 22071951 | 63 |
| Window Regulator; Manual..... | 749-076 | 22071950 | 63 |
| Window Regulator; Power..... | 741-5101 | 3515113C92 | 69 |
| Window Regulator; Power..... | 741-5102 | 3515112C92 | 69 |
| Window Regulator; Power..... | 741-5201 | A18-48952-001 | 67 |
| Window Regulator; Power..... | 741-5202 | A18-48952-000 | 67 |
| Window Regulator; Power..... | 741-5203 | A18-52044-001 | 68 |
| Window Regulator; Power..... | 741-5204 | A18-52044-000 | 68 |
| Window Regulator; Power..... | 741-5401 | R21-6011 | 70 |
| Window Regulator; Power..... | 741-5402 | R21-6011R | 70 |
| Window Regulator; Power..... | 741-5403 | R21-1005 | 69 |
| Window Regulator; Power..... | 741-5404 | R21-1005R | 69 |
| Window Regulator; Power..... | 741-5405 | R21-6013 | 70 |
| Window Regulator; Power..... | 741-5406 | R21-6013R | 70 |
| Window Regulator; Power..... | 741-654 | 22071948 | 68 |
| Window Regulator; Power..... | 741-655 | 22071949 | 68 |
| Window Regulator; Power..... | 748-180 | 8C3Z2523201C | 66 |
| Window Regulator; Power..... | 748-181 | 8C3Z2523200C | 66 |
| Window Regulator; Power..... | 748-212 | 1C3Z2523201BA | 67 |
| Window Regulator; Power..... | 748-213 | 1C3Z2523200BA | 67 |
| Window Switch..... | 901-5204 | A06-30769-008 | 71 |
| Window Switch..... | 901-5205 | A06-307 69-027 | 71 |
| Wiper Nozzle Kit..... | 924-5101 | 1696499C1 | 74 |
| Wiper Nozzle Kit..... | 924-5403 | 106.811 | 74 |
| Wiper Transmission..... | 602-5601 | 8-94165-462-1 | 73 |
| Wiper Transmission..... | 602-5601 | 8-97855-152-0 | 73 |
| Wiper Transmission..... | 602-5601 | 8-97855-154-0 | 73 |

OE to Dorman Interchange

De equipo original a Intercambio de Dorman

| Make | OE No. | Dorman No. | Page No. | Make | OE No. | Dorman No. | Page No. |
|---|---------------|------------|----------|---|---------------|------------|----------|
| Coolant Tubes, Heating and Cooling | | | | Fluid Reservoirs and Engine Parts (Cont'd) | | | |
| Freightliner | A05-16380-003 | 936-5201 | 5 | GMC | 15797464 | 800-707 | 31 |
| Freightliner | A05-16384-001 | 936-5202 | 5 | GMC | 15706745 | 625-196 | 30 |
| GMC | 15622861 | 800-401 | 7 | GMC | 15706746 | 625-195 | 30 |
| International | 3542606C1 | 604-5101 | 7 | GMC | 15791673 | 625-185 | 28 |
| Isuzu | 8-97383-808-0 | 620-5601 | 8 | GMC | 15791675 | 625-187 | 29 |
| Kenworth | FD1240 | 702-5402 | 7 | GMC | 2477954 | 300-120 | 31 |
| Kenworth | K181-5141 | 936-5403 | 5 | GMC | 93440852 | 625-188 | 29 |
| Kenworth | K181-5483 | 936-5404 | 5 | GMC | 93440853 | 625-189 | 29 |
| Kenworth | K181-5597 | 936-5405 | 6 | GMC | 15075118 | 902-5601 | 25 |
| Peterbilt | 07-06462 | 936-5402 | 6 | International | 2002105C3 | 603-5101 | 21 |
| Peterbilt | 07-06464 | 936-5401 | 6 | International | 2039390C3 | 902-5101 | 25 |
| Peterbilt | 121-0001-000 | 702-5401 | 8 | International | 2508700C92 | 603-5103 | 22 |
| Volvo | 20357260 | 936-5502 | 7 | International | 3578833C3 | 902-5102 | 25 |
| Volvo | 20561364 | 936-5501 | 6 | Isuzu | 8972230122 | 603-5603 | 22 |
| Door Handles and Body Parts | | | | Isuzu | 8978550656 | 603-5602 | 23 |
| Freightliner | 28569 | 924-5204 | 18 | Kenworth | C57205 | 902-5401 | 27 |
| Freightliner | 34103PF | 901-5201 | 18 | Kenworth | K114-20 | 603-5401 | 23 |
| Freightliner | A18-35381-000 | 760-5205 | 12 | Mack | 25128217 | 603-5503 | 23 |
| Freightliner | A18-35381-001 | 760-5206 | 12 | Mack | 25133601 | 603-5501 | 23 |
| Freightliner | A18-42228-000 | 760-5203 | 11 | Mack | 25174629 | 603-5502 | 22 |
| Freightliner | A18-42228-001 | 760-5204 | 11 | Mack | 5481-9916238 | 902-5502 | 26 |
| Freightliner | A18-42228-002 | 760-5202 | 11 | Mack | 3150063415A | 902-5404 | 26 |
| Freightliner | A18-42228-003 | 760-5201 | 11 | Mack | 25171612 | 902-5401 | 27 |
| Freightliner | A18-53241-000 | 760-5208 | 12 | Peterbilt | 63361 | 902-5404 | 28 |
| Freightliner | A18-47729-002 | 760-5208 | 12 | Peterbilt | N5346001 | 603-5403 | 23 |
| Freightliner | A18-47729-003 | 760-5207 | 12 | Peterbilt | N5348001 | 902-5402 | 26 |
| Freightliner | A18-53241-001 | 760-5207 | 12 | Peterbilt | N5355001 | 603-5402 | 24 |
| GMC | 15619624 | 760-5604 | 13 | Peterbilt | R86-6001 | 603-5404 | 24 |
| GMC | 15619625 | 760-5603 | 12 | Peterbilt | RC0050 | 902-5403 | 26 |
| GMC | 3920296 | 20759 | 17 | Fuel Senders, Fuel and Emissions | | | |
| International | 2505424C1 | 761-5104 | 16 | Dodge | 52122496AD | 904-5701 | 38 |
| International | 2505425C1 | 761-5103 | 16 | Ford | AU5Z5K204A | 904-5301 | 38 |
| International | 2594003C1 | 760-5106 | 13 | Freightliner | 04-27757-000 | 904-5201 | 38 |
| International | 2594006C1 | 760-5105 | 13 | Freightliner | A22-42390-005 | 285-5203 | 33 |
| International | 2597071C91 | 924-5105 | 18 | GM | 22753134 | 904-5601 | 38 |
| International | 2597075C91 | 924-5106 | 18 | International | 2585993C91 | 285-5101 | 33 |
| International | 3549259C1 | 924-5103 | 17 | International | 3596382C92 | 285-5103 | 33 |
| International | 3550931C91 | 760-5101 | 13 | International | 476846C2 | 285-5104 | 33 |
| Isuzu | 8-97852-007-3 | 924-5603 | 17 | International | 497840C96 | 285-5105 | 34 |
| Isuzu | 8-97867-721-1 | 760-5601 | 14 | Kenworth | 908-0223-01 | 904-5401 | 39 |
| Isuzu | 8-97867-722-1 | 760-5602 | 14 | Kenworth | Q21-1024-559 | 285-5405 | 34 |
| Kenworth | K042-79 | 924-5405 | 18 | Kenworth | Q21-1024-622 | 285-5404 | 34 |
| Kenworth | K294-411PAK | 760-5404 | 14 | Kenworth | Q21-1043-622 | 285-5406 | 34 |
| Kenworth | K294-411RPAK | 760-5405 | 14 | Mack | 16MB48DP13 | 285-5503 | 35 |
| Kenworth | K294-426PAK | 761-5406 | 16 | Mack | 16MB48DP29 | 285-5505 | 36 |
| Kenworth | K294-426RPAK | 761-5407 | 16 | Mack | 20506805 | 285-5501 | 35 |
| Kenworth | R56-1025 | 760-5403 | 14 | Mack | 21148728 | 904-5501 | 39 |
| Kenworth | R56-1025R | 760-5408 | 14 | Mack | 25101400 | 285-5506 | 36 |
| Mack | 25191926 | 760-5502 | 15 | Mack | 25172994 | 285-5502 | 35 |
| Mack | 25192012 | 760-5501 | 14 | Mack | 25172995 | 285-5504 | 35 |
| Peterbilt | 2008179L | 760-5401 | 15 | Mack | 25195325 | 285-5507 | 36 |
| Peterbilt | 2008179R | 760-5402 | 15 | Mack | 8609-NC2759 | 285-5508 | 36 |
| Peterbilt | R56-1025 | 760-5403 | 15 | Peterbilt | 391PLP | 285-5403 | 37 |
| Peterbilt | R56-1025R | 760-5408 | 15 | Peterbilt | 908-0223-01 | 904-5401 | 39 |
| Peterbilt | 20-12066 | 924-5401 | 17 | Peterbilt | K21-6001-585 | 285-5402 | 37 |
| Peterbilt | 20-18727 | 924-5401 | 17 | Peterbilt | K21-6001-661 | 285-5401 | 37 |
| Peterbilt | R65-6019 | 924-5401 | 17 | Volvo | 21148725 | 904-5502 | 39 |
| Peterbilt | 20-11525M001 | 924-5401 | 17 | Volvo | 3092993 | 285-5509 | 37 |
| Fluid Reservoirs and Engine Parts | | | | Headlights and Lighting | | | |
| Ford | F5HZ6A715AA | 625-250 | 28 | Freightliner | A06-30769-010 | 901-5206 | 45 |
| Ford | F5HZ6A715BA | 625-251 | 28 | Freightliner | A06-75742-000 | 924-5201 | 44 |
| Freightliner | 05-17223-002 | 902-5202 | 25 | International | 3502928C94 | 888-5104 | 43 |
| Freightliner | 05-20763-001 | 902-5201 | 24 | International | 3502929C94 | 888-5103 | 43 |
| Freightliner | 05-23045-000 | 603-5201 | 21 | International | 3574387C91 | 888-5106 | 44 |
| Freightliner | 05-23195-000 | 603-5202 | 21 | International | 3574388C91 | 888-5105 | 44 |
| Freightliner | 06-62384-002 | 924-5205 | 24 | International | 3605816C92 | 888-5102 | 43 |
| Freightliner | FLM63361 | 902-5404 | 27 | International | 3605817C92 | 888-5101 | 43 |
| GMC | 15022583 | 625-190 | 29 | International | 500565C91 | 924-5104 | 44 |
| GMC | 15022583 | 625-192 | 30 | Hood Springs, Latches and Components | | | |
| GMC | 15028506 | 625-194 | 31 | Freightliner | 17-12348-000 | 315-5201 | 50 |
| GMC | 15075118 | 902-5601 | 25 | Freightliner | 17-12435-000 | 315-5205 | 51 |
| GMC | 15149877 | 625-191 | 30 | Freightliner | 17-12435-001 | 315-5204 | 51 |
| GMC | 15149878 | 625-193 | 31 | Freightliner | 17-12069-001 | 938-5201 | 47 |
| GMC | 15161670 | 603-5601 | 21 | Freightliner | A17-12081-000 | 924-5207 | 53 |
| GMC | 15170197 | 800-707 | 31 | | | | |

OE to Dorman Interchange

De equipo original a Intercambio de Dorman

| Make | OE No. | Dorman No. | Page No. | Make | OE No. | Dorman No. | Page No. |
|--|---------------|------------|----------|--|---------------|------------|----------|
| Hood Springs, Latches and Components (Cont'd) | | | | Window Regulators and Window Parts (Cont'd) | | | |
| Freightliner | A17-12082-000 | 924-5206 | 53 | GMC | 16630579 | 742-142 | 71 |
| Freightliner | A17-13787-002 | 924-5202 | 54 | GMC | 21096870 | 742-142 | 71 |
| Freightliner | A17-13787-003 | 924-5203 | 54 | GMC | 21096871 | 742-143 | 71 |
| Freightliner | A17-15553-000 | 315-5203 | 51 | GMC | 21170780 | 742-143 | 71 |
| Freightliner | A17-15553-001 | 315-5202 | 50 | GMC | 21170781 | 742-142 | 71 |
| International | 1675762C3 | 938-5101 | 47 | GMC | 21171230 | 742-143 | 71 |
| International | 3588532C2 | 938-5102 | 47 | GMC | 21171231 | 742-142 | 71 |
| International | 499523C3 | 315-5101 | 51 | GMC | 21171234 | 742-143 | 71 |
| International | 1699929C9 | 315-5101 | 51 | GMC | 21171235 | 742-142 | 71 |
| International | 598574C3 | 938-5103 | 47 | GMC | 22063224 | 742-143 | 71 |
| Kenworth | L56-0001 | 315-5401 | 52 | GMC | 22071948 | 741-654 | 68 |
| Kenworth | 1699929C9 | 315-5401 | 52 | GMC | 22071949 | 741-655 | 68 |
| Kenworth | K147-107 | 315-5402 | 52 | GMC | 22071950 | 749-076 | 63 |
| Kenworth | K224-35 | 938-5404 | 48 | GMC | 22071951 | 749-075 | 63 |
| Kenworth | K224-81 | 938-5408 | 49 | GMC | 22143945 | 742-142 | 71 |
| Kenworth | K224-86 | 938-5403 | 48 | GMC | 22143946 | 742-143 | 71 |
| Kenworth | K224-95 | 938-5402 | 48 | GMC | 22143947 | 742-142 | 71 |
| Kenworth | L71-1002 | 938-5401 | 48 | GMC | 22143948 | 742-143 | 71 |
| Kenworth | L71-1004 | 938-5405 | 49 | GMC | 22154977 | 742-142 | 71 |
| Mack | 25152850 | 924-5501 | 54 | GMC | 22154978 | 742-143 | 71 |
| Mack | 25158019 | 938-5502 | 49 | GMC | 22154979 | 742-142 | 71 |
| Mack | 25159428 | 315-5503 | 52 | GMC | 22154980 | 742-143 | 71 |
| Mack | 25169065 | 315-5502 | 52 | International | 1686704C91 | 740-5104 | 64 |
| Mack | 25171284 | 938-5501 | 49 | International | 1686705C91 | 740-5103 | 64 |
| Mack | 25171452 | 924-5502 | 54 | International | 3515112C92 | 741-5102 | 69 |
| Peterbilt | 13-03569 | 938-5407 | 50 | International | 3515113C92 | 741-5101 | 69 |
| Peterbilt | 13-04638 | 938-5406 | 50 | Kenworth | R21-1005 | 741-5403 | 69 |
| Peterbilt | 1699929C9 | 315-5401 | 53 | Kenworth | R21-1005R | 741-5404 | 69 |
| Peterbilt | L56-0001 | 315-5401 | 53 | Mack | 25113357 | 740-5503 | 65 |
| Peterbilt | L92-6000-0718 | 924-5402 | 54 | Mack | 25114490 | 740-5504 | 65 |
| Volvo | 8174018 | 315-5501 | 53 | Mack | 25160158 | 740-5506 | 65 |
| Speed Sensors and Tachometer Sensors | | | | Mack | 25161668 | 740-5505 | 65 |
| Freightliner | SAA85920008 | 505-5201 | 57 | Mack | 25169076 | 740-5508 | 66 |
| GMC | 88962312 | 600-909 | 61 | Mack | 25169077 | 740-5507 | 66 |
| International | 2503117C1 | 505-5104 | 57 | Mack | 25191027 | 740-5501 | 64 |
| International | 3528003C1 | 505-5105 | 57 | Mack | 25191633 | 740-5502 | 64 |
| Kenworth | K3454 | 505-5407 | 59 | Peterbilt | R21-6011 | 741-5401 | 70 |
| Kenworth | K3455 | 505-5408 | 60 | Peterbilt | R21-6011R | 741-5402 | 70 |
| Kenworth | Q21-6005 | 505-5406 | 59 | Peterbilt | R21-6013 | 741-5405 | 70 |
| Mack | 20706327 | 505-5512 | 58 | Peterbilt | R21-6013R | 741-5406 | 70 |
| Mack | 25166488 | 505-5505 | 57 | Wiper Transmissions and Dash Components | | | |
| Mack | 64MT2105M | 505-5501 | 58 | Freightliner | A06-36956-002 | 978-5201 | 73 |
| Mack | 64MT412M | 505-5507 | 60 | International | 1696499C1 | 924-5101 | 74 |
| Mack | 64MT435 | 505-5504 | 58 | International | 2502912C91 | 978-5101 | 74 |
| Mack | 64MT440M | 505-5506 | 59 | International | 3525091C91 | 599-5101 | 73 |
| Peterbilt | K3454 | 505-5407 | 60 | International | 3595124C2 | 599-5102 | 73 |
| Peterbilt | K3455 | 505-5408 | 61 | Isuzu | 8-97855-154-0 | 602-5601 | 73 |
| Peterbilt | Q21-6005 | 505-5406 | 59 | Isuzu | 8-97855-152-0 | 602-5601 | 73 |
| Volvo | 8029939 | 505-5510 | 58 | Isuzu | 8-94165-462-1 | 602-5601 | 73 |
| Volvo | 8078108 | 505-5511 | 59 | Isuzu | 8-94165-540-0 | 602-5601 | 73 |
| Window Regulators and Window Parts | | | | Peterbilt | 106.811 | 924-5403 | 74 |
| Ford | 1C3Z2523200BA | 748-213 | 67 | | | | |
| Ford | 1C3Z2523201BA | 748-212 | 67 | | | | |
| Ford | 8C3Z2523200C | 748-181 | 66 | | | | |
| Ford | 8C3Z2523201C | 748-180 | 66 | | | | |
| Ford | E7TZ1523200A | 740-652 | 63 | | | | |
| Ford | E7TZ1523201A | 740-653 | 63 | | | | |
| Freightliner | A06-30769-008 | 901-5204 | 71 | | | | |
| Freightliner | A06-30769-027 | 901-5205 | 71 | | | | |
| Freightliner | A18-48952-000 | 741-5202 | 67 | | | | |
| Freightliner | A18-48952-001 | 741-5201 | 67 | | | | |
| Freightliner | A18-52044-000 | 741-5204 | 68 | | | | |
| Freightliner | A18-52044-001 | 741-5203 | 68 | | | | |
| GMC | 10414628 | 742-142 | 71 | | | | |
| GMC | 10414629 | 742-143 | 71 | | | | |
| GMC | 10414630 | 742-142 | 71 | | | | |
| GMC | 10414631 | 742-143 | 71 | | | | |
| GMC | 10414632 | 742-142 | 71 | | | | |
| GMC | 10414633 | 742-143 | 71 | | | | |
| GMC | 15221951 | 742-143 | 71 | | | | |
| GMC | 15221956 | 742-142 | 71 | | | | |
| GMC | 16628208 | 742-143 | 71 | | | | |
| GMC | 16630576 | 742-143 | 71 | | | | |
| GMC | 16630577 | 742-142 | 71 | | | | |
| GMC | 16630578 | 742-143 | 71 | | | | |

Interchange By Manufacturer

Intercambio de fabricante

| Make | OE No. | Dorman No. | Page No. | Make | OE No. | Dorman No. | Page No. |
|--------------|---------------|------------|----------|-------------------|------------|------------|----------|
| D | | | | G (Cont'd) | | | |
| Dodge | 52122496AD | 904-5701 | 38 | GMC | 10414632 | 742-142 | 71 |
| F | | | | GMC | 15221956 | 742-142 | 71 |
| Ford | F5HZ6A715AA | 625-250 | 28 | GMC | 16630577 | 742-142 | 71 |
| Ford | F5HZ6A715BA | 625-251 | 28 | GMC | 16630579 | 742-142 | 71 |
| Ford | E7TZ1523200A | 740-652 | 63 | GMC | 21096870 | 742-142 | 71 |
| Ford | E7TZ1523201A | 740-653 | 63 | GMC | 21170781 | 742-142 | 71 |
| Ford | 8C3Z2523201C | 748-180 | 66 | GMC | 21171231 | 742-142 | 71 |
| Ford | 8C3Z2523200C | 748-181 | 66 | GMC | 21171235 | 742-142 | 71 |
| Ford | 1C3Z2523201BA | 748-212 | 67 | GMC | 22143945 | 742-142 | 71 |
| Ford | 1C3Z2523200BA | 748-213 | 67 | GMC | 22143947 | 742-142 | 71 |
| Ford | AU5Z5K204A | 904-5301 | 38 | GMC | 22154977 | 742-142 | 71 |
| Freightliner | A22-42390-005 | 285-5203 | 33 | GMC | 22154979 | 742-142 | 71 |
| Freightliner | 17-12348-000 | 315-5201 | 50 | GMC | 10414629 | 742-143 | 71 |
| Freightliner | A17-15553-001 | 315-5202 | 50 | GMC | 10414631 | 742-143 | 71 |
| Freightliner | A17-15553-000 | 315-5203 | 51 | GMC | 10414633 | 742-143 | 71 |
| Freightliner | 17-12435-001 | 315-5204 | 51 | GMC | 15221951 | 742-143 | 71 |
| Freightliner | 17-12435-000 | 315-5205 | 51 | GMC | 16628208 | 742-143 | 71 |
| Freightliner | SAA85920008 | 505-5201 | 57 | GMC | 16630576 | 742-143 | 71 |
| Freightliner | 05-23045-000 | 603-5201 | 21 | GMC | 16630578 | 742-143 | 71 |
| Freightliner | 05-23195-000 | 603-5202 | 21 | GMC | 21096871 | 742-143 | 71 |
| Freightliner | A18-48952-001 | 741-5201 | 67 | GMC | 21170780 | 742-143 | 71 |
| Freightliner | A18-48952-000 | 741-5202 | 67 | GMC | 21171230 | 742-143 | 71 |
| Freightliner | A18-52044-001 | 741-5203 | 68 | GMC | 21171234 | 742-143 | 71 |
| Freightliner | A18-52044-000 | 741-5204 | 68 | GMC | 22063224 | 742-143 | 71 |
| Freightliner | A18-42228-003 | 760-5201 | 11 | GMC | 22143946 | 742-143 | 71 |
| Freightliner | A18-42228-002 | 760-5202 | 11 | GMC | 22143948 | 742-143 | 71 |
| Freightliner | A18-42228-000 | 760-5203 | 11 | GMC | 22154978 | 742-143 | 71 |
| Freightliner | A18-42228-001 | 760-5204 | 11 | GMC | 22154980 | 742-143 | 71 |
| Freightliner | A18-35381-000 | 760-5205 | 12 | GMC | 22071951 | 749-075 | 63 |
| Freightliner | A18-35381-001 | 760-5206 | 12 | GMC | 22071950 | 749-076 | 63 |
| Freightliner | A18-47729-003 | 760-5207 | 12 | GMC | 15619625 | 760-5603 | 12 |
| Freightliner | A18-53241-001 | 760-5207 | 12 | GMC | 15619624 | 760-5604 | 13 |
| Freightliner | A18-53241-000 | 760-5208 | 12 | GMC | 15622861 | 800-401 | 7 |
| Freightliner | A18-47729-002 | 760-5208 | 12 | GMC | 15170197 | 800-707 | 31 |
| Freightliner | 34103PF | 901-5201 | 18 | GMC | 15797464 | 800-707 | 31 |
| Freightliner | A06-30769-008 | 901-5204 | 71 | GMC | 15075118 | 902-5601 | 25 |
| Freightliner | A06-30769-027 | 901-5205 | 71 | GMC | 15075118 | 902-5601 | 25 |
| Freightliner | A06-30769-010 | 901-5206 | 45 | I | | | |
| Freightliner | 05-20763-001 | 902-5201 | 24 | International | 2585993C91 | 285-5101 | 33 |
| Freightliner | 05-17223-002 | 902-5202 | 25 | International | 3596382C92 | 285-5103 | 33 |
| Freightliner | FLM63361 | 902-5404 | 27 | International | 476846C2 | 285-5104 | 33 |
| Freightliner | 04-27757-000 | 904-5201 | 38 | International | 497840C96 | 285-5105 | 34 |
| Freightliner | A06-75742-000 | 924-5201 | 44 | International | 499523C3 | 315-5101 | 51 |
| Freightliner | A17-13787-002 | 924-5202 | 54 | International | 1699929C9 | 315-5101 | 51 |
| Freightliner | A17-13787-003 | 924-5203 | 54 | International | 2503117C1 | 505-5104 | 57 |
| Freightliner | 28569 | 924-5204 | 18 | International | 3528003C1 | 505-5105 | 57 |
| Freightliner | 06-62384-002 | 924-5205 | 24 | International | 3525091C91 | 599-5101 | 73 |
| Freightliner | A17-12082-000 | 924-5206 | 53 | International | 3595124C2 | 599-5102 | 73 |
| Freightliner | A17-12081-000 | 924-5207 | 53 | International | 2002105C3 | 603-5101 | 21 |
| Freightliner | A05-16380-003 | 936-5201 | 5 | International | 2508700C92 | 603-5103 | 22 |
| Freightliner | A05-16384-001 | 936-5202 | 5 | International | 3542606C1 | 604-5101 | 7 |
| Freightliner | 17-12069-001 | 938-5201 | 47 | International | 1686705C91 | 740-5103 | 64 |
| Freightliner | A06-36956-002 | 978-5201 | 73 | International | 1686704C91 | 740-5104 | 64 |
| G | | | | International | 3515113C92 | 741-5101 | 69 |
| GMC | 22753134 | 904-5601 | 38 | International | 3515112C92 | 741-5102 | 69 |
| GMC | 3920296 | 20759 | 17 | International | 3550931C91 | 760-5101 | 13 |
| GMC | 2477954 | 300-120 | 31 | International | 2594006C1 | 760-5105 | 13 |
| GMC | 88962312 | 600-909 | 61 | International | 2594003C1 | 760-5106 | 13 |
| GMC | 15161670 | 603-5601 | 21 | International | 2505425C1 | 761-5103 | 16 |
| GMC | 15791673 | 625-185 | 28 | International | 2505424C1 | 761-5104 | 16 |
| GMC | 15791675 | 625-187 | 29 | International | 3605817C92 | 888-5101 | 43 |
| GMC | 93440852 | 625-188 | 29 | International | 3605816C92 | 888-5102 | 43 |
| GMC | 93440853 | 625-189 | 29 | International | 3502929C94 | 888-5103 | 43 |
| GMC | 15022583 | 625-190 | 29 | International | 3502928C94 | 888-5104 | 43 |
| GMC | 15149877 | 625-191 | 30 | International | 3574388C91 | 888-5105 | 44 |
| GMC | 15022583 | 625-192 | 30 | International | 3574387C91 | 888-5106 | 44 |
| GMC | 15149878 | 625-193 | 31 | International | 2039390C3 | 902-5101 | 25 |
| GMC | 15028506 | 625-194 | 31 | International | 3578833C3 | 902-5102 | 25 |
| GMC | 15706746 | 625-195 | 30 | International | 1696499C1 | 924-5101 | 74 |
| GMC | 15706745 | 625-196 | 30 | International | 3549259C1 | 924-5103 | 17 |
| GMC | 22071948 | 741-654 | 68 | International | 500565C91 | 924-5104 | 44 |
| GMC | 22071949 | 741-655 | 68 | International | 2597071C91 | 924-5105 | 18 |
| GMC | 10414628 | 742-142 | 71 | International | 2597075C91 | 924-5106 | 18 |
| GMC | 10414630 | 742-142 | 71 | International | 1675762C3 | 938-5101 | 47 |
| | | | | International | 3588532C2 | 938-5102 | 47 |

Interchange By Manufacturer

Intercambio de fabricante

| Make | OE No. | Dorman No. | Page No. |
|-------------------|---------------|------------|----------|
| I (Cont'd) | | | |
| International | 598574C3 | 938-5103 | 47 |
| International | 2502912C91 | 978-5101 | 74 |
| Isuzu | 8-97855-154-0 | 602-5601 | 73 |
| Isuzu | 8-97855-152-0 | 602-5601 | 73 |
| Isuzu | 8-94165-462-1 | 602-5601 | 73 |
| Isuzu | 8978550656 | 603-5602 | 23 |
| Isuzu | 8972230122 | 603-5603 | 22 |
| Isuzu | 8-97383-808-0 | 620-5601 | 8 |
| Isuzu | 8-97867-721-1 | 760-5601 | 14 |
| Isuzu | 8-97867-722-1 | 760-5602 | 14 |
| Isuzu | 8-97852-007-3 | 924-5603 | 17 |
| K | | | |
| Kenworth | Q21-1024-622 | 285-5404 | 34 |
| Kenworth | Q21-1024-559 | 285-5405 | 34 |
| Kenworth | Q21-1043-622 | 285-5406 | 34 |
| Kenworth | L56-0001 | 315-5401 | 52 |
| Kenworth | 1699929C9 | 315-5401 | 52 |
| Kenworth | K147-107 | 315-5402 | 52 |
| Kenworth | Q21-6005 | 505-5406 | 59 |
| Kenworth | K3454 | 505-5407 | 59 |
| Kenworth | K3455 | 505-5408 | 60 |
| Kenworth | K114-20 | 603-5401 | 23 |
| Kenworth | FD1240 | 702-5402 | 7 |
| Kenworth | R21-1005 | 741-5403 | 69 |
| Kenworth | R21-1005R | 741-5404 | 69 |
| Kenworth | R56-1025 | 760-5403 | 14 |
| Kenworth | K294-411PAK | 760-5404 | 14 |
| Kenworth | K294-411RPAK | 760-5405 | 14 |
| Kenworth | R56-1025R | 760-5408 | 14 |
| Kenworth | K294-426PAK | 761-5406 | 16 |
| Kenworth | K294-426RPAK | 761-5407 | 16 |
| Kenworth | C5720S | 902-5401 | 27 |
| Kenworth | 908-0223-01 | 904-5401 | 39 |
| Kenworth | K042-79 | 924-5405 | 18 |
| Kenworth | K181-5141 | 936-5403 | 5 |
| Kenworth | K181-5483 | 936-5404 | 5 |
| Kenworth | K181-5597 | 936-5405 | 6 |
| Kenworth | L71-1002 | 938-5401 | 48 |
| Kenworth | K224-95 | 938-5402 | 48 |
| Kenworth | K224-86 | 938-5403 | 48 |
| Kenworth | K224-35 | 938-5404 | 48 |
| Kenworth | L71-1004 | 938-5405 | 49 |
| Kenworth | K224-81 | 938-5408 | 49 |
| M | | | |
| Mack | 20506805 | 285-5501 | 35 |
| Mack | 25172994 | 285-5502 | 35 |
| Mack | 16MB48DP13 | 285-5503 | 35 |
| Mack | 25172995 | 285-5504 | 35 |
| Mack | 16MB48DP29 | 285-5505 | 36 |
| Mack | 25101400 | 285-5506 | 36 |
| Mack | 25195325 | 285-5507 | 36 |
| Mack | 8609-NC2759 | 285-5508 | 36 |
| Mack | 25169065 | 315-5502 | 52 |
| Mack | 25159428 | 315-5503 | 52 |
| Mack | 64MT2105M | 505-5501 | 58 |
| Mack | 64MT435 | 505-5504 | 58 |
| Mack | 25166488 | 505-5505 | 57 |
| Mack | 64MT440M | 505-5506 | 59 |
| Mack | 64MT412M | 505-5507 | 60 |
| Mack | 20706327 | 505-5512 | 58 |
| Mack | 25133601 | 603-5501 | 22 |
| Mack | 25174629 | 603-5502 | 22 |
| Mack | 25128217 | 603-5503 | 23 |
| Mack | 25191027 | 740-5501 | 64 |
| Mack | 25191633 | 740-5502 | 64 |
| Mack | 25113357 | 740-5503 | 65 |
| Mack | 25114490 | 740-5504 | 65 |
| Mack | 25161668 | 740-5505 | 65 |
| Mack | 25160158 | 740-5506 | 65 |
| Mack | 25169077 | 740-5507 | 66 |
| Mack | 25169076 | 740-5508 | 66 |
| Mack | 25192012 | 760-5501 | 14 |
| Mack | 25191926 | 760-5502 | 15 |
| Mack | 25171612 | 902-5401 | 27 |

| Make | OE No. | Dorman No. | Page No. |
|-------------------|---------------|------------|----------|
| M (Cont'd) | | | |
| Mack | 3150-063415A | 902-5404 | 26 |
| Mack | 5481-9916238 | 902-5502 | 26 |
| Mack | 21148728 | 904-5501 | 39 |
| Mack | 25152850 | 924-5501 | 54 |
| Mack | 25171452 | 924-5502 | 54 |
| Mack | 25171284 | 938-5501 | 49 |
| Mack | 25158019 | 938-5502 | 49 |
| P | | | |
| Peterbilt | K21-6001-661 | 285-5401 | 37 |
| Peterbilt | K21-6001-585 | 285-5402 | 37 |
| Peterbilt | 391PLP | 285-5403 | 37 |
| Peterbilt | 1699929C9 | 315-5401 | 53 |
| Peterbilt | L56-0001 | 315-5401 | 53 |
| Peterbilt | Q21-6005 | 505-5406 | 59 |
| Peterbilt | K3454 | 505-5407 | 60 |
| Peterbilt | K3455 | 505-5408 | 61 |
| Peterbilt | N5355001 | 603-5402 | 24 |
| Peterbilt | N5346001 | 603-5403 | 23 |
| Peterbilt | R86-6001 | 603-5404 | 24 |
| Peterbilt | 121-0001-000 | 702-5401 | 8 |
| Peterbilt | R21-6011 | 741-5401 | 70 |
| Peterbilt | R21-6011R | 741-5402 | 70 |
| Peterbilt | R21-6013 | 741-5405 | 70 |
| Peterbilt | R21-6013R | 741-5406 | 70 |
| Peterbilt | 2008179L | 760-5401 | 15 |
| Peterbilt | 2008179R | 760-5402 | 15 |
| Peterbilt | R56-1025 | 760-5403 | 15 |
| Peterbilt | R56-1025R | 760-5408 | 15 |
| Peterbilt | N5348001 | 902-5402 | 26 |
| Peterbilt | R00050 | 902-5403 | 26 |
| Peterbilt | 63361 | 902-5404 | 28 |
| Peterbilt | 908-0223-01 | 904-5401 | 39 |
| Peterbilt | 20-12066 | 924-5401 | 17 |
| Peterbilt | 20-18727 | 924-5401 | 17 |
| Peterbilt | R65-6019 | 924-5401 | 17 |
| Peterbilt | 20-11525M001 | 924-5401 | 17 |
| Peterbilt | L92-6000-0718 | 924-5402 | 54 |
| Peterbilt | 106.811 | 924-5403 | 74 |
| Peterbilt | 07-06464 | 936-5401 | 6 |
| Peterbilt | 07-06462 | 936-5402 | 6 |
| Peterbilt | 13-04638 | 938-5406 | 50 |
| Peterbilt | 13-03569 | 938-5407 | 50 |
| V | | | |
| Volvo | 3092993 | 285-5509 | 37 |
| Volvo | 8174018 | 315-5501 | 53 |
| Volvo | 8029939 | 505-5510 | 58 |
| Volvo | 8078108 | 505-5511 | 59 |
| Volvo | 21148725 | 904-5502 | 39 |
| Volvo | 20561364 | 936-5501 | 6 |
| Volvo | 20357260 | 936-5502 | 7 |

Interchange By OE Number

Intercambio de equipo original

| OE No. | Make | Dorman No. | Page No. | OE No. | Make | Dorman No. | Page No. |
|---------------|---------------|------------|----------|--------------|---------------|------------|----------|
| 04-27757-000 | Freightliner | 904-5201 | 38 | 21096870 | GMC | 742-142 | 71 |
| 05-17223-002 | Freightliner | 902-5202 | 25 | 21096871 | GMC | 742-143 | 71 |
| 05-20763-001 | Freightliner | 902-5201 | 24 | 21148725 | Volvo | 904-5502 | 39 |
| 05-23045-000 | Freightliner | 603-5201 | 21 | 21148728 | Mack | 904-5501 | 39 |
| 05-23195-000 | Freightliner | 603-5202 | 21 | 21170780 | GMC | 742-143 | 71 |
| 06-62384-002 | Freightliner | 924-5205 | 24 | 21170781 | GMC | 742-142 | 71 |
| 07-06462 | Peterbilt | 936-5402 | 6 | 21171230 | GMC | 742-143 | 71 |
| 07-06464 | Peterbilt | 936-5401 | 6 | 21171231 | GMC | 742-142 | 71 |
| 10414628 | GMC | 742-142 | 71 | 21171234 | GMC | 742-143 | 71 |
| 10414629 | GMC | 742-143 | 71 | 21171235 | GMC | 742-142 | 71 |
| 10414630 | GMC | 742-142 | 71 | 22063224 | GMC | 742-143 | 71 |
| 10414631 | GMC | 742-143 | 71 | 22071948 | GMC | 741-654 | 68 |
| 10414632 | GMC | 742-142 | 71 | 22071949 | GMC | 741-655 | 68 |
| 10414633 | GMC | 742-143 | 71 | 22071950 | GMC | 749-076 | 63 |
| 106.811 | Peterbilt | 924-5403 | 74 | 22071951 | GMC | 749-075 | 63 |
| 121-0001-000 | Peterbilt | 702-5401 | 8 | 22143945 | GMC | 742-142 | 71 |
| 13-03569 | Peterbilt | 938-5407 | 50 | 22143946 | GMC | 742-143 | 71 |
| 13-04638 | Peterbilt | 938-5406 | 50 | 22143947 | GMC | 742-142 | 71 |
| 15022583 | GMC | 625-190 | 29 | 22143948 | GMC | 742-143 | 71 |
| 15022583 | GMC | 625-192 | 30 | 22154977 | GMC | 742-142 | 71 |
| 15028506 | GMC | 625-194 | 31 | 22154978 | GMC | 742-143 | 71 |
| 15075118 | GMC | 902-5601 | 25 | 22154979 | GMC | 742-142 | 71 |
| 15075118 | GMC | 902-5601 | 25 | 22154980 | GMC | 742-143 | 71 |
| 15149877 | GMC | 625-191 | 30 | 22753134 | GM | 904-5601 | 38 |
| 15149878 | GMC | 625-193 | 31 | 2477954 | GMC | 300-120 | 31 |
| 15161670 | GMC | 603-5601 | 21 | 2502912C91 | International | 978-5101 | 74 |
| 15170197 | GMC | 800-707 | 31 | 2503117C1 | International | 505-5104 | 57 |
| 15221951 | GMC | 742-143 | 71 | 2505424C1 | International | 761-5104 | 16 |
| 15221956 | GMC | 742-142 | 71 | 2505425C1 | International | 761-5103 | 16 |
| 15619624 | GMC | 760-5604 | 13 | 2508700C92 | International | 603-5103 | 22 |
| 15619625 | GMC | 760-5603 | 12 | 25101400 | Mack | 285-5506 | 36 |
| 15622861 | GMC | 800-401 | 7 | 25113357 | Mack | 740-5503 | 65 |
| 15706745 | GMC | 625-196 | 30 | 25114490 | Mack | 740-5504 | 65 |
| 15706746 | GMC | 625-195 | 30 | 25128217 | Mack | 603-5503 | 23 |
| 15791673 | GMC | 625-185 | 28 | 25133601 | Mack | 603-5501 | 22 |
| 15791675 | GMC | 625-187 | 29 | 25152850 | Mack | 924-5501 | 54 |
| 15797464 | GMC | 800-707 | 31 | 25158019 | Mack | 938-5502 | 49 |
| 16628208 | GMC | 742-143 | 71 | 25159428 | Mack | 315-5503 | 52 |
| 16630576 | GMC | 742-143 | 71 | 25160158 | Mack | 740-5506 | 65 |
| 16630577 | GMC | 742-142 | 71 | 25161668 | Mack | 740-5505 | 65 |
| 16630578 | GMC | 742-143 | 71 | 25166488 | Mack | 505-5505 | 57 |
| 16630579 | GMC | 742-142 | 71 | 25169065 | Mack | 315-5502 | 52 |
| 1675762C3 | International | 938-5101 | 47 | 25169076 | Mack | 740-5508 | 66 |
| 1686704C91 | International | 740-5104 | 64 | 25169077 | Mack | 740-5507 | 66 |
| 1686705C91 | International | 740-5103 | 64 | 25171284 | Mack | 938-5501 | 49 |
| 1696499C1 | International | 924-5101 | 74 | 25171452 | Mack | 924-5502 | 54 |
| 1699929C9 | International | 315-5101 | 51 | 25171612 | Mack | 902-5401 | 27 |
| 1699929C9 | Kenworth | 315-5401 | 52 | 25172994 | Mack | 285-5502 | 35 |
| 1699929C9 | Peterbilt | 315-5401 | 53 | 25172995 | Mack | 285-5504 | 35 |
| 16MB48DP13 | Mack | 285-5503 | 35 | 25174629 | Mack | 603-5502 | 22 |
| 16MB48DP29 | Mack | 285-5505 | 36 | 25191027 | Mack | 740-5501 | 64 |
| 17-12069-001 | Freightliner | 938-5201 | 47 | 25191633 | Mack | 740-5502 | 64 |
| 17-12348-000 | Freightliner | 315-5201 | 50 | 25191926 | Mack | 760-5502 | 15 |
| 17-12435-000 | Freightliner | 315-5205 | 51 | 25192012 | Mack | 760-5501 | 14 |
| 17-12435-001 | Freightliner | 315-5204 | 51 | 25195325 | Mack | 285-5507 | 36 |
| 1C3Z2523200BA | Ford | 748-213 | 67 | 2585993C91 | International | 285-5101 | 33 |
| 1C3Z2523201BA | Ford | 748-212 | 67 | 2594003C1 | International | 760-5106 | 13 |
| 2002105C3 | International | 603-5101 | 21 | 2594006C1 | International | 760-5105 | 13 |
| 2008179L | Peterbilt | 760-5401 | 15 | 2597071C91 | International | 924-5105 | 18 |
| 2008179R | Peterbilt | 760-5402 | 15 | 2597075C91 | International | 924-5106 | 18 |
| 20-11525M001 | Peterbilt | 924-5401 | 17 | 28569 | Freightliner | 924-5204 | 18 |
| 20-12066 | Peterbilt | 924-5401 | 17 | 3092993 | Volvo | 285-5509 | 37 |
| 20-18727 | Peterbilt | 924-5401 | 17 | 3150-063415A | Mack | 902-5404 | 26 |
| 20357260 | Volvo | 936-5502 | 7 | 34103PF | Freightliner | 901-5201 | 18 |
| 2039390C3 | International | 902-5101 | 25 | 3502928C94 | International | 888-5104 | 43 |
| 20506805 | Mack | 285-5501 | 35 | 3502929C94 | International | 888-5103 | 43 |
| 20561364 | Volvo | 936-5501 | 6 | 3515112C92 | International | 741-5102 | 69 |
| 20706327 | Mack | 505-5512 | 58 | 3515113C92 | International | 741-5101 | 69 |

Interchange By OE Number

Intercambio de equipo original

| OE No. | Make | Dorman No. | Page No. | OE No. | Make | Dorman No. | Page No. |
|----------------|---------------|------------|----------|---------------|--------------|------------|----------|
| 3525091C91 | International | 599-5101 | 73 | A18-47729-003 | Freightliner | 760-5207 | 12 |
| 3528003C1 | International | 505-5105 | 57 | A18-48952-000 | Freightliner | 741-5202 | 67 |
| 3542606C1 | International | 604-5101 | 7 | A18-48952-001 | Freightliner | 741-5201 | 67 |
| 3549259C1 | International | 924-5103 | 17 | A18-52044-000 | Freightliner | 741-5204 | 68 |
| 3550931C91 | International | 760-5101 | 13 | A18-52044-001 | Freightliner | 741-5203 | 68 |
| 3574387C91 | International | 888-5106 | 44 | A18-53241-000 | Freightliner | 760-5208 | 12 |
| 3574388C91 | International | 888-5105 | 44 | A18-53241-001 | Freightliner | 760-5207 | 12 |
| 3578833C3 | International | 902-5102 | 25 | A22-42390-005 | Freightliner | 285-5203 | 33 |
| 3588532C2 | International | 938-5102 | 47 | AU5Z5K204A | Ford | 904-5301 | 38 |
| 3595124C2 | International | 599-5102 | 73 | C5720S | Kenworth | 902-5401 | 27 |
| 3596382C92 | International | 285-5103 | 33 | E7TZ1523200A | Ford | 740-652 | 63 |
| 3605816C92 | International | 888-5102 | 43 | E7TZ1523201A | Ford | 740-653 | 63 |
| 3605817C92 | International | 888-5101 | 43 | F5HZ6A715AA | Ford | 625-250 | 28 |
| 391PLP | Peterbilt | 285-5403 | 37 | F5HZ6A715BA | Ford | 625-251 | 28 |
| 3920296 | GMC | 20759 | 17 | FD1240 | Kenworth | 702-5402 | 7 |
| 476846C2 | International | 285-5104 | 33 | FLM63361 | Freightliner | 902-5404 | 27 |
| 497840C96 | International | 285-5105 | 34 | K042-79 | Kenworth | 924-5405 | 18 |
| 499523C3 | International | 315-5101 | 51 | K114-20 | Kenworth | 603-5401 | 23 |
| 500565C91 | International | 924-5104 | 44 | K147-107 | Kenworth | 315-5402 | 52 |
| 52122496AD | Dodge | 904-5701 | 38 | K181-5141 | Kenworth | 936-5403 | 5 |
| 5481-9916238 | Mack | 902-5502 | 26 | K181-5483 | Kenworth | 936-5404 | 5 |
| 598574C3 | International | 938-5103 | 47 | K181-5597 | Kenworth | 936-5405 | 6 |
| 63361 | Peterbilt | 902-5404 | 28 | K21-6001-585 | Peterbilt | 285-5402 | 37 |
| 64MT2105M | Mack | 505-5501 | 58 | K21-6001-661 | Peterbilt | 285-5401 | 37 |
| 64MT412M | Mack | 505-5507 | 60 | K224-35 | Kenworth | 938-5404 | 48 |
| 64MT435 | Mack | 505-5504 | 58 | K224-81 | Kenworth | 938-5408 | 49 |
| 64MT440M | Mack | 505-5506 | 59 | K224-86 | Kenworth | 938-5403 | 48 |
| 8029939 | Volvo | 505-5510 | 58 | K224-95 | Kenworth | 938-5402 | 48 |
| 8078108 | Volvo | 505-5511 | 59 | K294-411PAK | Kenworth | 760-5404 | 14 |
| 8174018 | Volvo | 315-5501 | 53 | K294-411RPAK | Kenworth | 760-5405 | 14 |
| 8609-NC2759 | Mack | 285-5508 | 36 | K294-426PAK | Kenworth | 761-5406 | 16 |
| 88962312 | GMC | 600-909 | 61 | K294-426RPAK | Kenworth | 761-5407 | 16 |
| 8-94165-462-1 | Isuzu | 602-5601 | 73 | K3454 | Kenworth | 505-5407 | 59 |
| 8-94165-540-0 | Isuzu | 602-5601 | 73 | K3454 | Peterbilt | 505-5407 | 60 |
| 8972230122 | Isuzu | 603-5603 | 22 | K3455 | Kenworth | 505-5408 | 60 |
| 8-97383-808-0 | Isuzu | 620-5601 | 8 | K3455 | Peterbilt | 505-5408 | 61 |
| 8-97852-007-3 | Isuzu | 924-5603 | 17 | L56-0001 | Kenworth | 315-5401 | 52 |
| 8978550656 | Isuzu | 603-5602 | 23 | L56-0001 | Peterbilt | 315-5401 | 53 |
| 8-97855-152-0 | Isuzu | 602-5601 | 73 | L71-1002 | Kenworth | 938-5401 | 48 |
| 8-97855-154-0 | Isuzu | 602-5601 | 73 | L71-1004 | Kenworth | 938-5405 | 49 |
| 8-97867-721-1 | Isuzu | 760-5601 | 14 | L92-6000-0718 | Peterbilt | 924-5402 | 54 |
| 8-97867-722-1 | Isuzu | 760-5602 | 14 | N5346001 | Peterbilt | 603-5403 | 23 |
| 8C3Z2523200C | Ford | 748-181 | 66 | N5348001 | Peterbilt | 902-5402 | 26 |
| 8C3Z2523201C | Ford | 748-180 | 66 | N5355001 | Peterbilt | 603-5402 | 24 |
| 908-0223-01 | Kenworth | 904-5401 | 39 | Q21-1024-559 | Kenworth | 285-5405 | 34 |
| 908-0223-01 | Peterbilt | 904-5401 | 39 | Q21-1024-622 | Kenworth | 285-5404 | 34 |
| 93440852 | GMC | 625-188 | 29 | Q21-1043-622 | Kenworth | 285-5406 | 34 |
| 93440853 | GMC | 625-189 | 29 | Q21-6005 | Kenworth | 505-5406 | 59 |
| A05-16380-003 | Freightliner | 936-5201 | 5 | Q21-6005 | Peterbilt | 505-5406 | 59 |
| A05-16384-001 | Freightliner | 936-5202 | 5 | R21-1005 | Kenworth | 741-5403 | 69 |
| A06-307 69-027 | Freightliner | 901-5205 | 71 | R21-1005R | Kenworth | 741-5404 | 69 |
| A06-30769-008 | Freightliner | 901-5204 | 71 | R21-6011 | Peterbilt | 741-5401 | 70 |
| A06-30769-010 | Freightliner | 901-5206 | 45 | R21-6011R | Peterbilt | 741-5402 | 70 |
| A06-36956-002 | Freightliner | 978-5201 | 73 | R21-6013 | Peterbilt | 741-5405 | 70 |
| A06-75742-000 | Freightliner | 924-5201 | 44 | R21-6013R | Peterbilt | 741-5406 | 70 |
| A17-12081-000 | Freightliner | 924-5207 | 53 | R56-1025 | Kenworth | 760-5403 | 14 |
| A17-12082-000 | Freightliner | 924-5206 | 53 | R56-1025 | Peterbilt | 760-5403 | 15 |
| A17-13787-002 | Freightliner | 924-5202 | 54 | R56-1025R | Kenworth | 760-5408 | 14 |
| A17-13787-003 | Freightliner | 924-5203 | 54 | R56-1025R | Peterbilt | 760-5408 | 15 |
| A17-15553-000 | Freightliner | 315-5203 | 51 | R65-6019 | Peterbilt | 924-5401 | 17 |
| A17-15553-001 | Freightliner | 315-5202 | 50 | R86-6001 | Peterbilt | 603-5404 | 24 |
| A18-35381-000 | Freightliner | 760-5205 | 12 | RC0050 | Peterbilt | 902-5403 | 26 |
| A18-35381-001 | Freightliner | 760-5206 | 12 | SAA85920008 | Freightliner | 505-5201 | 57 |
| A18-42228-000 | Freightliner | 760-5203 | 11 | | | | |
| A18-42228-001 | Freightliner | 760-5204 | 11 | | | | |
| A18-42228-002 | Freightliner | 760-5202 | 11 | | | | |
| A18-42228-003 | Freightliner | 760-5201 | 11 | | | | |
| A18-47729-002 | Freightliner | 760-5208 | 12 | | | | |