

# INSTALL/REMOVAL INSTRUCTIONS: AIR SUSPENSION CONVERSION KIT

**ATTENTION:** Refer to the appropriate shop manual for your vehicle to obtain specific service procedures for this part. If you do not have a service manual or lack the skill to install this part, it is recommended that you seek the services of a qualified technician. Pay special attention to all cautions and warnings included in the shop manual. Read and follow all instructions carefully.

## **Air Suspension Conversion Kit**

### **General Installation Instructions**

When servicing any vehicle be sure to follow all safety procedures. First, make sure that when lifting the vehicle that you use an appropriate jack with a proper weight rating. Before going underneath any vehicle, make sure that it is properly supported with sturdy jack stands and on level ground so that the vehicle doesn't fall or slide off of the jack and onto you. As with any automotive repair, make sure you have the appropriate tools to do the job so you don't damage any parts on the vehicle. Safety glasses and mechanic's gloves should also be worn for your protection.

Take care not to exceed the Gross Vehicle Weight Rating (GVWR), or the maximum load recommended by the manufacturer. It is important that all the vehicle owner manuals recommendations are followed for your own safety and to prevent damage to the vehicle.

Once you are ready to disable the ride light, you will need to disconnect the negative battery cable (-) to prevent electrical shock/malfunction.

Dorman are proud to offer a high quality product at the industries most competitive pricing!

#### Disclaimer:

Even though every attempt is made to ensure this information is complete and accurate, it is impossible to account for all possible circumstances or situations. Please consult with a qualified auto technician before attempting to perform any work you are not qualified to do. Automobiles can be hazardous to work on; be sure to take all necessary safety precautions. Failure to do so may result in property damage or personal injury. Certain motor vehicle standards and performance requirements may apply to your motor vehicle (such as Federal Motor Vehicle Safety Standards by the National Highway Traffic Safety Administration). Be sure that your work is performed in accordance with such standards and that you do not disable any motor vehicle safety feature.

**ATTENTION:** Refer to the appropriate shop manual for your vehicle to obtain specific service procedures for this part. If you do not have a service manual or lack the skill to install this part, it is recommended that you seek the services of a qualified technician. Pay special attention to all cautions and warnings included in the shop manual. Read and follow all instructions carefully.

## Lincoln Continental 1995-2002 Quick Start Guide Rear Kit 1995-2002

### Parts Included in This Kit

- (2) #96 Coil Springs
- (4) Mounting Plates



- (2) # 96 Springs
- (4) Mounting Plates
- (2) Rear Shocks



### Tools Needed For Installation

- Metric socket set
- Floor jack
- Jack stands
- Metric wrenches
- Screw drivers (Phillips and flat head)
- Wire cutter/stripper/crimping tool
- Level work surface
- Spring compressor (if applicable)
- Allen wrenches

#### Disclaimer:

Even though every attempt is made to ensure this information is complete and accurate, it is impossible to account for all possible circumstances or situations. Please consult with a qualified auto technician before attempting to perform any work you are not qualified to do. Automobiles can be hazardous to work on; be sure to take all necessary safety precautions. Failure to do so may result in property damage or personal injury. Certain motor vehicle standards and performance requirements may apply to your motor vehicle (such as Federal Motor Vehicle Safety Standards by the National Highway Traffic Safety Administration). Be sure that your work is performed in accordance with such standards and that you do not disable any motor vehicle safety feature.

**ATTENTION:** Refer to the appropriate shop manual for your vehicle to obtain specific service procedures for this part. If you do not have a service manual or lack the skill to install this part, it is recommended that you seek the services of a qualified technician. Pay special attention to all cautions and warnings included in the shop manual. Read and follow all instructions carefully.

## Lincoln Continental 1995-2002 Air Bag Removal

**Read instructions carefully before attempting installation.**

- Turn "OFF" air suspension switch.  
Raise the vehicle and remove the tire and wheel assembly.



- Raise and support the vehicle.



- Remove the Air Line from the Solenoid.



### Disclaimer:

Even though every attempt is made to ensure this information is complete and accurate, it is impossible to account for all possible circumstances or situations. Please consult with a qualified auto technician before attempting to perform any work you are not qualified to do. Automobiles can be hazardous to work on; be sure to take all necessary safety precautions. Failure to do so may result in property damage or personal injury. Certain motor vehicle standards and performance requirements may apply to your motor vehicle (such as Federal Motor Vehicle Safety Standards by the National Highway Traffic Safety Administration). Be sure that your work is performed in accordance with such standards and that you do not disable any motor vehicle safety feature.

**ATTENTION:** Refer to the appropriate shop manual for your vehicle to obtain specific service procedures for this part. If you do not have a service manual or lack the skill to install this part, it is recommended that you seek the services of a qualified technician. Pay special attention to all cautions and warnings included in the shop manual. Read and follow all instructions carefully.

## Lincoln Continental 1995-2002 Air Bag Removal

- Remove the Air Spring solenoid. Rotate solenoid to the first stop. Pull back to release the air from the spring. Rotate to the second stop and remove the solenoid.



First stop

Solenoid removed

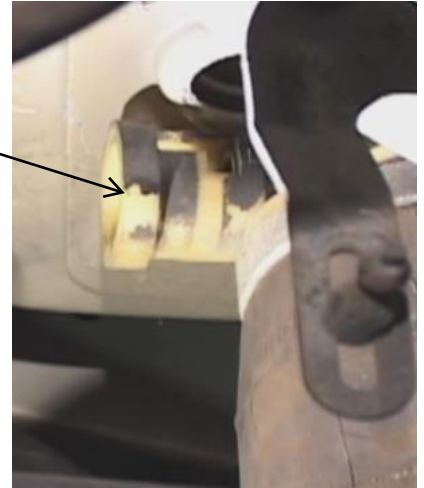

- Remove the 3 bolts from the lower Air Spring seat, and remove the Air Spring, by releasing the top locking tabs.



### Disclaimer:

Even though every attempt is made to ensure this information is complete and accurate, it is impossible to account for all possible circumstances or situations. Please consult with a qualified auto technician before attempting to perform any work you are not qualified to do. Automobiles can be hazardous to work on; be sure to take all necessary safety precautions. Failure to do so may result in property damage or personal injury. Certain motor vehicle standards and performance requirements may apply to your motor vehicle (such as Federal Motor Vehicle Safety Standards by the National Highway Traffic Safety Administration). Be sure that your work is performed in accordance with such standards and that you do not disable any motor vehicle safety feature.

**ATTENTION:** Refer to the appropriate shop manual for your vehicle to obtain specific service procedures for this part. If you do not have a service manual or lack the skill to install this part, it is recommended that you seek the services of a qualified technician. Pay special attention to all cautions and warnings included in the shop manual. Read and follow all instructions carefully.

## Lincoln Continental 1995-2002 Air Bag Removal

- Squeeze to release the top locking tab on the Air Spring.



- Press inwards to release the bottom locking tabs, then remove Air Spring from the bottom mount.



### Disclaimer:

Even though every attempt is made to ensure this information is complete and accurate, it is impossible to account for all possible circumstances or situations. Please consult with a qualified auto technician before attempting to perform any work you are not qualified to do. Automobiles can be hazardous to work on; be sure to take all necessary safety precautions. Failure to do so may result in property damage or personal injury. Certain motor vehicle standards and performance requirements may apply to your motor vehicle (such as Federal Motor Vehicle Safety Standards by the National Highway Traffic Safety Administration). Be sure that your work is performed in accordance with such standards and that you do not disable any motor vehicle safety feature.

**ATTENTION:** Refer to the appropriate shop manual for your vehicle to obtain specific service procedures for this part. If you do not have a service manual or lack the skill to install this part, it is recommended that you seek the services of a qualified technician. Pay special attention to all cautions and warnings included in the shop manual. Read and follow all instructions carefully.

## Lincoln Continental 1995-2002 Coil Spring Install

- The Coil Spring top and bottom bases are labeled to assist you in this install.



- Install the supplied bottom spring support by putting the bolt and washer through the bottom of the spring seat and install the plate and hardware on top of the spring seat. Tighten nut and bolt.

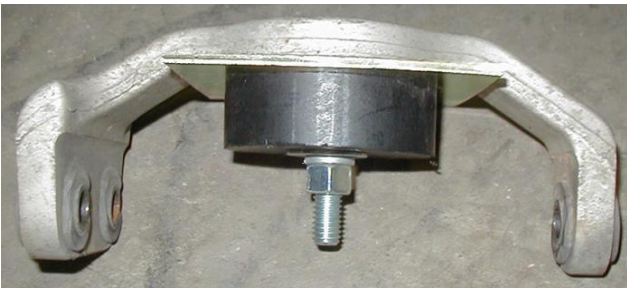

- Place the Coil Spring, hardware and lower spring seat on a jack and lift into place in the original Air Spring location. Clock the Coil Spring so that the writing is readable from the rear of the vehicle.



### Disclaimer:

Even though every attempt is made to ensure this information is complete and accurate, it is impossible to account for all possible circumstances or situations. Please consult with a qualified auto technician before attempting to perform any work you are not qualified to do. Automobiles can be hazardous to work on; be sure to take all necessary safety precautions. Failure to do so may result in property damage or personal injury. Certain motor vehicle standards and performance requirements may apply to your motor vehicle (such as Federal Motor Vehicle Safety Standards by the National Highway Traffic Safety Administration). Be sure that your work is performed in accordance with such standards and that you do not disable any motor vehicle safety feature.

**ATTENTION:** Refer to the appropriate shop manual for your vehicle to obtain specific service procedures for this part. If you do not have a service manual or lack the skill to install this part, it is recommended that you seek the services of a qualified technician. Pay special attention to all cautions and warnings included in the shop manual. Read and follow all instructions carefully.

## Lincoln Continental 1995-2002 Coil Spring Install

- Guide the top plate ears into upper mounting holes.



- Continue jacking until the spring is compressed enough to reinstall the three lower spring seat mounting bolts. (When reinstalling bolts reverse the bolts so that the nuts are on the inside of the spring seat)



**Note:** If only replacing the springs, continue onto the “Light Out” information.

#### Disclaimer:

Even though every attempt is made to ensure this information is complete and accurate, it is impossible to account for all possible circumstances or situations. Please consult with a qualified auto technician before attempting to perform any work you are not qualified to do. Automobiles can be hazardous to work on; be sure to take all necessary safety precautions. Failure to do so may result in property damage or personal injury. Certain motor vehicle standards and performance requirements may apply to your motor vehicle (such as Federal Motor Vehicle Safety Standards by the National Highway Traffic Safety Administration). Be sure that your work is performed in accordance with such standards and that you do not disable any motor vehicle safety feature.

**ATTENTION:** Refer to the appropriate shop manual for your vehicle to obtain specific service procedures for this part. If you do not have a service manual or lack the skill to install this part, it is recommended that you seek the services of a qualified technician. Pay special attention to all cautions and warnings included in the shop manual. Read and follow all instructions carefully.

## Lincoln Continental 1995-2002 Rear Shock Removal

- Remove the side trim panel in the trunk, and remove the mass damper retaining clip. See Illustration

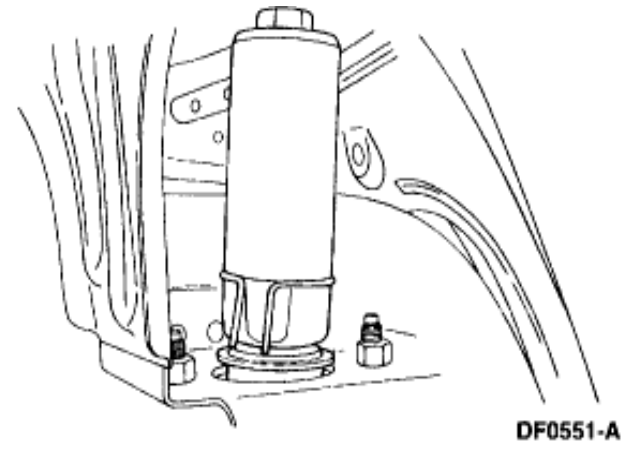

- If so equipped, disconnect the shock absorber electrical connector and wiring routing retaining clips
- Remove the two upper shock absorber mounting bolts



#### Disclaimer:

Even though every attempt is made to ensure this information is complete and accurate, it is impossible to account for all possible circumstances or situations. Please consult with a qualified auto technician before attempting to perform any work you are not qualified to do. Automobiles can be hazardous to work on; be sure to take all necessary safety precautions. Failure to do so may result in property damage or personal injury. Certain motor vehicle standards and performance requirements may apply to your motor vehicle (such as Federal Motor Vehicle Safety Standards by the National Highway Traffic Safety Administration). Be sure that your work is performed in accordance with such standards and that you do not disable any motor vehicle safety feature.



**ATTENTION:** Refer to the appropriate shop manual for your vehicle to obtain specific service procedures for this part. If you do not have a service manual or lack the skill to install this part, it is recommended that you seek the services of a qualified technician. Pay special attention to all cautions and warnings included in the shop manual. Read and follow all instructions carefully.

## Lincoln Continental 1995-2002 Rear Shock Removal

- Remove the bottom mounting bolt.
- Remove the electrical connector (if equipped).
- Remove the shock.



- Remove the top mounting hardware from the old shock.



### Disclaimer:

Even though every attempt is made to ensure this information is complete and accurate, it is impossible to account for all possible circumstances or situations. Please consult with a qualified auto technician before attempting to perform any work you are not qualified to do. Automobiles can be hazardous to work on; be sure to take all necessary safety precautions. Failure to do so may result in property damage or personal injury. Certain motor vehicle standards and performance requirements may apply to your motor vehicle (such as Federal Motor Vehicle Safety Standards by the National Highway Traffic Safety Administration). Be sure that your work is performed in accordance with such standards and that you do not disable any motor vehicle safety feature.

**ATTENTION:** Refer to the appropriate shop manual for your vehicle to obtain specific service procedures for this part. If you do not have a service manual or lack the skill to install this part, it is recommended that you seek the services of a qualified technician. Pay special attention to all cautions and warnings included in the shop manual. Read and follow all instructions carefully.

## Lincoln Continental 1995-2002 Rear Shock Installation

- Install the factory mounting bracket to the new replacement shock using the provided hardware as shown in the illustration. Tighten nut.

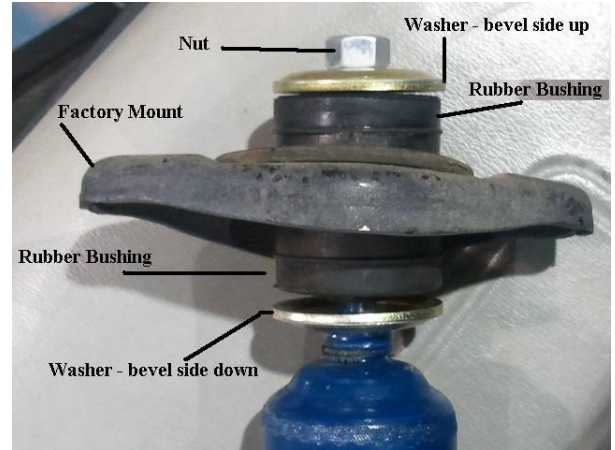

- Install the rear shock bottom mount first.



- Then install the top mount. Tighten to factory specifications.
- Reinstall the wheels and lower vehicle to the ground.



### Disclaimer:

Even though every attempt is made to ensure this information is complete and accurate, it is impossible to account for all possible circumstances or situations. Please consult with a qualified auto technician before attempting to perform any work you are not qualified to do. Automobiles can be hazardous to work on; be sure to take all necessary safety precautions. Failure to do so may result in property damage or personal injury. Certain motor vehicle standards and performance requirements may apply to your motor vehicle (such as Federal Motor Vehicle Safety Standards by the National Highway Traffic Safety Administration). Be sure that your work is performed in accordance with such standards and that you do not disable any motor vehicle safety feature.

**ATTENTION:** Refer to the appropriate shop manual for your vehicle to obtain specific service procedures for this part. If you do not have a service manual or lack the skill to install this part, it is recommended that you seek the services of a qualified technician. Pay special attention to all cautions and warnings included in the shop manual. Read and follow all instructions carefully.

## Lincoln Continental 1995-2002

**Note: Do not proceed to wiring repair if only installing 2 wheels**

- The new springs may soften and settle some during the first few weeks of use.
- (2 wheel kit only) - Securely plug the two rear air lines with a tight fitting screw and epoxy.
- (2 wheel kit only) - Plug the air spring solenoids back into their electrical connector and tie up securely underneath of the car.
- Turn the air ride switch in the trunk back "ON", and leave on to control the electronic struts.
- Set the ride control button on the dash to "Plush"
- (4 wheel kit only) - Disconnect compressor.

**Note: The rear springs may settle some during the first couple of weeks of use. It may be necessary to adjust the front torsion bars to match the level of your new rear springs.**

- The rear springs can sit a little low if the rear shocks are bad. Test the rear shocks by pushing down on the rear of the car. If the rear bounces then also replace the shocks.
- With electronic struts/shocks, it is necessary to remove the actuators from the struts/shocks and plug them into the vehicles harness. Secure the actuators to the body using a zip tie.

Disclaimer:

Even though every attempt is made to ensure this information is complete and accurate, it is impossible to account for all possible circumstances or situations. Please consult with a qualified auto technician before attempting to perform any work you are not qualified to do. Automobiles can be hazardous to work on; be sure to take all necessary safety precautions. Failure to do so may result in property damage or personal injury. Certain motor vehicle standards and performance requirements may apply to your motor vehicle (such as Federal Motor Vehicle Safety Standards by the National Highway Traffic Safety Administration). Be sure that your work is performed in accordance with such standards and that you do not disable any motor vehicle safety feature.

**ATTENTION:** Refer to the appropriate shop manual for your vehicle to obtain specific service procedures for this part. If you do not have a service manual or lack the skill to install this part, it is recommended that you seek the services of a qualified technician. Pay special attention to all cautions and warnings included in the shop manual. Read and follow all instructions carefully.

## Lincoln Continental 1995-2002 Light Out Instructions

**Read the instructions carefully before attempting the installation.**

- In order to disarm the air ride suspension warning message it's necessary to bypass the VDM (Vehicle Dynamic Module) that controls the air ride functions.
- The VDM is located under the rear window on the driver's side in the trunk.

The wires for the module can be accessed under the rear seat.

The procedure is as follows:

- To access the wiring remove the rear seat cushion.
- First locate the brackets the seat cushion lock onto.
- Using both hands first press down firmly then press back-towards trunk. This will release the seat lock. This needs to be done on both sides of the seat.
- Lift out the seat cushion.



**Disclaimer:**

Even though every attempt is made to ensure this information is complete and accurate, it is impossible to account for all possible circumstances or situations. Please consult with a qualified auto technician before attempting to perform any work you are not qualified to do. Automobiles can be hazardous to work on; be sure to take all necessary safety precautions. Failure to do so may result in property damage or personal injury. Certain motor vehicle standards and performance requirements may apply to your motor vehicle (such as Federal Motor Vehicle Safety Standards by the National Highway Traffic Safety Administration). Be sure that your work is performed in accordance with such standards and that you do not disable any motor vehicle safety feature.

**ATTENTION:** Refer to the appropriate shop manual for your vehicle to obtain specific service procedures for this part. If you do not have a service manual or lack the skill to install this part, it is recommended that you seek the services of a qualified technician. Pay special attention to all cautions and warnings included in the shop manual. Read and follow all instructions carefully.

## Lincoln Continental 1995-2002 Light Out Instructions

- Remove the sound insulation from under the seat.



- The wiring harness will be located on the driver's side, under the insulation.

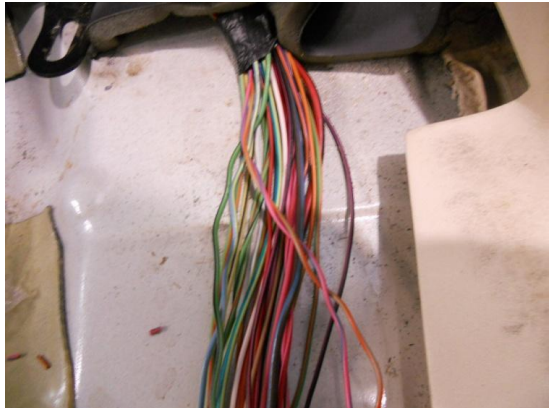

- Separate the wires from the protective covering and locate the following 2 wires that will be twisted together:
  - 1-pink wire with a light blue stripe
  - 2-tan wire with an orange stripe.



Disclaimer:

Even though every attempt is made to ensure this information is complete and accurate, it is impossible to account for all possible circumstances or situations. Please consult with a qualified auto technician before attempting to perform any work you are not qualified to do. Automobiles can be hazardous to work on; be sure to take all necessary safety precautions. Failure to do so may result in property damage or personal injury. Certain motor vehicle standards and performance requirements may apply to your motor vehicle (such as Federal Motor Vehicle Safety Standards by the National Highway Traffic Safety Administration). Be sure that your work is performed in accordance with such standards and that you do not disable any motor vehicle safety feature.

**ATTENTION:** Refer to the appropriate shop manual for your vehicle to obtain specific service procedures for this part. If you do not have a service manual or lack the skill to install this part, it is recommended that you seek the services of a qualified technician. Pay special attention to all cautions and warnings included in the shop manual. Read and follow all instructions carefully.

## Lincoln Continental 1995-2002 Light Out Instructions

- Cut both of these wires and tape both ends.



- Next supply power to the power steering solenoid.
- This is achieved by locating the light green wire with the black stripe.  
**Caution: Do not use if it is twisted with the light green with red striped wire.**  
There is another light green wire with black stripe that is larger gauge; this is the one needed

- The light green wire with black stripe needs to be cut.
- Tape off the end that goes to the trunk
- The end that goes to the front of the vehicle goes to a body ground.



### Disclaimer:

Even though every attempt is made to ensure this information is complete and accurate, it is impossible to account for all possible circumstances or situations. Please consult with a qualified auto technician before attempting to perform any work you are not qualified to do. Automobiles can be hazardous to work on; be sure to take all necessary safety precautions. Failure to do so may result in property damage or personal injury. Certain motor vehicle standards and performance requirements may apply to your motor vehicle (such as Federal Motor Vehicle Safety Standards by the National Highway Traffic Safety Administration). Be sure that your work is performed in accordance with such standards and that you do not disable any motor vehicle safety feature.

**ATTENTION:** Refer to the appropriate shop manual for your vehicle to obtain specific service procedures for this part. If you do not have a service manual or lack the skill to install this part, it is recommended that you seek the services of a qualified technician. Pay special attention to all cautions and warnings included in the shop manual. Read and follow all instructions carefully.

## Lincoln Continental 1995-2002 Light Out Instructions

- Find a painted stud under the seat/door trim. Properly clean all paint from this area prior to making ground connection.



- Suggested body ground light green wire with black stripe taken to ground point.

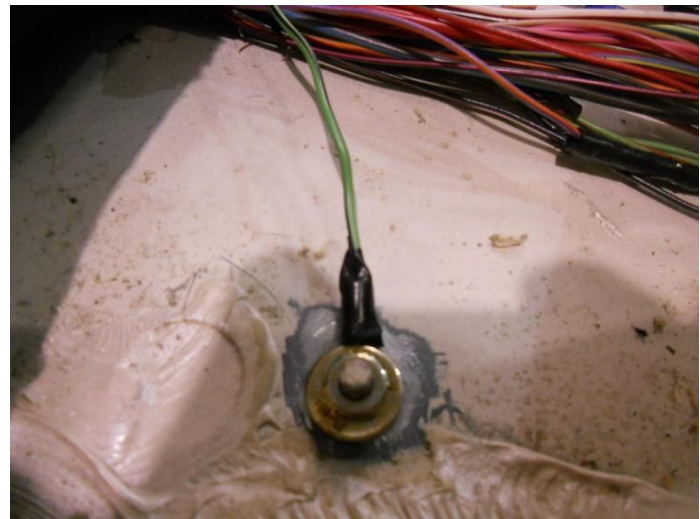

- Supply power to the steering solenoid.  
Cut the light blue with yellow striped wire, and splice it into the 10 amp VDM power wire Ignition power source.
  - For 1995-1997 this is a purple wire with orange stripe. (p/o)
  - For 1998 and up this is a light green with purple stripe. (lg/p)

#### Disclaimer:

Even though every attempt is made to ensure this information is complete and accurate, it is impossible to account for all possible circumstances or situations. Please consult with a qualified auto technician before attempting to perform any work you are not qualified to do. Automobiles can be hazardous to work on; be sure to take all necessary safety precautions. Failure to do so may result in property damage or personal injury. Certain motor vehicle standards and performance requirements may apply to your motor vehicle (such as Federal Motor Vehicle Safety Standards by the National Highway Traffic Safety Administration). Be sure that your work is performed in accordance with such standards and that you do not disable any motor vehicle safety feature.

**ATTENTION:** Refer to the appropriate shop manual for your vehicle to obtain specific service procedures for this part. If you do not have a service manual or lack the skill to install this part, it is recommended that you seek the services of a qualified technician. Pay special attention to all cautions and warnings included in the shop manual. Read and follow all instructions carefully.

## Lincoln Continental 1995-2002 Light Out Instructions

- Cut the light blue with yellow stripe wire and tape off the end that goes to the trunk. Splice the end that goes to the front of the car into the 10 amp VDM wire.
- When finished replace seat in reverse order.

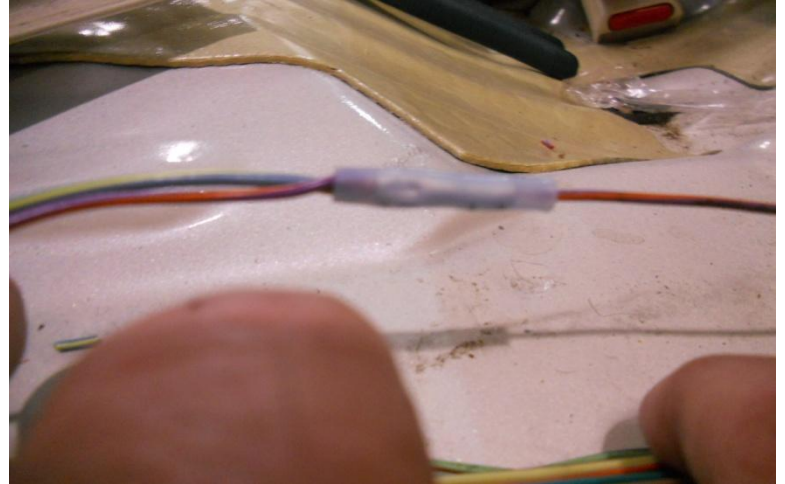

- When complete, if power steering does not function, the most common cause is the ground connection.
- The second most common cause is the fuse for the 10 amp VDM wire. Fuse # 28 in the IP fuse panel.
- The fuse panel is located under the steering column.

