

SSC1 Pro White Standard LED Pod



FEATURES

STAGE
SERIES



- Compact single-LED form factor
- High intensity LED chip
- Backlighting available in amber and red
- Durable powdercoated aluminum construction
- Integrated Deutsch-style connector
- Designed, torture tested and assembled in USA

GENERAL SPECIFICATIONS

Optic	Peak Beam Intensity (Candela)	Illuminance (lux @10m)	Measured Output (Lumens)	Raw Output (Lumens)	Output Color
Wide	5,400 cd	54 lux	2,300 lm	2,375 lm	6000K White
Flood	925 cd	9 lux	2,300 lm	2,375 lm	6000K White
Spot	23,000 cd	230 lux	2,300 lm	2,375 lm	6000K White

Functions: White Output with Amber and Red Backlight

Voltage Range: 9-16V

Current Draw (amps @ 12.8V): 1.7A (output), 24mA (backlight)

Wattage: 21.9W (output), 0.3W (backlight)

Connector Type: 4 Pin DT Connector

Driver Type: Integrated Driver

LED Type/Count: Cree XHP50 6000K/1 total, 3014/3 total

Compliance Rating: J575 Durability Test

Intrusion Rating: IP67 Weatherproof

Operating Temperature: -40°C to 85°C

What's Included:

- One (1) or Two (2) SSC1 Standard LED Pods
- One (1) or Two (2) Deutsch-style wire pigtails
- One (1) or Two (2) Mounting brackets and hardware

Dimensions & Weight:

Length: 7.5" **Width:** 4.5" **Height:** 3"

Weight: 0.7 lbs (single), 1.2 lbs (pair)

SKUs: Append "S" to the end of each SKU for single and "P" for pair

DD6455 SSC1 Pro White Wide Standard ABL
DD6456 SSC1 Pro White Wide Standard RBL

DD6460 SSC1 Pro White Flood Standard ABL
DD6461 SSC1 Pro White Flood Standard RBL

DD6465 SSC1 Pro White Spot Standard ABL
DD6466 SSC1 Pro White Spot Standard RBL

All data and specifications are nominal values and may vary.

PUBLISHED: 10-24-2024

COLORIMETRIC SPECIFICATIONS

WHITE MAIN BEAM

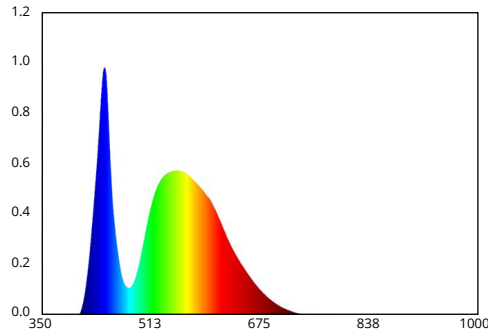

Spectral Distribution

CHROMATICITY

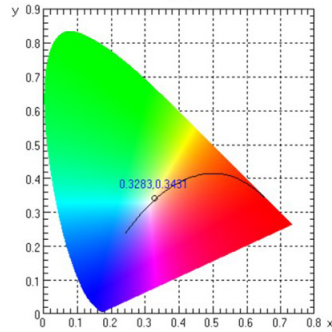

X=0.3283, Y=0.3431

AMBER BACKLIGHT

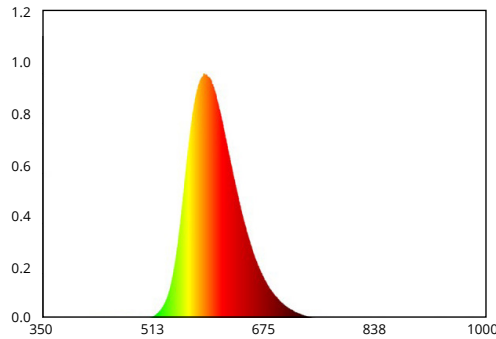

Spectral Distribution

CHROMATICITY

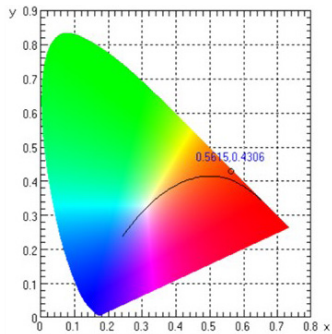

X=0.5615, Y=0.4306

RED BACKLIGHT

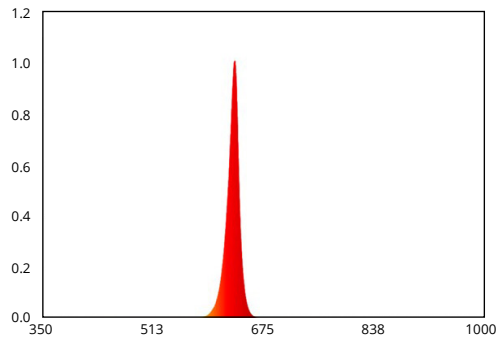

Spectral Distribution

CHROMATICITY

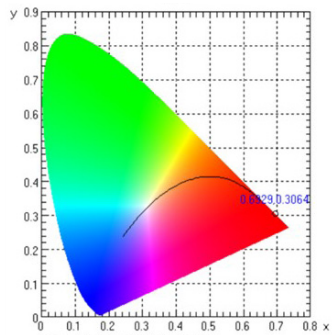

X=0.6929, Y=0.3064

PUBLISHED: 10-24-2024

PRODUCT DIMENSIONS

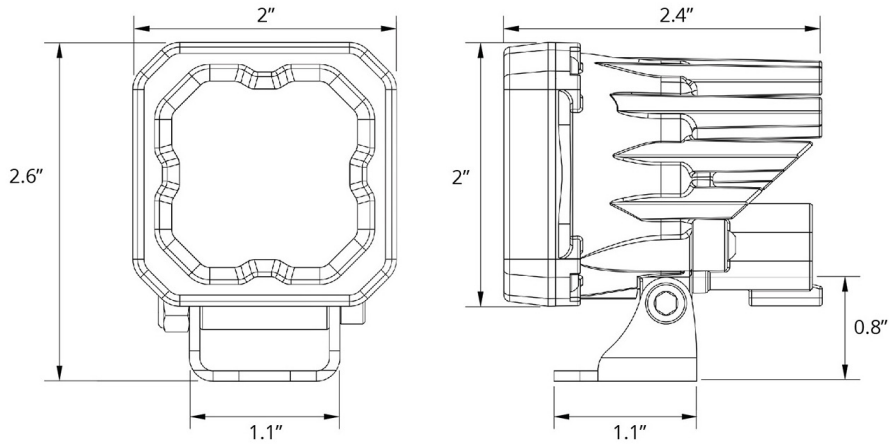

PHOTOMETRIC SPECIFICATIONS

Wide Optic Isolux

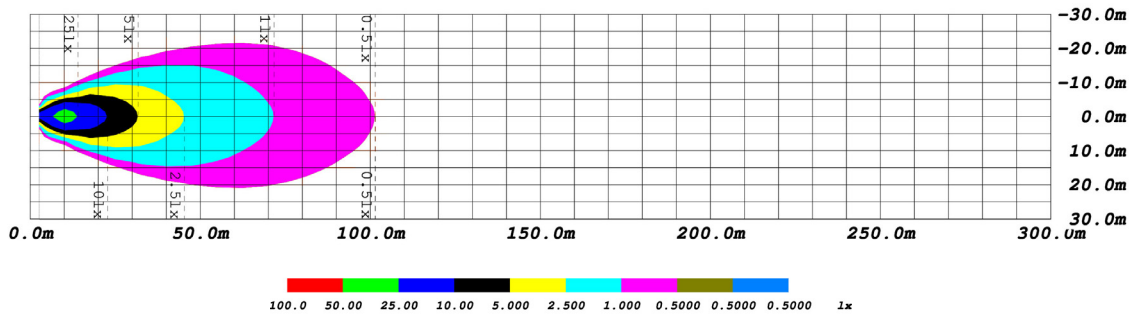

Wide Optic Perspective

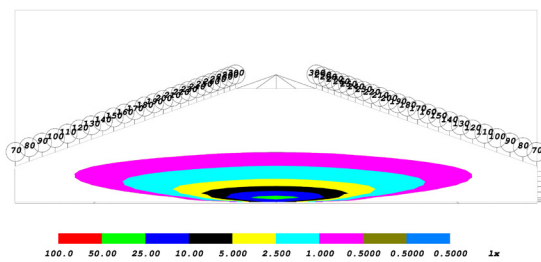

Wide Optic Isocandela

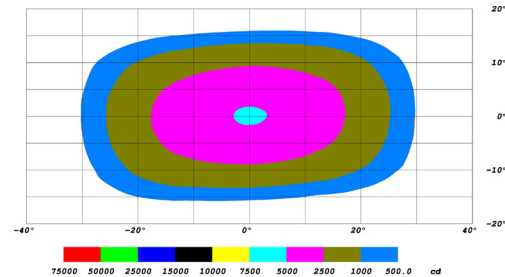

PUBLISHED: 10-24-2024

PHOTOMETRIC SPECIFICATIONS (cont.)

Flood Optic Isolux

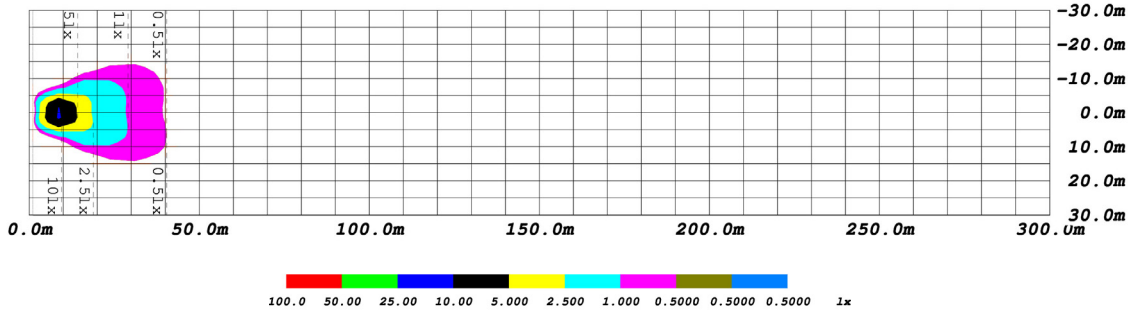

Flood Optic Perspective

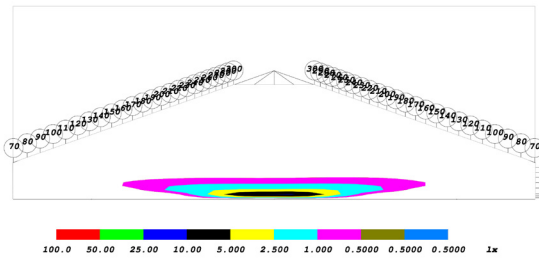

Flood Optic Isocandela

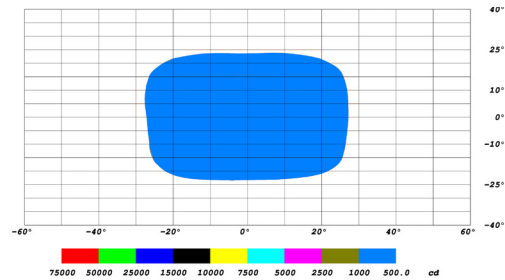

Spot Optic Isolux

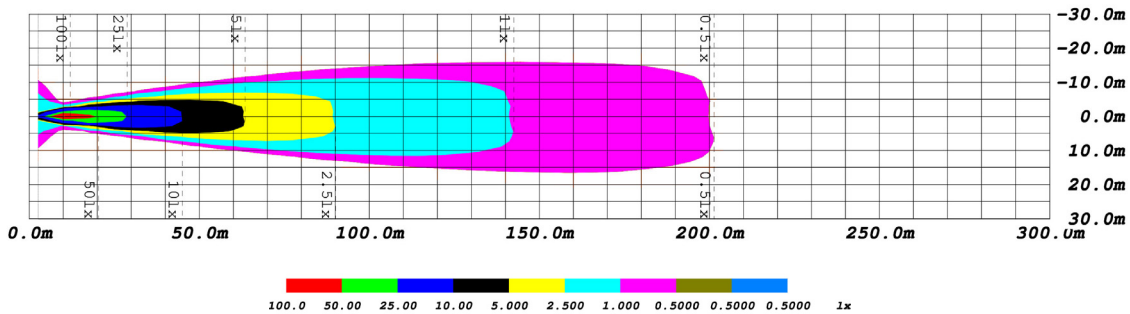

Spot Optic Perspective

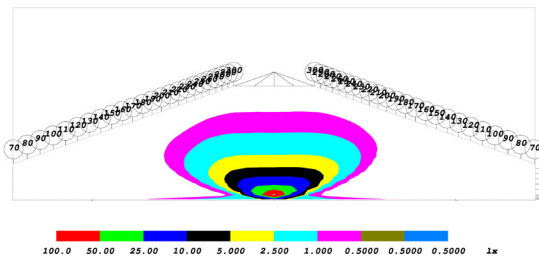

Spot Optic Isocandela

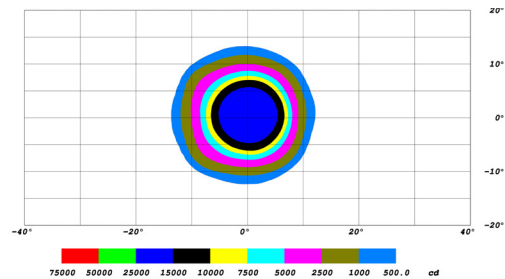

PUBLISHED: 10-24-2024