



Thank you for being selective enough to choose a Dinan Performance Exhaust System. The Dinan Engineering Team has spent many hours developing this product to assure that you will receive increased performance, durability and an aesthetic design that you as a customer will be able to enjoy for many years. Ease of installation and maintenance is important to us and has been highly considered throughout the design process.

Prior to performing the installation, familiarize yourself with these instructions as it should help you with the process. If you feel that you do not have the required skills or tools, please arrange for a qualified repair facility to perform the installation.

Again, thank you for choosing Dinan. Enjoy.

## Installation Instructions

**D660-0083(-BLK)**

**Vehicle List:  
2016-2020 F60 MINI COUNTRYMAN S  
FWD EXHAUST**

Document Revision: A

### Table of Contents

Parts List.....	2
Removal of Stock Exhaust System.....	3
Installation of Dinan System .....	4
Installation of Wiring for Exhaust Valve.....	11

**Parts List:**

Quantity	Part #	Description
1	D663-0349	Muffler Assembly; F60
1	D662-0602	Inlet Tube; F60 FWD
1	D663-0600	Exhaust Tip
1	D663-0352	Hardware Kit

**Contains:**

1	D661-0031	Exhaust Valve Spring
1	D662-0433	Exhaust Valve Mount
3	D671-0189	M6 Locknut
3	D671-0377	M6 Socket Head Bolts
9	M6 Flat	Washer
3	M6 Wave	Washer
3	D662-9228	Single Bolt Clamp, 2.75"
1	D662-9241	Double Bolt Clamp, 2.75"
1	D663-0353	Exhaust Valve Controller Kit

### Removal of Stock Exhaust System:

- 1) Cut 2-3/4" from the brace, towards the back of the car.
- 2) Support the exhaust and remove the hangers from the car.
- 3) Remove the stock system from the car.

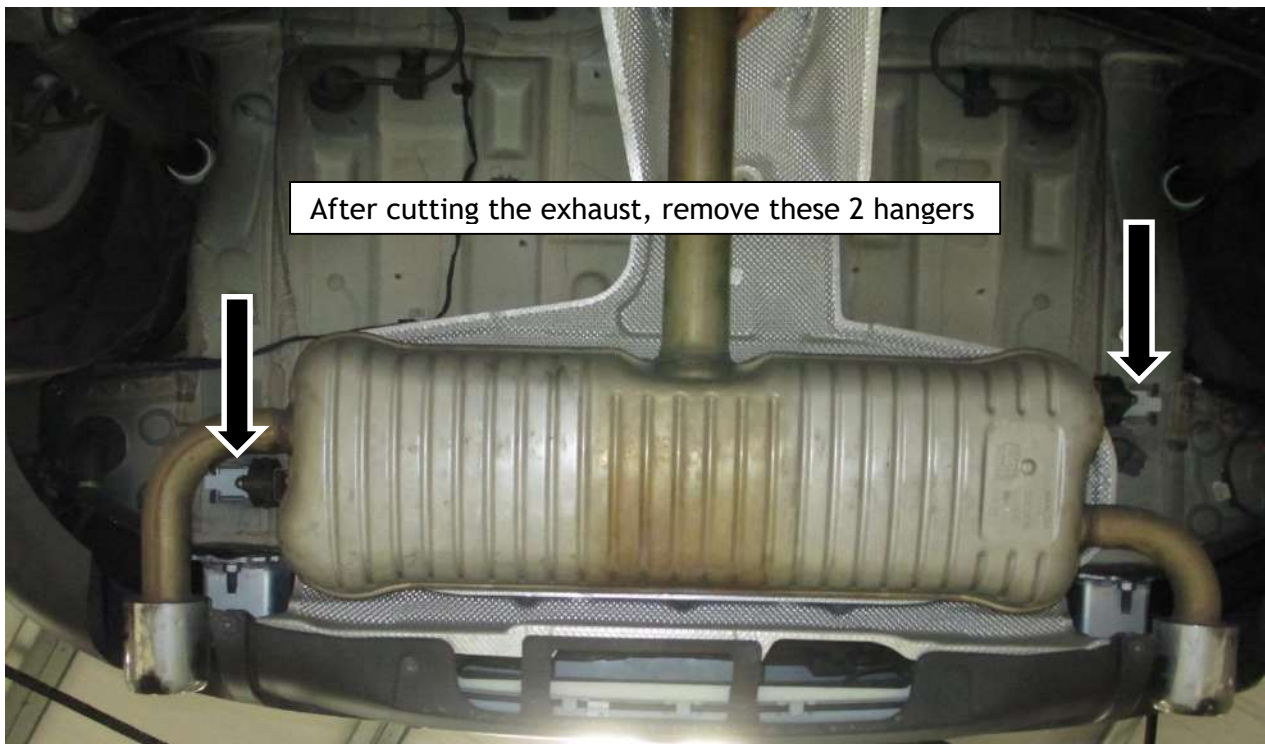
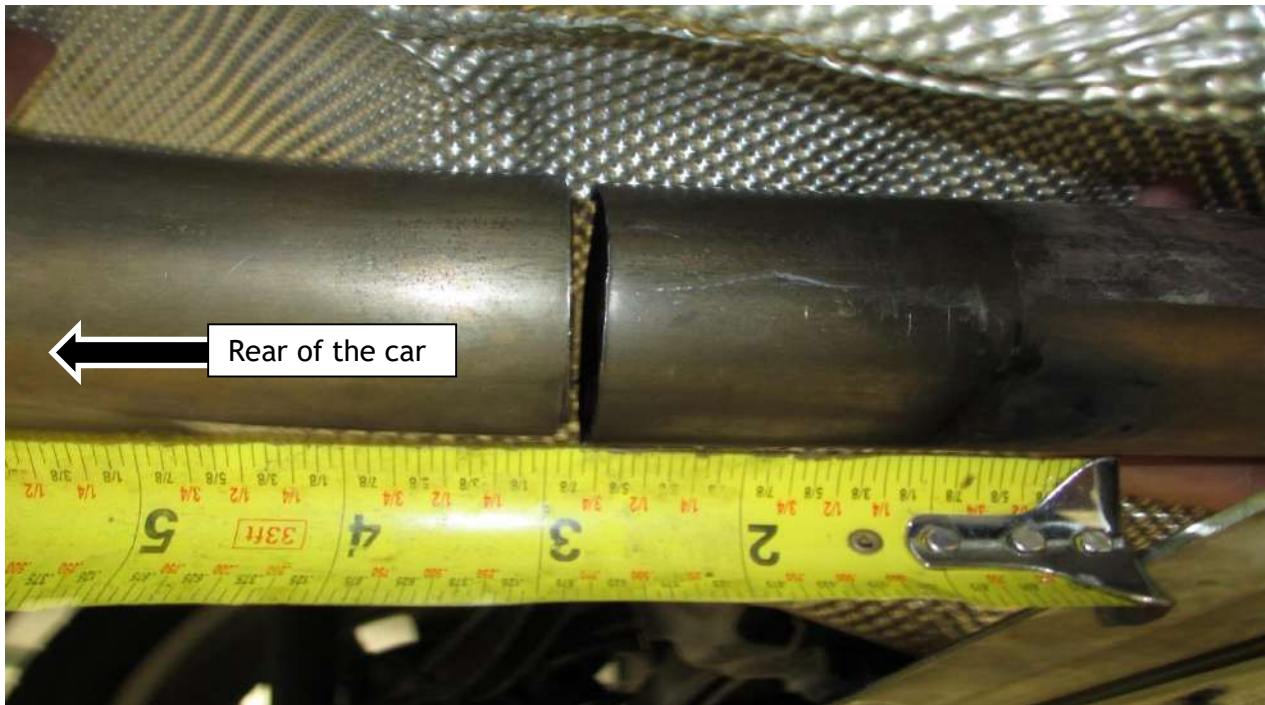

### Installation of Dinan System:

- 1) Slide the 63.5mm clamp onto the inlet tube on the ends with the slots.
- 2) Slide the inlet tube onto the exhaust at the cut point.
- 3) Make sure the clamp is facing the driver's side with the bolts facing down.
- 4) Slide the coupler clamp onto the inlet tube.



Exhaust Valve Assembly:

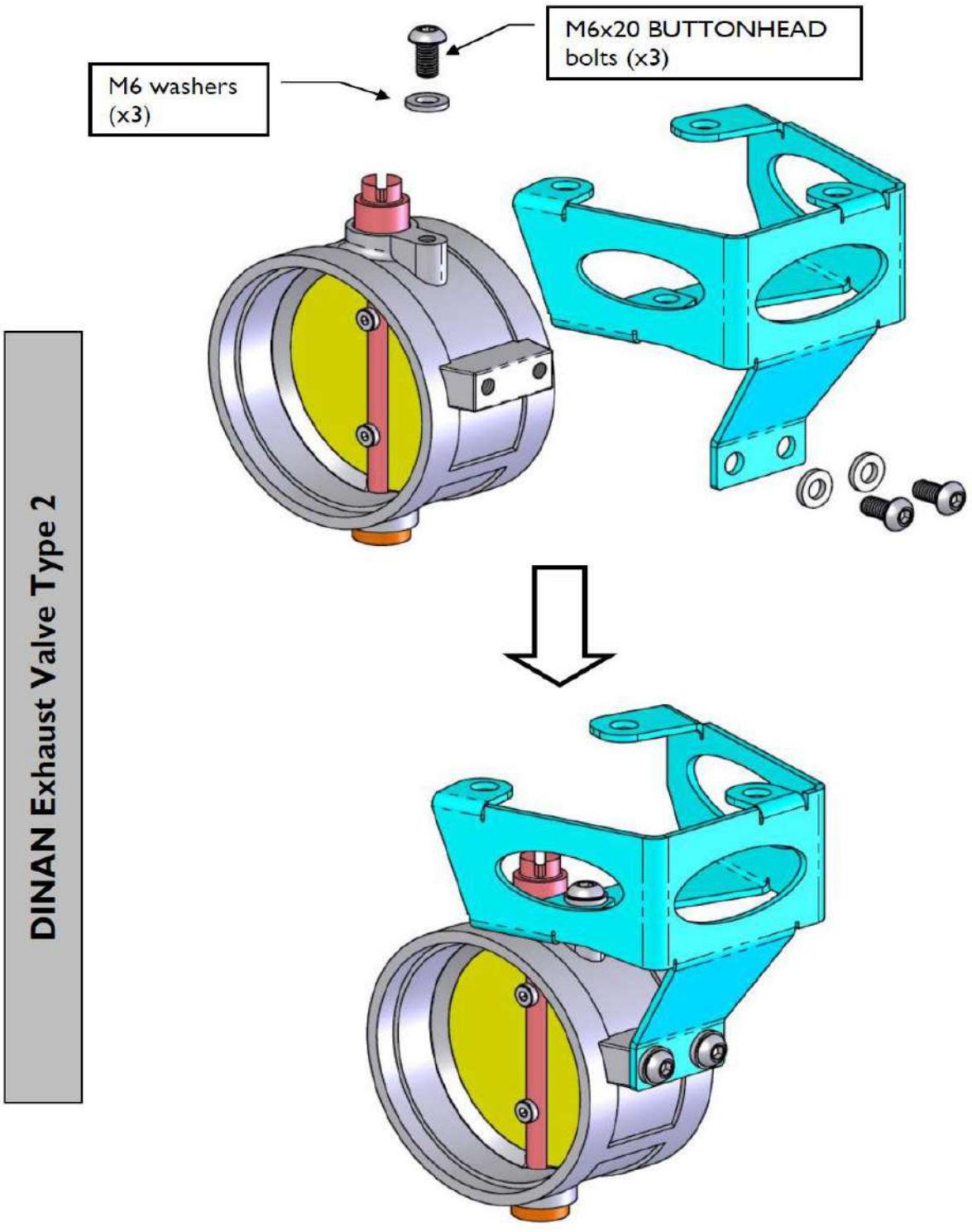

**DINAN Exhaust Valve Type 2**

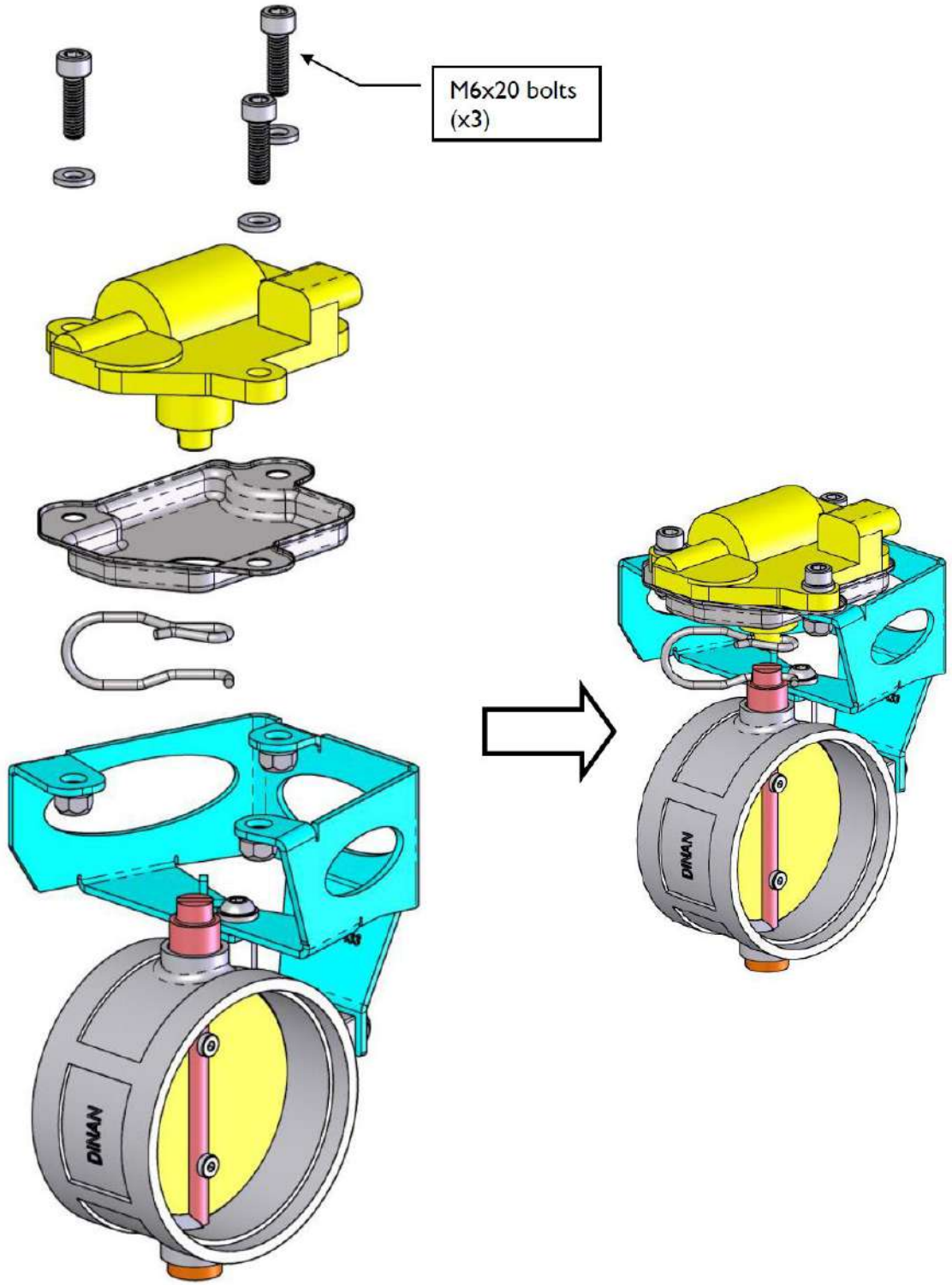

### Installation of Dinan Muffler:

- 1) Remove the rubber hangers from the stock exhaust.
- 2) Slide the hangers onto the Dinan Muffler.
- 3) Lift muffler assembly up in to place.
- 4) Install the 2 nuts for the hanger mounts.

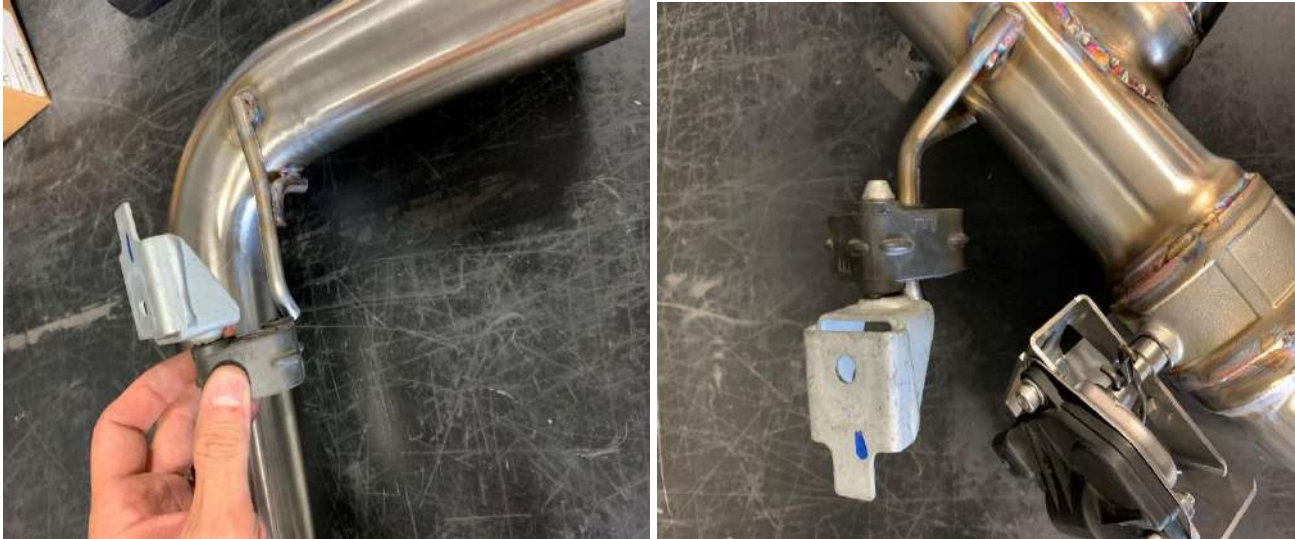

5) Slide the coupler clamp on, push up on the exhaust and toward the front of the car, and lightly tighten the coupler clamp.

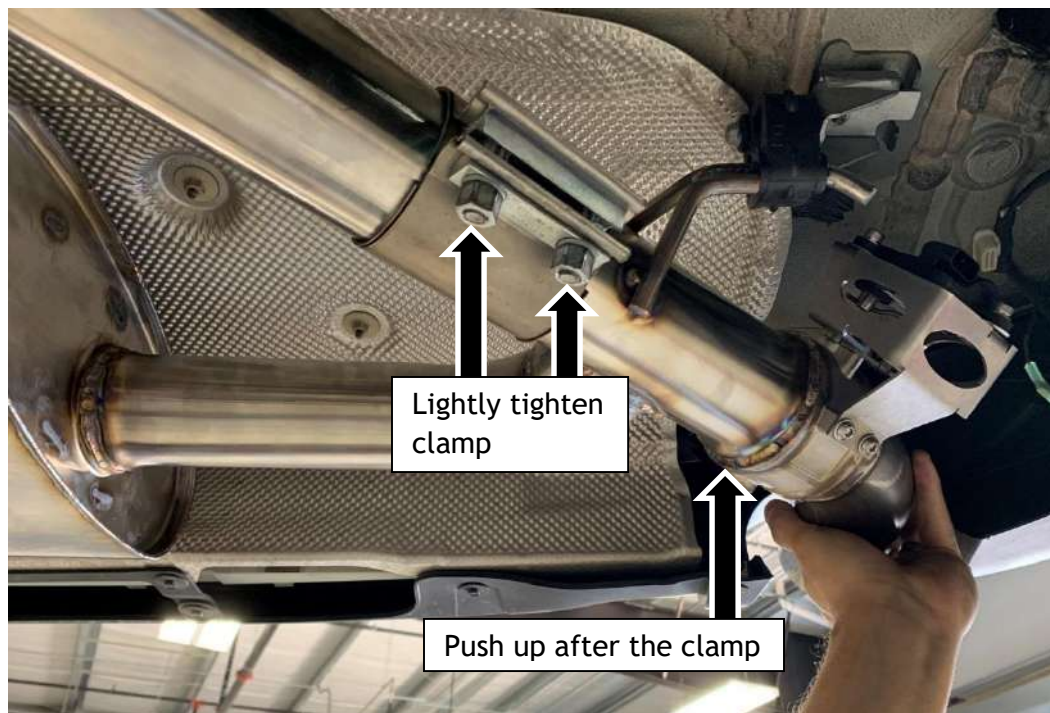



### Installation of Exhaust Tips:

- 1) Install the 69.9mm clamp on tips with bolts clocked towards logo.
  - The bolts should face towards the outside of the car.
  - The tip pictured is the passenger's side tip. The driver's side tip should have the bolt end facing the opposite direction.
  
- 2) The tips should be clocked where the middle of the first N is centered.
  - Line up the tips where the bumper is aligned to the tip edge.
  - Once the tips are aligned, tighten the tip clamps without damaging the pipe.

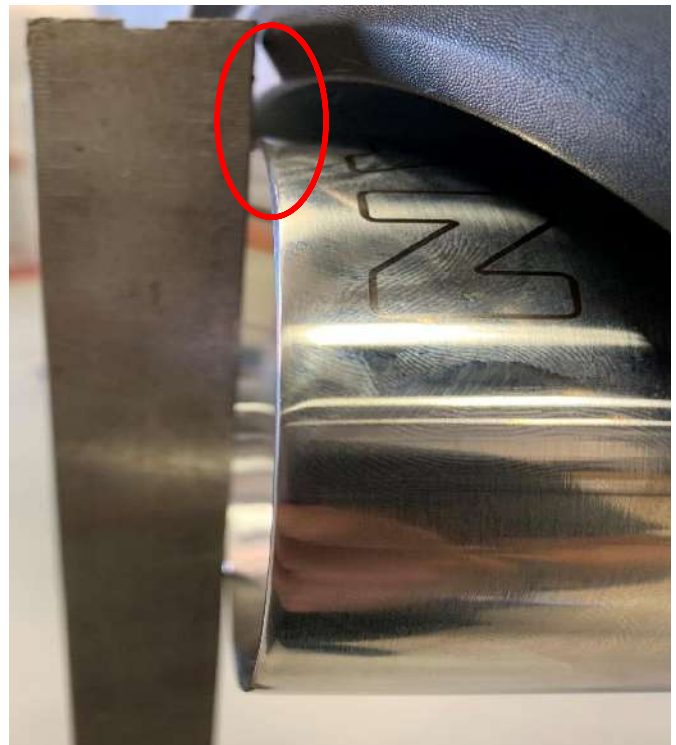

- 2) To adjust the fitment, twist the inlet tube to adjust the tip fitment.
- 3) Push the tips towards the front of the car and tighten the coupler clamps.

Torque all clamps to specifications listed below:

- Exhaust Tip Clamps: 45 ft-lbs
- Torca Coupler (2-Bolt) Clamp: 45 ft-lbs
- 1-Bolt Adapter Clamp: 45 ft-lbs

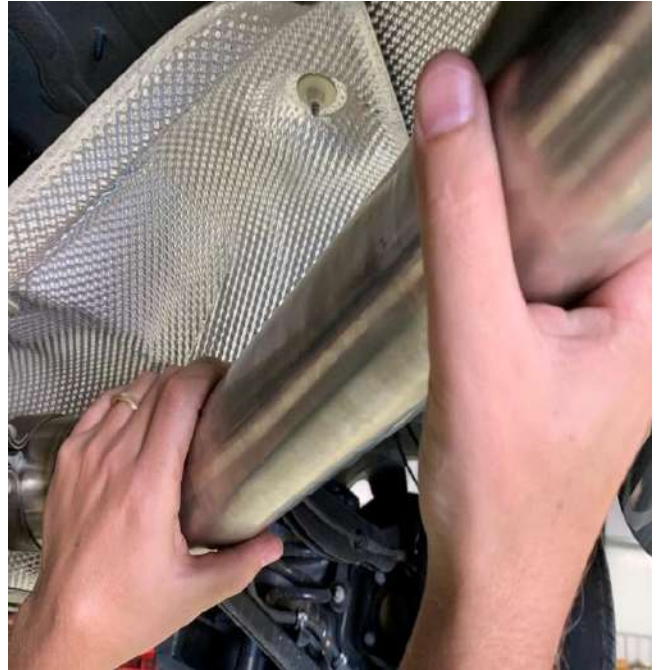

## Installation of Wiring for Exhaust Valve

- 1) On the driver's side wheel well, remove this screw and move the wheel well shield out of the way.
  - a. Pulling back the shield and locate the grommet.
  - b. Remove this grommet.
  - c. Feed the connector plugs into the grommet hole and install the grommet into the hole.



- 2) Open the rear hatch and look to the left.
  - a. Remove this small panel from the trunk wall.
  - b. Raise the floor panel.

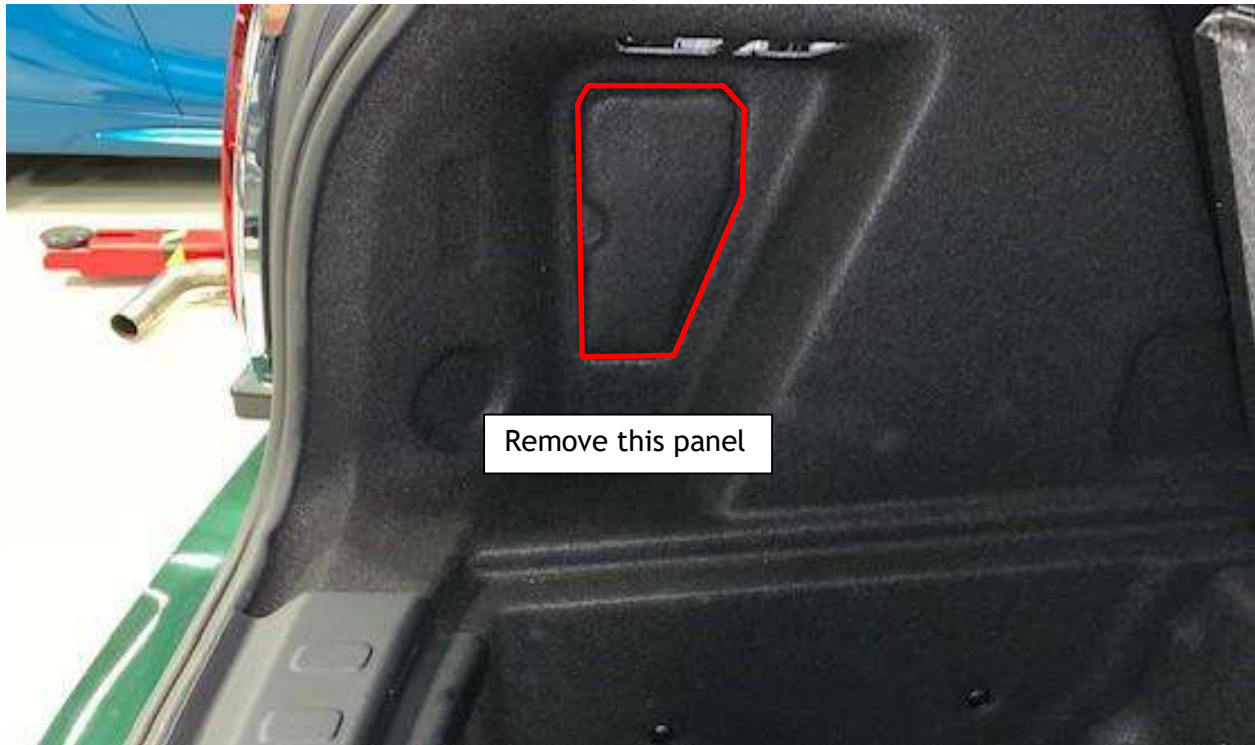

3) Remove all the marked pins in the pictures below from the trunk trim, carefully remove the trim.



- 4) Carefully move the driver's side paneling back.
  - a. Locate the wires you fed through in step 2 in the pocket below the panel.
  - b. Pull the wires up.

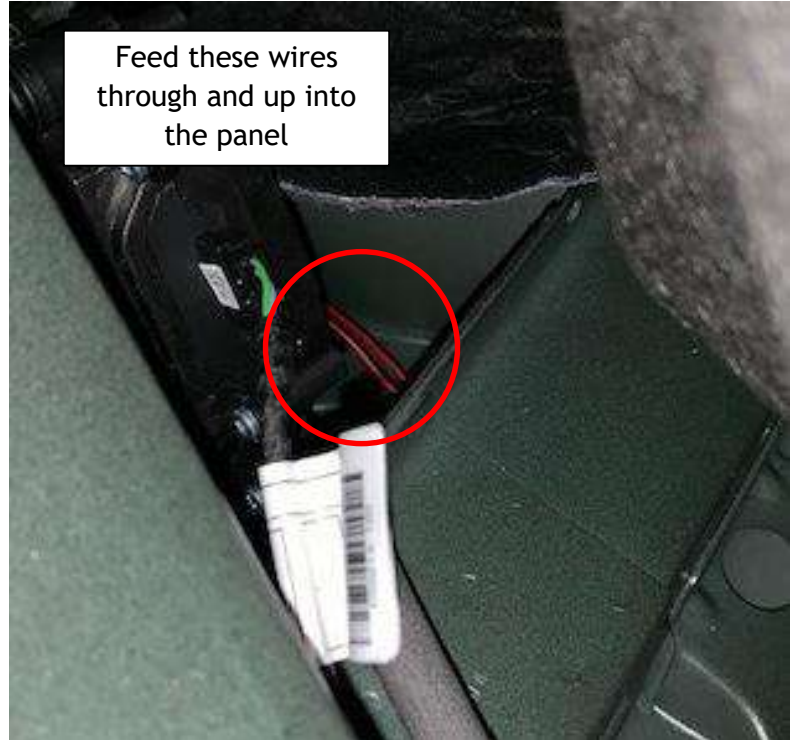

- 5) Locate the control box in your provided kit and attach the red and white wires you've just pulled through.
  - a. Attach the control box to the driver's side trunk wall with the supplied Velcro or Zip Tie.

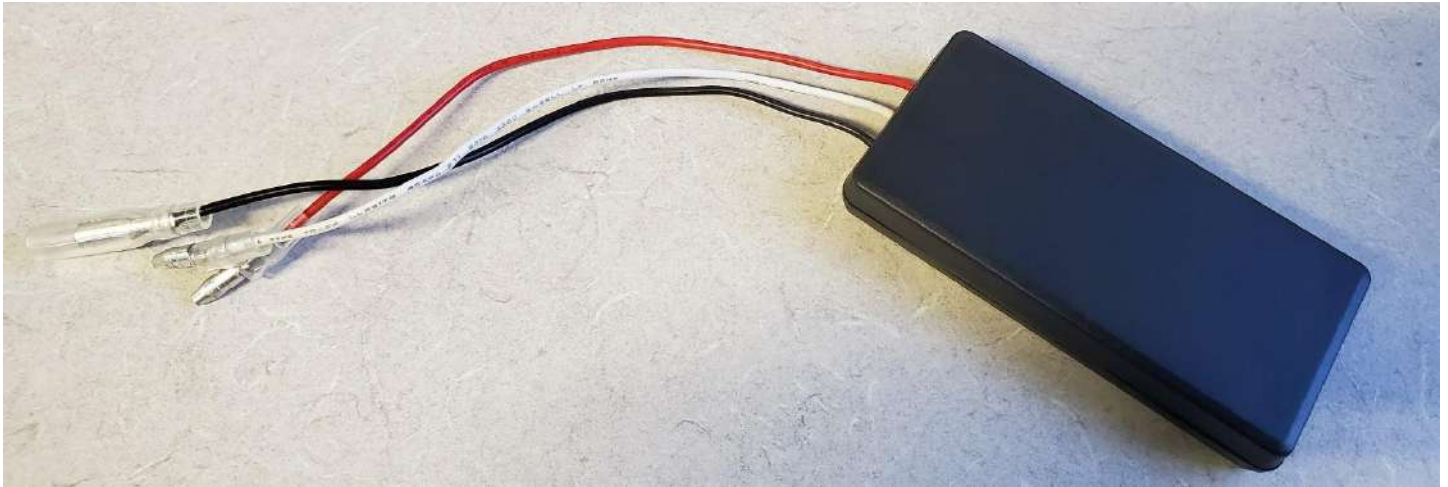

- 6) On the second set of wires, there is a black wire and a red wire with a small fuse attached.
  - a. Plug the red wire into the second red plug on the control box.
  - b. Run the wire from the control box to the passenger's side panel, running the wires behind any paneling using zip ties to secure the wires.





- 7) On the passenger's side locate and remove the dome light from its housing. Run the red wire into the dome light hole.

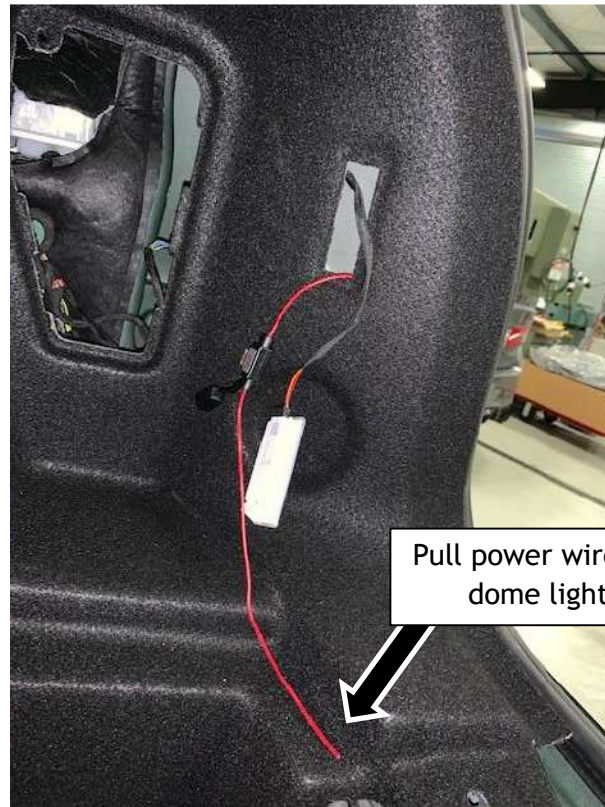

- 8) Grab the red power wire you pulled through and the dome light power cable.
- Use the provided Scotchlok adaptor to splice the cables together.
  - Place unstripped red wire inside appropriate channels.
  - The ends of the wires should always be placed midway between connector element and end of connector for proper installation.
  - To the wires and make the connection by driving the u-contact down flush with the top of the plastic insulator body.
  - Close hinged top cover until latched.



- f. After splicing, reinstall the dome light.

- 9) On the driver's side, behind the removed panel from step 3, locate the ground lug.
- a. Attach the longer ground wire with an eyelet on one end and a bullet connector on the other end to the lug and plug the wire into the control box.
  - b. Make sure you have a good contact on the lug and secure the wire.

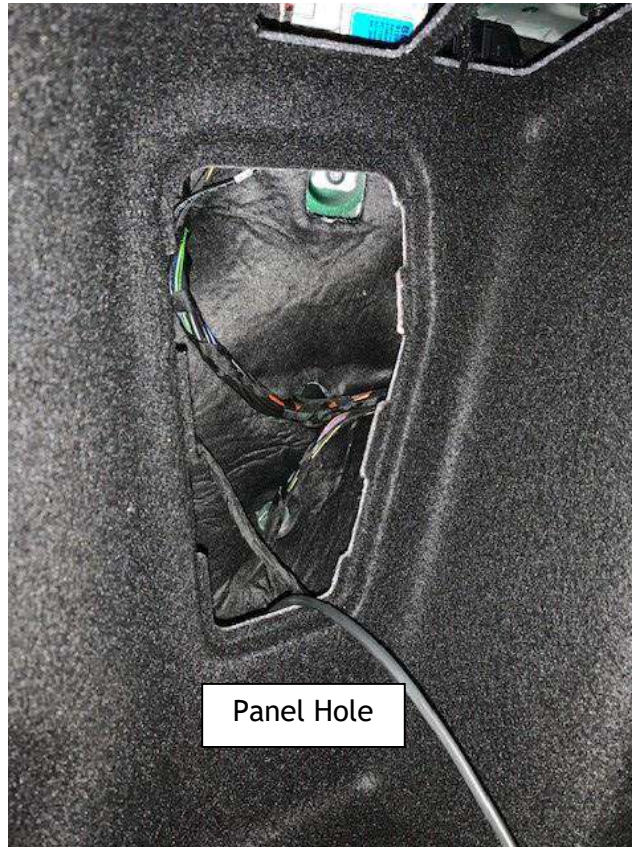

10) Check all wiring connections, attach zip ties where needed, and reinstall the trunk interior.



11) Underneath the car, support the exhaust and remove the nut for the hanger mount on the driver side, marked below.



- 12) Lightly sand and clean the hanger mount and attach the short ground cable to the hanger mount.  
a. Torque the hanger nut back in place.



- 13) Plug the exhaust valve motor in, leaving at least 1 inch of slack in the cable.
- Make sure the cable is not contacting anything sharp or hot.
  - To adjust cable length, pull or push cabling from the grommet.



- 14) Power the car on and test the key fob remote to ensure both the remote and the valve work properly.
- 15) Reinstall the screw in the wheel well from Step 1.
- 16) Installation is done.