



## OIL COOLER KIT INSTALLATION INSTRUCTIONS

PART NUMBER D570-0922

APPLICATION 2011-12 E92 335i/xi (N55 engine) with M-Technic bumper and stock oil cooler

Congratulations for being selective enough to use a Dinan Engineering Oil Cooler Kit. We have spent many hours developing this kit to assure that you will receive maximum performance and durability with minimum difficulty in installation. Please take the time to read these instructions and call us if you have any questions during the installation.



## **Important Note: All Cars**

This kit is designed for cars with the BMW M-Technic bumper. This kit will not fit cars equipped with the standard bumpers.

### **Important Note: Cars with ACC** (automatic cruise control)

Cars equipped with automatic cruise control require extra care when installing the Dinan oil cooler kit. When you loosen the radiator support assembly to install the new right side lower radiator mount / oil cooler mounts, mark the position of the nuts that hold it to the frame so you can install it in the same position. If you unplug the ACC sensor DO NOT turn the key ON, and make sure you plug it back in fully.

When the installation is complete, during your test drive check the operation of the ACC. If it does not function properly, you will have to adjust the sensor following BMW TIS instructions 66 31 001.

## INSTALLATION INSTRUCTIONS

1. Lift car and secure with jack stands if needed.
2. Remove the right front wheel to get clearance to the oil cooler.
3. Remove the front bumper. Start by removing four Torx screws (1) from bumper trim (2) as shown in **figure 1**.

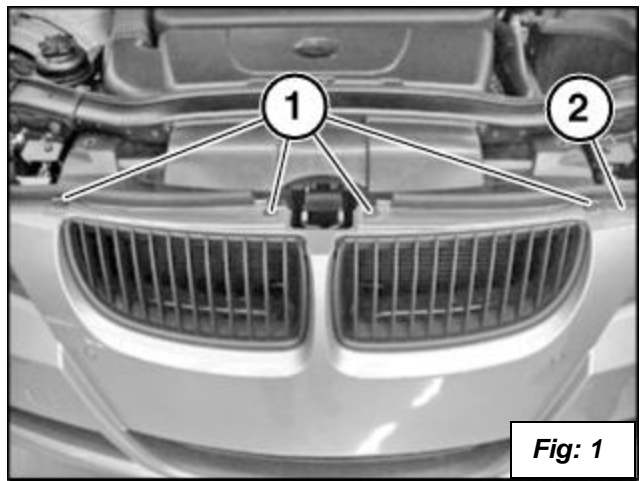

Fig: 1

4. Remove the front inner fender on the right side by removing the screws at location (1) and (2). Unscrew the nut at location (3). Remove the Air Guide (4). Disconnect the connector from the tire pressure box. **See figure 2**.

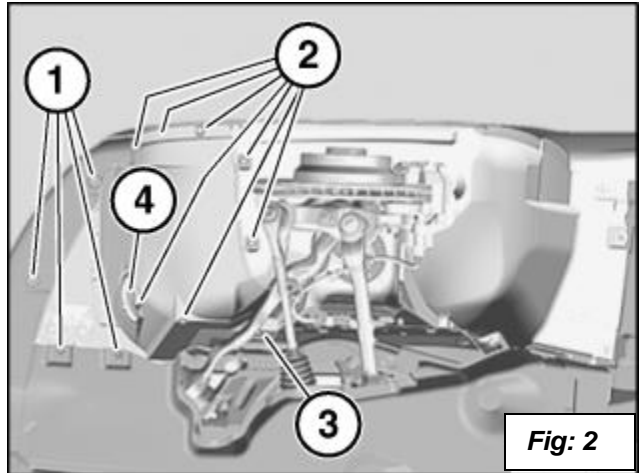

Fig: 2

5. On the left side remove the screws in location (1) and pry out the inner fender (2) to gain access to the two screws you will remove in the next step. **See figure 3**.

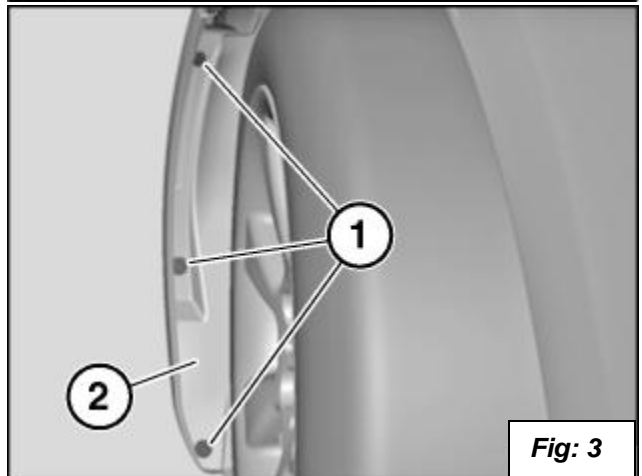

Fig: 3

6. Pry the inner fender (1) out of the way and remove the two screws (2) holding the bumper to the fender. **See figure 4**.

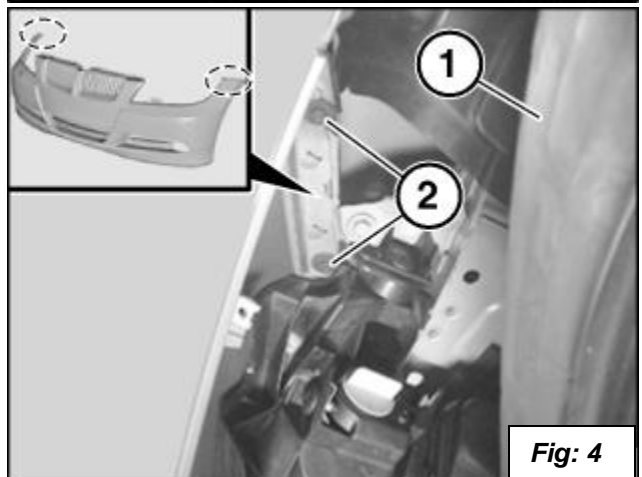
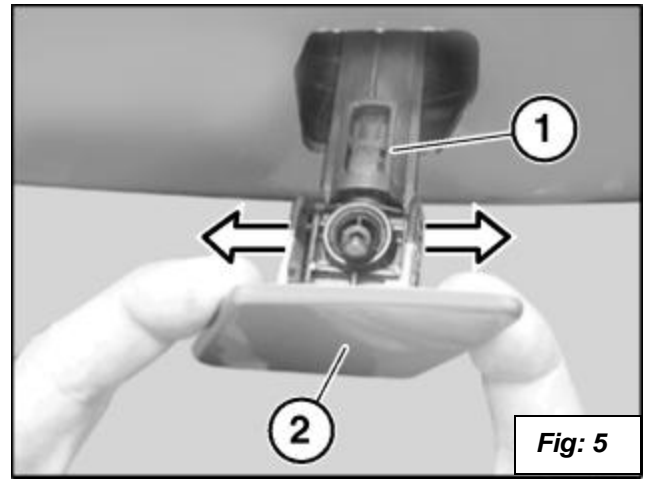

Fig: 4

7. Disconnect the fog light connector and parking sensor connector if equipped with them.

8. Remove the doors for the headlight cleaning system if your car is equipped with them. Pull out spray nozzle (1) by cover (2). Hold spray nozzle and carefully unclip cover sideways and remove. **Important! Do not let go of Spray Nozzle when removing Cover!** Grip spray nozzle firmly and slowly slide back into bumper after removing cover. Letting it slam back into bumper **will damage it!** See figure 5



9. Remove the screws in location (1) from the bumper (2). See figure 6.

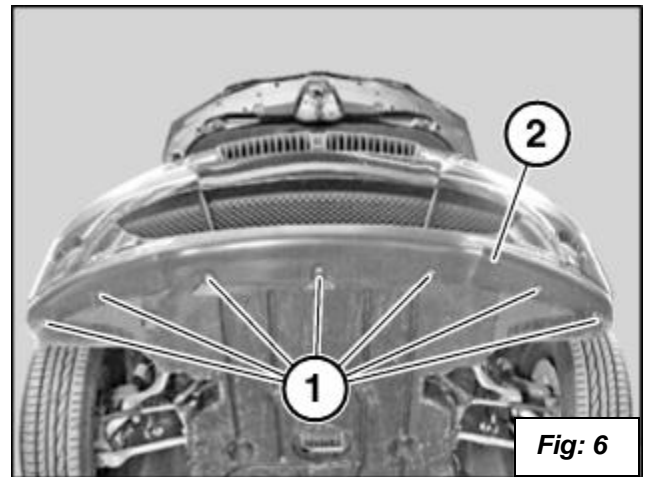

10. Prepare a safe place to put bumper after you remove it.

11. Remove bumper trim (1) with the aid of a second person by pulling out at top slightly and forward. See figure 7.

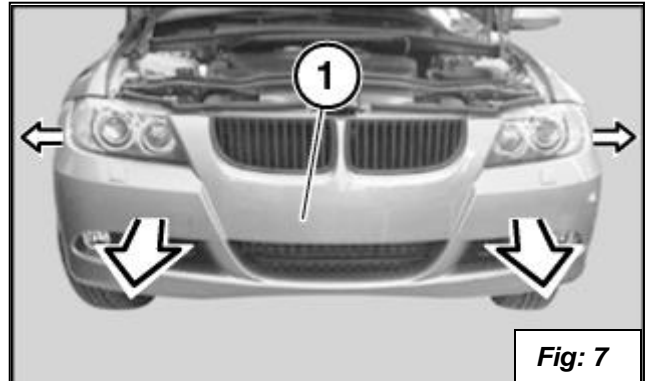

12. Remove the oil cooler. Start by putting a drain pan under the oil cooler where the lines attach. Remove the bolt holding the oil lines (1) to cooler. See figure 8.

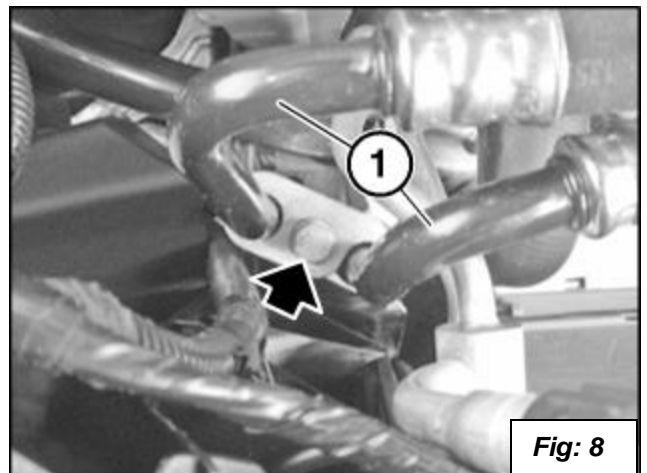

13. Remove the three screws marked with arrows that hold the duct to the oil cooler (3). See **figure 9**.
14. Remove the bolt (1) and the nuts (2) and save for installing on the new oil cooler. You will also need the rubber mounts **and top bracket and will remove them in step 24**. See **figure 9**.

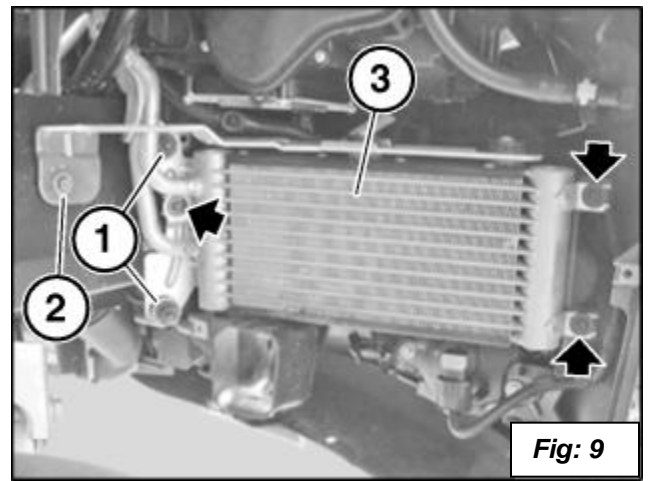

15. Remove the air duct (1) that goes from the top of the radiator to the air box by removing the screws (2). See **figure 10**.

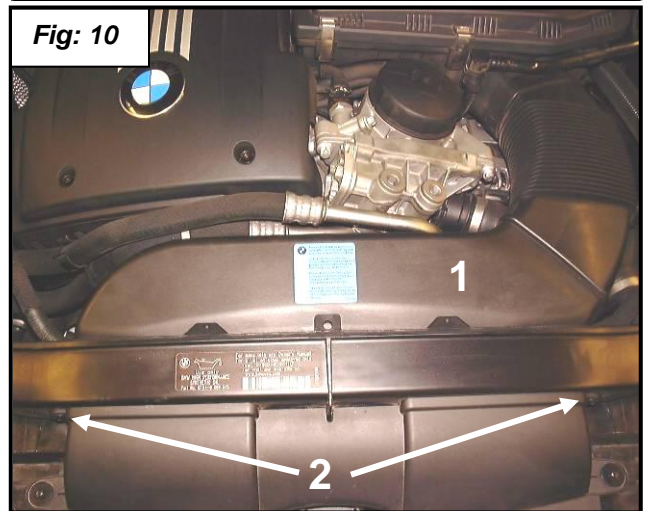

16. Remove the oil lines (1) from the oil filter control housing by removing the bolt marked with an arrow. Put rags under oil lines to catch oil (keep the oil off of the belts!). See **figure 11**. **Tip:** Use a flex head ratchet and you don't have to remove the fan cowl.

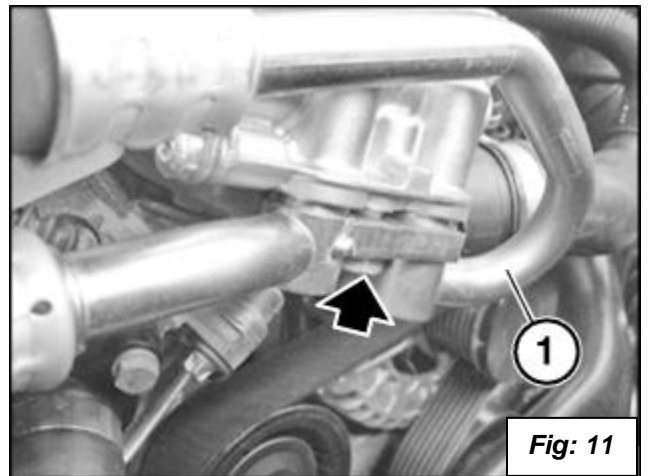

17. Remove the right brake duct by removing the mounting screw. See **figure 12**.

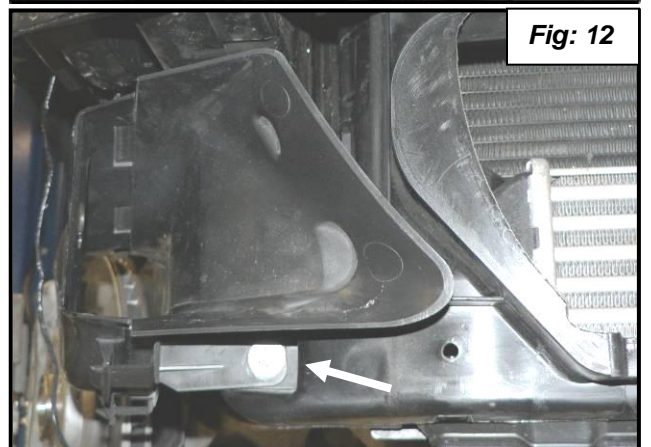

18. Mark the brake duct as shown in figures 13 and 14.

Fig: 13

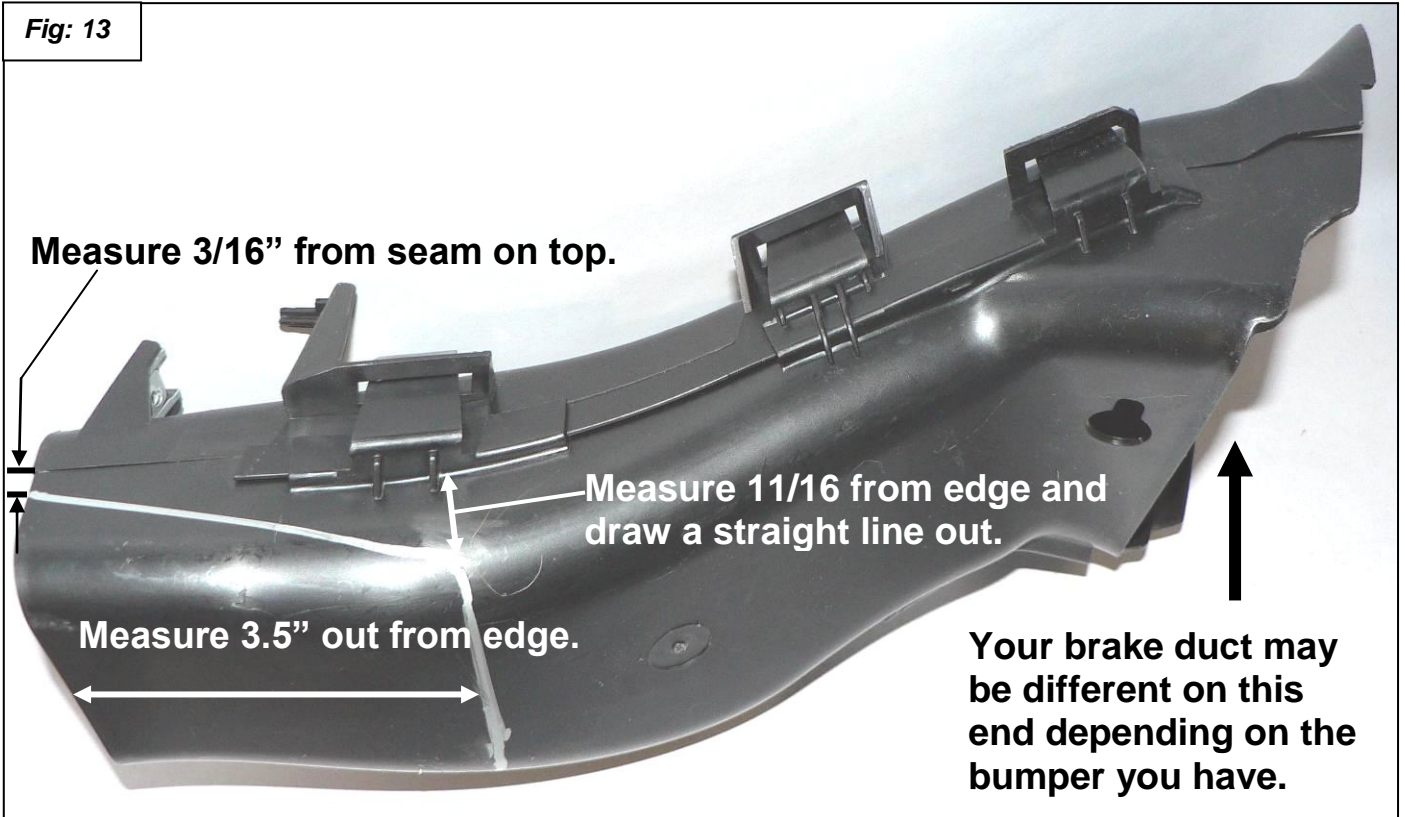
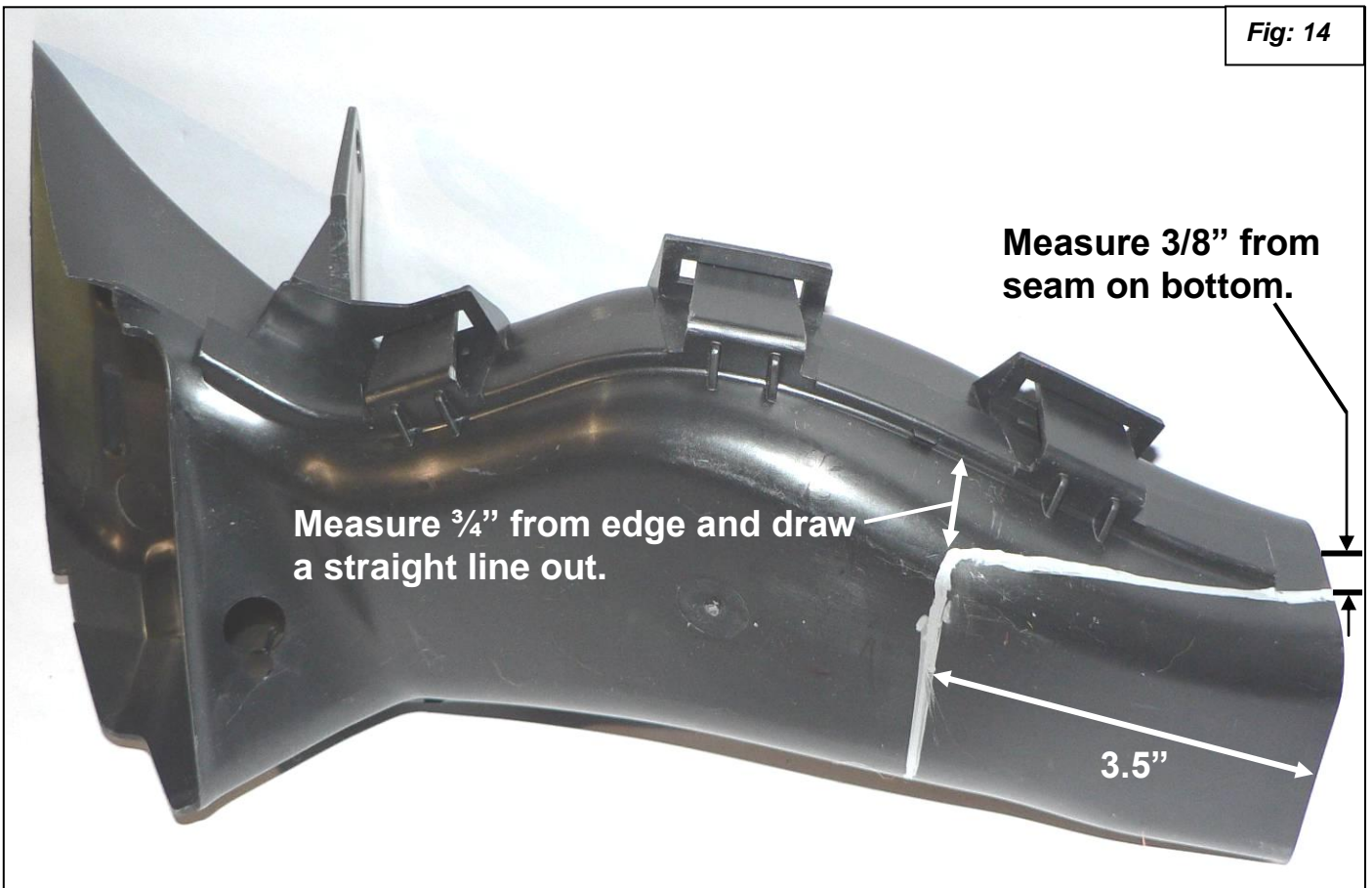

Fig: 14



19. Cut and deburr the brake duct as shown in **figures 15 and 16**.

**Fig: 15**

**Finished duct with edges filed smooth.  
Top view.**

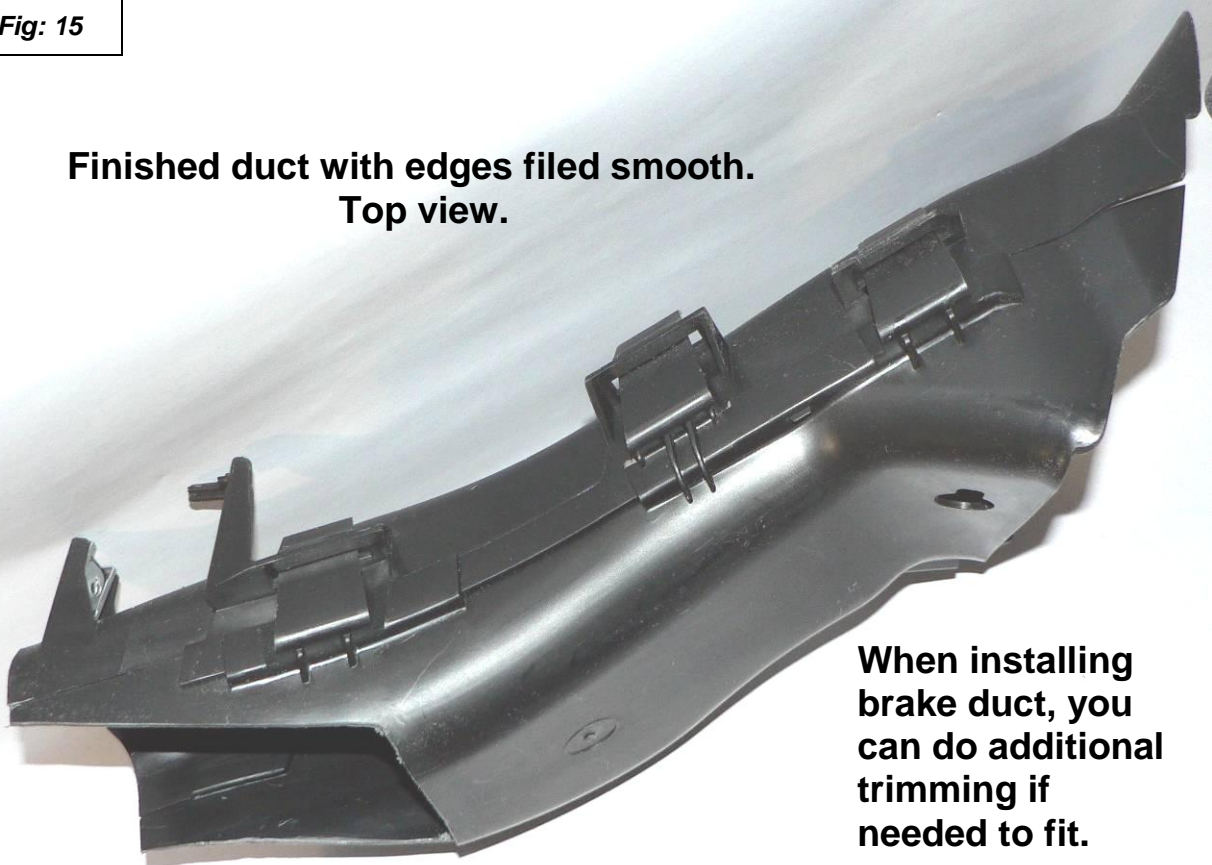

**When installing  
brake duct, you  
can do additional  
trimming if  
needed to fit.**

**Fig: 16**

**Finished duct with edges filed smooth.  
Bottom view.**

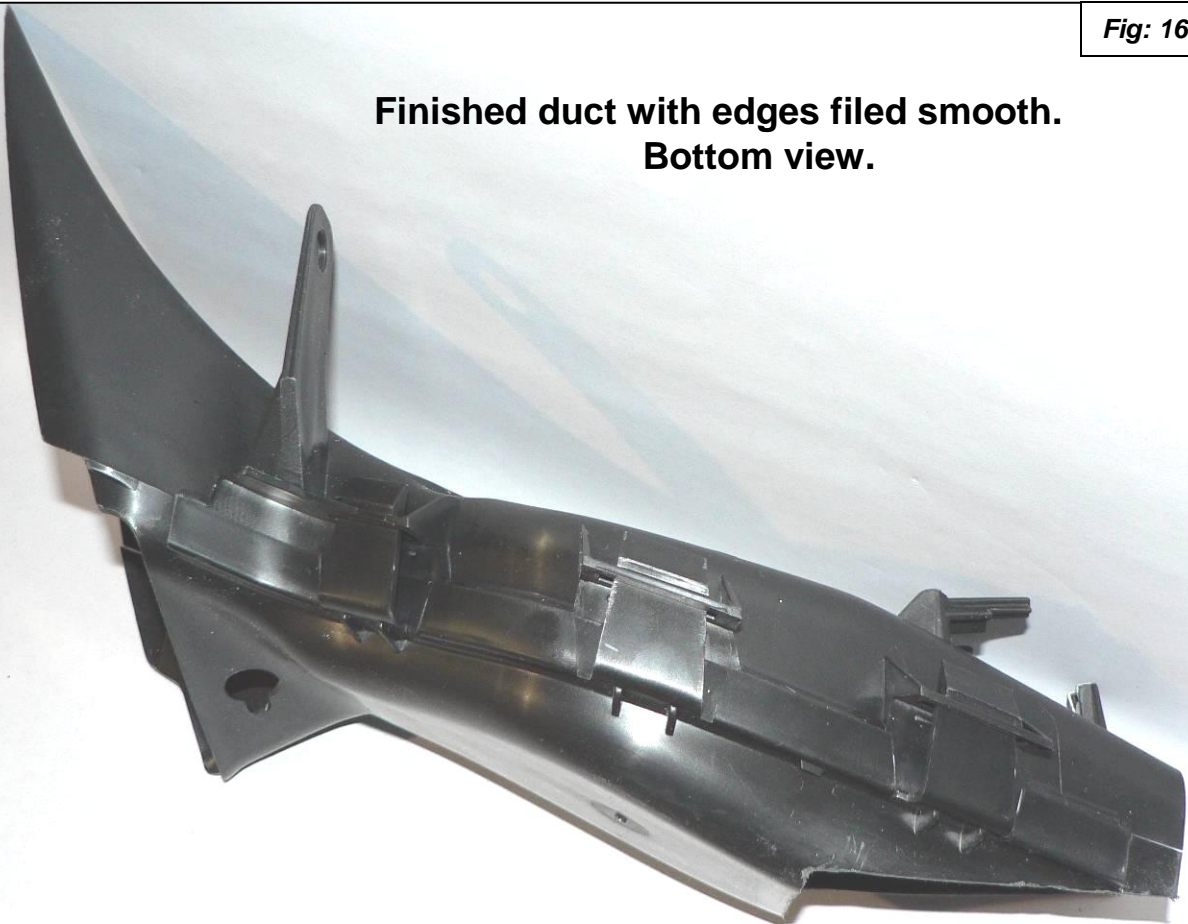

20. Remove the headlight support. Cut off the lower half of the plastic mount that the headlight support attached to. You will need the space for clearance for the oil cooler. **See figures 17 and 18.** Make sure you do not cut off the upper mount. You will need to replace the stock headlight support with the new Dinan headlight support, and attach it to the upper hole in step 30.

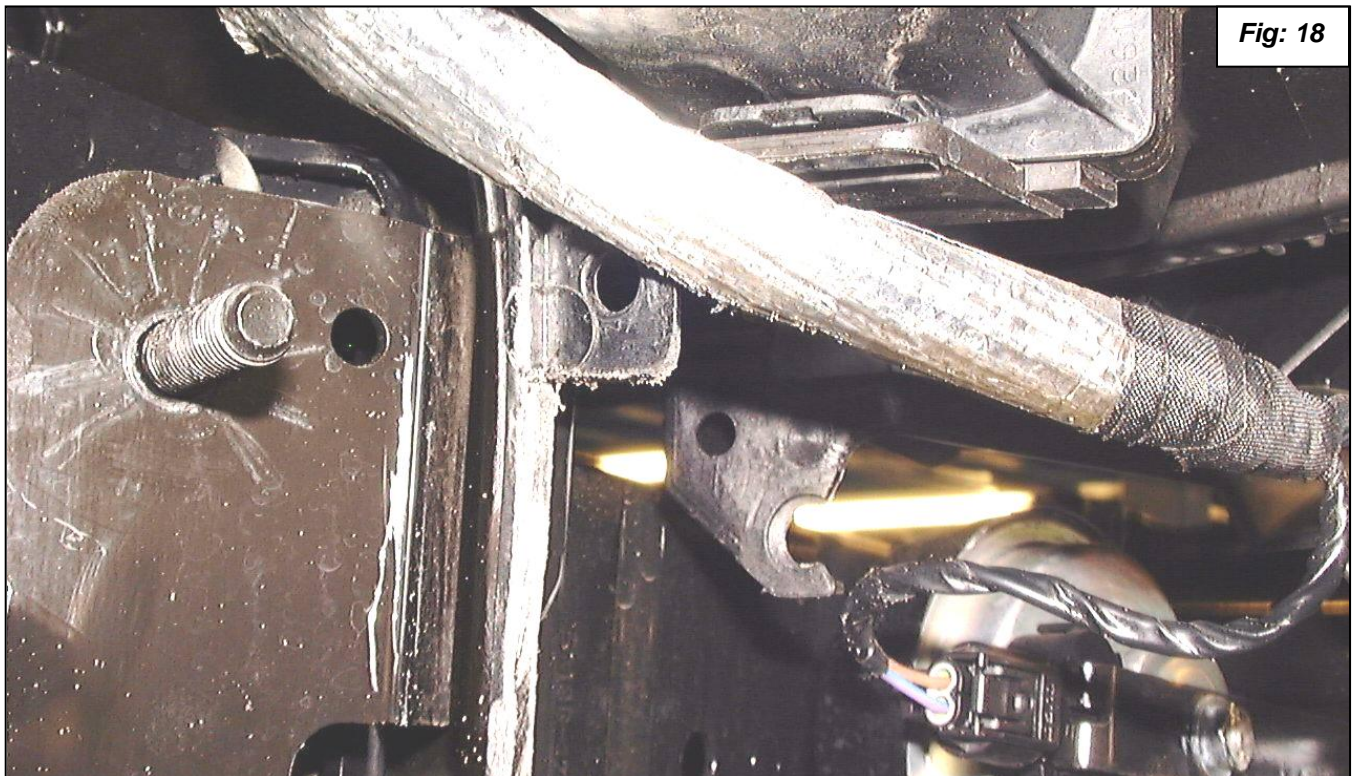
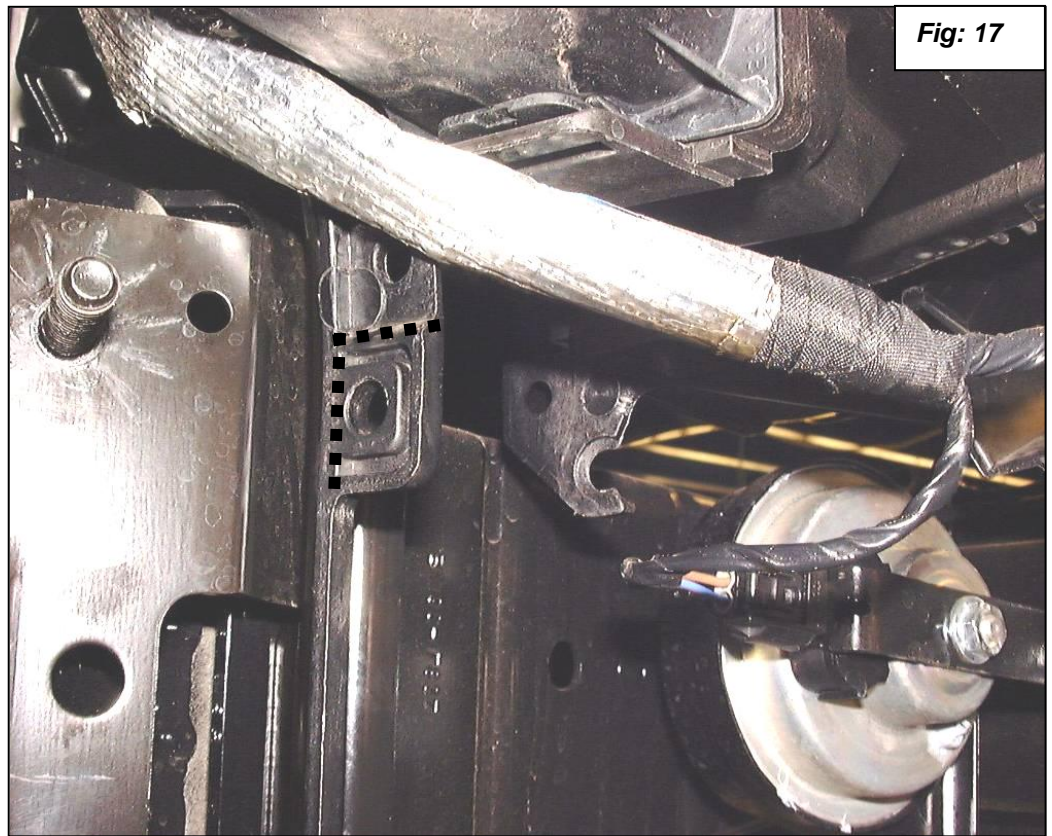



22. Remove the top support bracket from the stock oil cooler. The screws are tamper proof torx. If you do not have the correct tool to remove them, vise grip pliers will work in a pinch. **See figure 19.**



23. Draw a line on the top support bracket as shown in **figure 20**. File the point off the bracket for extra clearance for the oil hose as shown in **figure 21**.



24. Install the top support bracket onto the new Dinan oil cooler mount with the supplied 6mm x 10mm bolts and washers. Install the rubber mounts, and attach lower mounting tab with the included hardware. **See figure 22.**

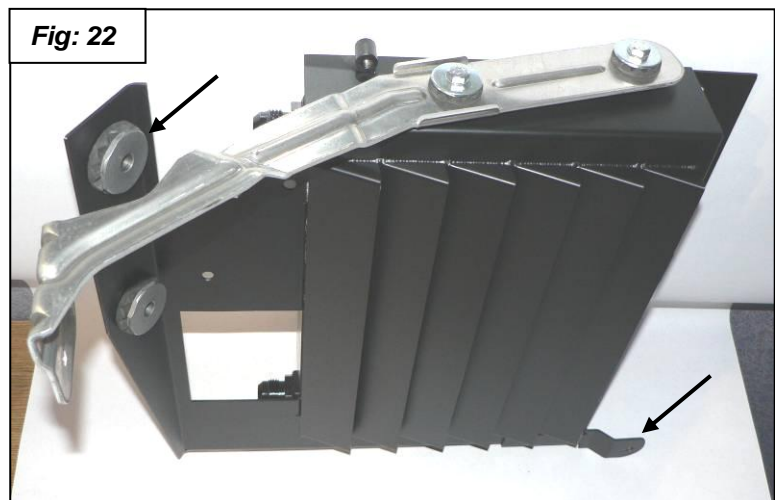

25. Replace the AC Line Support Bracket. To make room for the new Oil Cooler Hoses you will need to remove the stock plastic AC line support bracket from the front of engine. This bracket will be replaced by a new steel AC Line Support Bracket that relocates the AC line down and slightly forward. Pull the AC line out of the C-shaped tip of the stock support bkt. Remove bracket and save the single mounting bolt for the new support bracket. **See figure 23.**

26. Use the photo below to mount the new **AC Line Support Bracket** with the original bolt. Leave the mounting bolt loose enough that the Bracket can be easily rotated if necessary. The free end of this bracket should be just slightly higher than the mounted end or slightly up from level. Use the enclosed **#22 Loop Clamp, M6 x 16 bolt, M6 wave washer** and **M6 nylok nut** to attach the AC Line to the new Support Bracket. The goal is to lower the AC line about 2-1/2" at the swaged collar below the oil thermostat housing. You may want to leave the two bolts slightly loose until the Oil Lines are installed then tighten them when you are sure there is sufficient clearance, as they will still be easy to reach. Be careful to maintain about 1/2" or more clearance between the AC line and the rear of the auxiliary fan assembly at the closest point. You do not want the AC line to hit the fan assembly during hard braking. **See figure 24.**

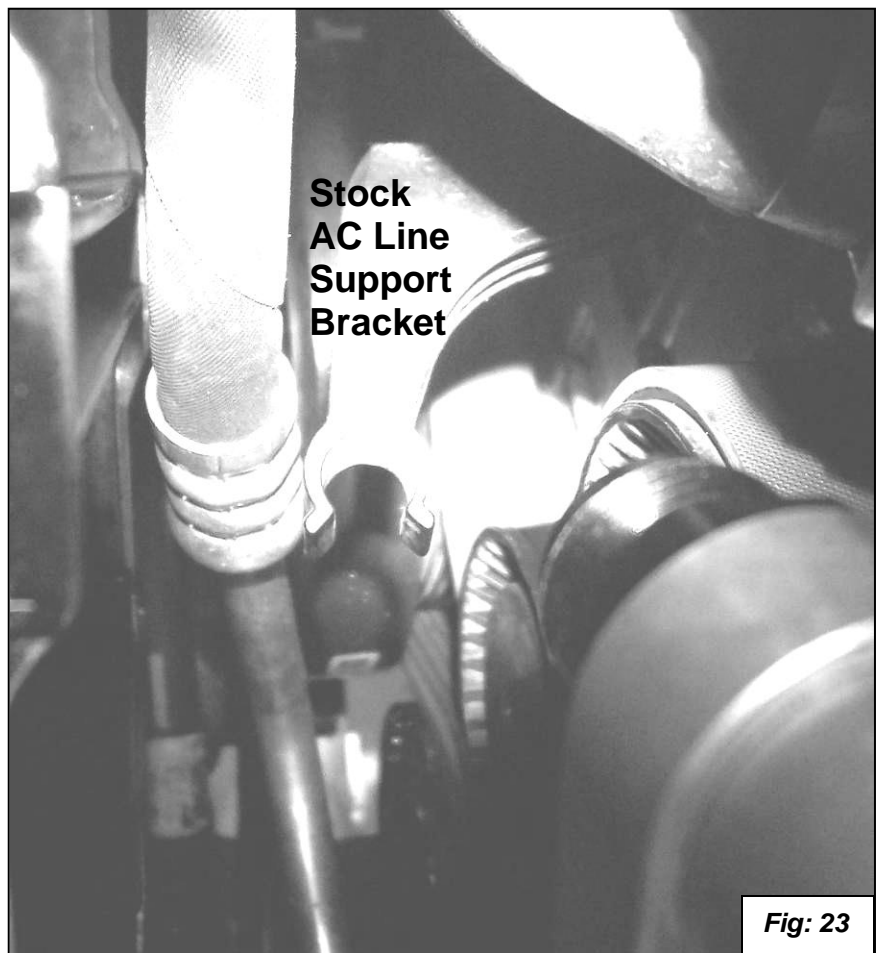

Fig: 23

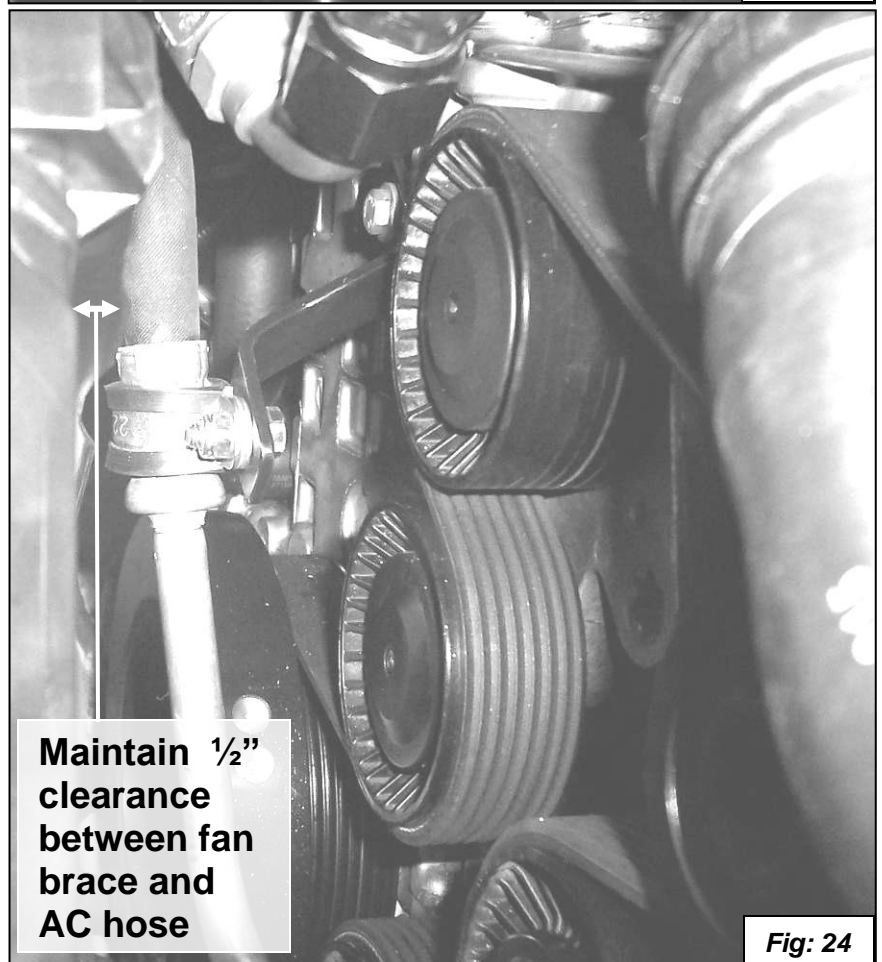

Fig: 24

27. Install the O-Rings onto the oil line adapter block. Put the 8mm x 25mm Allen head bolt and serrated lock washer in place. See **figure 25**



**Fig: 25**

28. Install the oil line adapter block onto the oil filter thermostat housing. Make sure the O-Rings don't get pinched as you install the block. Torque the bolt to 20Nm (15ft-lbs.). See **figure 26**.



**Fig: 26**

29. If your car had a stock headlight bracket and wire harness, do the next two steps.

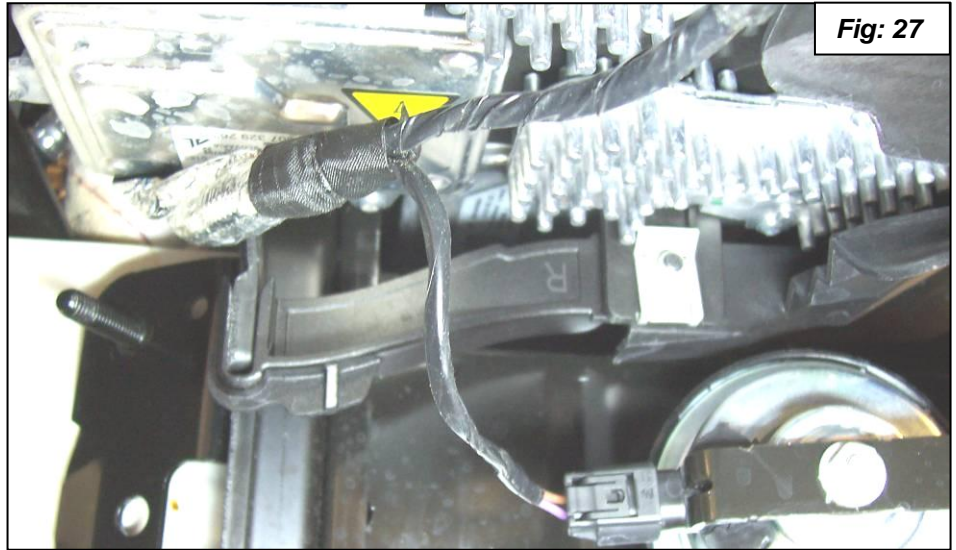

30. Install the Dinan headlight support bracket in place of the BMW bracket you removed in step 20. It fits between the headlight mount and the upper mount you did not cut off in step 20.
- Loosely attach the Bracket to the remaining mounting tab using an M6x16 bolt, two M6 fender washers and M6 nylok nut. For improved clearance with the wire harness, install the bolt pointing forward, so the nut is on the front side of the bracket.
  - Use the M6x16 bolt, M6x18 flat washer and M6 wave washer in the front hole.
  - You can start the front bolt using your fingertips -- one from below and one hand over the bumper mounting box-tube. Tighten the bolt with a M10 1/4" drive wobble-socket, long extension and ratchet. Lift up a little on the big rubber radiator inlet duct to see the bolt head. Now tighten the rear bolt, but do not over-tighten. See **figure 27**.

31. Use the 11" wire tie to pull the wire harness forward and inward **as shown in figure 28**. You can insert the wire tie tip into the small slot that is just forward and above the forward mounting bolt for the Support Bracket. See the circled spot below. Moving the harness protects it from the Oil Cooler Frame and the upper edge of the Air Duct Assy.

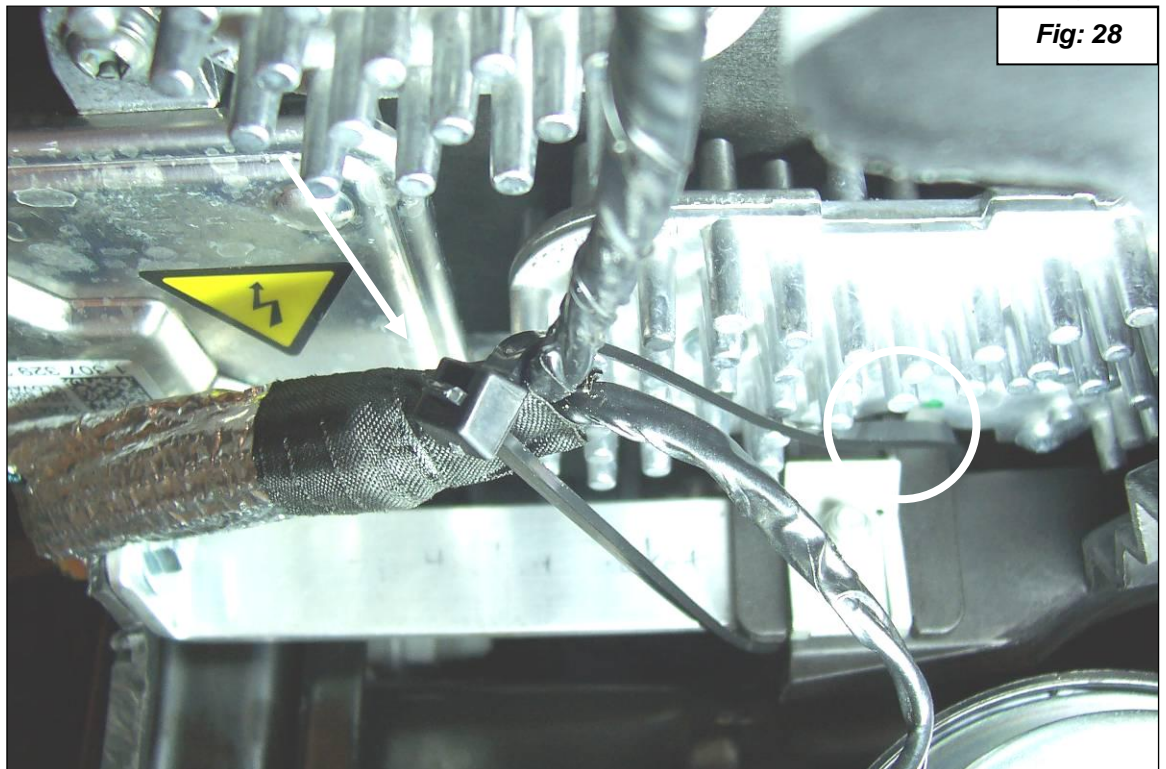

33. Loosely install the Upper Oil Line (oil line with the 90° fittings on each end) to the Cooler **as shown in figure 29**. One end has a swivel and one end doesn't. Install the **end without the swivel** onto the topside of the oil cooler. I like to apply a thin film of anti-seize compound to the threads and mating surface of each fitting before installing. Do not tighten yet. **Leave the aluminum Oil Cooler Retaining Strap on the Cooler Assy until after the Oil Lines are fully tightened.** The Retaining Strap temporarily holds the Oil Cooler in the correct position. Observe all of the Oil Line photos before installing them.



34. Refer to **figure 30** to see where to install three pieces of edge trim to protect the oil lines where they would otherwise rub on sharp edges. Proceed to the next step before mounting the Cooler Assy.

35. Route the oil line as shown in **figure 30**. Attach the Oil Cooler Assembly to the car as shown previously with the two stock 8mm nuts and the 6mm bolt. Torque nuts to 20Nm (15ft-lbs.) and bolt to 8Nm (6ft-lbs.).

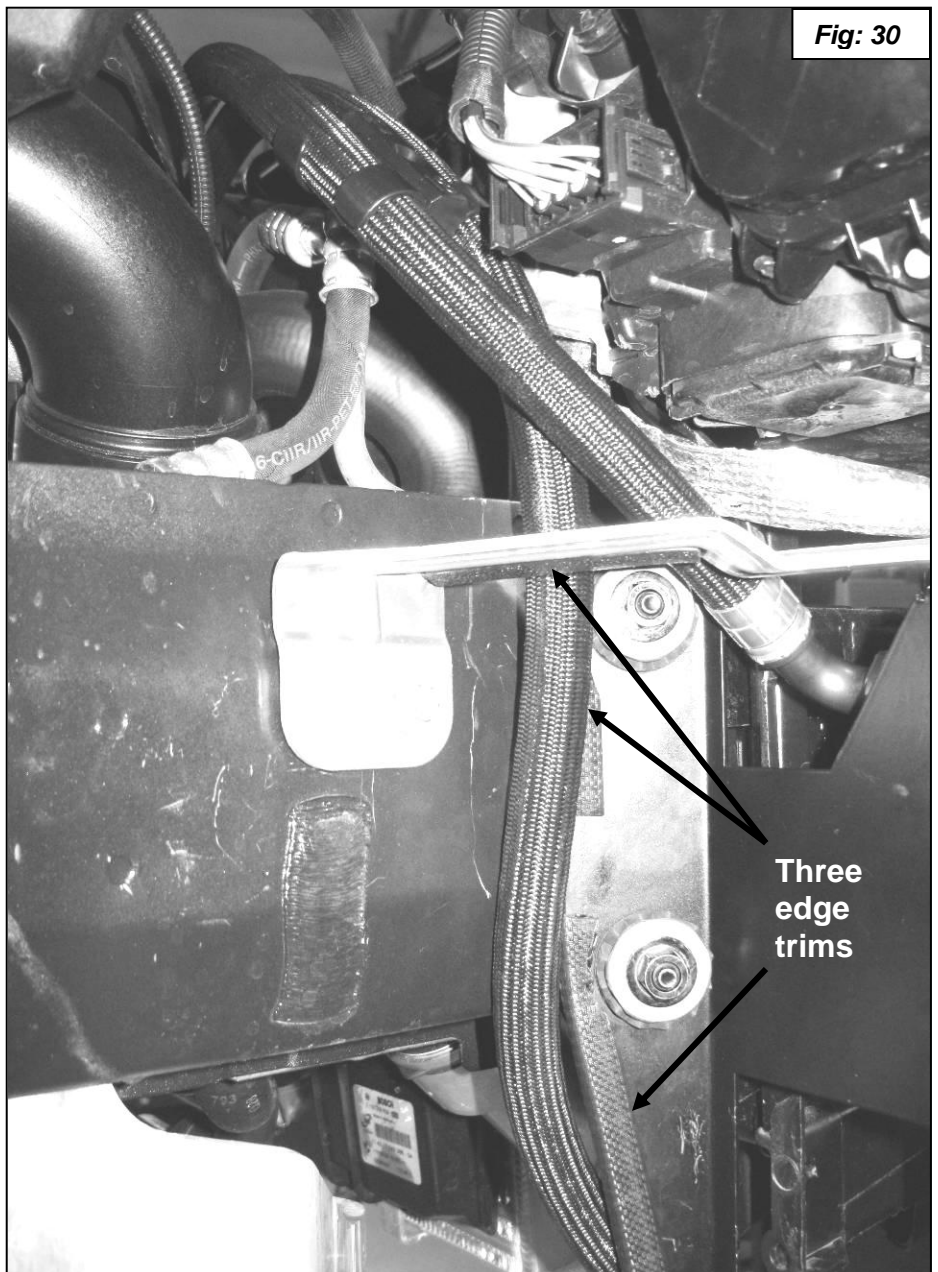

36. Connect the **non-swivel** end of the Lower Oil Line to the lower fitting on the Oil Cooler after routing the Line under the Upper Line as shown in **figure 31**. **Always start this type of fitting by hand for several turns before using a wrench to avoid cross-threading the aluminum threads.**

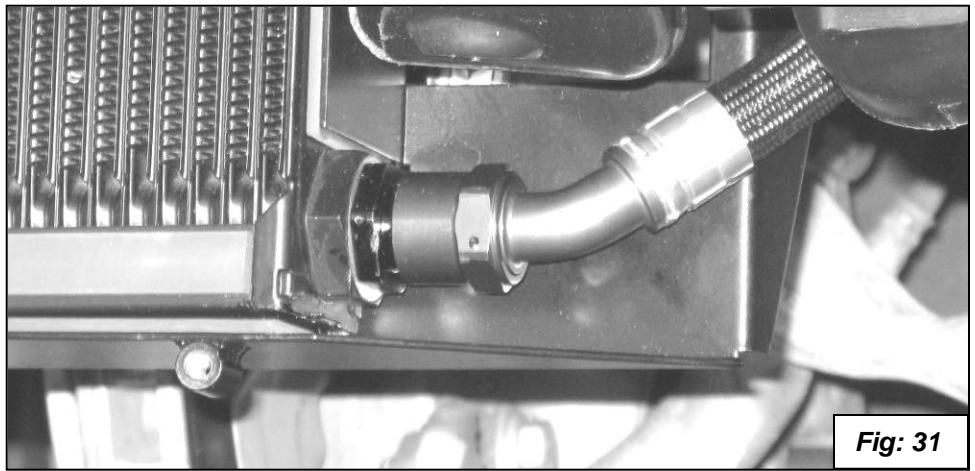

**Fig: 31**

37. Tighten the upper fitting so the fitting is centered between the headlight and the cooler support bracket. It is best to use one wrench on the line fitting and one on the Oil Cooler hex to protect the Oil Cooler.
38. Tighten the lower fitting so the rotating end of the fitting is about 1/8" from the Oil Cooler Frame. **Double-check the tightness of the fittings that connect to the Oil Cooler, as they will not be accessible after the Air Duct is installed on the oil Cooler.**



**Fig: 32**

39. Install the 90°-swivel end of Upper Oil Line onto the adapter as shown below. Tighten the fittings in a position that the fittings and hose do not rub on anything that has a sharp edge. **Tighten fittings with 2 wrenches, one on hose fitting and the other on fitting attached to adaptor block. Be sure to not loosen the adaptor fitting in this process!**
40. Connect the swivel-end of the Lower Oil Line to the adaptor as shown in **figure 32**. Tighten the fitting.
41. Notice the placement of the "Hose Pairing Clamp" shown in **figure 32**. Simply place the clamp between the two Oil Lines diagonally so the lines fit into the clamp at the same time then rotate until the lines snap into place. Check the entire routing of the lines and readjust if necessary so no sharp edges come in contact with the lines during normal engine movement. Again it is OK to rotate the hose swivels for best positioning. You may want to loosely secure one or both lines with a wire-tie to achieve the safest routing away from any sharp edges.

42. Install the modified brake duct and check for clearance. With the oil cooler in a relaxed position you should have about  $\frac{1}{2}$ " clearance as shown in **figure 33**.

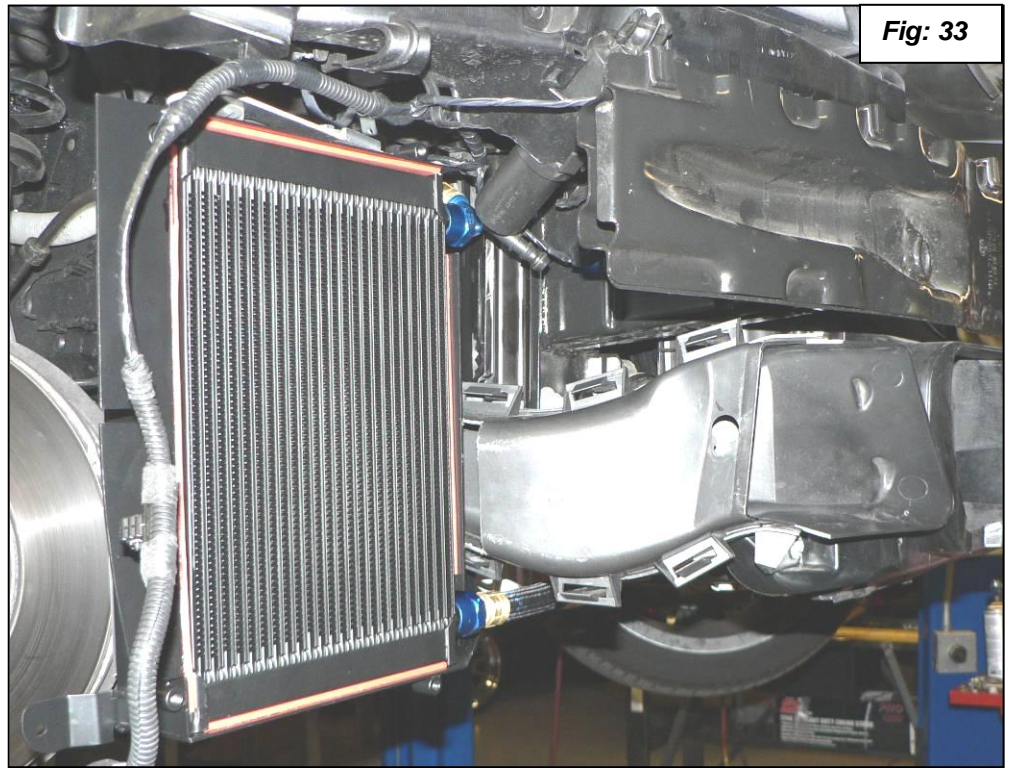

**Fig: 33**

43. When you pull the cooler into the position it will be with the bumper attached, and the clearance should be flush. **See figure 34**.

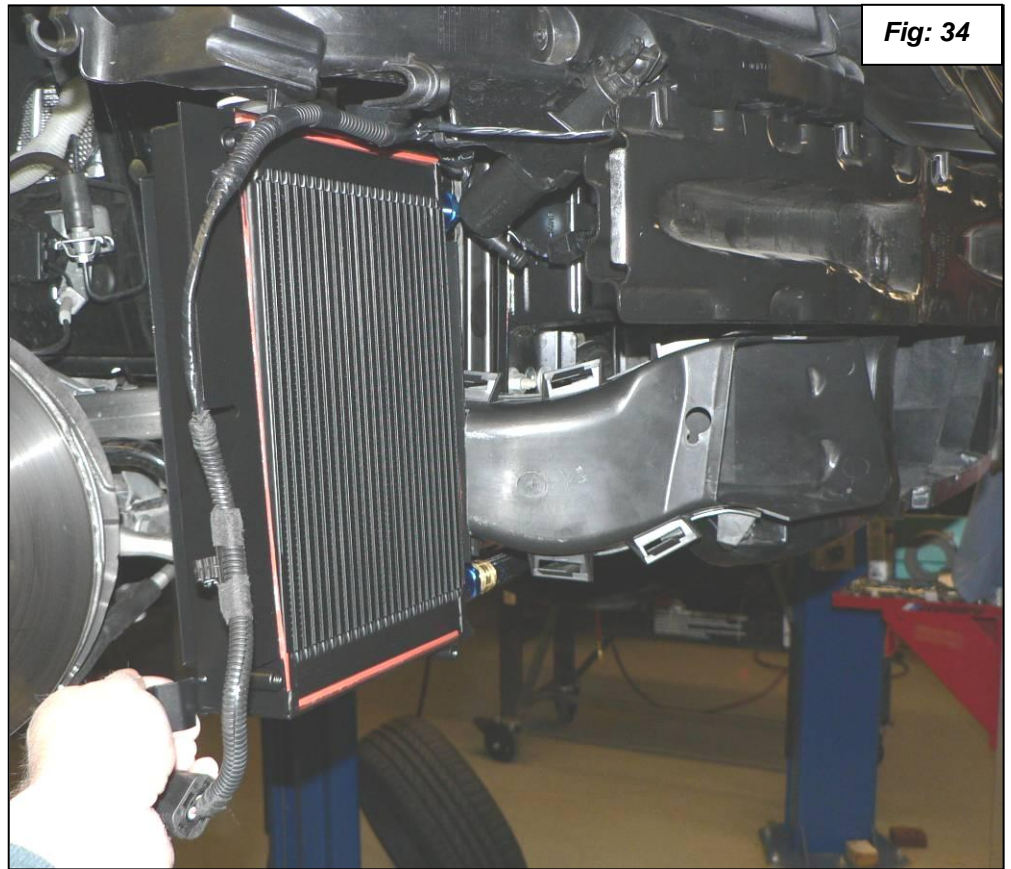

**Fig: 34**

44. It is a good idea to start the car and check for leaks after the oil has had a chance to circulate through the Cooler. After the Air Duct is installed you will not be able to tighten the fittings at the Oil Cooler.

45. Start engine and check closely for leaks. Run the engine at a constant speed of 2,500 rpm until the oil thermostat opens and the Oil Cooler outlet Fitting gets hot. This will take about 10 minutes or more. Let engine back to idle then check the engine oil level. You will probably need to add about ½ to 1 quart of the appropriate oil to engine.

46. You can now remove the aluminum Oil Cooler Retaining Strap on the Cooler Assy.

47. Install the air duct onto the oil cooler assembly with the four supplied 6mm x 12mm hex head bolts and wave washers. See **figure 35**. Cut the seal at the end of the bumper as shown in **figure 36**.

48. Pull the upper edge seal back far enough to put the rubber grommet around the wire for the fog light as shown in **figure 37**. If the wires have a corrugated cover on them they should still fit in the grommet.

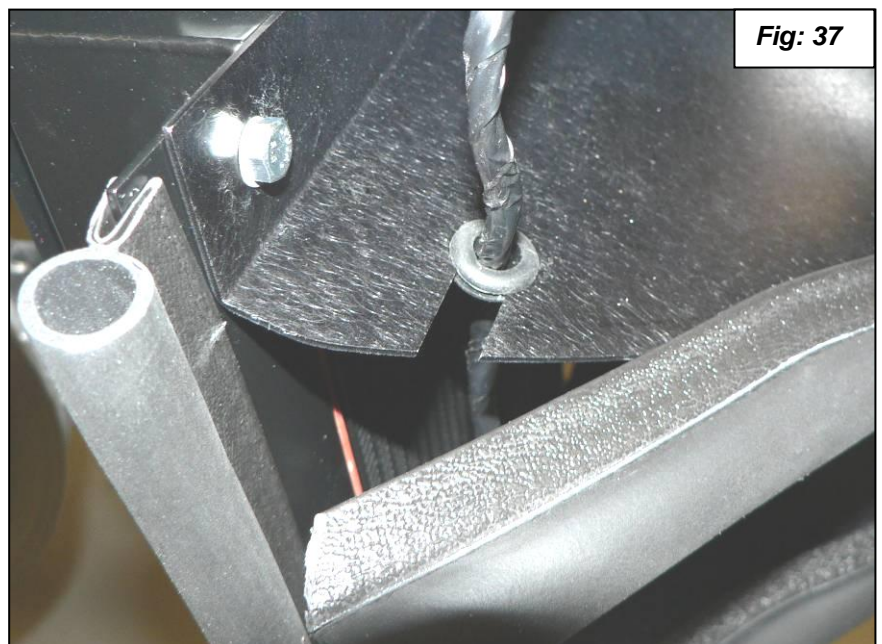
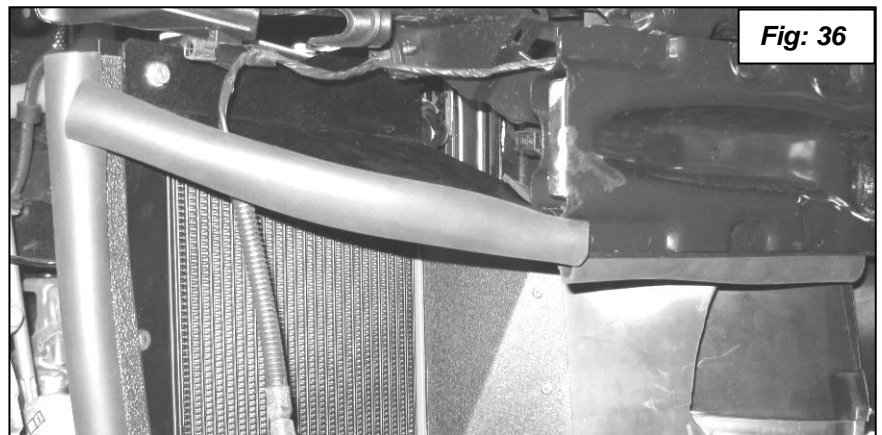
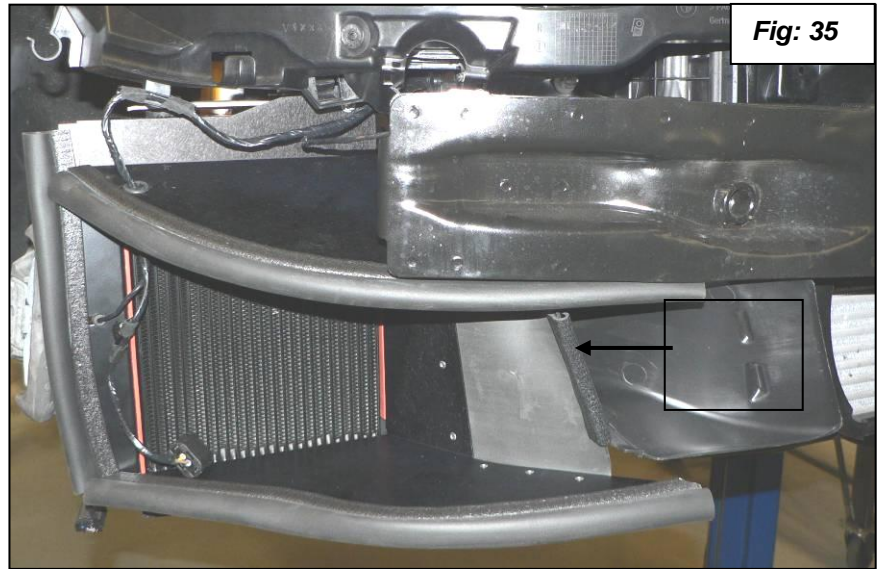



49. Fasten the top screws (1) as shown in **figure 38** and the side screws (2) as shown in **figure 49**.

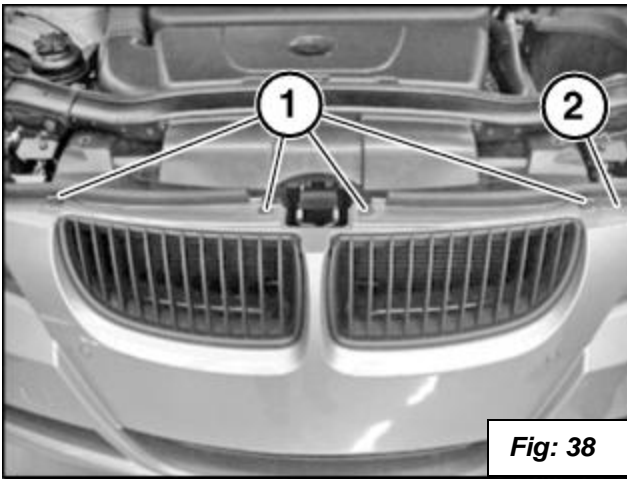

**Fig: 38**

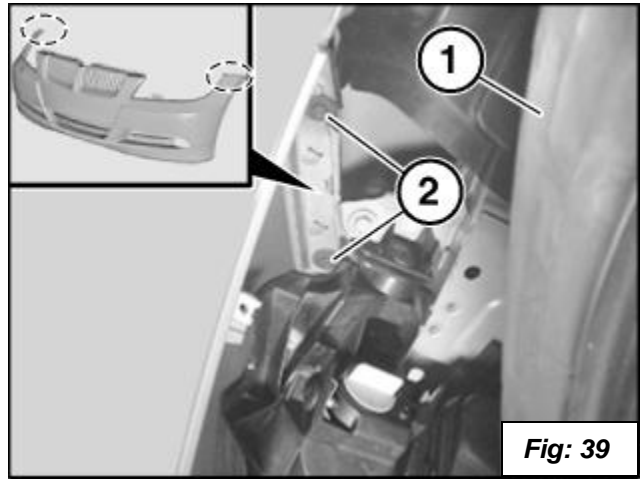

**Fig: 39**

50. Fit the inner fender into position and mark as shown in **figure 40** so you can enlarge the opening for the oil cooler vent.

51. Remove inner fender and cut as marked.



**Fig: 40**

Cut straight down  
along outside of  
louvers to 1.5" from  
bottom.

52. You will need to trim the support ribs at the bottom of the inner fender as shown in **figure 41**.

**Fig: 41**



53. Cut the stock louvers as shown in **figures 42 and 43**.

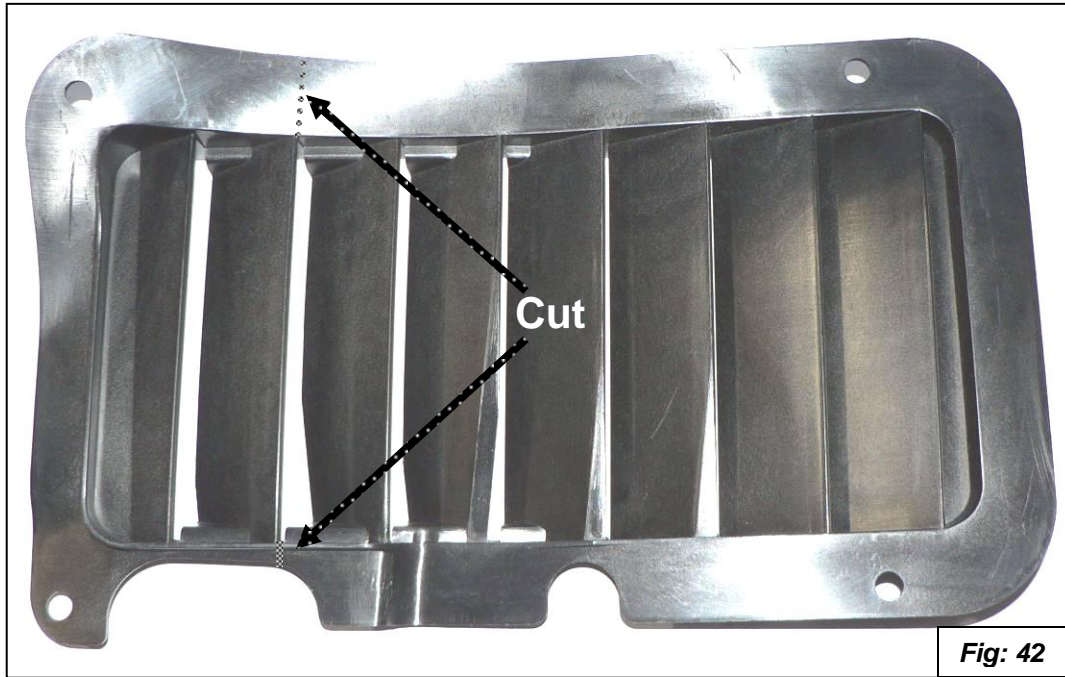

54. Install the inner fender. Install the modified louvers. **See figure 44.**
55. Install the other inner fender and bumper screws that you removed in the first steps.
56. Install the right front wheel and torque to 120Nm (89 ft-lbs.).

Enjoy.

