

## 1970 DODGE CHALLENGER

Four panel Sequential [LED Taillight kit](#) installation guide

### Kit Contents:

- **4** LED panels
- **4** rubber grommets
- **1** power wire with t-tap
- **2** driver side LED harnesses, 24"
- **2** passenger side LED harnesses, 48"
- **4** LED extension harnesses, 12"
- **2** harness crimp kits
- **8** mounting brackets

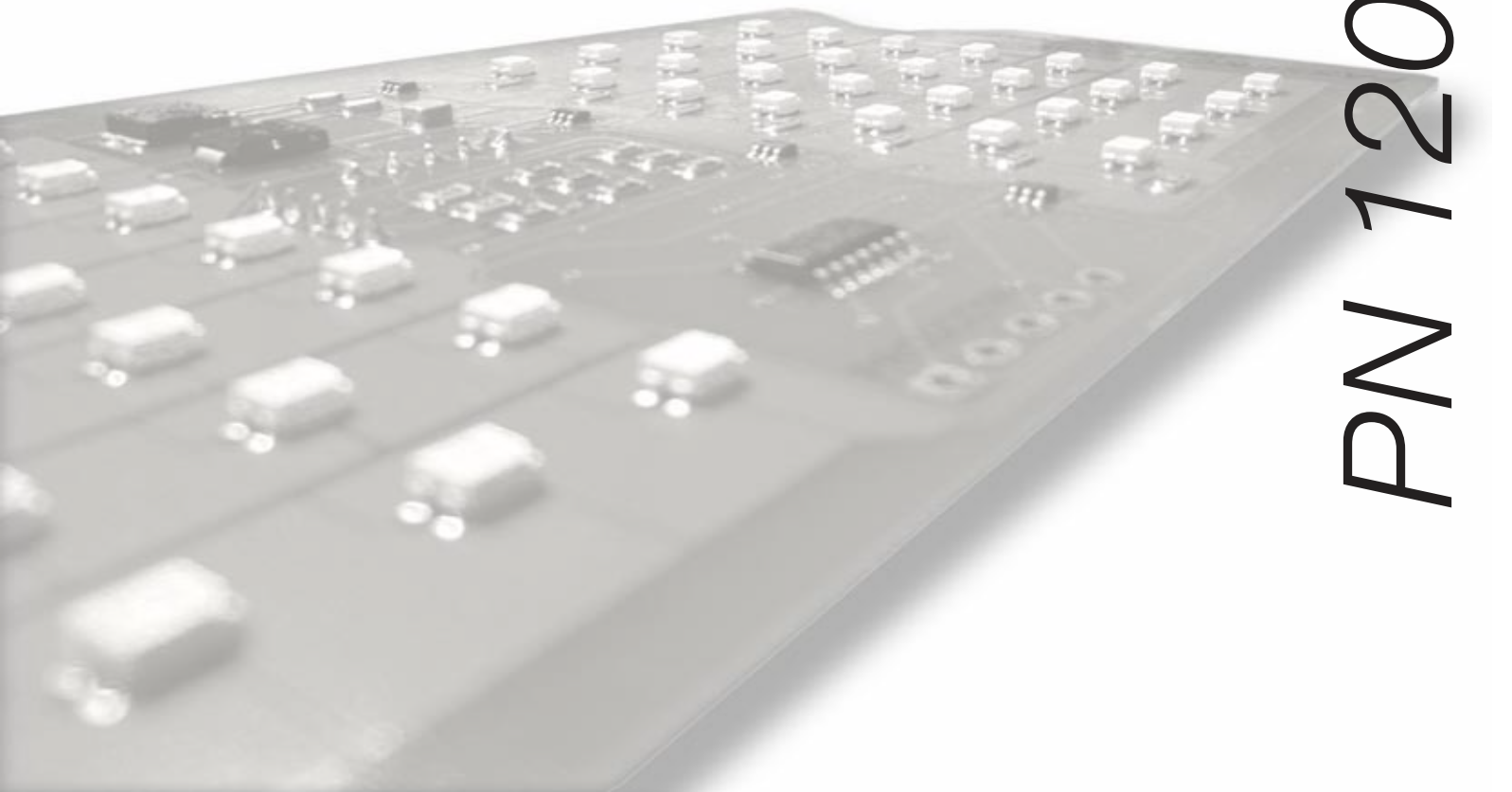

PN 1200170

## Note

The LED boards are shipped with the slide switch set to Sequential mode. We recommend that all slide switches be set to the same setting (either standard or sequential).

Please follow all local laws concerning exterior lighting.

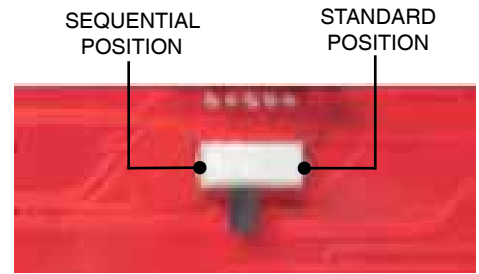

Shown in sequential mode

## Hint

You may begin with the LED panel installation, however, you will need to complete the wiring modifications before the LED panels and housings are paired as one. Read over the entire instruction guide to determine the method that works best for you.

# LED PANEL INSTALLATION

## 1. Cut off the power to your car.

Open the hood of your car. Disconnect the negative terminal from the battery, which will cut off the power in your car. To verify that the power is disconnected, press the brake pedal; your brake lights should not turn on.

## 2. Remove the current taillights.

Turn the light sockets counter-clockwise to remove them from the taillight housings. As a safety precaution, remove the bulbs from the sockets. Put them aside since they will no longer be needed. Remove the taillight housing assembly from the car.

## 3. Position the LED panels.

Each LED panel is marked Driver Side and Passenger Side on the backside of the LED panel, which identifies where each respective LED panel is to be mounted.



The Driver Side Outer LED panel is shown above.

### 4. Attach mounting brackets.

Each light pocket on the tail light housing needs to be marked for placement of the right angle brackets. To do this first flip the housing upside down, then from the edge of the housing measure back 1/2" and mark a parallel line.

The face of the bracket should be flush to this line. Remove the protective tape and carefully position the bracket into place. Each pocket gets two brackets.



Measure 1/2" from edge.

### 5. Mount the LED panels.

Test fit the LED panels into place before they are permanently attached to the brackets. Be certain that all LED panels are parallel with the housing edge then peel of the remaining protective tape and affix the LED panels.



### 6. Plug in extension harnesses.

Feed the extension harness through the socket hole and plug them onto the LED panels. Using these extension harnesses allows for easy removal of the taillight assembly if needed in the future.



## WIRE SPLICING INSTALLATION

**1. Review the wiring diagrams found on the last page.**









Each LED panel needs five connections. Listed are the LED harness colors and their respective function. Note: Depending on make and harness, colors may not match.

- ORANGE** - Constant 12 volt power source.
- BLACK** - Grounded to body.
- YELLOW** - Running/parking light signal.
- GREEN** - Driver side turn signal.
- BROWN** - Passenger side turn signal.

**2. Find and access the taillight wires.**

Pick a point in the rear body panel between the driver's side quarter panel and the driver's side taillight housing assembly and remove the cloth tape to expose the taillight wires.

**3. Splice the LED SIGNAL wires into the stock SIGNAL wires. Match the LED harness to the corresponding stock harness as shown below.**

LED Harness	Function	Stock harness	Notes
 Brown	Passenger side turn signal	 Brown	The light socket ends on the car harness can be removed.
 Green	Driver side turn signal	 Green	The light socket ends on the car harness can be removed.
 Yellow	Running/Park signal	 Black	Running light wires. <b>THIS IS NOT THE CAR'S GROUND.</b>
 Orange	Constant 12 volt		Find power at fuse panel/trunk light/dome light/fused battery feed.
 Black	Ground		Ground to Body/chassis.

**4. Connect all the ground wires.**

Connect all the ground wires together. Bolt them to the trunk latch support along with the original rear body harness ground. The ground connection must be good in order to the operate the LED tail lights.

**5. Supply the LED panel harnesses with a constant 12 volt feed using the included Orange power wire and T-Tap.**

An Orange power wire is supplied along with a T-Tap. The orange power wire must be powered with a constant 12 volt battery supply for the LED circuitry to operate properly. You can use the included T-Tap connector to splice to a constant power source, like the dome light, trunk light, fuse box, etc.

Splice the T-Tap connector over the constant power source, then plug the orange wire into the T-Tap. The other end of the orange power wire is tied in with the orange wires of all the LED panel harnesses.



1. Insert wire into T-Tap



2. Crimp with pliers



3. Plug connector into T-Tap

**6. Tuck and secure the spliced wires.**

Take the spliced sections and fold them over to one side and tape them in place. This will allow you to place the wiring into loom or wrap the LED panel wiring tightly away.



1. Fold wires to one side.



2. Secure with electrical tape.

**Note**

*A wire diagram of the LED panel's harness spliced into the car's stock harness is on the last page.*

**7. Place the grommet around the wires and replace the lens.**

Place the grommet around the panel wires and press it into the light socket hole. Test the lights to ensure correct function, then place the lens back onto the housing.



Grommet in position.

**Note**

*The LED light kits are designed for best performance when use an electronic no-load flasher. Shown here is an optional electronic no load flasher available from DIGI-TAILS, ( PN 20-F2 )*



*If you decide to use a stock bi-metal flasher, we recommend a standard-duty flasher instead of a heavy-duty flasher. If your turn signal circuit includes front and rear LED turn signals, the circuit will not have enough resistance load to operate a heavy-duty bi-metal flasher, so the no-load flasher will be required for both the turn signal and emergency flashers.*

# 1970 DODGE CHALLENGER

# WIRE SPLICING INSTALLATION

STOCK  
REAR BODY  
HARNESS

STOCK HARNESS COLORS.  
BROWN: GREEN: BLACK

ALTHOUGH CLOSED END CONNECTORS ARE INCLUDED, IT IS RECOMMENDED THAT ALL SPLICED WIRES BE SOLDERED TOGETHER FOR THE BEST CONNECTION RELIABILITY.

**POWER CONNECTION**  
CONSTANT FUSED POWER SOURCE.  
(AT DOME LIGHT OR FUSE PANEL)  
DRAWS LOW CURRENT, LESS THAN  
3 AMPS.

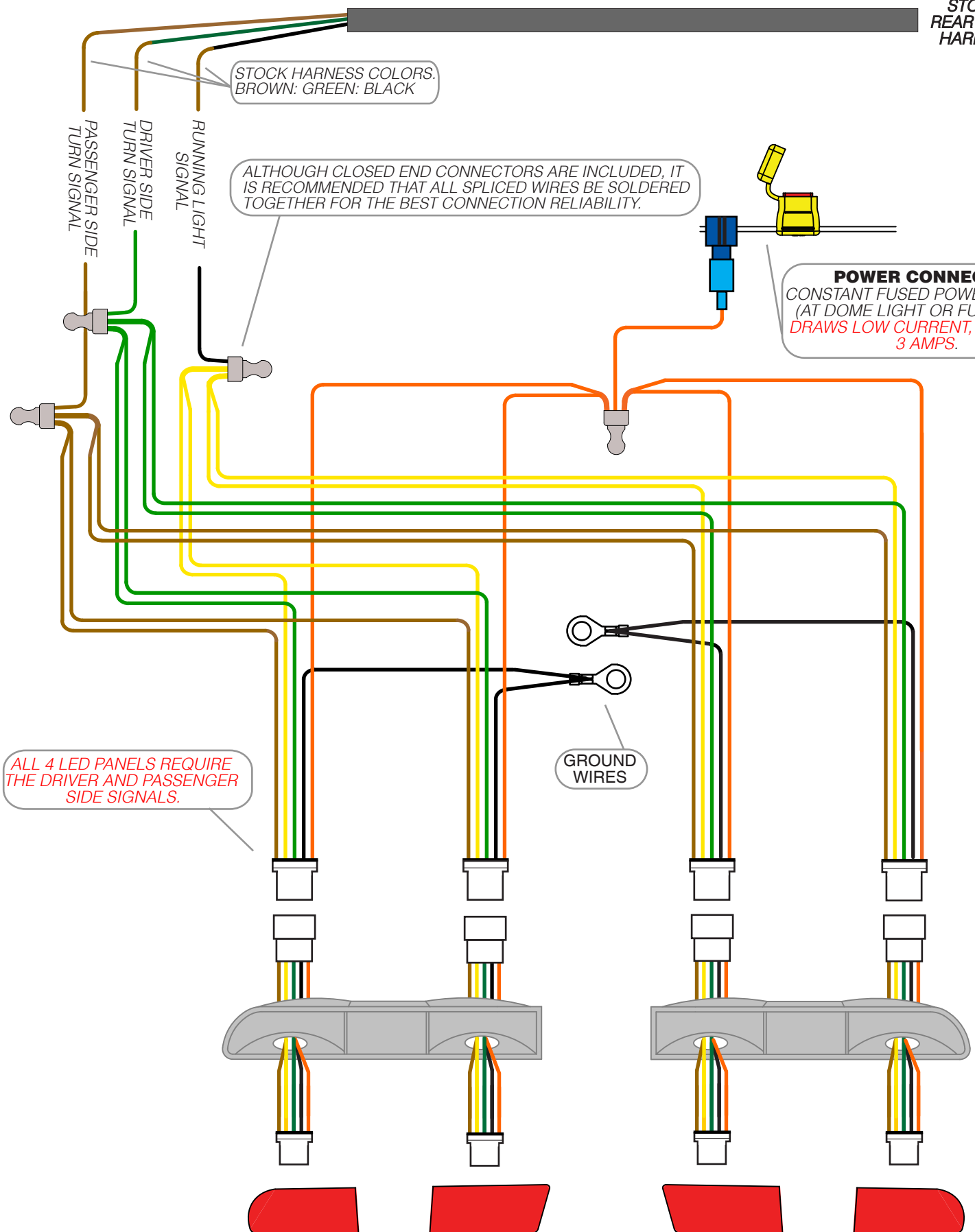

ALL 4 LED PANELS REQUIRE THE DRIVER AND PASSENGER SIDE SIGNALS.

DRIVER SIDE LED PANELS

PASSENGER SIDE LED PANELS