

1981-88 CUTLASS SUPREME

Two panel Sequential LED Taillight kit installation instructions

Kit Contents:

- **2** LED panels
- **1** power wire with t-tap
- **1** driver side LED harnesses, 24"
- **1** passenger side LED harnesses, 48"
- **2** LED extension harnesses, 12"
- **1** harness crimp kit
- **1** mounting kit

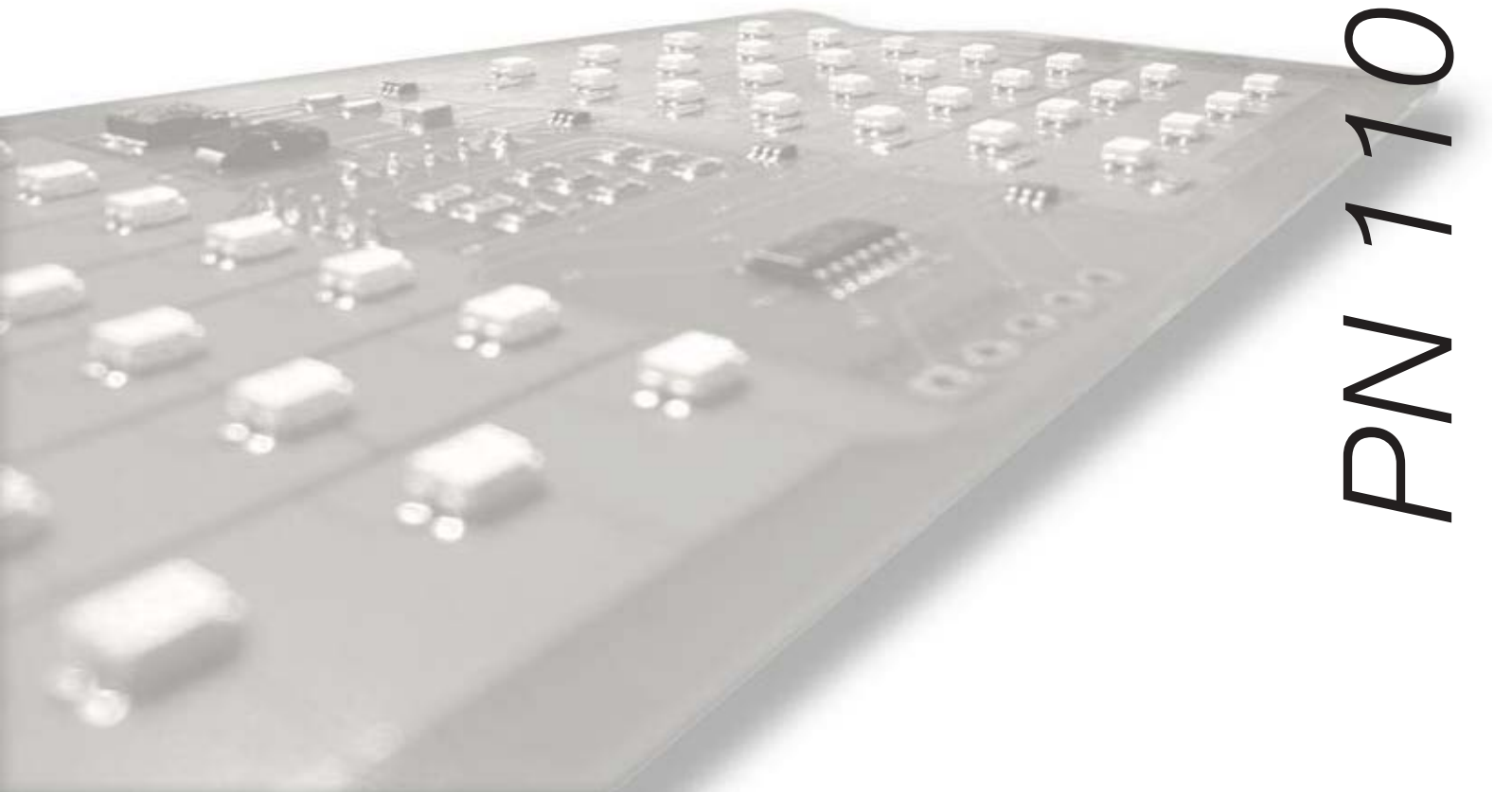

PN 1101281

Note

The LED boards are shipped with the slide switch set to sequential mode. We recommend that all slide switches be set to the same setting (either standard or sequential).

Please follow all local laws concerning exterior lighting.

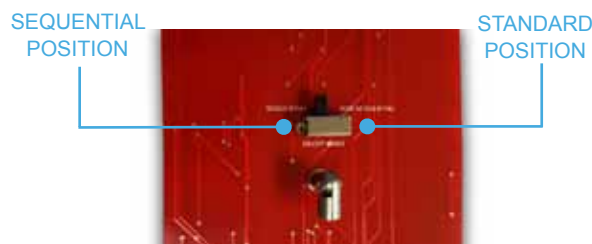

Shown in sequential mode

Hint

You may begin with the LED panel installation, however, you will need to complete the wiring modifications before the LED panels and housings are paired as one. Read over the entire instruction guide to determine the method that works best for you.

LED PANEL INSTALLATION

1. Cut off the power to your car.

Open the hood of your car. Disconnect the negative terminal from the battery, which will cut off the power in your car. To verify that the power is disconnected, press the brake pedal; your brake lights should not turn on.

2. Remove the tail lights.

Turn the light sockets counter-clockwise to remove them from the tail light housings. As a safety precaution, remove the bulbs from the sockets. Put them aside since they will no longer be needed. Remove the tail light housing assembly from the car.

3. Modify the tail light housings.

Remove the tail light housing assembly from the car. You will need to cut out a rectangular slot on the bottom side of the housing. Doing so will allow you to slide in the LED panel. Take your time marking the measurements. It is also best to slowly trim away the necessary plastic.

1. Place tape on the bottom end of the housing. This will allow you mark the needed area to cut out.

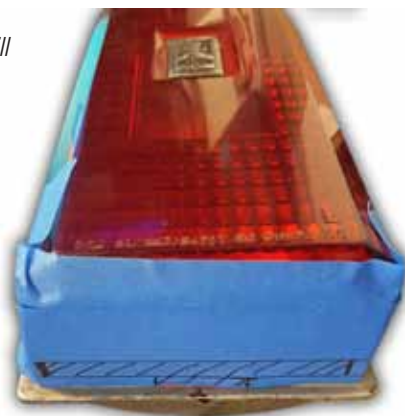

2. Cut out the included templates. There are separate templates for the DRIVER and PASSENGER sides.
3. Place the appropriate template on the taped end of the housing. Line it up with the edges of the housing, tape it in place, and mark the cut out area. Repeat on the opposite side.



DRIVER SIDE housing

4. Use a cut off wheel or a Dremel cutting wheel. I found Dremel #543 to work best.



5. Peel off the tape, file the cut edges if needed. Clean out any dust and plastic debris.



6. Test fit sliding the LED panel into the housing. The LED panel will rest on the inner plastic of the housing.

Its final position will have the LED panel bracket sit flush against the housing.



4. Mount the LED panels.

When mounting the LED panel make sure it sits flat and within the housing. Use the mounting hardware to secure the LED panel. Use silicone to seal around the LED panel bracket.

1. Once you feel the fit is satisfactory, plug the extension harness into the LED panel and slide the panel into the housing.



2. Pull the other end of the extension harness through the socket hole. Use the included grommet and wrap it around the wires and press it into the socket hole.



Hint 1

You may need to trim away part of the grommet so it fits properly into the socket hole.



Hint 2

It is best to use a small flat head screw driver to work the grommets onto the socket holes.

3. Look through the upper socket hole and locate the mounting hinge. Holding the housing upside down, screw the included stud into the hinge.



4. Install the remaining hardware to hold the LED panel in place.



Feed grommet around the stud and press the grommet into place sealing the socket hole.

Place the large steel washer and then the plastic white washer on top of the grommet

Tighten snug with black wing nut

Important Note

DO NOT OVER TIGHTEN THE WING NUT! Make sure that the LED panel is not bending in from too much tightening force. You may want to use Loctite or silicone to make to be sure the wing nut stays secure.

3. After the LED panel is in place and you have tested the lights the lights to confirm everything works as intended, add silicone around the perimeter of the bracket.



Completed housing assembly



Apply silicone

WIRE SPLICING INSTALLATION

1. Review the wiring diagrams found on the last page.

Each LED panel needs five connections. Listed are the LED harness colors and their respective function. Note: Depending on make and harness, colors may not match.

ORANGE - Constant 12 volt power source.

BLACK - Grounded to body.

YELLOW - Driver side turn signal.









GREEN - Passenger side turn signal.

BROWN - Running light signal.

2. Find and access the taillight wires.

Pick a point in the rear body panel between the driver's side quarter panel and the driver's side taillight housing assembly and remove the cloth tape to expose the taillight wires.

3. Splice the LED SIGNAL wires into the stock SIGNAL wires. Match the LED harness to the corresponding stock harness as shown below.

LED Harness	Function	Stock harness	Notes
 Green	Passenger side turn signal/ Brake light signal	 Green	The light socket ends on the car harness can be removed.
 Yellow	Driver side turn signal/ Brake light signal	 Yellow	The light socket ends on the car harness can be removed.
 Brown	Running/Park signal	 Brown	The light socket ends on the car harness can be removed.
 Orange	Constant 12 volt		Find power at fuse panel/trunk light/dome light/fused battery feed.
 Black	Ground		Ground to Body/chassis

Note about brake lights

There is no dedicated Brake light signal wire. When the brake pedal is pressed the brake switch sends power into the turn signal switch and then power through both the driver and passenger signal wires to activate the brake lights.

4. Connect all the ground wires.

Connect all the ground wires together. Bolt them to the trunk latch support along with the original rear body harness ground. The ground connection must be good in order to operate the LED tail lights.

5. Supply the LED panel harnesses with a constant 12 volt feed using the included **Orange** power wire and T-Tap.

An Orange power wire is supplied along with a T-Tap. The orange power wire must be powered with a constant 12 volt battery supply for the LED circuitry to operate properly. You can use the included T-Tap connector to splice to a constant power source, like the dome light, trunk light, fuse box, etc.

Splice the T-Tap connector over the constant power source, then plug the orange wire into the T-Tap. The other end of the orange power wire is tied in with the red wires of all the LED panel harnesses.



1. Insert wire into T-Tap



2. Crimp with pliers



3. Plug connector into T-Tap

6. Tuck and secure the spliced wires.

Take the spliced sections and fold them over to one side and tape them in place. This will allow you to place the wiring into loom or wrap the LED panel wiring tightly away.



1. Fold wires to one side.



2. Secure with electrical tape.

Note

A wire diagram of the LED panel's harness spliced into the car's stock harness is on the last page.

Note

The LED light kits are designed for best performance when use an electronic no-load flasher. Shown here is an optional electronic no load flasher available from DIGI-TAILS, (PN 20-F2)



If you decide to use a stock bi-metal flasher, we recommend a standard-duty flasher instead of a heavy-duty flasher. If your turn signal circuit includes front and rear LED turn signals, the circuit will not have enough resistance load to operate a heavy-duty bi-metal flasher, so the no-load flasher will be required for both the turn signal and emergency flashers.

STOCK
REAR BODY
HARNESS

STOCK HARNESS COLORS.
BROWN: GREEN: YELLOW

ALTHOUGH CLOSED END CONNECTORS ARE INCLUDED, IT IS RECOMMENDED THAT ALL SPLICED WIRES BE SOLDERED TOGETHER FOR BEST CONNECTION RELIABILITY.

POWER CONNECTION
CONSTANT FUSED POWER SOURCE.
(AT DOME LIGHT OR FUSE PANEL)
DRAWS LOW CURRENT, LESS THAN
3 AMPS.

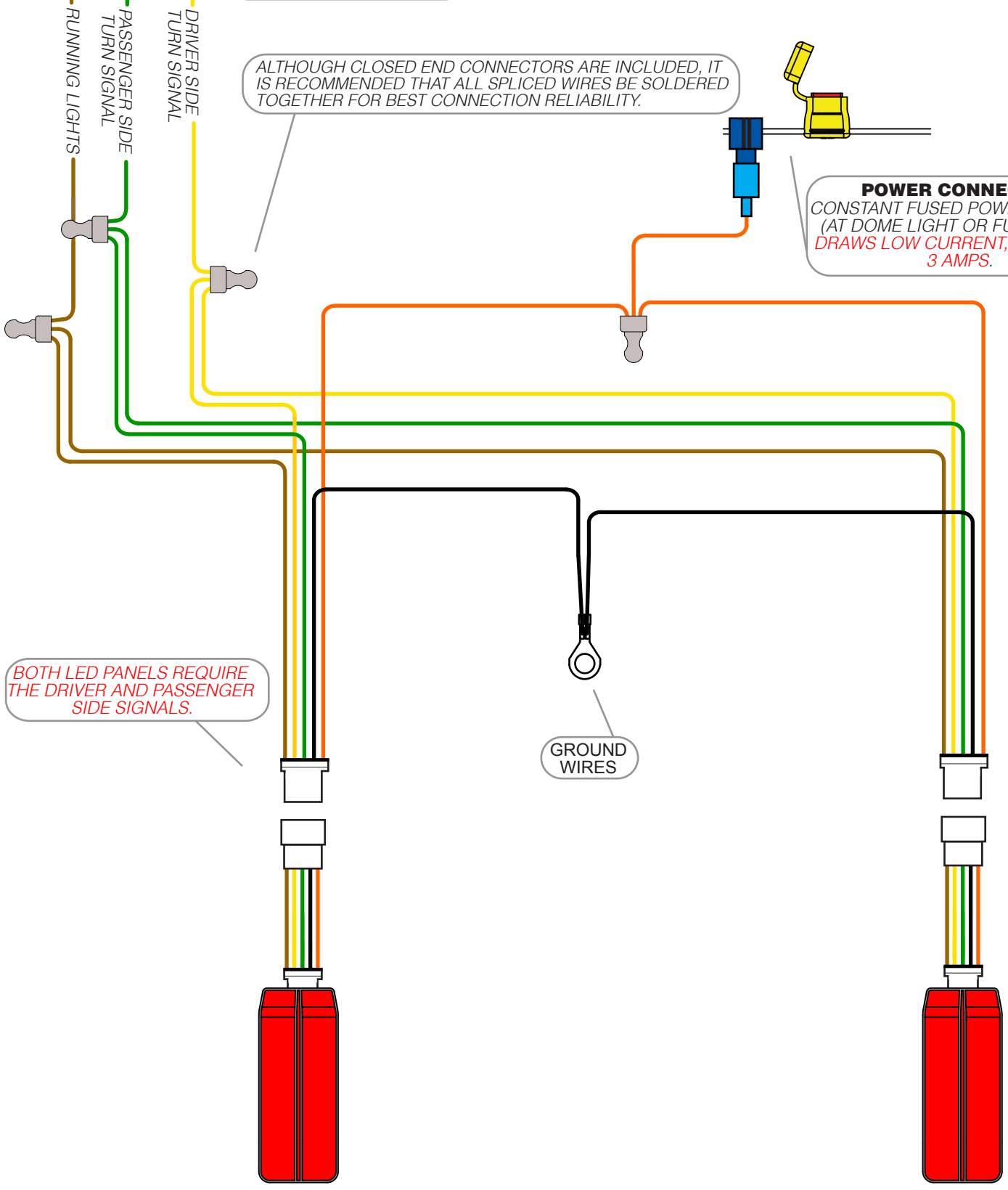

BOTH LED PANELS REQUIRE THE DRIVER AND PASSENGER SIDE SIGNALS.

GROUND WIRES

DRIVER SIDE LED PANEL

PASSENGER SIDE LED PANEL

PN 1101281

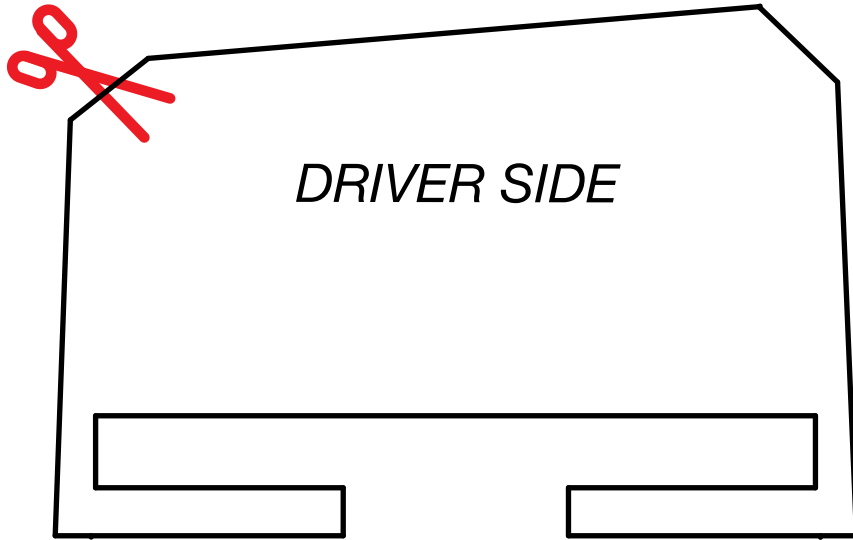

Cut out the templates and position them on the bottom side of the taillight housing.

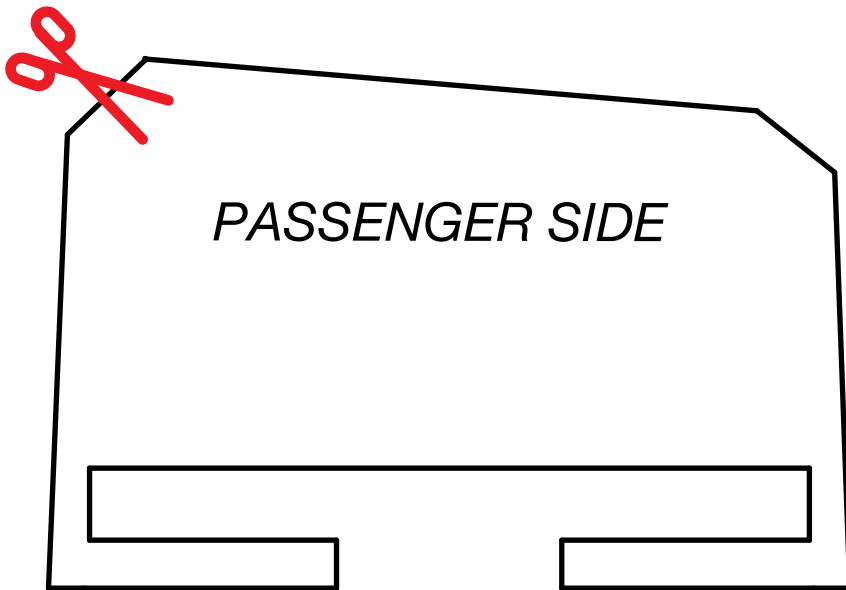

DIGITAILS
DIGITAL TAILLIGHTS