

Detroit Speed  
C10 SpeedMAX Front Suspension  
1967-87 GM C10 Truck

P/N: 032080DS, 032080-SDS, 032080-DDS, 032082DS, 032082-SDS, 032082-DDS,  
032083DS, 032083-SDS & 032083-DDS

The Detroit Speed C10 SpeedMAX front suspension is designed to improve the handling and performance of your 1967-87 GM C10 Truck while lowering the front ride height. This 100% bolt-on front suspension system can be installed at the stock location or one inch forward for improved wheel/fender alignment. Body panels and the engine do not need to be removed for installation. This system features "Detroit Tuned" power rack and pinion steering, forged in the USA DSE aluminum uprights featuring 5 x 5" or 5 x 4-3/4" dual bolt pattern modern hub pack wheel bearings. DSE "Detroit Tuned" aluminum body coilover shocks/springs allow spring rate tuning and ride height adjustment. This system includes tubular upper and lower control arms with Delrin bushings and stainless-steel cross shafts featuring caster tuner bushings.



PN: 032082DS Shown - 1973-87 C10

***IMPORTANT:***

A qualified technician should perform all work. Please read the complete set of instructions and fully understand all the steps involved before beginning the project. Always make sure to wear the appropriate safety equipment for the job and properly support the truck. If you have any questions before, during, or after the installation, feel free to contact Detroit Speed by phone at (704) 662-3272 or by email at [sales@detroitsspeed.com](mailto:sales@detroitsspeed.com).

NOTE: There is an installation video available through the DSE website and on YouTube shown here:  
[https://www.detroitsspeed.com/products/suspension\\_and\\_chassis/subframe\\_assemblies/speedmax/](https://www.detroitsspeed.com/products/suspension_and_chassis/subframe_assemblies/speedmax/).

[https://www.youtube.com/watch?v=BJePM\\_k2goQ](https://www.youtube.com/watch?v=BJePM_k2goQ).

Item #	Description	Quantity
1	Cradle Assembly	1
2	Upper Control Arm Mount Bracket, LH and RH	2
3	Coilover Mount, LH and RH	2
4	Power Rack and Pinion Assembly	1
5	Steering Shaft Frame Rail Reinforcement	1
6	Sway Bar Bracket, LH and RH	2
7	1-1/8" OD Sway Bar	1
8	Lower Control Arm Assembly, LH and RH	2
9	Upper Control Arm Assembly, LH and RH	2
10	Upright Assembly, LH and RH	2
11	Engine Mount Bracket, LH and RH	2
12	Coilover Shock	2
13	Coilover Spring	2
14	Instructions	1

Specifications - Detroit Speed C10 SpeedMAX	
Total Suspension Travel	6"
Ride Height*	0.4" ±1.0"
Installed Shock Length**	15.0"
Static Camber	-0.5° ± 0.2°
Static Caster***	+7.0° ± 0.5°
Static Toe	0.0° ± 0.1°
* Measured from bottom of frame rail to center of the hub. When raising the ride height from nominal, the center of the hub may drop below bottom of frame rail. ** Measured from center of shock bolt to center of shock bolt. *** As truck rake increases, caster decreases.	

1973-87 C10 Wheel & Tire Fitment Suggestions					
Diameter (in.)	Width (in.)	Backspacing (in.)	Lug Nut Thread Pitch	Recommended Tire Size	Comments
Stock Inner Fender					
18	9	5.25	1/2"-20	275/45R18	Deep Lug Nuts Required
19				275/40R19	
20				275/35R20	
Modified or No Inner Fender					
18	11	6.50	1/2"-20	295/45R18	Deep Lug Nuts Required
19				295/40R19	
20				305/35R20	

NOTE: Minimum wheel diameter of 17" with an inside wheel diameter of at least 16.250" will be required.  
**Caution:** Some brake applications will not work with 17" wheels. Flush mount valve stems may also be required on wheels with a behind the center valve location.

1967-87 C10 SpeedMAX Front Suspension			
Engine	Mounting	Oil Pans	Steering Coupler
Small Block Chevy	Stock type mounts & brackets	Stock or Aftermarket	DSE PN: 092531DS (1979-87 Only)
Big Block Chevy			DSE PN: 092536DS (1973-78 Only)
LS	Hooker Blackheart LS Swap Engine Mount Brackets PN: 12621HKR Hooker Blackheart Engine Mount Kit PN: VK090150 or VK090151	Holley PN: 302-2, 302-3 or 302-5	DSE PN: 092534DS (1967-72 Only)

**NOTE:** Required parts for the C10 SpeedMAX front suspension include a new steering coupler kit (DSE PN: 092531DS - 1979-87 C10) as well as new front brakes. OE-style GMT800 truck new front brake upgrades are recommended below. Aftermarket front brake systems are also available through Baer and Wilwood for the C10 SpeedMAX.

**OE-style Brake Recommendations:**

Front Caliper, RF Raybestos FRC11713N or AC Delco 18FR2246N  
 Front Caliper, LF Raybestos FRC11714N or AC Delco 18FR2247N  
 Front Brake Pads Raybestos EHT1363H or AC Delco 17D1363CHF1

Brake Hose Raybestos BH38102 (Use on 1967-72 applications)  
 Brake Hose, RF Raybestos BH 38065 (Use on 1973-87 applications)  
 Brake Hose, LF Raybestos BH 38066 (Use on 1973-87 applications)  
 Brake Rotor, 13" Detroit Speed 050403DS

**Baer Brake System Part Numbers:**

4301586 Pro+ 13" rotor (R, B, or S for caliper color)  
 4301587 Pro+ 14" rotor (R, B, or S for caliper color)  
 4301588 Extreme+ 14" rotor (R, B, or S caliper color)

**Wilwood Brake System Part Numbers:**

140-16781 Superlite 6 piston caliper, 13.06" slotted rotor, black powder coat  
 140-16781-D Superlite 6 piston caliper, 13.06" drilled & slotted rotor, black powder coat  
 140-16781-DR Superlite 6 piston caliper, 13.06" drilled & slotted rotor, black powder coat  
 140-16781-R Superlite 6 piston caliper, 13.06" slotted rotor, red powder coat

140-16780 Aerolite 6 piston caliper, 14.25" slotted rotor, black powder coat  
 140-16780-D Aerolite 6 piston caliper, 14.25" drilled & slotted rotor, black powder coat  
 140-16780-DR Aerolite 6 piston caliper, 14.25" drilled & slotted rotor, red powder coat  
 140-16780-R Aerolite 6 piston caliper, 14.25" slotted rotor, red powder coat

## Hardware Kit Checklist – Detroit Speed C10 SpeedMAX Front Suspension

Part Number	Description	Quantity	Check
<b>200083</b>	<b>Crossmember/UCA Mount Bracket Hardware Kit</b>	<b>1</b>	
980040FS	1/2"-20 x 1-1/4" L Hex Head Bolt, Yellow Zinc	6	
980058FS	1/2"-20 x 3" L Hex Head Bolt, Yellow Zinc	4	
960004FS	1/2"-20 Nylock Nut, Yellow Zinc	6	
970037FS	1/2" SAE Flat Washer, Yellow Zinc	12	
950042FS	7/16"-20 x 1-1/4" L Hex Head Bolt, Yellow Zinc	14	
960050FS	7/16"-20 Nylock Nut, Yellow Zinc	14	
970042FS	7/16" SAE Flat Washer, Yellow Zinc	28	
<b>200084</b>	<b>Upper Control Arm Hardware Kit</b>	<b>1</b>	
960004FS	1/2"-20 Nylock Nut, Yellow Zinc	4	
970037FS	1/2" SAE Flat Washer, Yellow Zinc	4	
920009FS	1/8" Thick 1/2" Slot Body Shim	20	
<b>200085</b>	<b>Coilover Hardware Kit</b>	<b>1</b>	
980026FS	1/2"-20 x 2-1/2" L Hex Head Bolt, Yellow Zinc	4	
960004FS	1/2"-20 Nylock Nut, Yellow Zinc	4	
970037FS	1/2" SAE Flat Washer, Yellow Zinc	6	
980127FS	7/16"-20 x 1-1/2" L Hex Head Bolt, Yellow Zinc	4	
950042FS	7/16"-20 x 1-1/4" L Hex Head Bolt, Yellow Zinc	2	
960050FS	7/16"-20 Nylock Nut, Yellow Zinc	6	
970042FS	7/16" SAE Flat Washer, Yellow Zinc	12	
<b>200086</b>	<b>Steering Rack Hardware Kit</b>	<b>1</b>	
950137FS	M16-2 x 100 Flanged Hex Head Bolt, Clear Zinc	2	
960110FS	M14-1.5 Jam Nut, Clear Zinc	2	
980027FS	3/8"-16 x 1" L Hex Head Bolt, Yellow Zinc	2	
960053FS	3/8"-16 Nylock Nut, Yellow Zinc	2	
970023FS	3/8" SAE Flat Washer, Yellow Zinc	4	
<b>200088</b>	<b>Sway Bar Hardware Kit</b>	<b>1</b>	
980132FS	7/16"-20 x 2-1/2" L Hex Head Bolt, Yellow Zinc	2	
950042FS	7/16"-20 x 1-1/4" L Hex Head Bolt, Yellow Zinc	2	
960050FS	7/16"-20 Nylock Nut, Yellow Zinc	4	
970042FS	7/16" SAE Flat Washer, Yellow Zinc	8	
950027FS	3/8"-16 x 3/4" L Hex Head Bolt, Yellow Zinc	4	
970023FS	3/8" SAE Flat Washer, Yellow Zinc	4	
960081FS	M12-1.75 Prevailing Torque Flanged Nut, Clear Nut	4	
<b>200089</b>	<b>SBC Engine Mount Hardware Kit</b>	<b>1</b>	
980053FS	3/8"-16 x 1-1/4" L Hex Head Bolt, Yellow Zinc	4	
960066FS	3/8"-16 Prevailing Torque Flanged Nut, Yellow Zinc	4	
970023FS	3/8" SAE Flat Washer, Yellow Zinc	4	
<b>9303298</b>	<b>Lower Control Arm Hardware Kit</b>	<b>1</b>	
980034FS	9/16"-18 x 3-3/4" L Hex Head Bolt, Yellow Zinc	4	
960022FS	9/16"-18 Nylock Nut, Yellow Zinc	4	
970020FS	9/16" SAE Flat Washer, Yellow Zinc	8	

<b>Fastener Torque Specifications – Detroit Speed C10 SpeedMAX Front Suspension</b>			
<b>Application</b>	<b>Thread Size</b>	<b>Torque (ft-lb)</b>	<b>Threads</b>
Crossmember Mounting Bolts	1/2"-20	85	Anti-Seize
Upper Control Arm Mount Bracket/ Engine Mount Bracket Bolts	7/16"-20	58	Anti-Seize
Lower Engine Mount Bracket Bolts	3/8"-16	28	Anti-Seize
Upper Control Arm Cross-shaft Mounting Nuts	1/2"-20	75	Anti-Seize
Coilover Mount Bracket Bolts	7/16"-20	58	Anti-Seize
Rack and Pinion Mounting Bolts	M16-2.0	180	Blue Loctite 242
Lower Control Arm Mounting Bolts	9/16"-18	95	Anti-Seize
Sway Bar Frame Mount Bracket Bolts	7/16"-20	45	Anti-Seize
Sway Bar Bushing Bracket Bolts	3/8"-16	28	Blue Loctite 242
Sway Bar Shaft Clamp Screw	1/4"-28	14	Blue Loctite 242
Sway Bar Link Nuts	M12-1.75	53	Anti-Seize
Coilover Shock Mounting Bolts	1/2"-20	60	Anti-Seize
Upper Control Arm Ball Joint Stud Nut*	1/2"-20	60	None
Lower Control Arm Ball Joint Stud Nut*	5/8"-18	100	None
Outer Tie Rod End Stud Nut*	M12-1.25	44	None
Outer Tie Rod End Jam Nut	M14-2.0	55	None
Wheel Hub Bearing/Steer Arm Mounting Bolts	M14-1.5	133	Red Loctite 262
Front Brake Caliper Mounting Bracket Bolts	M14-2.0	129	Red Loctite 262
Wheel Stud Nuts	1/2"-20	100	None
* Always tighten slotted nuts to line up with the cotter pin hole when applicable.			

**Installation:**

1. Raise the truck on jack stands so that the frame is level with the ground. Remove the front wheels from the truck (Figure 1).



**Figure 1 – Remove Wheels**

2. Remove the front sway bar from the lower control arms if equipped by removing the factory 3/8" hardware (Figure 2 on the next page). Remove the sway bar from the frame.



Figure 2 - Remove Sway Bar

3. Place a floor jack under the lower control arm and remove the shocks from the truck (Figure 3). Remove the floor jack so the upper control arm sits on the jounce bumper on the frame. Remove the upper shock mount stud from the frame rail.



Figure 3 - Remove Shocks

4. Remove the brake hose from the brake caliper on both sides of the truck. **NOTE:** Push a piece of rubber hose in the brake hose fitting to keep it from leaking (Figure 4).

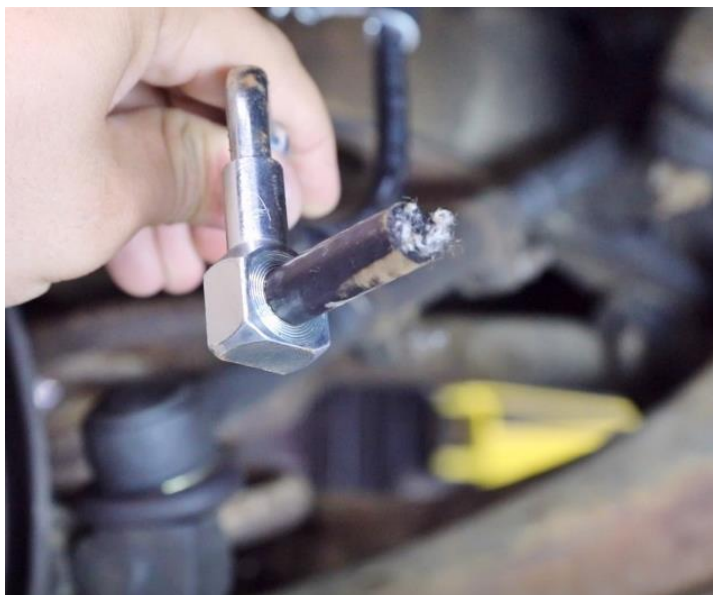

Figure 4 - Remove Brake Hose

5. Remove the brake hose bracket from the upper control arm so it is free from the suspension on both sides of the truck. Move the brake hoses away from the suspension. (Figure 5).



Figure 5 - Remove Brake Hose From Suspension

6. Remove the fasteners holding the idler arm to the outside of the frame rail. Push the idler arm away from the frame rail (Figure 6).

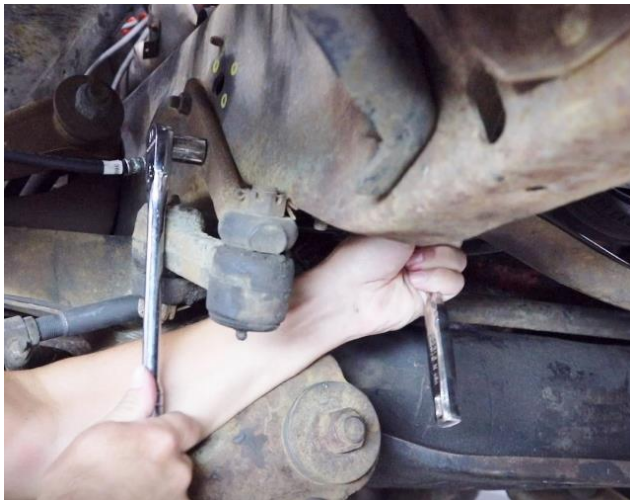

Figure 6 - Remove Idler Arm

7. Remove the pitman arm nut from the steering box. Use a pitman arm puller to remove the pitman arm from the steering box (Figure 7).



Figure 7 - Remove Pitman Arm

8. From the front side of the factory cradle, remove the engine mount hardware and remove the bolts from the back side of the cradle on both sides of the truck (Figure 8).



**Figure 8 - Remove Engine Mount Hardware**

9. Use an engine hoist to lift the engine up out of the engine mounts. Place a jack stand underneath the truck towards the back of the engine. Lower the engine back down so the oil pan rests on a block of wood placed on the jack stand so that the engine mounts are free from the engine stands on the cradle (Figure 9).



**Figure 9 - Raise Engine**

10. Remove the two bolts on top of the frame rail holding the engine stands in place on both sides of the frame rail (Figure 10).



**Figure 10 - Remove Upper Engine Bracket Hardware**



11. Remove the two bolts on the bottom side of the cradle, inboard of the upper spring mount holding the engine stands in place. Remove these bolts from both sides of the frame (Fig. 11).

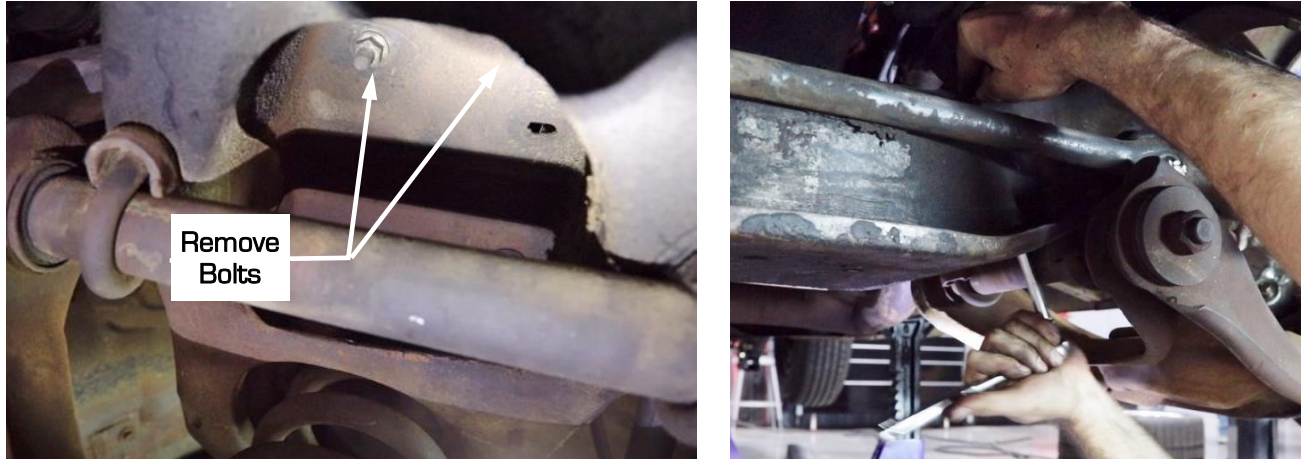

Figure 11 – Remove Lower Engine Bracket Hardware

12. Drop the engine mount brackets down and out of the cradle (Figure 12). If the engine mounts are old and worn out DSE recommends replacing them.

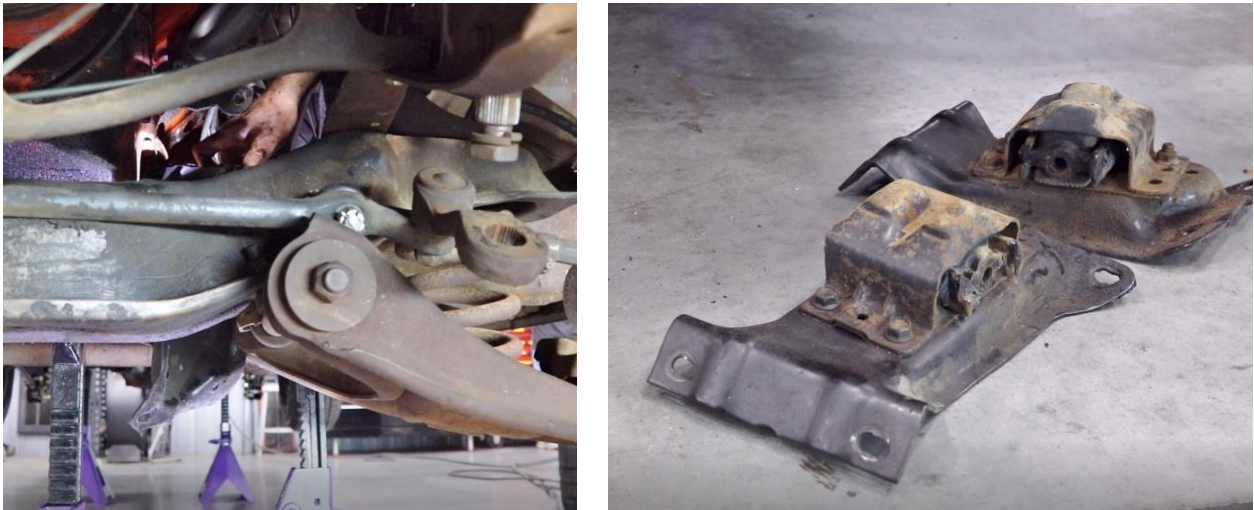

Figure 12 – Remove Engine Mount Brackets

13. Next, remove the bolt holding the fuel line clamp to the cradle (Figure 13).



Figure 13 – Remove Fuel Line Clamp

14. Locate and remove the three bolts on each side of the cradle holding it to the frame rails. Use a wrench on the top side of the cradle to hold the flange nuts and remove the bolts (Figure 14).



**Figure 14 - Remove Cradle Hardware**

15. Locate the two lower bolts on the inside of the frame rail that hold the upper control arm bracket to the frame. Remove these two bolts from the welded nut inserts on the upper control arm brackets on both sides of the truck (Figure 15).

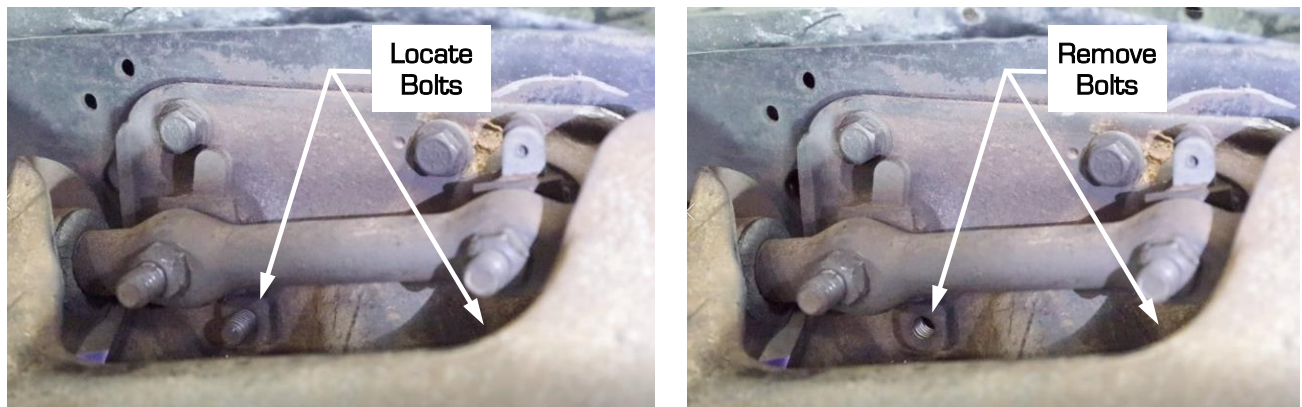

**Figure 15 - Remove Lower Upper Control Arm Bracket Bolts**

16. Place a floor jack underneath the cradle and lift up the cradle slightly so there is no tension on the frame rails (Figure 16).



**Figure 16 - Prepare to Remove the Cradle**

17. Remove the remaining two bolts on each side of the frame rail that are left in the upper control arm mount brackets (Figure 17).



Figure 17 – Remove Upper Control Arm Bracket Bolts

18. With all the hardware removed, slowly lower the floor jack down. Make sure that nothing is still attached to prevent the cradle from being removed from the truck. Lower the floor jack and roll the cradle out from underneath the truck (Figure 18).



Figure 18 – Remove the Factory Cradle

19. Loosen the pinch bolt from the rag joint. Pry the rag joint off the steering gear (Figure 19).



Figure 19 – Remove the Rag Joint

20. Remove the pressure and return power steering lines from the steering gear by loosening the fittings with a wrench (Figure 20). Plug the lines and steering gear to keep them from leaking.



Figure 20 - Remove Power Steering Lines

21. Loosen the steering gear bolts from the inside of the frame rail (Figure 21).



Figure 21 - Loosen Steering Gear Bolts

22. Remove the bolts from the steering gear while holding the steering gear to keep it from falling to the ground (Figure 22). **CAUTION:** You may want someone to help you remove the heavy steering gear.



Figure 22 - Remove Steering Gear

23. Remove the hardware holding the steering coupler to the steering column. Remove the steering coupler from the truck by pulling it off the end of the steering column (Figure 23). **NOTE:** You may need to use a hammer to tap it off the end of the column.

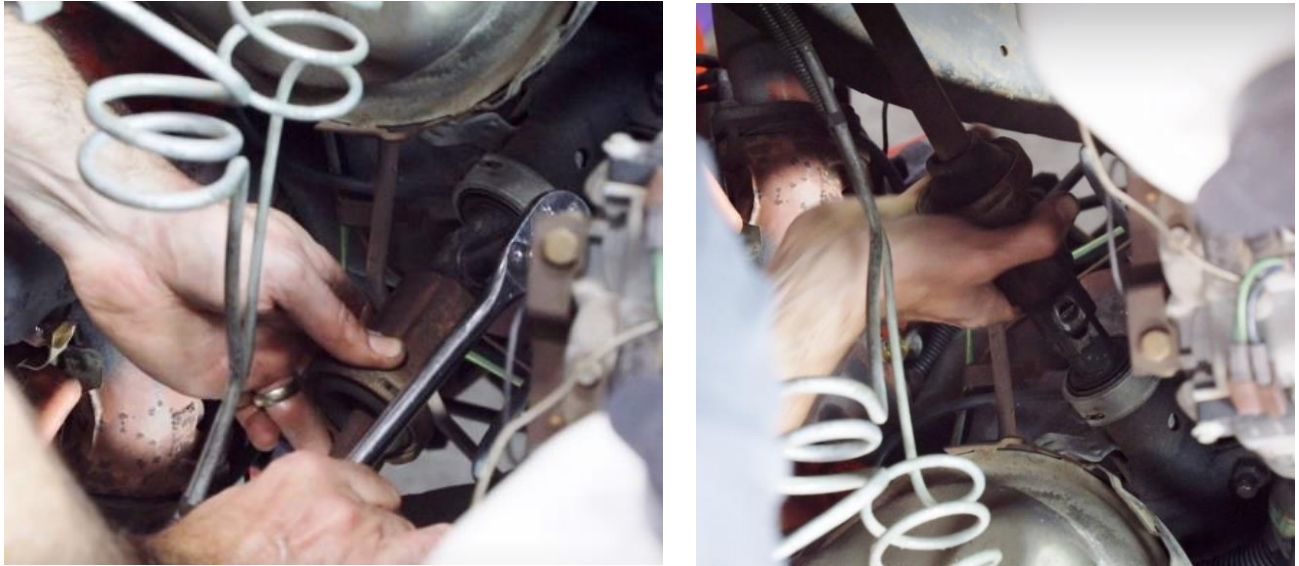

Figure 23 - Remove Steering Coupler

24. Next, you will need to notch the top frame rail to allow the steering shaft to be connected to the rack and pinion. Locate the provided steering shaft frame rail reinforcement. This will be used as a template to notch the top frame rail.

25. Install the frame rail reinforcement to the top of the frame rail using pre-existing holes to locate the reinforcement. Use the provided 3/8"-16 x 1" L hex head bolts, Nylock nuts and washers and tighten the reinforcement to the frame rail.

26. Use a scribe to trace the oval shape in the reinforcement bracket to the top side of the frame rail. Remove the reinforcement and cut this shape into the frame rail. Grind the edges smooth for a clean finish (Figure 24). **NOTE:** The steering shaft reinforcement bracket will be installed later when you install the steering shaft.



Figure 24 - Notch Frame Rail

27. Place three of the provided 1/2"-20 x 1-1/4" L hex head bolts and washers through the bottom side of each of the frame rails where the factory cradle was installed (Figure 25 on the next page). Use anti-seize on the threads of the bolts.



Figure 25 - Locate Bolts in Frame Rails

28. Use a floor jack to position the DSE cradle assembly under the truck. Locate the DSE cradle to the frame rails so the 1/2" bolts in the frame rails pass through the top side of the cradle.

**NOTE:** There are two sets of mounting holes in the cradle. Use the forward set of holes to maintain the stock wheel base. This is recommended for 1973-87 applications. Use the rearward set of holes to move the front axle forward by 1". This is recommended for 1967-72 applications (Figure 26).

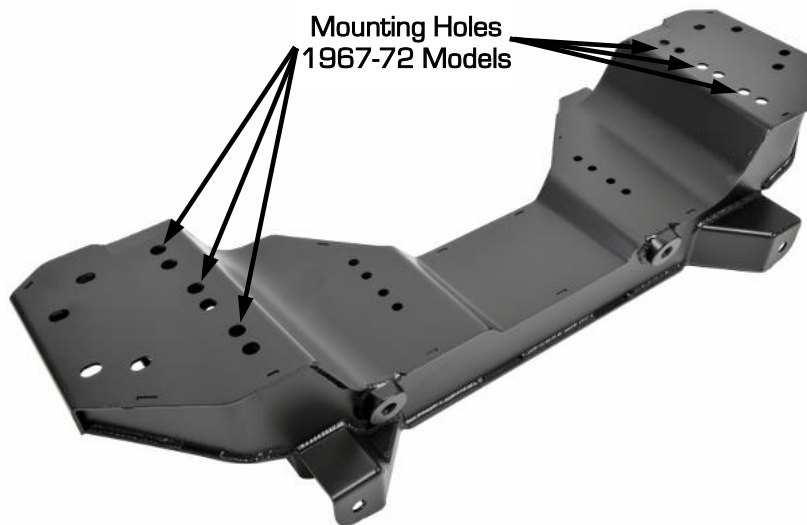

Figure 26 - DSE Cradle Assembly

29. Install the provided Nylock nuts and washers to position the cradle to the frame. Use anti-seize on the threads of the bolts. Lightly snug the hardware but do not fully tighten yet (Figure 27).

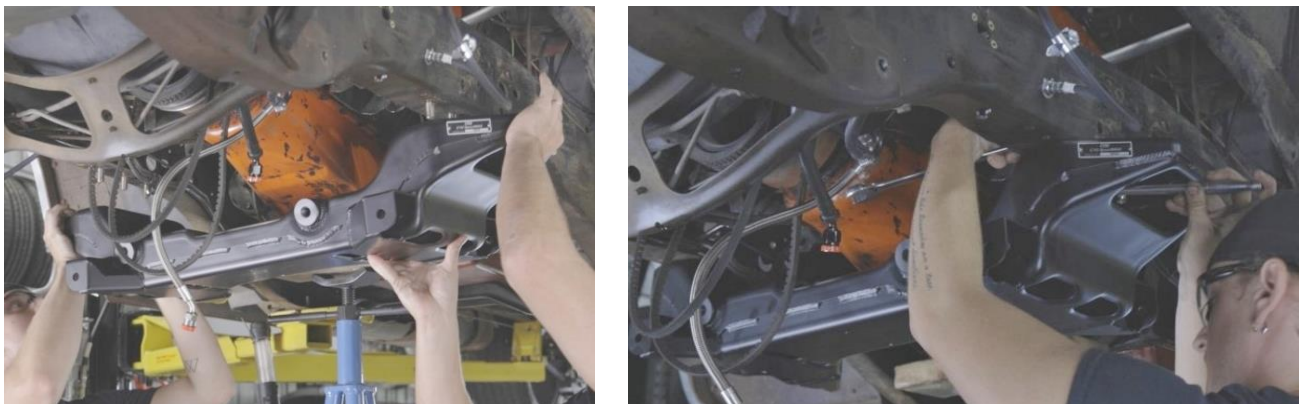

Figure 27 - Locate DSE Cradle to Frame Rails

30. Next, locate the coated cast steel upper coilover mounts (Figure 28). There is a "L" and "R" cast into these parts to determine the left and right hand side.



Figure 28 - Upper Coilover Mounts

31. Place the upper coilover mounts on the outboard side of the frame rails so they sit on the top of the DSE cradle on both sides of the truck. The "L" and "R" will face the rear of the truck when installed correctly.

32. Place two of the 7/16"-20 x 1-1/2" L hex head bolts and washers through the upper coilover mounts and into the cradle on both sides of the truck. If you are using the factory inner fenders, they will need to be modified to allow for clearance to the upper coilover mounts.

33. Use masking tape on the bottom side of the inner fenders, right above the coilover mounts. Trace the shape of the coilover mounts onto the inner fender, adding clearance for upper shock hardware. Remove the upper coilover mounts and cut your inner fender where they are marked (Figure 29 & 30). **NOTE:** On the driver's side, you may want to add clearance for the upper control arm if you will be at a low ride height.



Figure 29 - Driver's Side Inner Fender



Figure 30 - Passenger's Side Inner Fender

34. Next, locate the left and right hand side upper control arm mount brackets (Figure 31).



Figure 31 - Upper Control Arm Mount Brackets

35. Place two of the provided 1/2"-20 x 3" L hex head bolts through the flat side of the upper control arm mount brackets. The head of the bolt will lock into the hex head hole so the threads of the bolts pass through the weld bushings on the other side of the brackets (Figure 32).



Figure 32 – Install Upper Control Arm Bolts

36. Place the correct side upper control arm mount brackets on top of the cradle assembly outboard of the frame rails. The flat side with the head of the hex bolt will sit against the outboard frame rail and the bottom of the bracket will sit on top of the cradle (Figure 33).

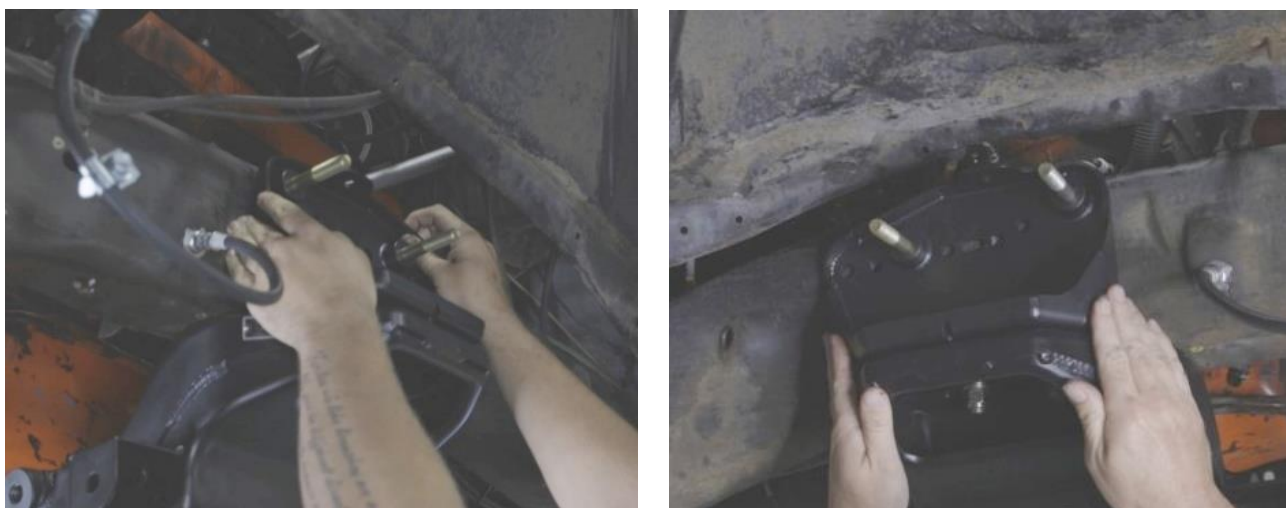

Figure 33 – Locate Upper Control Arm Brackets

**NOTE:** For the 1973-87 truck applications, you can move the upper control arm brackets back 1" in the rearward set of holes in the cradle. This will allow you to move your engine back 1" as well as give you more oil pan clearance if you are not using a Holley oil pan. You will have to drill out two additional holes on both sides of the frame rails. Use the upper control arm brackets as a template to drill these two holes. You will have a total of four holes to install hardware through each bracket and frame rail.

37. Place two of the provided 7/16"-20 x 1-1/4" L hex head bolts and washers through the row of holes closest to the frame on the upper control arm mount brackets so they pass through the cradle assembly. Use anti-seize on the threads of the bolts. Use the provided 7/16"-20 Nylock nuts and washers to loosely install the brackets to the cradle on both sides of the truck (Figure 34 on the next page). Do not tighten the hardware at this time.





Figure 34 - Loosley Install Upper Control Arm Brackets

38. Place four of the provided 7/16"-20 x 1-1/4" L hex head bolts and washers through the outboard side of the upper control arm brackets on both sides of the truck. There should be four open holes that will allow the bolts to pass through the control arm bracket and frame rail (Figure 35). Do not install the Nylock nuts and washers at this time.



Figure 35 - Install Mounting Hardware

39. Next, locate the left and right hand engine mount brackets. The instructions and video show the 1973-87 applications (Figure 36). The engine mount brackets for the 1967-72 applications are shown in Figure 37.



Figure 36 - 1973-87 C10



Figure 37 - 1967-72 C10

40. The slotted hole on the brackets will be towards the front of the truck when installed against the inside of the frame rail. Position the brackets on the threads of two of the the 7/16"-20 bolts towards the front of the truck that were installed (Figure 38). These are the bolts that were installed through the upper control arm mount brackets and the frame rail. One of the bolts will pass through the slotted holes in the engine mount brackets.



**Figure 38 – Position Engine Mount Brackets**

**NOTE:** If you have moved your upper control arm brackets back 1", you will need to move your engine mount brackets to the rearward set of the holes in the cradle to line up with the upper control arm brackets.

41. Place the provided 7/16"-20 Nylock nuts and washers on all eight bolts on the inside of the frame rail on both sides of the truck (Figure 39). Use anti-seize on the threads of the bolts. Do not tighten the hardware at this time.



**Figure 39 – Install 7/16" Hardware**

42. Install the provided 3/8"-16 x 1-1/4" L hex head bolts and washers through the lower engine mount brackets and into the cradle assembly. Use anti-seize on the threads of the bolts. Place the provided 3/18"-16 prevailing torque flanged nuts and washers on the threads of the bolts. Access the bolts through the windows in the bottom side of the cradle assembly (Figure 40 on the next page). Do not tighten the hardware at this time.



Figure 40 – Install Engine Mount Brackets

43. Next, remove the engine mounts from the factory cradle brackets that were removed in **Step 12**. Install them on the factory engine mount brackets with the factory hardware (Figure 41). **NOTE:** DSE recommends replacing your engine mounts if they are old and worn out.



Figure 41 – Install Engine Mounts

44. Lower the engine down so the engine mounts sit and line up with the engine mount cradle brackets. Install the original hardware that was removed in **Step 8** through the engine mounts and the engine mount brackets (Figure 42).



Figure 42 – Install Engine to Brackets

45. Next, square up the cradle assembly to the frame rails. Place two of the provided 7/16"-20 x 1-1/4" L hex head bolts and washers through the outboard row of holes in the upper control arm brackets on both sides of the truck (Figure 43). Do not install the 7/16" Nylock nuts and washers at this time.



Figure 43 - Install Hardware

46. Now that all the hardware has been located in the cradle assembly to the frame, you can tighten and torque all the hardware except for the hardware installed in the previous step (Figure 44). Torque the 1/2"-20 hardware to 85 lb-ft. Torque the 7/16"-20 hardware to 58 lb-ft. Torque the 3/8"-16 hardware to 28 lb-ft.



Figure 44 - Torque Cradle Hardware

47. Next, locate the upper control arms. There is not a left and right hand side upper control arm as they can be installed on either side of the truck. Place the cross-shafts on the control arms onto the 1/2"-20 x 3" L bolts that have been installed into the hex head bolt holes in the upper control arm mount brackets from **Step 35** on both sides of the truck (Figure 45).



Figure 45 - Install Upper Control Arms

48. Place the provided 1/2"-20 Nylock nuts and 1/2" washers onto the threads of the upper control arm bolts on both sides of the truck. Use anti-seize on the threads of the bolts. If you have installed the cradle assembly in the stock location to maintain the stock wheelbase, install four of the provided 1-1/8 x 1/8 thick body shims on each of the upper control arm bolts. If you have installed the cradle assembly to move the front axle forward, install five of the provided 1-1/8 x 1/8 thick body shims on each of the upper control arm bolts (Figure 46).



Figure 46 – Install Camber Shims

49. Tighten the upper control arms to the brackets keeping the shims in place. Torque the 1/2"-20 upper control arm cross-shaft mounting nuts to 75 lb-ft. (Figure 47).



Figure 47 – Torque Upper Control Arms

50. Remove the 7/16"-20 x 1-1/2" L hex head bolts and washers that were placed in the outside row of the upper control arm brackets from **Step 45** on both sides of the truck.

51. Place the upper coilover mount on the outboard side of the frame rail so it sits on the top of the upper control arm bracket on both sides of the truck (Figure 48). The “L” and “R” will face the rear of the truck when installed correctly.



Figure 48 - Position Upper Coilover Mount

52. Line up the top inboard hole on the coilover mounts with the hole on the top flange of the upper control arm brackets on both sides of the truck. The bottom two holes will line up with the outboard set of holes on the upper control arm brackets. **NOTE:** The coilover mounts will sit outboard of the upper control arm cross shafts (Figure 49).



Figure 49 - Modify Inner Fender

53. Place two of the 7/16"-20 x 1-1/2" L hex head bolts and washers that were removed in Step 46, through the bottom of the coilover mounts, through the upper control arm brackets, and through the cradle assembly. Repeat this step on the opposite side of the truck (Figure 50).



Figure 50 - Install Upper Coilover Mount

54. Install one of the provided 7/16"-20 x 1-1/4" L hex head bolts and washers through the top inboard hole of the coilover mounts and through the top flange of the upper control arm brackets on both sides of the truck.

55. Use anti-seize on the threads of the bolts and install the provided 7/16"-20 Nylock nuts and washers on all six bolts and tighten. Torque the 7/16" hardware to 58 lb-ft. (Figure 51).



Figure 51 - Torque Upper Coilover Mount

56. Next, locate the sway bar bracket assemblies and the sway bar frame mount brackets (Fig. 52).



Figure 52 - Sway Bar & Frame Mount Brackets

57. These will need to be assembled by placing the frame mount tabs inside the sway bar brackets. The holes in the frame mounts will line up with the slotted holes in the sway bar brackets. Install the provided 7/16"-20 x 2-1/2" L hex head bolts and washers through the slotted hole in the sway bar brackets to hold the frame mounts in place (Figure 53).



Figure 53 - Assemble Sway Bar Bracket

58. The open hole on the sway bar bracket will be mounted to the front lower control arm bolt. Identify which sway bar bracket assembly will be for the left and right hand side of the truck (Figure 52 above). The sway bar brackets will offset to the outboard side of the truck when installed.

59. Install the sway bar bracket assembly to the front lower control arm mount using the provided  $9/16$ "-18 x 3-3/4" L hex head bolt and washer. Install the provided  $9/16$ "-18 Nylock nut and washer on the threads of the bolt. Tighten the hardware so the sway bar bracket assembly can be moved by hand (Figure 54). Repeat this process for the opposite side of the truck.



Figure 54 – Locate Sway Bar Bracket

60. Position the sway bar bracket assembly so it is square to the bottom of the frame rail. Use a right angle scribe to locate the hole on the frame mount to the frame rail (Figure 55). Remove the sway bar bracket by removing the front lower control arm bolt. Repeat this process for both sides of the truck.



Figure 55 – Scribe Sway Bar Bracket Mounting Hole

61. Center punch both scribed hole locations on the frame rail. Drill through both hole locations in the frame rail to a final drill size of  $15/32$ " (Fig. 56). Repeat this process for both sides of the truck. **NOTE:** It is recommended that pilot holes be drilled first before drilling the  $15/32$ " holes.



Figure 56 – Drill Sway Bar Bracket Mounting Hole



62. Next, you will need to notch the top frame rail to allow the steering shaft to be connected to the rack and pinion. Locate the provided steering shaft frame rail reinforcement. This will be used as a template to notch the top frame rail.

63. Install the frame rail reinforcement to the top of the frame rail using pre-existing holes to locate the reinforcement. Use the provided 3/8"-16 x 1" L bolts, Nylock nuts and washers and tighten the reinforcement to the frame rail.

64. Scribe the oval shape on the reinforcement onto the top of the frame rail. Remove the reinforcement from the frame rail. Notch the portion of the frame rail that is located inside the oval shape (Figure 57).



Figure 57 - Notch Frame Rail

65. Re-install the frame rail reinforcement onto the top of the frame rail using the provided 3/8"-16 hardware using anti-seize on the threads of the bolts (Figure 58). Tighten the hardware and torque to 30 lb-ft.



Figure 58 - Install Reinforcement

66. Next, install the provided M16-1.5 and M18-1.5 fittings into the ports in the steering rack (Figure 59). Tighten them using a 19mm wrench however make sure you do not overtighten the fittings.



Figure 59 - Install Rack Fittings

67. Next, install the provided outer tie rods onto the rack and pinion. Thread the provided M14-1.5 jam nuts onto both ends of the inner tie rods on the rack and pinion using anti-seize on the threads. Install the outer tie rods onto the inner tie rods up to the jam nuts (Figure 60).



**Figure 60 - Install Outer Tie Rods**

68. Before the rack and pinion is installed, you can verify the rack is centered on the bench before it is installed. Turn the rack all the way to one side and mark the housing where the pre-marked line on the input shaft lands. Turn the rack all the way in the other direction and count the turns in the opposite direction. Mark the housing where the pre-marked line on the input shaft lands. Turn the rack back in the opposite direction 1/2 the number of turns. The pre-marked line on the input shaft and the rack housing should line up and fall in between your two marks on the housing (Figure 61).



**Figure 61 - Center the Rack & Pinion**

69. Position the rack and pinion to the front side of the cradle assembly. Install the provided M16-2.0 x 100mm flanged head hex bolts into the threaded steering rack mounts in the cradle. Use medium strength blue Loctite 242 on the threads of the bolts and torque them to 180 lb-ft. (Figure 62).



**Figure 62 - Install Rack and Pinion**

70. Next, remove the frame mounts from the sway bar brackets by removing the 7/16"-20 hex head bolts that were assembled in **Step 57**. Install the frame mount brackets to the frame rail using the holes that were drilled in **Step 61**. Use the provided 7/16"-20 x 1-1/4" L hex head bolts, Nylock nuts and washers to bolt the frame mounts to the frame rails on both sides of the truck. Use anti-seize on the threads of the bolts (Figure 63). Make sure the mounts are square to the frame rails and torque the hardware to 58 lb-ft.



Figure 63 - Install Sway Bar Bracket

71. Install the provided sway bar frame mount crush sleeves in between the tabs of the frame mount so the holes line up on both sides of the truck (Figure 64). **NOTE:** You may need to spread the tabs on the frame mount brackets to install the crush sleeves.



Figure 64 - Install Sway Bar Mount Crush Sleeve

72. Re-install the 7/16"-20 x 2-1/2" L bolts with washers through the sway bar brackets, frame mounts and the crush sleeves on both sides of the truck. Make sure the sway bar frame mount tabs slide in between the sway bar brackets (Figure 65).

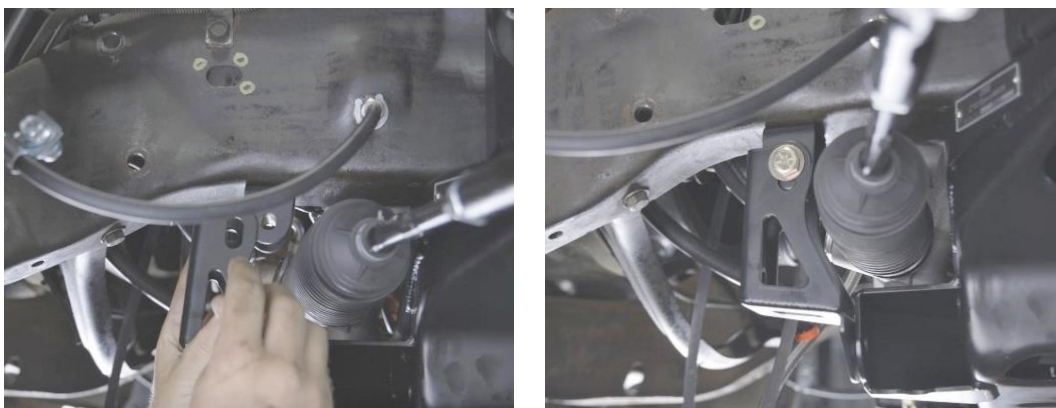

Figure 65 - Install Sway Bar Bracket

73. Install the 7/16"-20 Nylock nuts and washers onto the threads of the bolts on both sides of the truck. Use anti-seize on the threads of the bolts. Do not tighten at this time (Figure 66).



Figure 66 – Install Sway Bar Bracket Hardware

74. Next, identify the left and right hand lower control arm. The sway bar end link bracket on the lower control arms will be towards the front of the truck when installed (Figure 67).

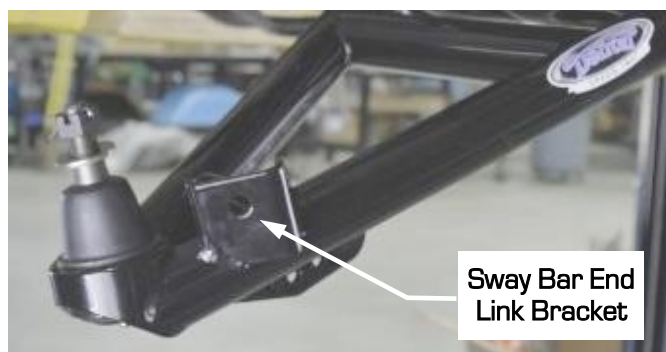

Figure 67 – Lower Control Arm

75. With the lower control arm positioned to the mounts in the cradle assembly, install the provided 9/16"-18 x 3-3/4" L hex head bolt and washer through the sway bar bracket and the front lower control arm mount (Figure 68).



Figure 68 – Install Front Lower Control Arm Hardware

76. Install the other 9/16"-18 x 3-3/4"L hex head bolt and washer through the rearward lower control arm mount so the bolt is pointing towards the front of the truck. Install the provided 9/16"-18 Nylock nuts and washers onto the threads of the bolts. Use anti-seize on the threads of the bolts and tighten (Figure 69).



Figure 69 - Tighten Lower Control Arm

77. Torque the 7/16"-20 sway bar bracket bolts to 45 lb-ft. Torque the 9/16"-18 hardware to 95 lb-ft. (Figure 70). Repeat this process for the other lower control arm on the opposite side of the truck.

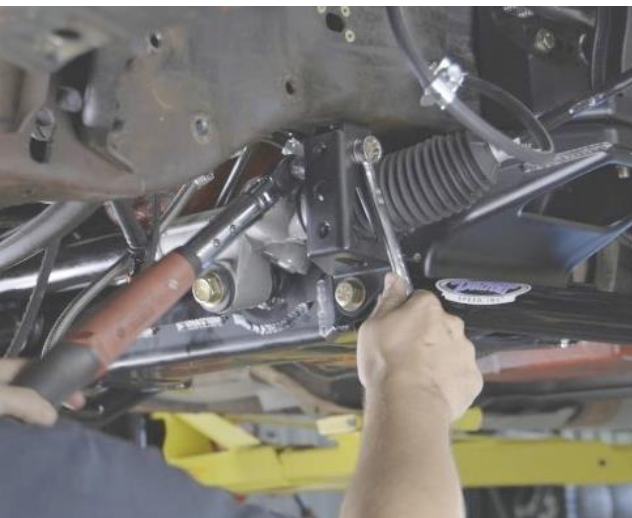

Figure 70 - Torque Lower Control Arm

78. Next, install the sway bar to the sway bar mounting brackets. Use the provided Super Grease to lubricate the inside of the polyurethane bushings (Figure 71).



Figure 71 - Lubricate Bushings

79. Spread the polyurethane bushings so they fit around the sway bar (Figure 72). Locate the bushings as close to the bends on the sway bar as possible.

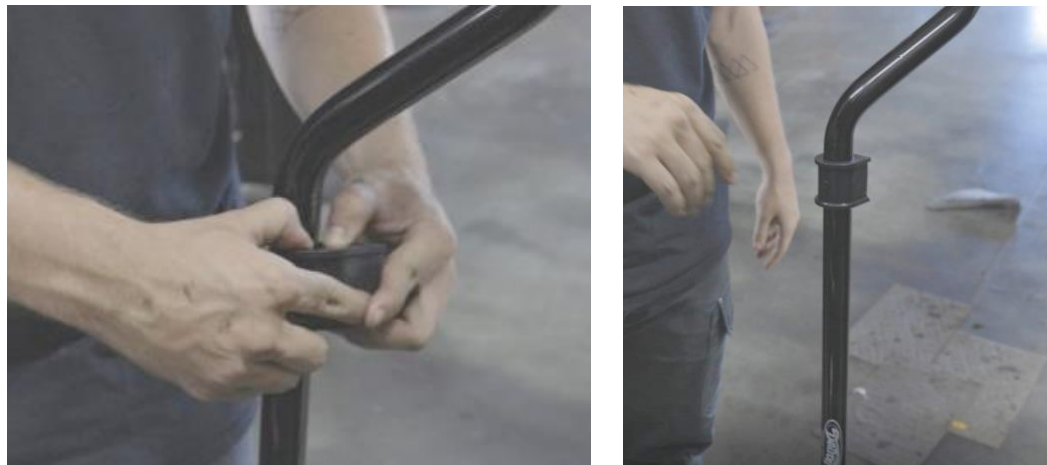

Figure 72 - Install Bushings

80. Place the sway bar bushing brackets over the bushings on the sway bar. Position the sway bar to the mounting brackets on the cradle assembly (Figure 73).



Figure 73 - Locate Sway Bar

81. Install the provided 3/8"-16 x 3/4" L hex head bolts and washers through the sway bar bushing brackets. Use blue Loctite 242 on the threads of the bolts and install them into the weld nuts on the sway bar brackets (Figure 74). Torque the 3/8"-16 hardware to 28 lb.-ft.

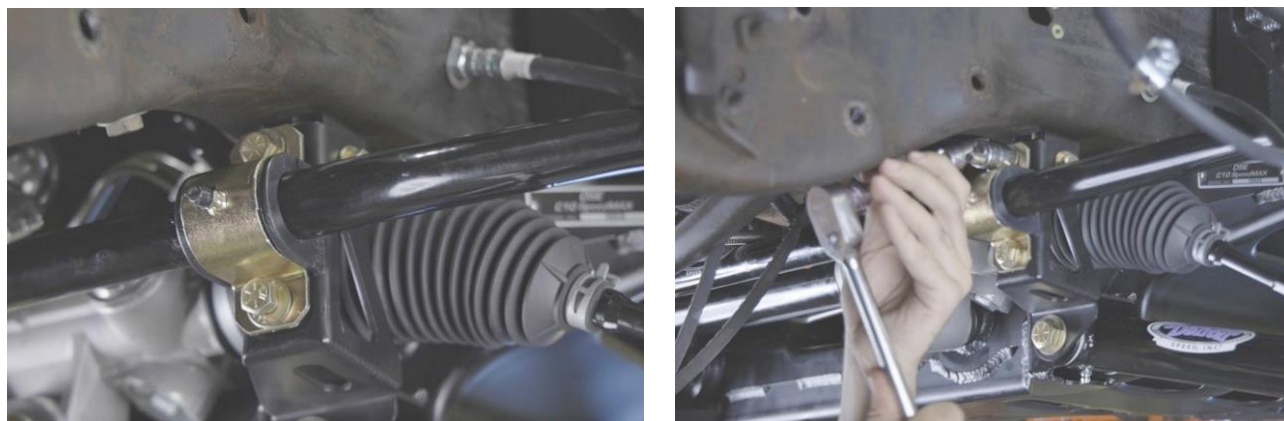

Figure 74 - Install Sway Bar

82. Next, it will be necessary to assemble each coilover shock and spring before installing them into the truck. For the non-adjustable shocks, please use **Steps 83 - 85** to assemble each coilover shock. For the adjustable shocks, please use **Steps 86 & 87** to assemble each coilover shock.

83. Remove the white plastic from the spanner nut and loosely install the provided bolt into the spanner nut (Figure 75). Install the spanner nut over the top of the shaft side of the shock with the flat surface up and thread the spanner nut all the way to the bottom.



Figure 75 – Spanner Nut

84. Place one of the provided spring bearings (Figure 76) over the shock and onto the spanner nut followed by another spring bearing. Then place the coilover spring over the shock so it rests on the spring bearings

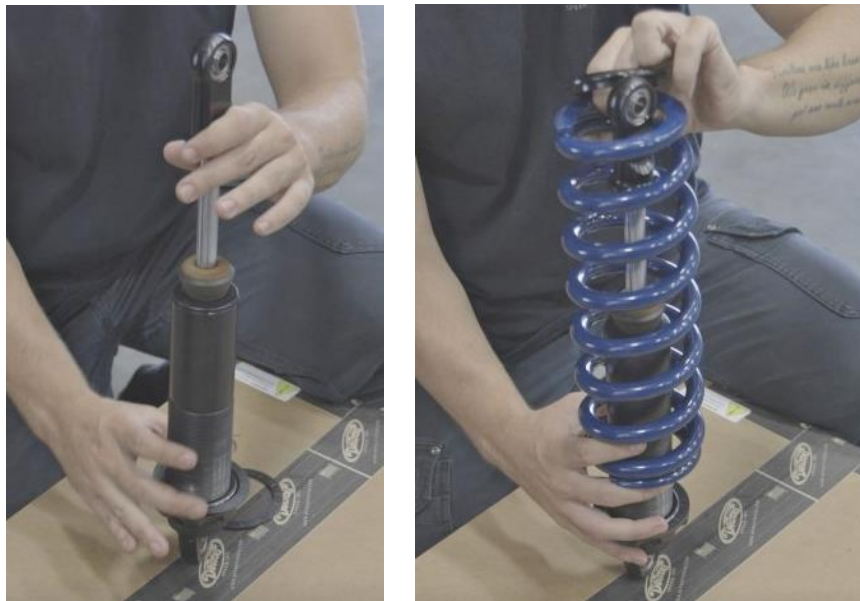

Figure 76 – Coilover Spring & Bearings

85. Place the spring perch over the top of the shock and onto the coilover spring and bearing. Place the retaining ring over the shock and locate the ring into the groove. Press the spring perch up onto the retaining ring so it locks in place (Figure 77). Thread the spanner nut up to the spring, so it stays in place on the shock. Skip to **Step 88**.

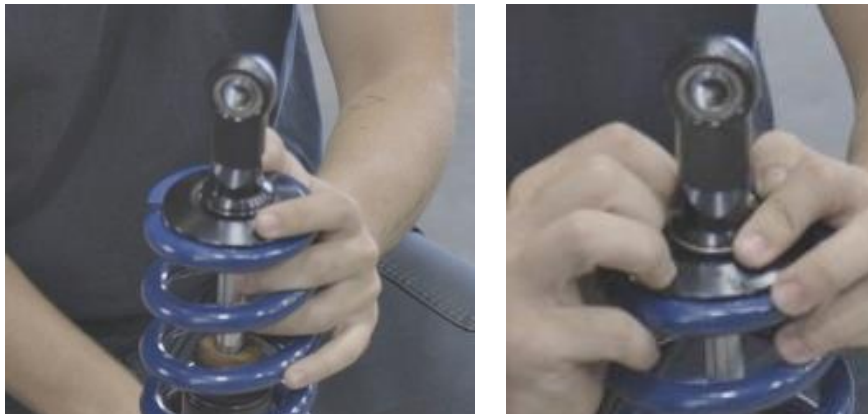

Figure 77 – Spring Perch & Retaining Ring

86. Remove the spring seat from the retaining ring using a rubber hammer. Move it down off the shock mount (Figure 78). Remove the retaining ring from the shock mount and pass the spring seat over the shock mount (Figure 79).



Figure 78 – Remove Upper Spring Seat



Figure 79 – Upper Spring Seat & Retaining Ring

87. Thread the spanner nut all the way to the bottom of the coilover shock and slide the coilover spring over the top of the shock mount. Install the spring seat back over the top of the shock mount and re-install the retaining ring back onto the shock mount. Press the spring seat up onto the retaining ring so it locks in place. Thread the spanner nut up to the spring, so it stays in place on the shock.

88. Place the provided tapered spacers on both sides of the monoball at the body side of the shock (Figure 80).



Figure 80 – Install Tapered Spacers

89. Place the coilover shock and spring assembly up to the cast steel upper shock mount. The shock assembly will pass in between the upper control arm tubes, body side up (Figure 81).



Figure 81 – Position Coilover Shock & Spring Assembly



90. Place the body side of the shock with the tapered spacers into the upper shock mount. Install the provided 1/2"-20 x 2-1/2" L hex head bolt and washer through the upper shock mount, tapered spacers and monoball. Use anti-seize on the threads of the bolt and install the provided 1/2"-20 Nylock nut and washer. Tighten the hardware however do not torque (Figure 82).



**Figure 82 – Install Upper Shock Mounting Hardware**

91. Raise the lower control arm assembly so the lower shock mount in the lower control arm reaches the shaft side mount on the shock. Place the provided 1/2"-20 x 2-1/2" L hex head bolt through the provided 1/2" ID x 3/4" OD x 5/8" L steel bushing (Figure 83).



**Figure 83 – Place Crush Sleeve Over Lower Shock Bolt**

92. Install the 1/2"-20 x 2-1/2" L hex head bolt and steel bushing through the back side of the lower control arm shock mount and monoball. Use anti-seize on the threads of the bolt and install the 1/2"-20 Nylock nut and washer (Figure 84).



**Figure 84 – Install Lower Shock Mounting Hardware**

93. Torque the upper and lower shock mount hardware to 60 lb.-ft. (Figure 85). Repeat Steps 85 through 93 for the opposite side of the truck.

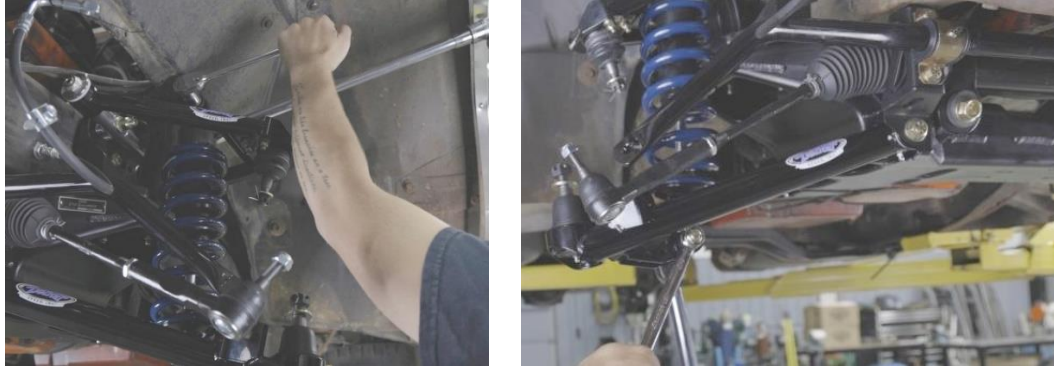

**Figure 85 - Torque Shock Hardware**

94. Next, install the sway bar end links to the lower control arms. Install one end of the end link to the mounting bracket on the lower control arm. The end link will be installed with the stud pointing to the front of the truck.

95. Install the provided M12-1.75 prevailing torque flanged nut on the end link stud using high-strength red Loctite 262 on the threads of the stud. Repeat this process for the opposite side of the truck. Torque the lower flanged nuts to 53 lb.-ft. (Figure 86).

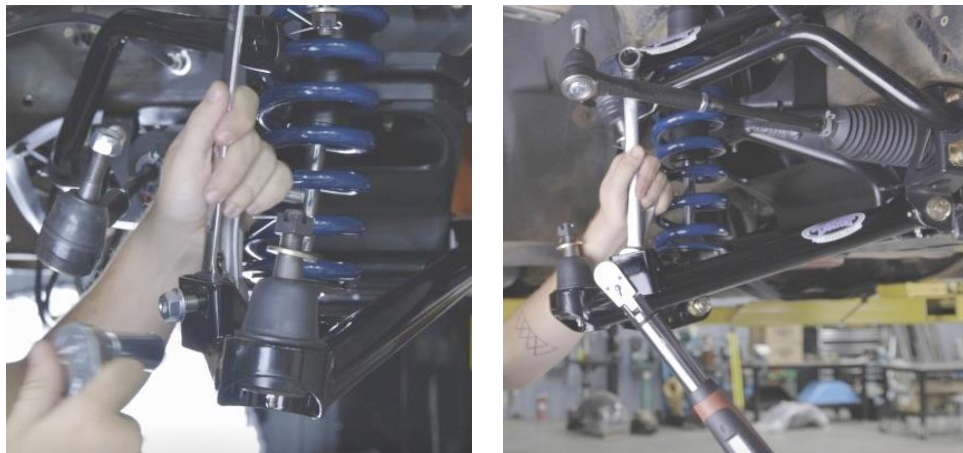

**Figure 86 - Torque Sway Bar End Link**

96. Connect the sway bar to the end link by passing the stud through the mounting hole in the sway bar. The end link stud will be installed with the stud pointing to the rear of the truck (Figure 87).



**Figure 87 - Install Sway Bar End Link**

97. Install the provided M12-1.75 prevailing torque flanged nut on the end link stud using high-strength red Loctite 262 on the threads of the stud. Repeat this process for the opposite side of the truck. Torque the upper flanged nuts to 53 lb.-ft. (Figure 88).



**Figure 88 – Tighten Sway Bar End Link**

98. Center the sway bar in the truck. Separate the split lock collars into two pieces and place medium strength blue Loctite 242 on the threads (Figure 89).



**Figure 89 – Separate Split Lock Collars**

99. Place them around the sway bar so they are tight against the inside of the sway bar bushings on both sides of the truck. Re-assemble using of the bolts and torque to 14 lb.-ft. (Figure 90).

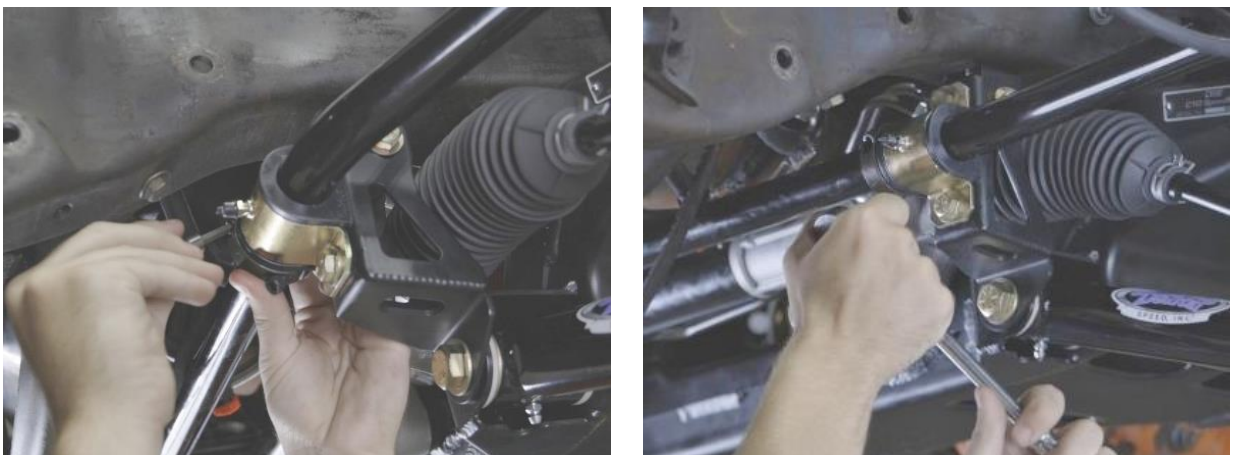

**Figure 90 – Install Split Lock Collars**

100. Next, locate the left- and right-hand side upright corner assemblies (Figure 91). The steering arms will point towards the front of the truck when installed.



Figure 91 - RH Upright Assembly

101. Remove the castle nut, washer, and cotter pin from the upper and lower control arm ball joint studs (Figure 92).

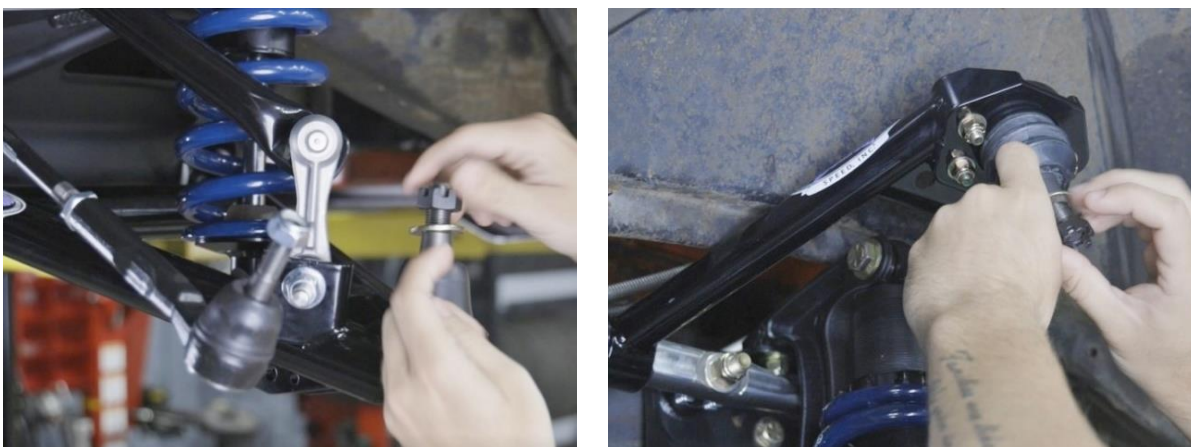

Figure 92 - Remove Ball Joint Hardware

102. Place the upright assembly over the lower ball joint stud on the lower control arm. Install the castle nut and washer onto the ball joint stud to hold the upright in place and tighten (Figure 93). Do not torque at this time. Repeat this process for the opposite side of the truck.

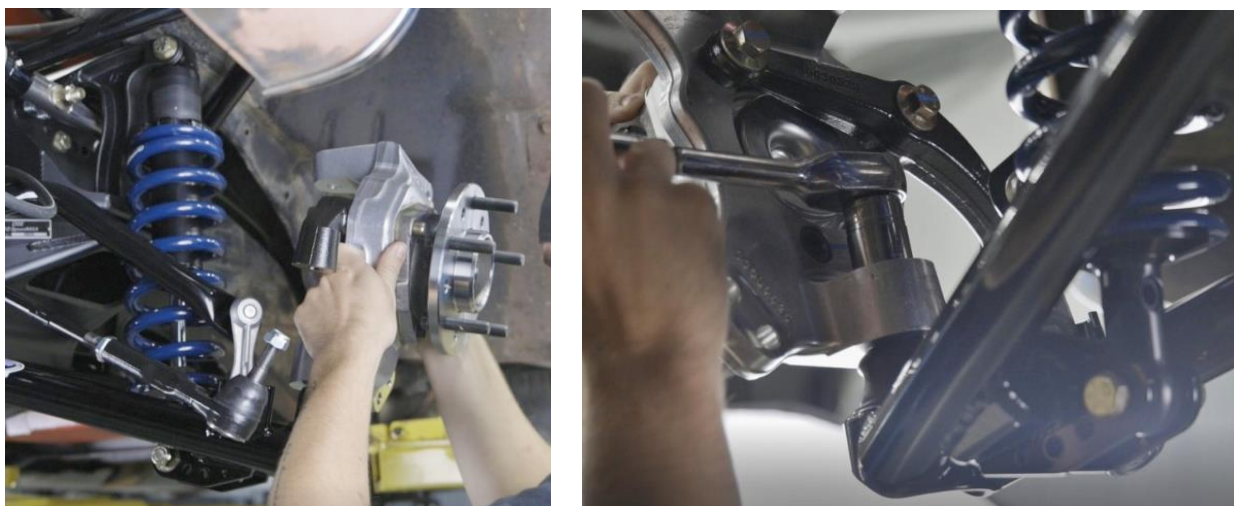

Figure 93 - Install Spindle on Lower Control Arm

103. Move the upper control arm down so the upper ball joint stud passes through the mounting hole in the upright. Install the castle nut onto the ball joint stud and tighten (Figure 94). Do not torque at this time. Repeat this process for the opposite side of the truck.



Figure 94 - Install Upper Ball Joint

104. Remove the Nylock nut from the outer tie rods. With the wheel hubs parallel to the frame rail, adjust the outer tie rods so the ball joint will install into the steering arm mounting hole. Make sure both sides are adjusted equal distance on each side to center the steering. Install the castle nuts onto the outer tie rods (Figure 95). Do not torque at this time.

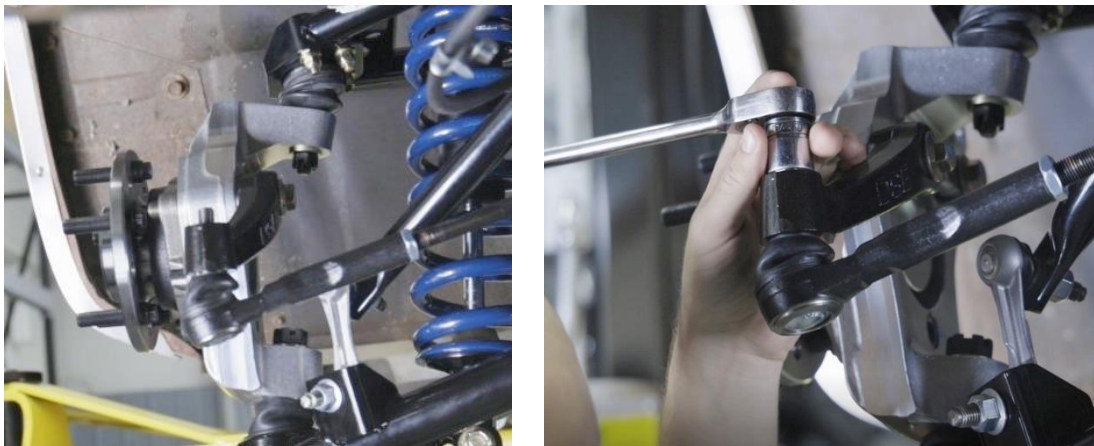

Figure 95 - Install Outer Tie Rods

105. Next, torque the upper ball joint nut to 60 ft-lbs. and then the lower ball joint nut to 100 ft-lbs. Make sure the slot in the castle nut lines up with the cotter pin hole. Install both cotter pins (Figure 96). Repeat this process for the opposite side of the truck.

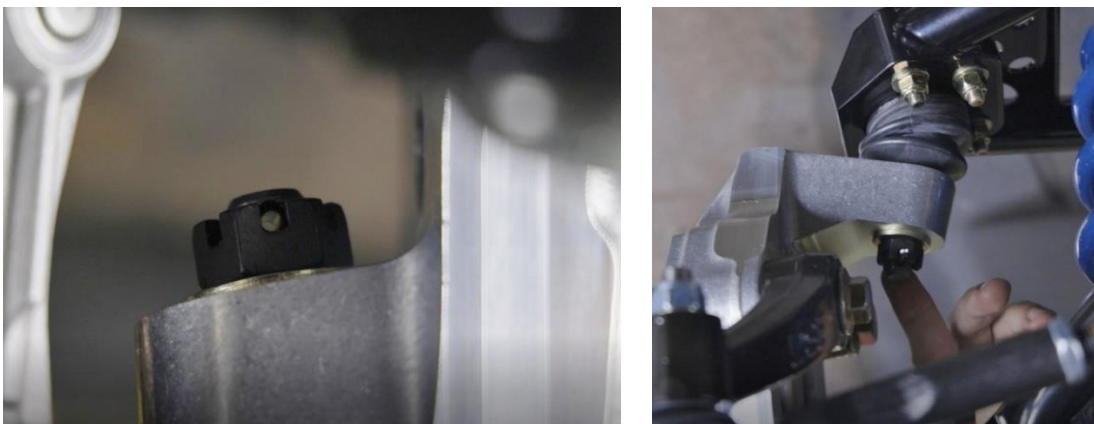

Figure 96 - Install Cotter Pins

106. Torque the outer tie rod castle nut to 44 ft-lbs. Repeat this process for the opposite side of the truck.
107. The DSE C10 SpeedMAX front suspension is assembled at this point. Figure 97 shows a completed installation. Double-check to ensure that all installed components are tight and torqued correctly. **NOTE:** Be sure to lubricate all points on the front frame with quality chassis grease.

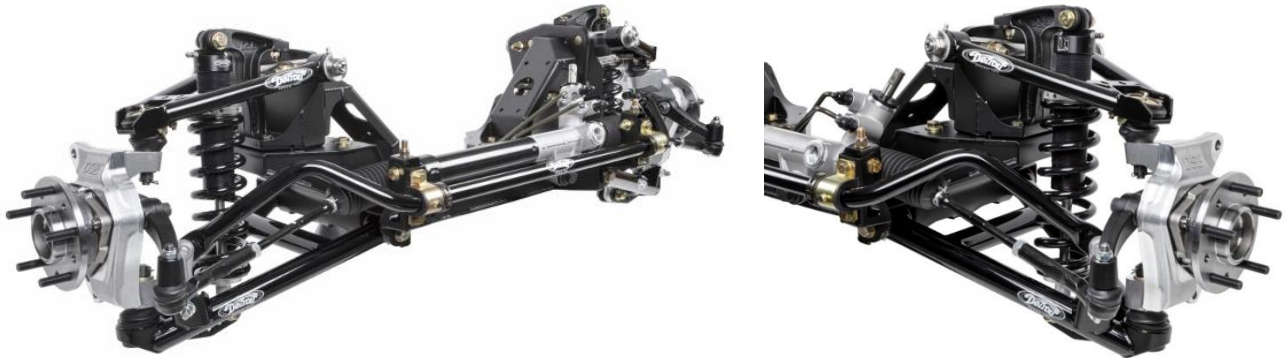

Figure 97 - Completed Installation

108. Re-install the brakes per the manufacturer's instructions. DSE offers 13" front brake rotors for this spindle as PN: 050403DS (Figure 98).



Figure 98 - DSE Brake Rotor

109. Re-install the wheels and lower the truck to the ground. Torque the wheels to the manufacturer's specifications.
110. Once the truck is set on the ground, settle the suspension by jouncing both the front and rear by hand by pressing down on the body and rolling the truck back and forth. Check the ride height at this point and adjust as necessary. Raise the truck up on jack stands and adjust the ride height by turning the coilover spanner nut with the suspension in full droop. Detroit Speed does include a spanner tool to adjust ride height. **NOTE:** Whenever you are setting the truck ride height, DSE recommends disconnecting the sway bar from the truck.

**WARNING: DO NOT ADJUST THE COILOVER ADJUSTING NUT WITHOUT THE TRUCK RAISED OFF THE GROUND TO REMOVE THE WEIGHT OFF THE COILOVER SHOCKS. FAILURE TO FOLLOW THIS PROCEDURE WILL RESULT IN DAMAGED THREADS ON THE SHOCK BODY THAT CANNOT BE WARRANTIED.**

111. Before adjusting the ride height, DSE recommends cleaning the threads of the shock. Once the threads are clean, DSE recommends applying dry bicycle chain lube to the threads of the shock body before adjusting the spanner nut and compressing the coilover spring. Allow the chain lube to dry before adjusting the spanner nut.
112. Once the ride height has been adjusted properly, lock the spanner nut in place. If you have the non-adjustable shocks, tighten the set screw in the spanner nut to the shock body. If you have the adjustable shocks, tighten the lock ring to the spanner nut so they lock together in place.
113. Have a professional alignment completed following the specs given in the chart on Page 2. Installation is now complete.
114. If the upgrade was purchased for the single or double adjustable shocks, refer to the appropriate sections below for adjustability.

### *Detroit Speed Single Adjustable Shock Applications*

To change from the recommended “Detroit Tuned” valving, adjustments can be made independently to the rebound setting. The rebound is controlled by the blue adjuster knob at the upper shock mount (Shock is mounted body side down). The knob rotates clockwise (+) to increase the damping and counterclockwise (-) to decrease the damping. Refer to Figure 99a.



Figure 99a- Detroit Speed Single Adjustable Shock

To return to the Detroit Speed recommended settings, turn the knob clockwise (+) to full damping. Once at full damping, turn counterclockwise (-) to reach the recommended settings. Refer to Figure 99b for the recommended starting setting.

Rebound (Shaft Knob) ..... 20 Open (counterclockwise, -)

Figure 99b - DSE Recommended Setting

### Adjuster Operation

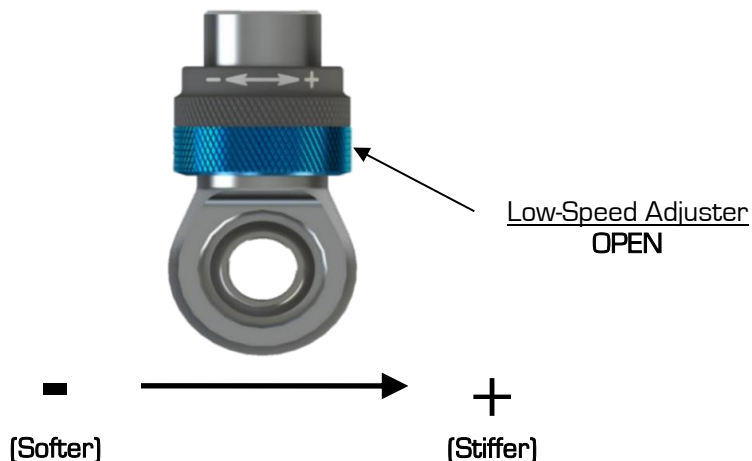

- **Adjuster (60-64 Clicks)**

The low-speed adjuster is a “clicker” style adjuster meaning that its adjustment is measured by detents located inside the blue adjuster knob. There are 16 clicks per 1 revolution of the knob. It uses a right-hand thread in its operation which means as you increase low speed, the adjuster will move up on the eyelet. The recommended change for an adjustment is 8 clicks at a time. The low-speed adjuster’s reference position is **full stiff** (closed, or all the way up) and referred to -0 (-0 = full stiff, -64 = full soft).

- **Tuning Notes**

- **Racetrack**

- For more grip, soften the damping.
- For increased platform control, stiffen the damping.

- **Street**

- For a more comfortable ride, soften the damping

**\*DO NOT FORCE KNOB WHEN IT STOPS TURNING, YOU MAY DAMAGE THE ADJUSTER AND INTERNAL HARDWARE**

### *Detroit Speed Double Adjustable Shocks*

To change from the recommended “Detroit Tuned” valving, adjustments can be made independently to both the high and low speed settings. The rebound is controlled by the sweepers at the lower shock mount. The sweepers rotate clockwise (+) to increase the damping and counterclockwise (-) to decrease the damping. Refer to Figure 100a.



**Figure 100a – Detroit Speed Double Adjustable Shock**

When adjusting the low speed rebound start at full (+) position, when adjusting the high speed rebound start at full (-) position. To return to the Detroit Speed recommended settings turn the sweeper clockwise (+) to full damping for the low-speed setting, and counterclockwise (-) to full damping for the high-speed setting. Once at full damping, turn counterclockwise (-) for the low-speed setting, and clockwise (+) for the high-speed setting to reach the recommended settings. Refer to Figure 100b for recommended starting settings.

Low Speed Rebound (Sweeper)..... 20 sweeps (counterclockwise, -)

High Speed Rebound (Sweeper)..... 2 sweeps (clockwise, +)

**Figure 100b – Detroit Speed Recommended**



## Adjuster Operation

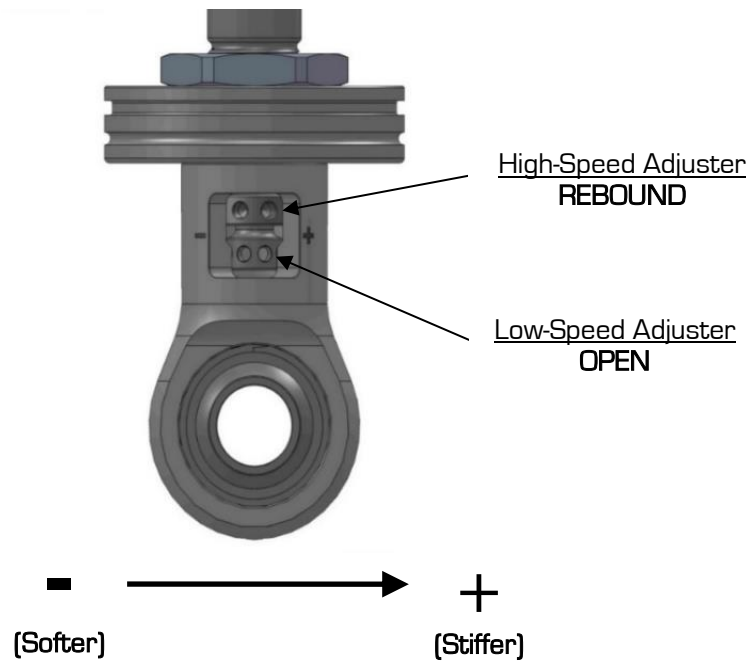

- **High-Speed Adjuster (12 Sweeps)**

The high-speed adjuster is a “sweep” style adjuster meaning that its adjustment is measured by the location of the adjuster in the eyelet window. It uses a left-hand thread in its operation which means; as you increase high-speed, the adjuster will move down in the window\*. The high-speed adjuster’s reference position is **full soft** and referred to as +0 (+0 = full soft, +12 = full stiff).

- **Low-Speed Adjuster (25 Clicks)**

The low-speed adjuster is a “clicker” style adjuster meaning that its adjustment is measured by detent grooves located inside the high-speed shaft. It uses a right-hand thread in its operation which means; as you increase low speed, the adjuster will move up in the window. The low-speed adjuster’s reference position is **full stiff** and referred to -0 (-0 = full stiff, -25 = full soft).

*\*The low-speed adjustment does not change when adjusting the high-speed.*

If you have any questions before or during the installation of this product, please contact Detroit Speed at [sales@detroitsspeed.com](mailto:sales@detroitsspeed.com) or 704.662.3272

**Legal Disclaimer:** Detroit Speed is not liable for personal, property, legal, or financial damages from the use or misuse of any product we sell. The purchaser is solely responsible for the safety and performance of these products. No warranty is expressed or implied.