



INSTALLATION INSTRUCTIONS

HIGH OUTPUT 2 SPEED RAD FAN ASSEMBLY

PART # 66818, 66819, 66820, 66821,
66822, 66823, 66827 & 66828

Please read these instructions completely before beginning installation

FAN SHROUD ASSEMBLY KIT CONTENTS

| QTY. | DESCRIPTION | QTY. | DESCRIPTION |
|------|------------------------|------|-------------------------|
| 1 | Fan Shroud Assembly | 16 | 1/4-20 x 3/4" Hex Bolts |
| 4 | Angle Brackets | 16 | 1/4-20 Lock Nuts |
| 1 | Rubber Fan Shroud Seal | 40 | 1/4" Flat Washers |

IMPORTANT

This fan assembly is designed for PULLER APPLICATIONS ONLY Engine side of radiator. (See Diagram #1)

Diagram #1

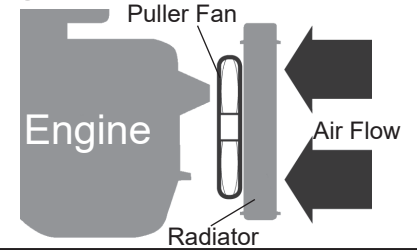

MOUNTING OPTIONS

Diagram #2 Down Flow Radiator

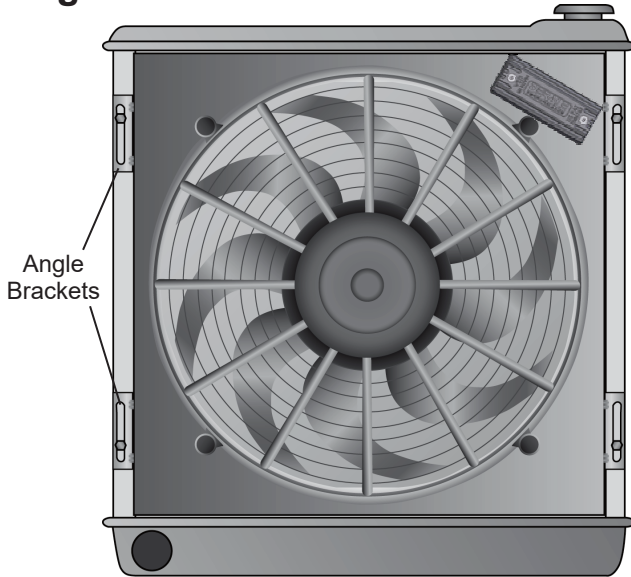

Cross Flow Radiator

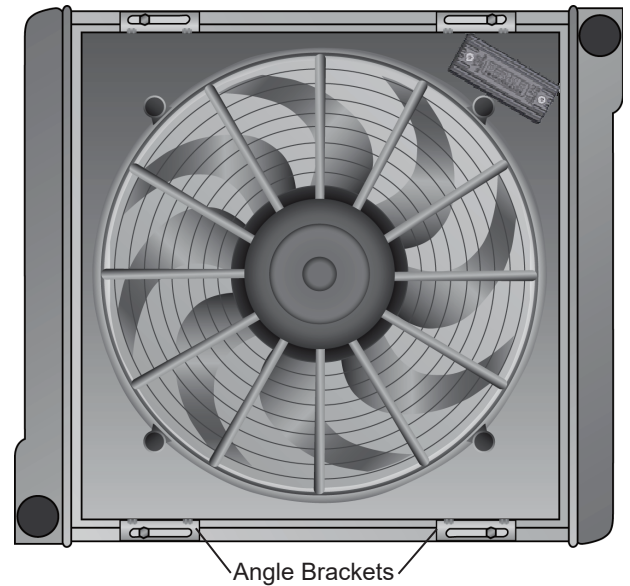
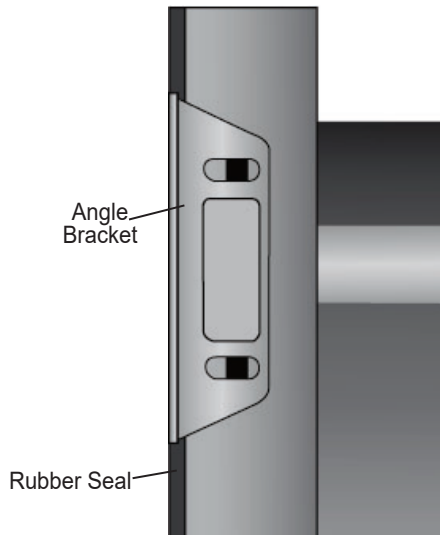
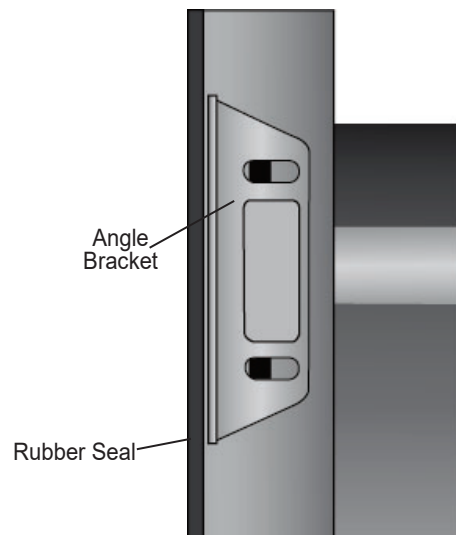

Diagram #3

Option 1 Flush Mount



Option 2 Recessed Mount



INTEGRATED PWM CONTROL MODULE INSTALLATION ON A SINGLE FAN SHROUD



Please read these instructions completely before beginning installation

KIT CONTENTS

| QTY. | DESCRIPTION | QTY. | DESCRIPTION |
|------|---------------------------------------|------|----------------------------|
| 1 | Integrated PWM Fan Controller | 1 | 50 Amp Circuit Breaker |
| 1 | PWM Cover | 1 | 6ft 10 AWG Red Wire |
| 1 | PWM Cover Spacer | 1 | 6ft 10 AWG Black Wire |
| 1 | Corner Mounting Bracket | 1 | 42" 22 AWG Green Wire |
| 3 | #8 Lock Washers | 6 | #10 Sheet Metal Screw |
| 2 | #6 Lock Washers | 2 | Yellow Butt Connector |
| 3 | #8 Nuts | 2 | Yellow 5/16" Ring Terminal |
| 2 | #6 Nuts | 4 | Yellow #8 Ring Terminal |
| 2 | 8-32 x 1/4" Allen Head Bracket Bolts | 2 | Yellow #10 Ring Terminal |
| 2 | 6-32 x 1/4" Allen Head Mounting Bolts | 1 | Red #8 Ring Terminal |
| 2 | 8-32 x 1-1/4" Allen Head Cover Bolts | 2 | Red #6 Ring Terminal |
| 1 | Sensor | 1 | Blue Wire Tap Connector |
| 4 | 4" Wire Ties | | |

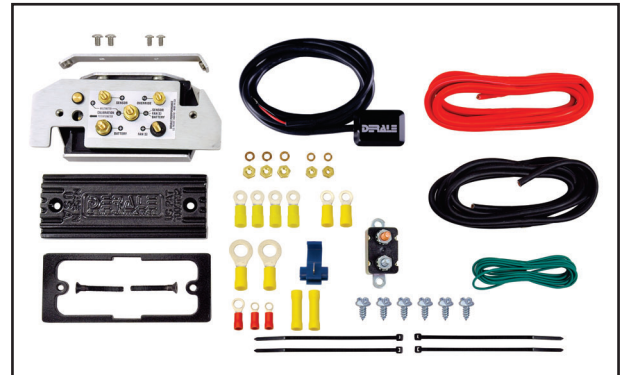

TOOLS NEEDED

| | | | |
|-----------------|-----------------------|-----------------------|--------------------------|
| Drill | Standard Screw Driver | Standard Screw Driver | Wire Crimping Tool |
| 5/32" Drill Bit | 5/16" Nut Driver | (1/8" wide blade) | Allen Wrench Set |
| Multimeter | 11/32" Nut Driver | Wire Stripper | 7/16" Socket and Ratchet |

IMPORTANT NOTES!

This fan controller has been completely quality control tested prior to final packaging.

If for any reason you are having issues with the installation of this fan controller, please refer to the TROUBLESHOOTING section on pages 5 and 6 or view our tech tip videos on our website.

MAXIMUM CAPACITY: 65 AMPS

This controller will operate multiple fans with a combined maximum amperage up to 65 amps. On dual fan applications, it is important to know your fan(s) amp draw before installing, if fan(s) exceed the 65 amp rating, you will void the warranty.

AUTO RESETTING CIRCUIT BREAKER

The fan controller utilizes an auto resetting circuit breaker to protect the fan(s) and controller circuit. In the event of an electrical issue, the breaker will "trip" and open the connection between the battery and the controller. The circuit breaker will automatically reset once the issue has been corrected.

MAIN POWER CONNECTIONS

The positive and negative wires feeding the fan controller MUST be connected directly to the vehicles battery.

This is very important because the controller requires a clean signal, do not connect directly to the fuse panel, starter or the alternator.

VEHICLES BATTERY LOCATION

If the vehicles battery is located more than 5 feet from the fan controller, the signal could encounter some interference or noise, which causes a dirty signal. In some cases, an additional filter may be required.

SENSOR LOCATION

The controller is designed to monitor the coolant going back in to the engine, therefore controlling the engine temperature vs. reacting to it. By design, the sensor MUST be installed on the COLD SIDE of the radiator tank.

This unit is equipped with a newly released aluminum temp sensor that reacts 50% quicker than previous models. It uses 3M double stick tape to adhere right to the radiator tank, therefore getting a very accurate temperature reading. The surface preparation is critical; surface must be absolutely free of dirt, oil, peeling paint or any contaminants to ensure a proper bond.

Important: The ideal application temperature range is 70°F to 100°F (21°C to 38°C). The minimum suggested application temperature is 50°F (10°C). At 70°F approximately 50% of the ultimate bond strength will be achieved after 20 minutes, 90% after 24 hours and 100% after 72 hours.

OVERRIDE CIRCUIT

The fan controller has an override circuit available that when activated, will ramp up the electric fans to 60% running speed. As the engine temperature increases the fans will increase accordingly.

WIRE CONNECTIONS

Crimp connections are critical to the function of this controller, please ensure that all connections are made using quality crimpers. After each crimp has been completed, wiggle wires, there should be no movement within the connector.

FAN CONTROLLER INSTALLATION PROCEDURE ON A SINGLE FAN SHROUD

1. Identify the pieces of the fan controller.

- 1 - PWM fan controller
- 1 - Corner mounting bracket
- 2 - 1/4" allen head bracket bolts



2. Install the bracket onto the fan controller using two 8-32 x 1/4" allen head bracket bolts and an allen wrench.



3. From the backside of the shroud slide the fan controller into the mounting corner. (See Diagram #11 on page 7)



4. From the sides of the shroud thread in two 6-32 x 1/4" allen head bracket bolts (supplied). Using an allen wrench tighten screws.



5. Place fan controller base into position on shroud. To keep the Base in position you may need to tape it temporarily.



6. Install the electric fan & run the wiring to the controller and make connections using the correct size connectors. Please reference wiring instructions on pages 4 & 5 and the quick reference guide on page 7. Fan positive (+) & negative (-) wires can be run through the face of shroud, through the wire holes of the fan controller as shown. The remaining wires can run from the sides of the fan controller.

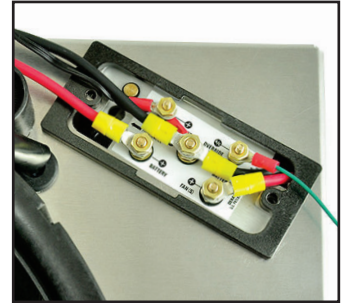

7. Position wires to avoid fan controller cover mounting holes and place cover onto the base. Make sure the wires are all within the sealing foam area of cover. Then align holes and thread-in two 8-32 x 1-1/4" allen head cover bolts using an allen wrench.



Note: The above photos are only to show fan controller installation. Please review wiring instructions on page 4 & 5 and the Wiring Diagram on page 7.

Sensor installation *Page 4*
Circuit breaker mounting *Page 4*
Wiring instructions *Page 4-5*

INSTALLATION OF ELECTRIC FAN ASSEMBLY TO RADIATOR

Before installing shroud Reference Diagrams # 2 & 3 on page 1 to decide how the Assembly should be mounted to radiator.

1. Using a table or workbench, lay the Electric Fan Assembly on a flat surface.
2. Take the supplied Rubber Fan Shroud Seal and install it onto the bottom edge of the Fan Shroud Assembly. (See Diagram #4)
3. Cut off any excess Rubber.
4. Identify the four Angle Brackets, 1/4-20 x 3/4" Hex Bolts, 1/4" Flat Washers & 1/4-20 Lock Nuts.
5. Attach the Angle Brackets to the Shroud using two bolts per bracket. (See Diagram #5)

Note: In some applications where the radiator flange is not right up against the fan shroud, longer bolts can be used to space the Angle Brackets. (See Diagram #6) Hardware not included.

6. Position the Electric Fan Assembly against the radiator in the desired location.
7. Using the remaining 1/4-20 x 3/4" Hex Bolts, 1/4" Flat Washers & 1/4-20 Lock Nuts, attach the Electric Fan Shroud Assembly to the radiator. (See Diagram #5)

Note: In some cases the radiator flange may have to be drilled for proper alignment.

Diagram #4

Fan Shroud Assembly

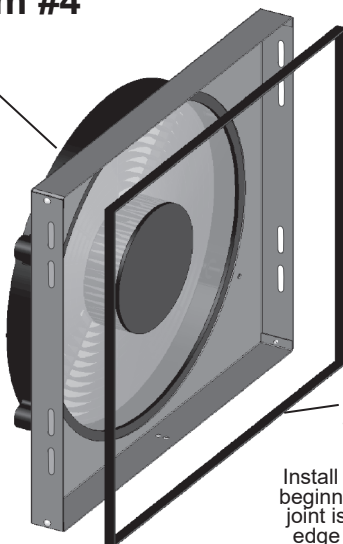

Rubber Fan Shroud Seal

Install Seal so the beginning and end joint is on bottom edge of shroud

Diagram #5

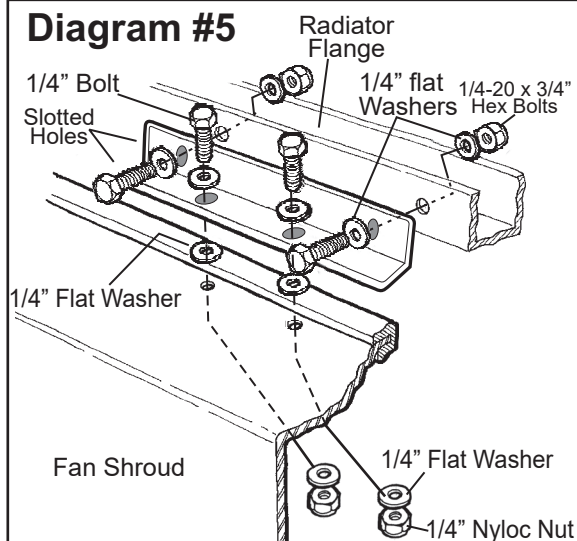
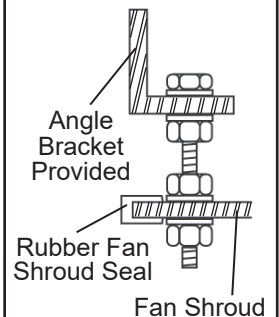

Diagram #6

OPTIONAL MOUNTING



CIRCUIT BREAKER MOUNTING

1. Choose a convenient location for the circuit breaker that is between the fan controller and the battery.
2. Using the circuit breaker as a template, mark and drill two 5/32" holes in the proper locations.
3. Using the remaining two #10 sheet metal screws supplied, secure the circuit breaker in place.

SENSOR INSTALLATION

Route the path of your sensor wires to the fan controller before mounting sensor. If necessary, you can lengthen or shorten sensor wires using an automotive grade 22-gauge wire.

IMPORTANT: The fan controller is designed to monitor the coolant going back in to the engine, therefore controlling the engine temperature vs. reacting to it. By design, the sensor **MUST** install on the **COLD SIDE** of the radiator tank. (See Diagram #7)

This unit uses 3M double stick tape to adhere right to the radiator tank, therefore getting a very accurate temperature reading. The surface preparation is critical; surface must be absolutely free of dirt, oil, peeling paint or any contaminants to ensure a proper bond.

NOTE: The Ideal application temperature range is 70°F to 100°F (21°C to 38°C). The Minimum suggested application temperature is 50°F (10°C). At 70°F approximately 50% of ultimate bond strength will be achieved after 20 minutes, 90% after 24 hours and 100% after 72 hours.

1. Once you have determined the location for the sensor, clean & dry the area with alcohol, making sure there is no left over residue.
2. Remove the red tape backing from the sensor. Attach the sensor to the desired location applying firm pressure on the sensor for at least 15 seconds.
4. Crimp the red #6 ring connector to the sensor red wire.
5. Crimp the #8 red ring connector to the black sensor wire.
6. Connect red sensor wire to the sensor "+" terminal on the fan controller. (See Diagram #9).
7. Connect black sensor wire to the sensor "-" terminal on the fan controller.

WIRING

(See Quick Reference Guide on page 7)

Before starting, disconnect the negative (-) cable on the vehicles battery.

Using the electrical connectors and wire ties provided, follow the instructions below. (See Dia. #8 for proper lug stacking)

WARNING: The positive and negative wires feeding the controller **MUST** be connected directly to the vehicles battery.

This is very important because the controller requires a clean signal, do not connect directly to the fuse panel, starter or the alternator. **Improper installation will void the warranty.**

1. Using a yellow 5/16" ring terminal & 10 AWG red wire supplied, connect one end of the red wire to the vehicles positive (+) terminal on the battery.
2. Route the 10 AWG Red Wire now connected to the battery to the circuit breaker previously installed and cut the wire to the appropriate length.
3. Using a yellow #10 ring terminal, connect the 10 AWG red wire to the "BAT" terminal on the circuit breaker.
4. Using a yellow #10 ring terminal, connect the auxiliary side "AUX" of the circuit breaker to another length of 10 AWG red wire.
5. Route the red 10 AWG wire now connected to the auxiliary side of the circuit breaker to the positive (+) battery terminal on the fan controller and connect using a yellow #8 ring terminal.
6. Using the red 10 AWG wire and a yellow #8 ring terminal, connect into the positive (+) fan terminal on the fan controller.
7. Using a yellow butt connector, connect the loose end of the red 10 AWG wire connected to the positive (+) fan terminal to the positive (+) side Brown wire and Gray wire on the Electric Fan (See Diagram #9 & 10).

Diagram #7

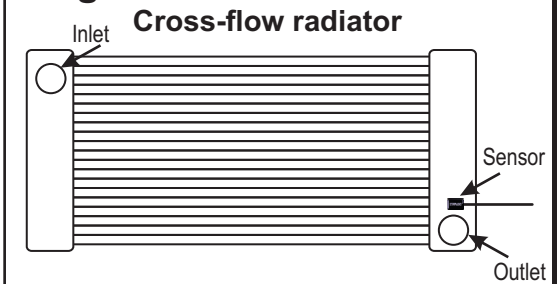

Down-flow radiator

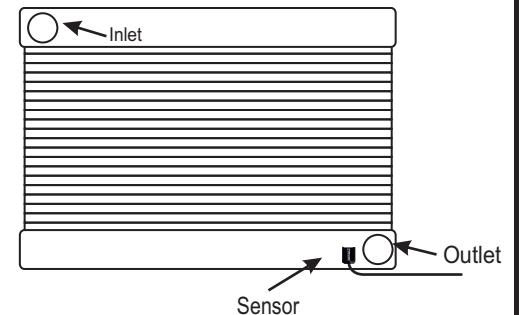
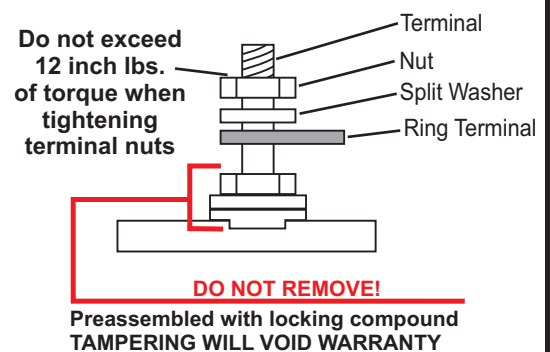

Diagram #8



8. Using a #8 yellow ring terminal, connect the 10 AWG black wire to the negative (-) terminal on the fan controller. Route the other end of the wire to the negative terminal on the vehicles battery & connect using a 5/16" yellow ring terminal. Do not connect to a chassis ground.
9. Using a yellow butt connector, connect the 10 AWG black wire to the negative (-) lead of the fan(s). Route the other end of this wire to the fan (-) terminal of the fan controller & connect using #8 yellow ring terminal.

Green Wire: Override Circuit (Optional)

The green wire is designed to work in two different configurations. When used, this will allow the electric fan(s) to be turned on regardless of the temperature of the cooling system. The fan speed will quickly ramp up to 60% and will operate between 60 and 100% as temperature increases and decreases. Using a #6 red ring terminal connect the Green wire to the A/C terminal and select option A or B below.

Note: Use of the Override terminal is optional and not required for the PWM controller to work properly.

- A. A/C Override - Using the blue wire tap connector provided, attach the green wire to a positive (+) 12V output on the A/C compressor.
- B. Manual Switch Override - Attach the green wire to the 12V output on the manual switch (not provided).

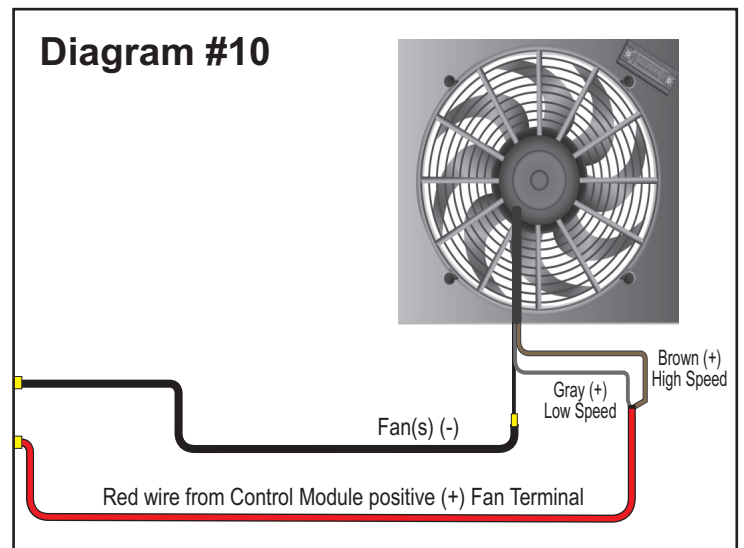
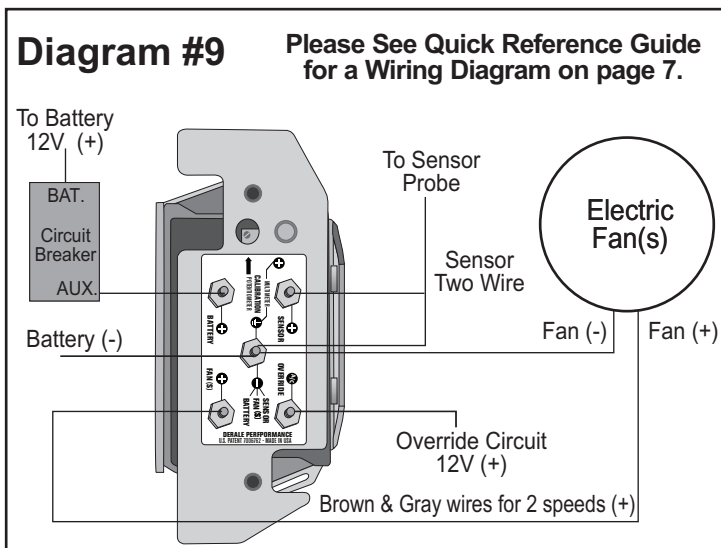

VEHICLE TESTING

1. Before you start the vehicle, make sure all wires are safely zip tied and away from any moving parts.
2. Start the vehicle.
3. If the manual override function is being used, turn on the A/C or manual switch. Electric fan(s) will ramp up to 60%.
4. Turn off the manual override or A/C function and allow the engine to warm up, fans will ramp up slowly as the vehicle warms up.

ADJUSTING THE TURN-ON TEMPERATURE

1. Remove the rubber plug from the top of the fan controller
2. Using a 1/8" blade screwdriver, follow the instructions below:

If your engine is running too cool: Turn the adjustment screw **CLOCKWISE** in increments of 2 FULL turns, then test before repeating.

If your engine is running too hot: Turn the adjustment screw **COUNTER-CLOCKWISE** in increments of 2 FULL turns, then test before repeating.

TROUBLESHOOTING

In the event the fan controller is not operating properly, perform the following tests:

1. Re-check that all wire splices and connections are secure and crimped properly, making sure wires have no movement within the crimp.
2. Using a multimeter, verify that the battery terminal on the fan controller has a minimum of 12.6 volts.

Set the multimeter to: DC Volts

Black Lead: Fan controller center ground terminal

Red Lead: Fan controller positive battery terminal

SYMPTOM: Fan(s) is not turning on when the override function is activated.

TEST: Using a jumper wire, with the vehicle running, connect the battery positive (+) terminal on the fan controller to the A/C override terminal on the fan controller. This should immediately turn on the fan(s).

Pass: The override is working as designed.

Fail: If the fan(s) do not operate, THERE MUST BE A CONNECTION ISSUE, repeat tests 1 and 2 above. If you still can't get it to activate, please call our tech team.

SYMPTOM: The fan(s) are working correctly with the override, but will not turn on with temperature.

TEST: Using a jumper wire, connect the sensor positive (+) terminal on the fan controller to the center sensor ground (-) terminal on the fan controller. This should turn the fan(s) on immediately.

Pass: The fan controller is working as designed.

Fail: Test the sensor

SENSOR TEST: Disconnect the two sensor wires from the fan controller.

Set the multimeter to: Ohms (200K). If you have an auto select multimeter, please manually set the meter to 200K.

IMPORTANT: This test should only be done after the vehicle has cooled off and has been sitting for a few hours.

Black Lead: Connect to the black sensor wire

Red Lead: Connect to the red sensor wire

- A. If the ambient temperature is around 65° F, the meter should read close to 125K ohms
- B. If the ambient temperature is around 75° F, the meter should read close to 100K ohms
- C. If the ambient temperature is around 85° F, the meter should read close to 80K ohms
- D. If the sensor reads 0K Ohms, the sensor is bad and must be replaced, please contact our tech team.

SYMPTOM: Fan(s) are squealing or making a squeaking noise at startup.

TEST: Re-verify that the battery terminal on the fan controller has a minimum of 12.6 volts. See tests 1 and 2 on previous page.

NOTE: If the vehicle's battery is located more than 5 feet from the fan controller, the signal could be encountering some interference or noise, which causes a dirty signal. In some cases an additional electrical filter may be required.

ADJUSTING THE FAN CONTROLLER TO ITS LOWEST SETPOINT: Remove the rubber plug from the top of the fan controller and turn the potentiometer screw 25 FULL turns counter-clockwise. This will set your controller to its lowest set point.

(Page 6)

Warning: Installation of accessories should only be undertaken by those with mechanical knowledge and are familiar with working on vehicles. Always use eye protection (goggles, safety glasses or shield). Park the vehicle in a well lit area, on level ground and apply the parking brake. Only work on a cold vehicle that has been sitting overnight, failure to do so will result in severe burns and injury. Before starting the vehicle, make sure no tools or any other items are left under hood that could interfere with or be drawn into moving parts of the engine. Failure to follow instructions can lead to severe damage and personal injury.

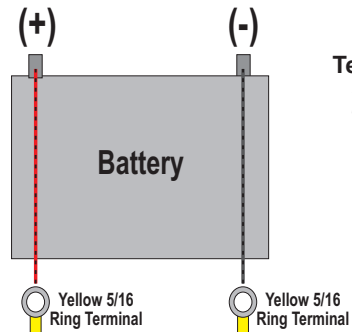

Temperature Adjustment
See instruction sheet for detailed procedures

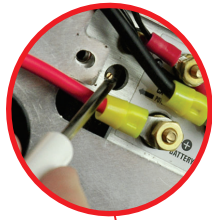

Adjustment Screw

IMPORTANT
Positive and Negative wires must be connected directly to the vehicles battery

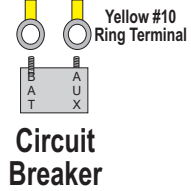

Sensor Wire

IMPORTANT
Sensor must be installed on the cold side of the radiator near outlet

PWM Fan Controller

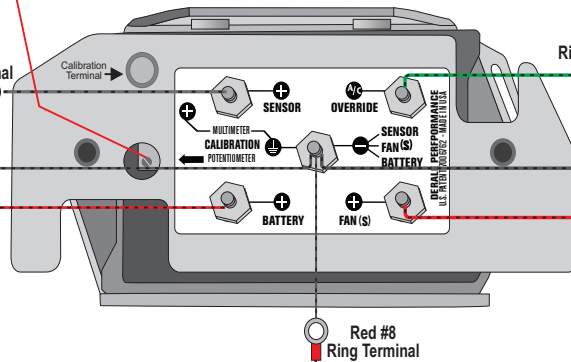

Optional Override Circuit 12V (+)

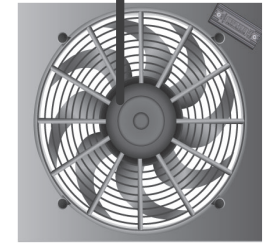
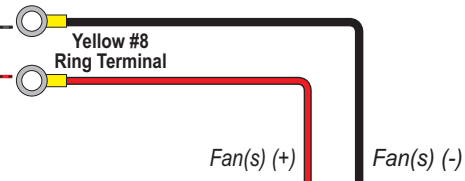
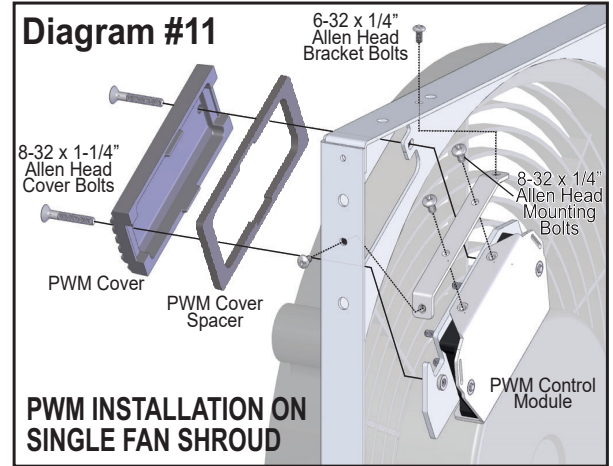

Single Two Speed Electric Fan Setup