

Demco

Chevrolet Equinox



BASEPLATE

Pin height - 14-3/4"

Centers - 24-1/4"

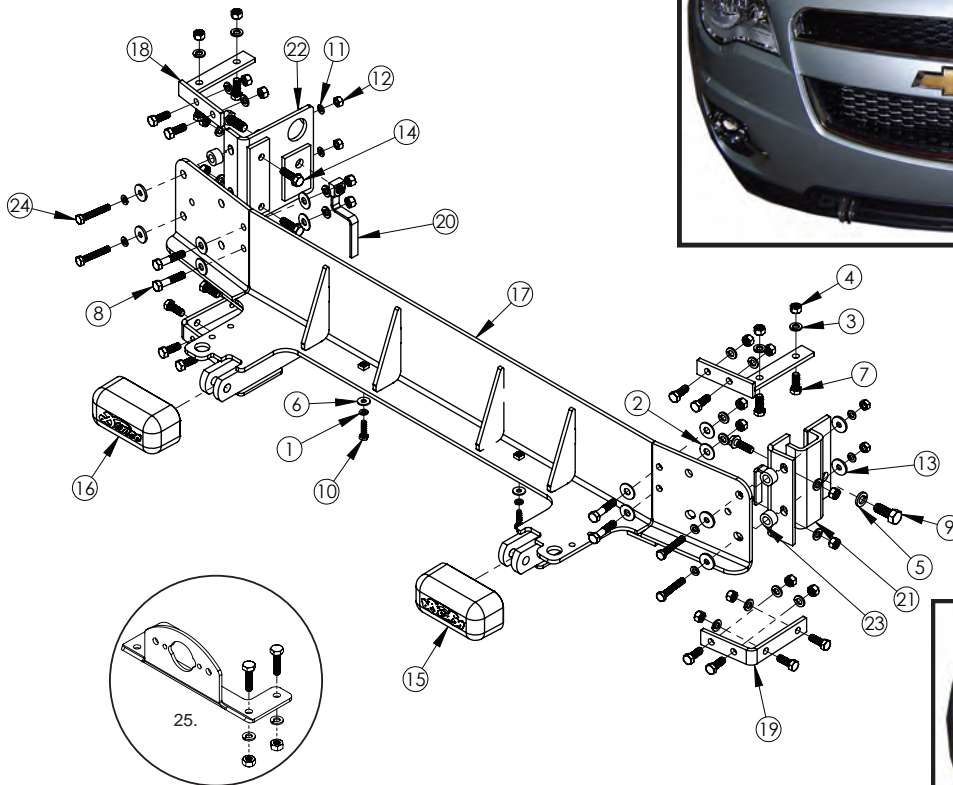

9518254 PARTS LIST

REF. NO.	PART NO.	QTY.	DESCRIPTION
1.	00057	2	1/4" Lock Washer
2.	00059	8	3/8" Flat Washer
3.	00060	24	3/8" Lock Washer
4.	00061	24	3/8" NC Hex Nut
5.	00084	2	1/2" Flat Washer
6.	00214	2	1/4" Flat Washer
7.	00907	16	3/8"-NC x 1" Hex Bolt Gr. 5
8.	00908	4	3/8"-NC x 1-3/4" Hex Bolt Gr. 5
9.	00967	2	1/2"-NC x 1-1/2" Hex Bolt Gr. 5
10.	04055	2	1/4"-NC x 1" Hex Bolt Gr. 5
11.	07286	8	8mm Lock Washer
12.	09032	4	8mm-1.25 Hex Nut

Please order replacement parts by **PART NO.** and **DESCRIPTION.**

REF. NO.	PART NO.	QTY.	DESCRIPTION
13.	09228	8	8mm Fender Washer
14.	11557	4	3/8" - NC x 1 - 1/4" Hex Flange Bolt Gr.5
15.	12979	1	Pull Ear Cover "A"
16.	12980	1	Pull Ear Cover "B"
17.	13565-76	1	Crossmember f/Chevy Equinox
18.	14030-76	2	Top Bracket
19.	14031-76	2	Lower Bracket
20.	14589-76	2	Nut Strip
21.	14590-76	1	Brace Driver Side
22.	14591-76	1	Brace Passenger Side
23.	14592-95	4	Bushing
24.	14593	4	8mm - 1.25 x 50mm Hex Bolt Gr.8.8
25.	5937	1	Plug Mount Kit
26.	12329	3	Loctite (not shown)
27.	14329	1	3/8" Fish Wire

ASSEMBLY
OPERATION
REPLACEMENT PARTS

READ complete manual CAREFULLY
BEFORE attempting operation.

Doing Our Best to Provide You the Best

WARNING: FAILURE TO FOLLOW THESE INSTRUCTIONS CAN RESULT IN LOSS OF TOWING VEHICLE CONTROL, SEPARATION OF THE TOW BAR FROM THE TOWING VEHICLE, SEPARATION OF THE TOWED VEHICLE FROM THE TOW BAR, CAUSING SEVERE PERSONAL INJURY, DEATH, OR PROPERTY DAMAGE.

CAUTION

Safety is of utmost importance at all times. There are several items that must be checked each time before using and while using a tow bar. Before allowing anyone to hook up or operate a tow bar, be sure they have read and understand the proper operating procedure.

DO NOT use worn or damaged cables and/or pins.

Be sure the **SAFETY CABLES** are hooked, chassis to chassis, to both the towing and towed vehicles using the crisscross method.

Check clearance between vehicles in a turning situation.

Check base plate mounting bolts for tightness and frame for metal fatigue.

Do not load the towed vehicle with anything as you may exceed the towing capacity of the tow bar.

Keep fingers away from pivot points to prevent personal injury.

Be sure the steering components of the towed vehicle are properly aligned.

NOTE: This unit can be backed up in moderate increments. Any severe backwards cornering could result in damage to the Tow Bar and/or towed vehicle chassis.

For automatic transmissions: Consult your vehicle owners manual for towing suitability with the drive shaft connected. Otherwise, the towed vehicle will have to be equipped with a transmission pump or drive shaft disconnect.

Check to make sure that all lights are in proper working order.

The information on towability of vehicles is reprinted with permission of MotorHome® Magazine, and is believed to be reliable. However, **Demco does not** warrant the information to be correct. Always consult your towed vehicle owner's manual and follow towing instructions. Each year, **MotorHome® Magazine,** compiles a list of vehicles that can be towed four-down behind a motorhome with no modifications required. This guide contains only those vehicles that have been approved by their manufacturers for towing.

 **Caution: MotorHome® Magazine** left out any vehicles that have towing speed limits slower than 55 m.p.h., or distance limits of less than 200 miles. At a minimum, these vehicles require significant modification, such as the use of an aftermarket product, to make them towable. The availability of a **Demco Tow Bar Base Plate** does not imply that these vehicles can be modified or that there is an aftermarket product available. Refer to your vehicle owner's manual or consult your dealer to determine whether your vehicle can be modified to make it towable. Failure to observe this precaution could result in property damage or personal injury.

IMPORTANT INSTALLATION ITEMS

DEMCO products and accessories are intended to be installed by professional installers with experience, proper equipment and the ability to do modification work. Installers with these qualifications can be found in RV and Automotive Service Centers.

If the car to be towed has been in an accident, the chassis may be damaged in an area where the Base Plate attaches. It may no longer be suitable for towing. Extreme caution and careful examination are required in such a situation. It is also likely, even from a minor accident, that the hole alignment will be more difficult due to hole alignment problems.

Many DEMCO Base Plates are designed to use existing holes and hardware to mount the Base Plate to the towed vehicle. Even though the bolt is there, however, do not assume it is adequate for mounting the Base Plate. Manufacturers make many changes in hardware both within and between model years. Be sure the bolt is long enough to protrude past the nut a distance no less than 1/2 the diameter of the bolt, after the Base Plate is mounted. The threads should be in good condition. **We require that “LOCTITE® Blue” be used on all bolts.** If a new bolt is required, be sure it is SAE Grade 5 or Metric 8.8.

NOTE: The dimensional variations between otherwise identical vehicles can be considerable. Some minor modifications may have to be made to ensure a proper fit.

BOLT TORQUE SPECIFICATIONS

STANDARD BOLTS:			METRIC BOLTS:	
Size	Grade	Torque	Size	Torque
5/16”	5	20 ft/lbs.	8mm	22 ft/lbs.
3/8”	5	35 ft/lbs.	10mm	42 ft/lbs.
7/16”	5	56 ft/lbs.	12mm	70 ft/lbs.
1/2”	5	85 ft/lbs.	14mm	95 ft/lbs.

INSTALLATION INSTRUCTIONS

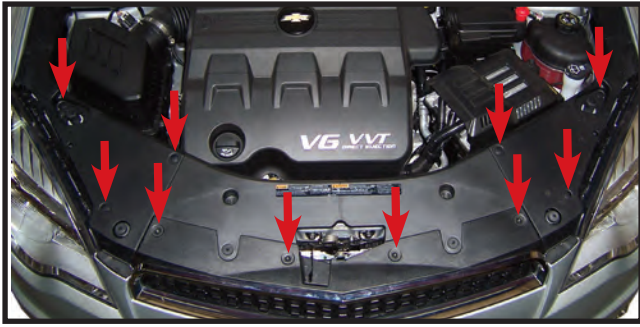

1. Open hood and remove 6 plastic push fasteners and 4 screws from the panel on top of the grille. Remove center plastic cover and hinge outer covers up and back. Lift outer panel to allow grill to be free.



2. Remove three plastic push fasteners and two screws in the front of each fender well.



3. Remove two screws from the bottom of the fascia on each side. Pull out firmly on outer corner of fascia from the front of the fender and remove fascia.



4. With a pliers pinch tabs that hold the wiring harness to the back of the bumper and let hang.

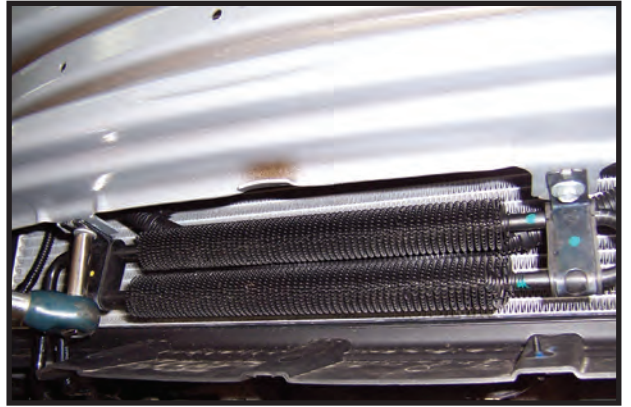

5. **If Equipped** Remove the cooler from the bottom of the bumper and let hang. **Note:** bolts will not be reused.

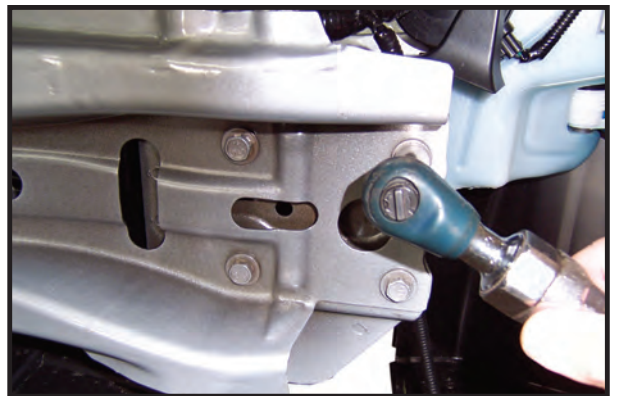

6. Remove four bolts from each side of the bumper and set bumper to the side. **NOTE:** If only three factory bolts are used take factory bolt and use it to tap top inside hole. Then use baseplate as jig to drill hole in bumper to allow bolt to pass through.

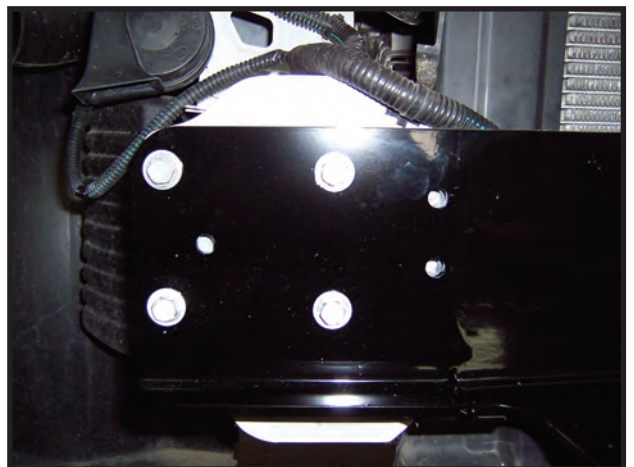

7. With an assistant mount the baseplate into place with the bumper bolts.

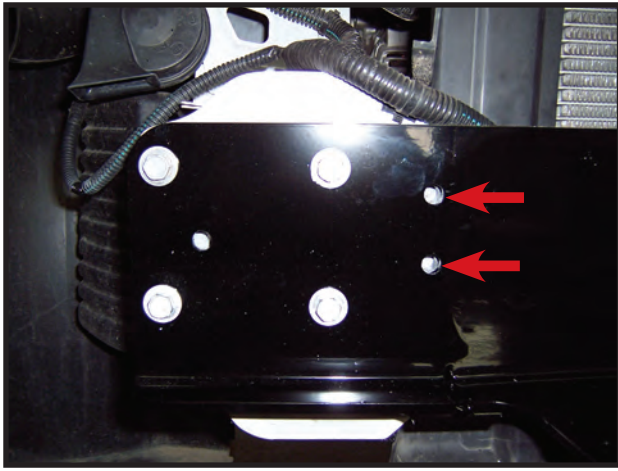

8. Drill two 13/32" holes using the baseplate as a template on each sides.

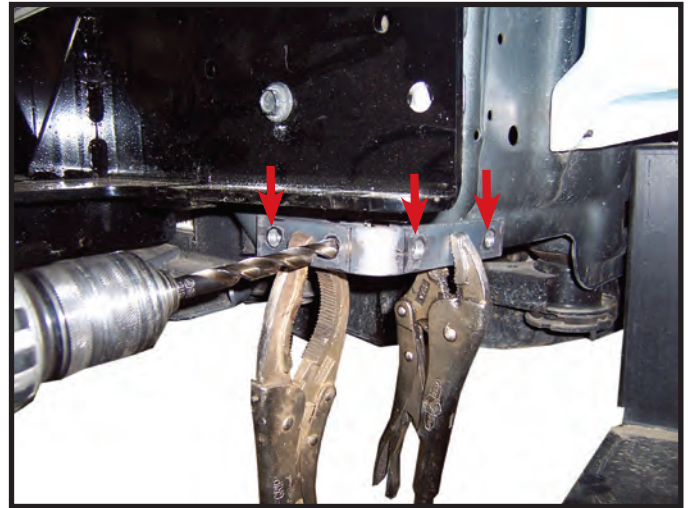

11. Clamp lower bracket to frame as shown. Make sure bracket is flush with bottom of pinch weld. Drill four 13/32" holes using bracket as a template. Repeat on other side.

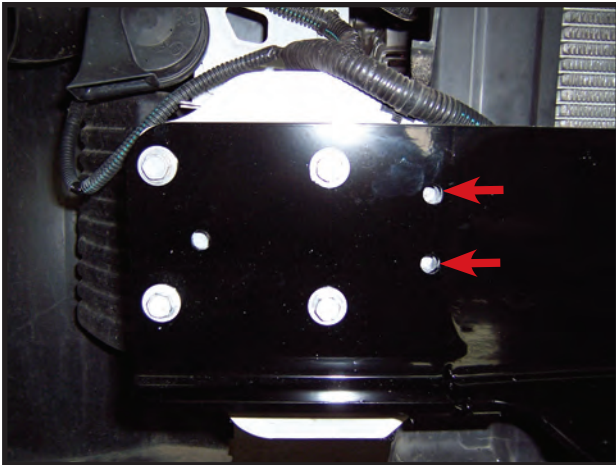

9. Place 3/8 x 1-3/4" with 3/8" flat washers thru drilled holes and place 3/8" flat washer, the 3/8" lock washer and 3/8" nut behind the bumper mount. **NOTE:** Use blue **LOCTITE** on all bolts and tighten all bolts according to chart on front page. Minor trimming of the bumper may be required to let the washers in the front Lay flat against the baseplate.

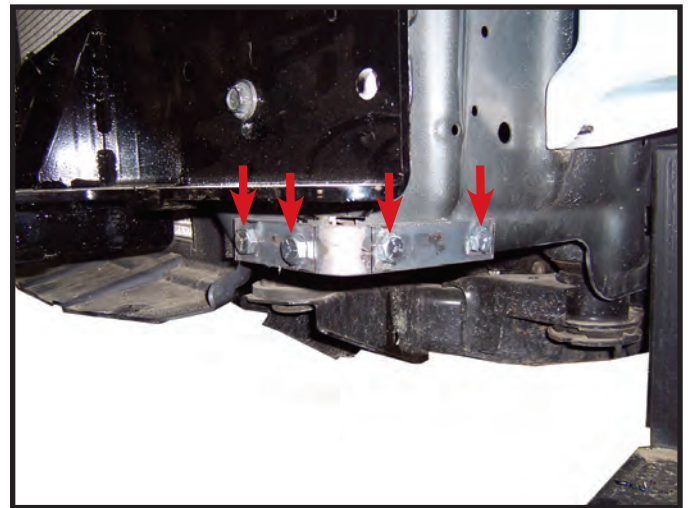

12. Place 3/8 x 1" bolts thru drilled holes and place 3/8" lock washer and 3/8" nut behind frame. **NOTE:** Use blue **LOCTITE** on all bolts and tighten all bolts according to chart on front page.



10. Cut frame below baseplate on each side as shown in picture.

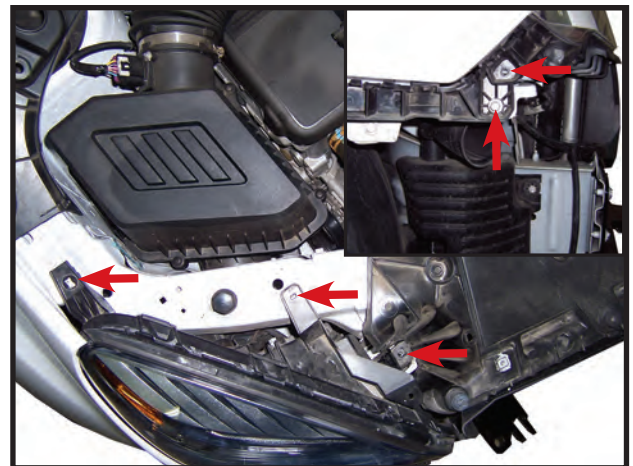

13. Remove three screws from the top of headlight assembly and two from the side (as shown in inserted picture). Pull headlight out and rest on engine. **NOTE:** Some headlights have a hidden tab holding light to fender. Headlight is removed for ease of drilling.

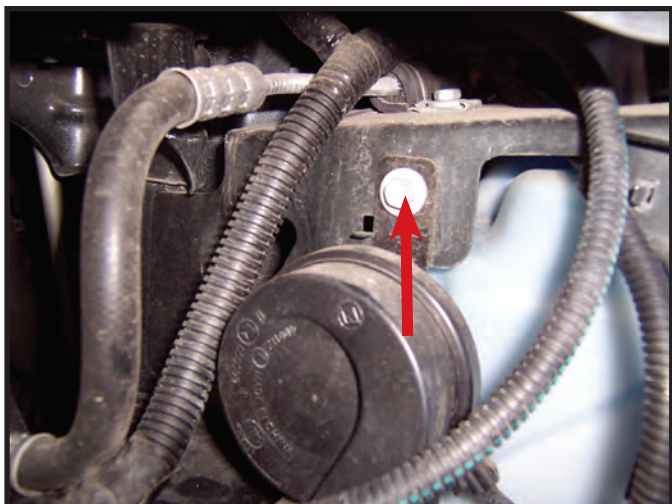

14. Remove one bolt on each side from horn and let hang.

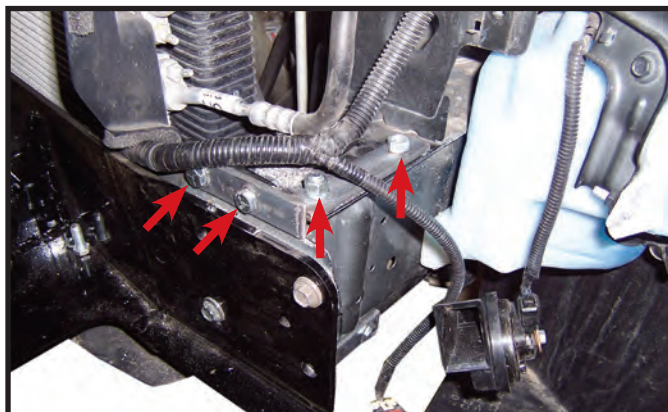

17. Place 3/8 x 1" bolts thru drilled holes and place 3/8" lock washer and 3/8" nut behind frame. **NOTE:** Use blue **LOCTITE** on all bolts and tighten all bolts according to chart on front page. Reinstall bolt holding horn on both sides.

18. Reinstall headlights in reverse order.



15. Cut frame above baseplate on each side as shown in picture.

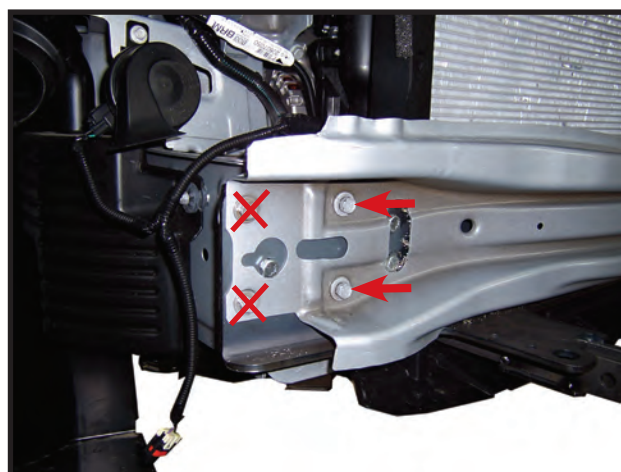

19. Remove factory bumper bolts and reinstall bumper using factory bolts in inside holes of bumper. **NOTE:** Use blue **LOCTITE** on all bolts and tighten all bolts according to chart on front page.

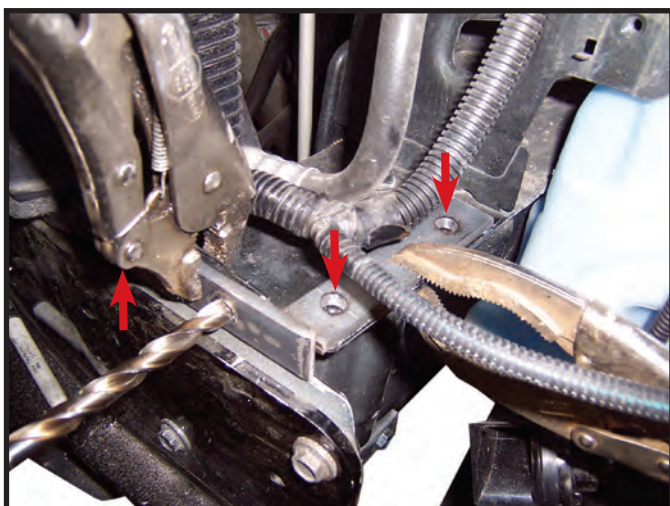

16. Clamp upper bracket to frame as shown. Make sure bracket is flush with the pinch weld on the side. Drill four 13/32" holes using bracket as a template. Repeat on other side.



20. On passenger side remove the two nuts that hold the airbox baffle in place. Remove baffle and set aside.

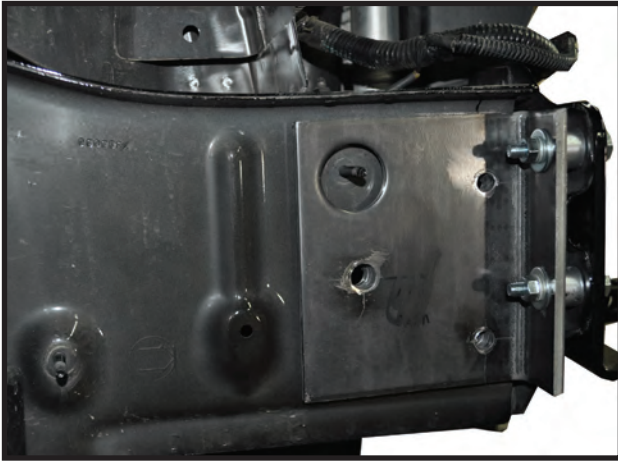

21. Place two bushings over the bumper mount nuts and place passenger side bracket tight to frame and bumper mount. Insert 8mm-1.25 x 50mm bolts, 8mm lock washers, and 8mm flat washers through bumper and passenger bracket. NOTE: Use blue **LOCTITE** on all bolts and tighten all bolts according to chart on front page.

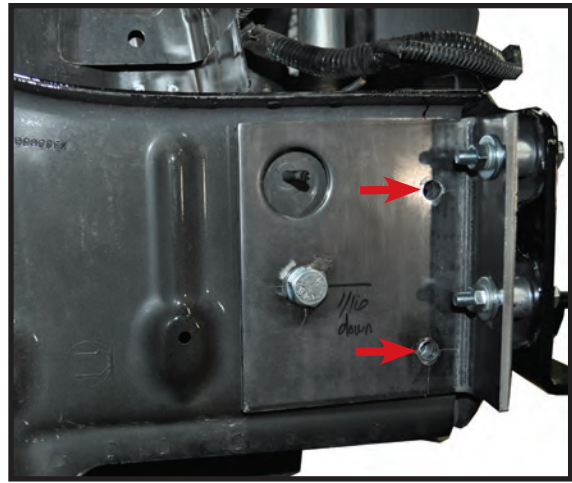

23. Drill two 13/32 holes through the outside of frame using the baseplate as a template.



24. Using the supplied fish wire, fish the 3/8" serrated flange bolts up through the hole in the bottom of the frame as was done with the nutstrip. Fasten the bolts in place using 3/8" lock washers and 3/8" nuts. NOTE: Use blue on all bolts and tighten all bolts according to chart on front page.

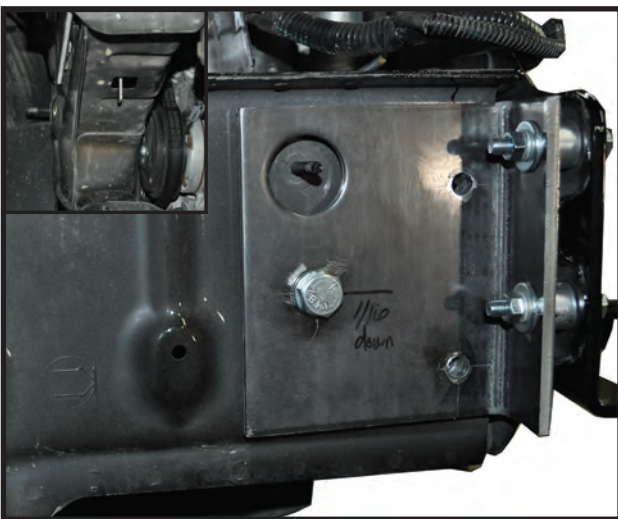

22. Insert 1/2"NC x 1-1/4" bolt and 1/2" lock washer through passenger side bracket and using a nutstrip on inside of frame through hole in bottom of frame as shown in corner picture (leave bolt loose for now). Place 8mm nut, 8mm lock washer, and 8mm flat washer on bolts that come through front of bracket and tighten. Once front nuts are tight then tighten 1/2" bolt. NOTE: Use blue **LOCTITE** on all bolts and tighten all bolts according to chart on front page.

25. Reinstall air box baffle.

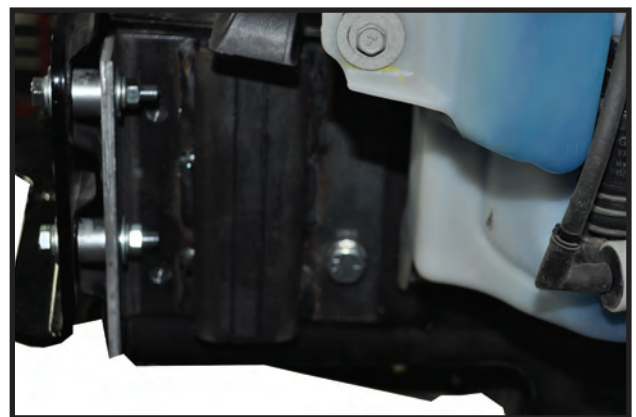

26. Install the driver side bracket in the same ways as on the passenger side. Follow step 21-24 for order of how to install bracket.



27. Route wiring as desired to prevent damage from harness



30. Reinstall hardware and fascia in reverse order as removed. Plug in fog lights if equipped.

31. Plug mount (item #25) may be installed if desired in convenience holes on either chain anchor or as desired.
NOTE: Excess material may be trimmed from bracket.

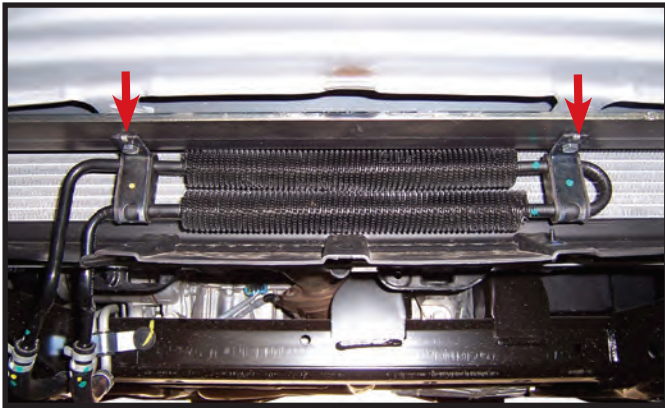

28. **If Equipped** Using the 1/4" x 1 bolts with flat washer and lock washers replace the cooler mounting it to the baseplate in the holes provided as shown.



29. On the rear of the fascia break or cut off the foam tabs from each side to allow fascia to fit properly.