



Ford F-250



BASEPLATE

Pin height - 23"

Centers - 22-1/4"

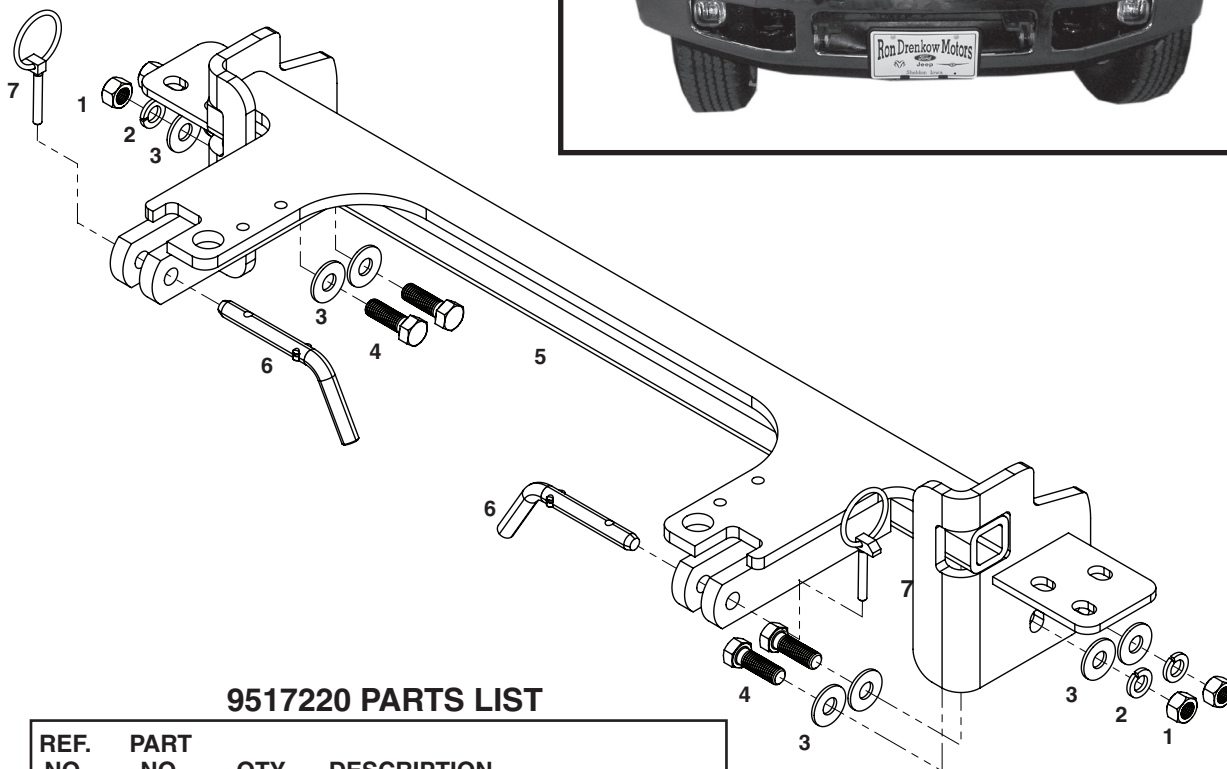

9517220 PARTS LIST

REF. NO.	PART NO.	QTY.	DESCRIPTION
1.	00083	4	1/2" Hex Nut
2.	00084	4	1/2" Lock Washer
3.	00085	8	1/2" Flat Washer
4.	01254	4	1/2" NC x 1-1/2 Hex Bolt Gr.5
5.	12819-76	1	Base Plate Crossmember
6.	10423-91	2	Pull Ear Attaching Pin
7.	02397	2	Lynch Pin
8.	12329	1	Loctite (not shown)

Please order replacement parts by PART NO. and DESCRIPTION.

ASSEMBLY
OPERATION
REPLACEMENT PARTS

READ complete manual CAREFULLY
BEFORE attempting operation.

Doing Our Best to Provide You the Best

WARNING: FAILURE TO FOLLOW THESE INSTRUCTIONS CAN RESULT IN LOSS OF TOWING VEHICLE CONTROL, SEPARATION OF THE TOW BAR FROM THE TOWING VEHICLE, SEPARATION OF THE TOWED VEHICLE FROM THE TOW BAR, CAUSING SEVERE PERSONAL INJURY, DEATH, OR PROPERTY DAMAGE.

CAUTION

Safety is of utmost importance at all times. There are several items that must be checked each time before using and while using a tow bar. Before allowing anyone to hook up or operate a tow bar, be sure they have read and understand the proper operating procedure.

DO NOT use worn or damaged cables and/or pins.

Be sure the **SAFETY CABLES** are hooked, chassis to chassis, to both the towing and towed vehicles using the crisscross method.

Check clearance between vehicles in a turning situation.

Check base plate mounting bolts for tightness and frame for metal fatigue.

Do not load the towed vehicle with anything as you may exceed the towing capacity of the tow bar.

Keep fingers away from pivot points to prevent personal injury.

Be sure the steering components of the towed vehicle are properly aligned.

NOTE: This unit can be backed up in moderate increments. Any severe backwards cornering could result in damage to the Tow Bar and/or towed vehicle chassis.

For automatic transmissions: Consult your vehicle owners manual for towing suitability with the drive shaft connected. Otherwise, the towed vehicle will have to be equipped with a transmission pump or drive shaft disconnect.

Check to make sure that all lights are in proper working order.

The information on towability of vehicles is reprinted with permission of MotorHome® Magazine, and is believed to be reliable. However, **Demco does not** warrant the information to be correct. Always consult your towed vehicle owner's manual and follow towing instructions. Each year, **MotorHome® Magazine,** compiles a list of vehicles that can be towed four-down behind a motorhome with no modifications required. This guide contains only those vehicles that have been approved by their manufacturers for towing. **This list is enclosed with this manual.**

 **Caution: MotorHome® Magazine** left out any vehicles that have towing speed limits slower than 55 m.p.h., or distance limits of less than 200 miles. At a minimum, these vehicles require significant modification, such as the use of an aftermarket product, to make them towable. The availability of a **Demco Tow Bar Base Plate** does not imply that these vehicles can be modified or that there is an aftermarket product available. Refer to your vehicle owner's manual or consult your dealer to determine whether your vehicle can be modified to make it towable. Failure to observe this precaution could result in property damage or personal injury.

IMPORTANT INSTALLATION ITEMS

Demco products and accessories are intended to be installed by professional installers with experience, proper equipment and the ability to do modification work. Installers with these qualifications can be found in RV and Automotive Service Centers.

If the car to be towed has been in an accident, the chassis may be damaged in an area where the Base Plate attaches. It may no longer be suitable for towing. Extreme caution and careful examination are required in such a situation. It is also likely, even from a minor accident, that the hole alignment will be more difficult due to hole alignment problems.

Many Demco Base Plates are designed to use existing holes and hardware to mount the Base Plate to the towed vehicle. Even though the bolt is there, however, do not assume it is adequate for mounting the Base Plate. Manufacturers make many changes in hardware both within and between model years. Be sure the bolt is long enough to protrude past the nut a distance no less than 1/2 the diameter of the bolt, after the Base Plate is mounted. The threads should be in good condition. **We require that “*LOCTITE®* Blue” be used on all bolts.** If a new bolt is required, be sure it is SAE Grade 5 or Metric 8.8.

NOTE: The dimensional variations between otherwise identical vehicles can be considerable. Some minor modifications may have to be made to ensure a proper fit.

BOLT TORQUE SPECIFICATIONS

STANDARD BOLTS:			METRIC BOLTS:	
Size	Grade	Torque	Size	Torque
5/16"	5	20 ft/lbs.	8mm	22 ft/lbs.
3/8"	5	35 ft/lbs.	10mm	42 ft/lbs.
7/16"	5	56 ft/lbs.	12mm	70 ft/lbs.
1/2"	5	85 ft/lbs.	14mm	95 ft/lbs.

INSTALLATION INSTRUCTIONS

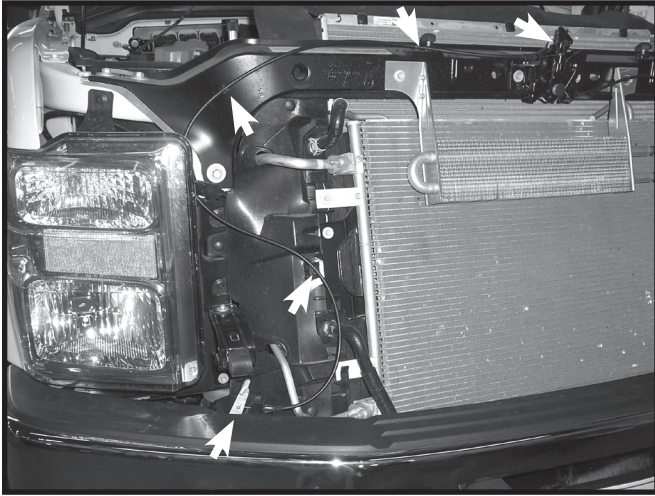

1. Open hood, check to see if you hood release cable latch is mounted directly to bumper, if not, go to step 3. If latch is connect to bumper, remove three cable tie-downs and remove cable from hood latch assembly.

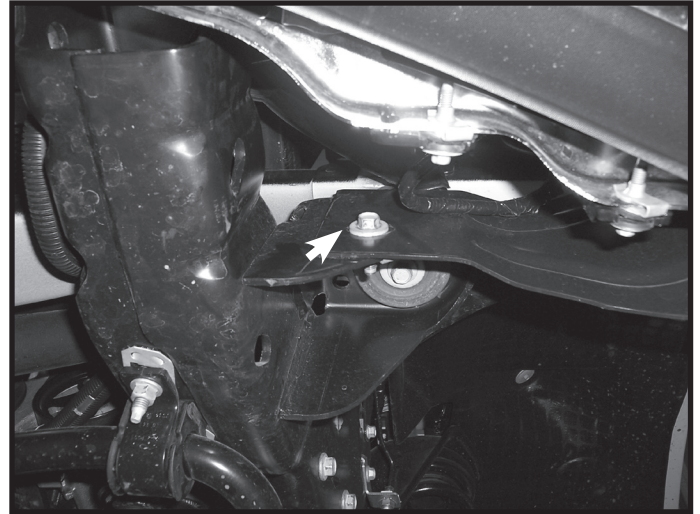

4. Remove one bolt from rear bumper brace on each side. Some models may have two bolts.

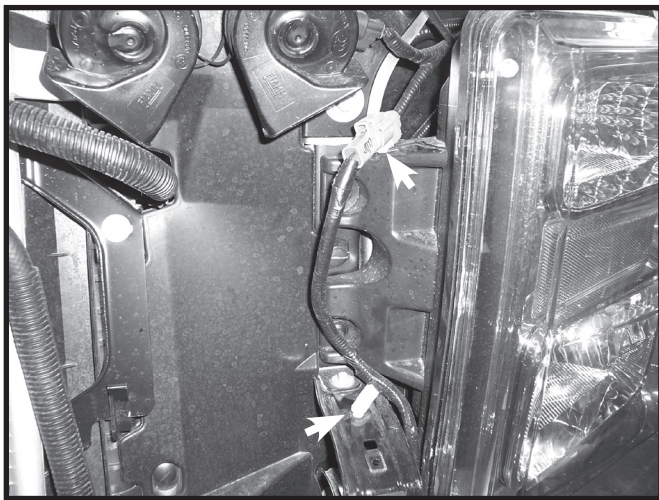

2. If attached to the bumper unplug wire harness by driver's side headlight. Remove wire tie-down from bracket.



5. Remove four bumper bolts, two on each side, and remove bumper.

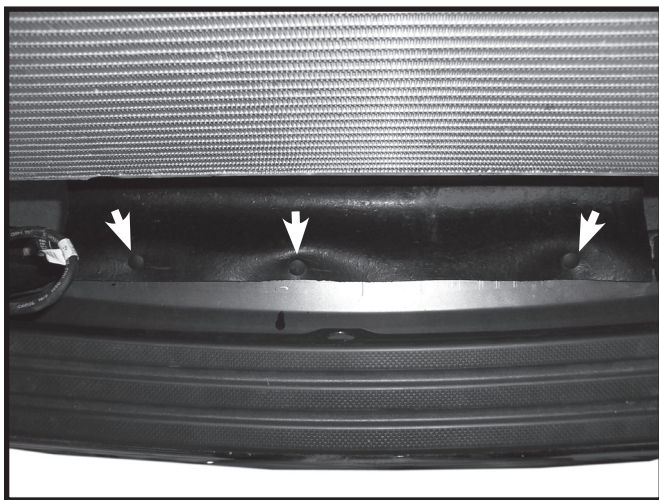

3. Remove three plastic push fasteners from bottom rubber flap and bumper. Some models will not have this rubber flap.



6. Remove the two inner bolts from the lower bumper brace. Remove brace if needed for frame width.

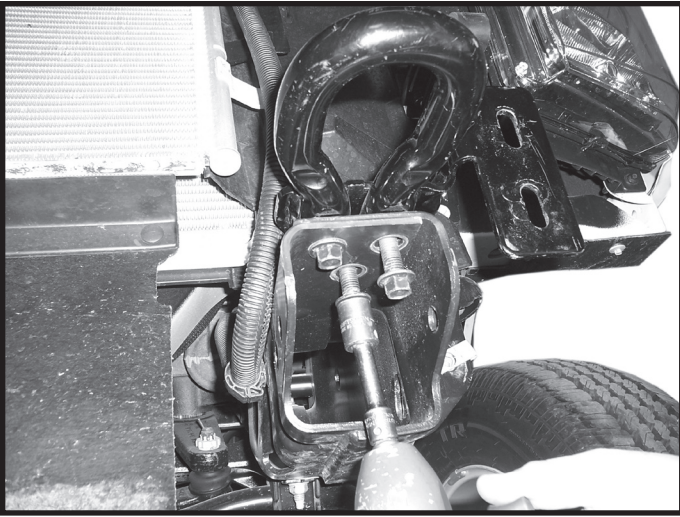

7. Remove three bolts from tow hooks and set tow hooks aside. These bolts will be reused.



10. Reinstall bumper and all hardware in reversed order it was removed. When reinstalling cooler lines in mount, be sure there is enough clearance between cooler lines and base plate, a rubber hose can be used on lines to protect them.

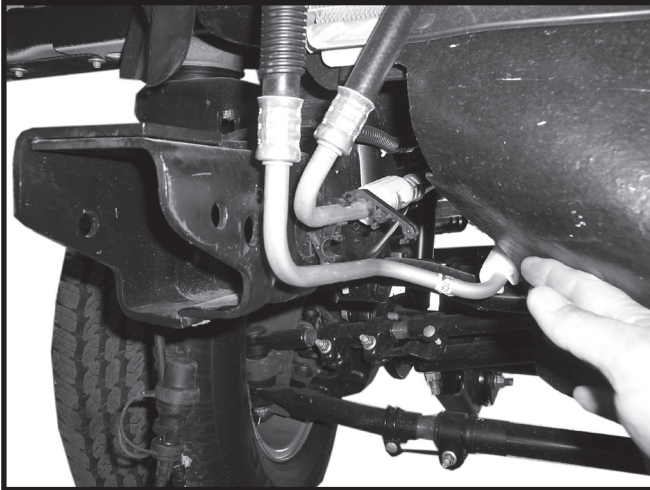

8. Release cooler lines from line mount for installation of base plate.

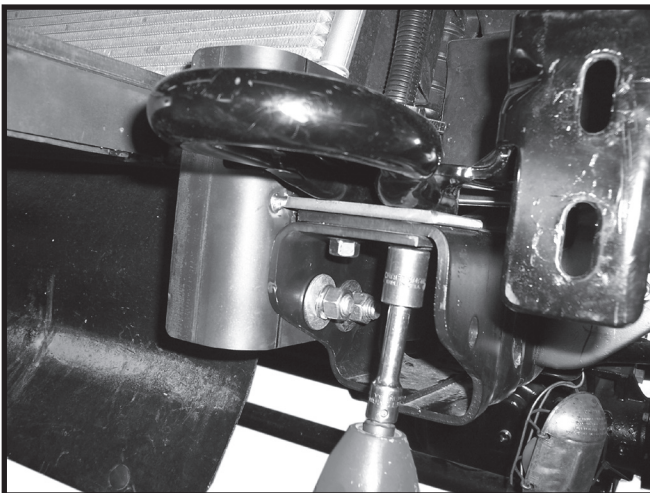

9. Install baseplate between frame rails. Fasten base plate using four 1/2" NC x 1-1/2" hex bolts, eight 1/2" flat washers, four 1/2" lock washers and four 1/2" hex nuts. Install tow hooks on top of baseplate and fasten with previously removed tow hook bolts. **NOTE:** Use **LOCTITE®** Blue on bolts.

Demco

Find out more trailer hitches and towing we have.