



(W)

INSTALLATION INSTRUCTIONS

90-DEGREE BENT END SIDEBARS

2015 CHEVY COLORADO/GMC CANYON

PART # DZ 372031; DZ 372033; DZ 372041; DZ 372043

PARTS LIST:

1	Driver/left Sidebar	4	1/2" x 2" Hex Bolts
1	Passenger/right Sidebar	4	1/2" x 1-1/4" OD x 3/32" Flat Washers
1	Driver/left Front Mounting Bracket	4	1/2" Lock Washers
1	Passenger/right Front Mounting Bracket	12	8mm Clip Nuts
1	Driver/left Front Support Bracket	16	8-1.25mm x 25mm Hex Bolts
1	Passenger/right Front Support Bracket	16	8mm x 24mm OD x 2mm Washer
2	Center Brackets (use left or right)	16	8mm Lock Washers
1	Driver/left Rear Mounting Bracket	4	6-1.0mm x 20mm Hex Bolts
1	Passenger/right Rear Mounting Bracket	4	6mm x 18mm OD x 1.6mm Flat Washers

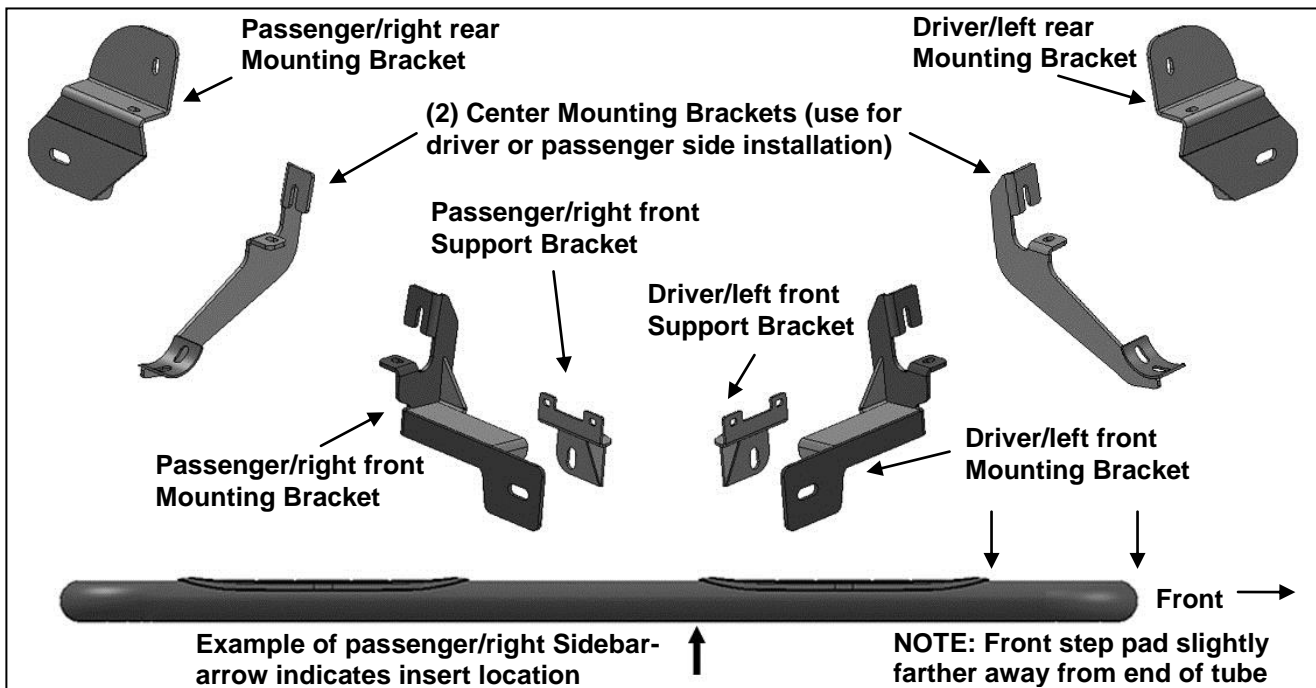

PROCEDURE:

REMOVE CONTENTS FROM BOX. VERIFY ALL PARTS ARE PRESENT. READ INSTRUCTIONS CAREFULLY BEFORE STARTING INSTALLATION. ASSISTANCE IS RECOMMENDED.

1. Start the installation under the passenger side of the vehicle. Locate the 4 factory running board mounting locations along the bottom and inner side of the body, **(Figure 1)**. Mounting Brackets will bolt to the 1st, 2nd and 4th mounting locations. **NOTE:** It may help to hold a Bracket up in place to help determine the mounting holes to use along the bottom and inner side of the body.
2. Move to the front mounting location at the bottom corner of the body. Remove the rubber plugs from the bottom and side of the body panel as necessary, **(Figure 2)**. Select (2) 8mm Clip Nuts. Slide the Clip Nuts into the large holes and over the smaller holes. Line up the threaded nut on the Clip Nut with smaller hole in body panel, **(Figure 3)**.
3. Select the passenger side front Mounting Bracket. Line up the holes in the Bracket with the (2) Clip Nuts. Attach the Bracket to the Clip Nuts with (2) 8mm Hex Bolts, (2) 8mm Lock Washers and (2) 8mm Flat Washers, **(Figure 4)**. Leave hardware loose at this time
4. Next, carefully pull back the plastic lower fender cover and remove the (2) factory bolts in the bottom of the fender, **(Figure 5)**. Select the passenger front Support Bracket, **(Figure 6)**. Attach the Bracket to the (2) threaded holes with (2) 6mm x 20mm Hex Bolts and (2) 6mm Flat Washers, **(Figure 7)**. **IMPORTANT:** Make sure the Support Bracket is behind the front Bracket. Snug but do not fully tighten hardware at this time.

5. Move along the side of the vehicle to the second mounting location, **(Figure 1)**. Repeat **Step 2** to install (2) 8mm Clip Nuts in the (2) factory holes in the body panel, **(Figure 7)**. Select (1) Center Bracket.
NOTE: Center Bracket can be installed on either the driver or passenger side. Bolt the Mounting Bracket to the (2) Clip Nuts with (2) 8mm Hex Bolts, (2) 8mm Lock Washers and (2) 8mm Flat Washers, **(Figure 8)**. Snug but do not fully tighten the hardware.
6. Skip the third mounting location and move to the last location at the back of the cab, **(Figure 9)**. Repeat **Step 4** to install the passenger side rear Mounting Bracket, **(Figure 10)**.
7. Select the passenger/right Sidebar. Carefully position the Sidebar up to the front and rear Mounting Brackets. Attach the Sidebar to the Mounting Brackets with (2) 1/2" x 2" Hex Bolts, (2) 1/2" Lock Washers, and (2) 1/2" Flat Washers, **(Figures 10 & 12)**. Snug but do not tighten at this time.
8. Move to the Center Bracket. Line up the Bracket with the threaded inserts in the bottom of the Sidebar. Attach the Sidebar to the Bracket with (2) 8mm x 25mm Hex Bolts, (2) 8mm Lock Washers and (2) 8mm Flat Washers, **(Figure 11)**. Do not tighten hardware.
9. Level and adjust the Sidebar and tighten all hardware.
10. Repeat **Steps 1—9** to install the driver/left Sidebar.
11. Do periodic inspections to the installation to make sure that all hardware is secure and tight.

To protect your investment, wax this product after installing. Regular waxing is recommended to add a protective layer over the finish. Do not use any type of polish or wax that may contain abrasives that could damage the finish.

For stainless steel: Aluminum polish may be used to polish small scratches and scuffs on the finish. Mild soap may be used also to clean the Sidebar.

For gloss black finishes: Mild soap may be used to clean the Sidebar.

Passenger/right Side Installation Pictured

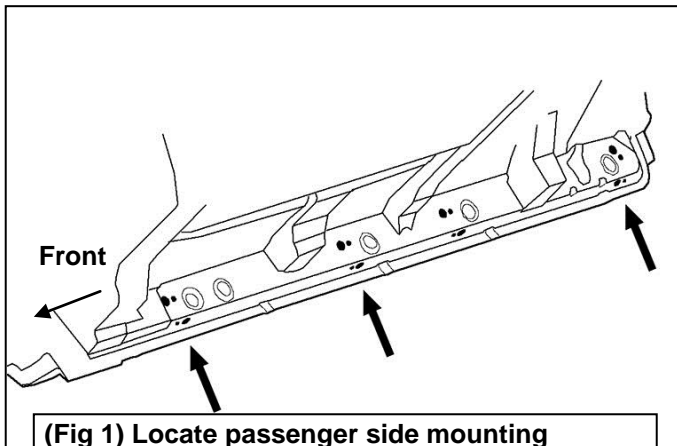

(Fig 1) Locate passenger side mounting locations along bottom and back of body panel

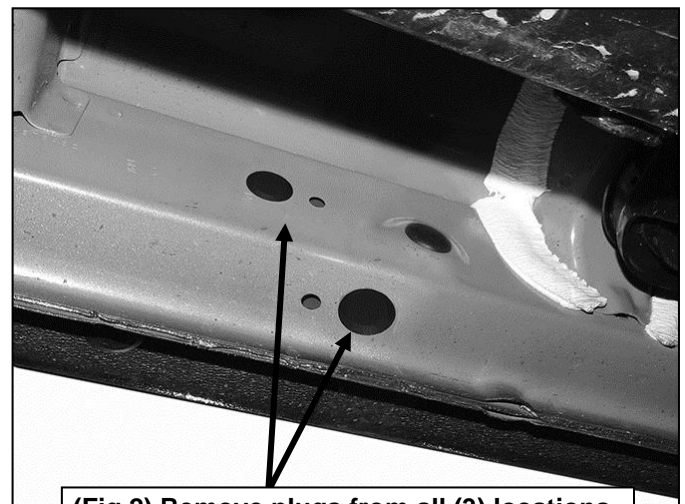

(Fig 2) Remove plugs from all (3) locations

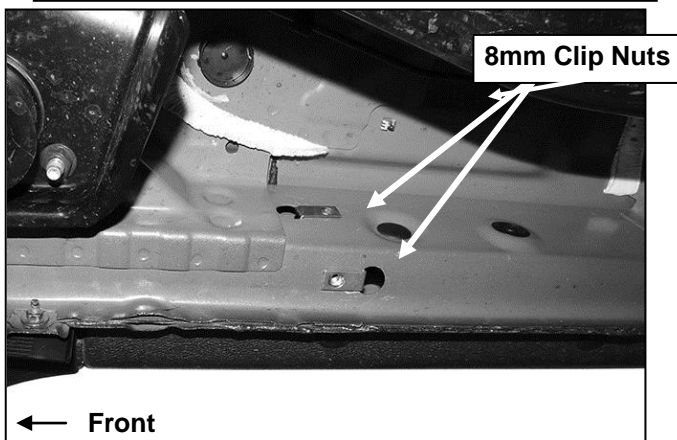

(Fig 3) Slide 8mm Clip Nut into large hole and over small hole. Passenger front location pictured

Passenger/right Side Installation Pictured

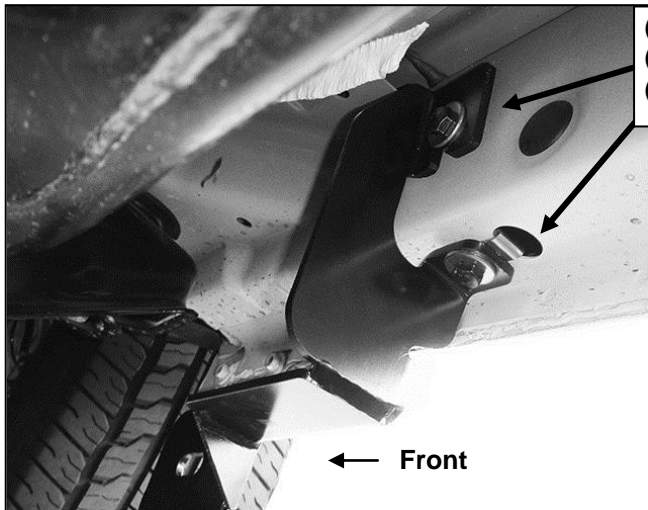

(Fig 4) Attach passenger front Bracket to Clip Nuts

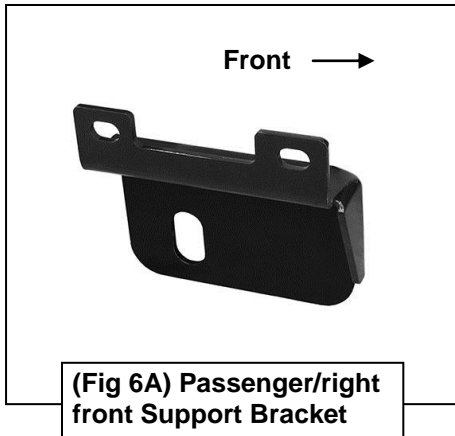
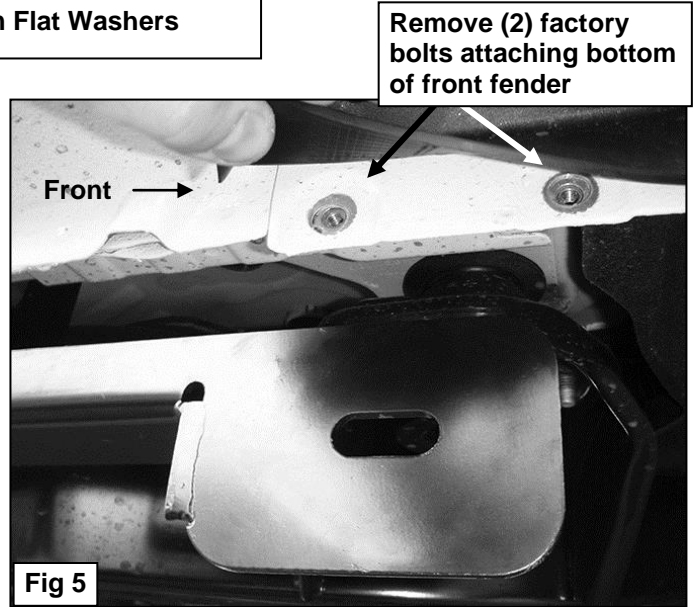

(2) 6mm x 20mm Hex Bolts
(2) 6mm Flat Washers

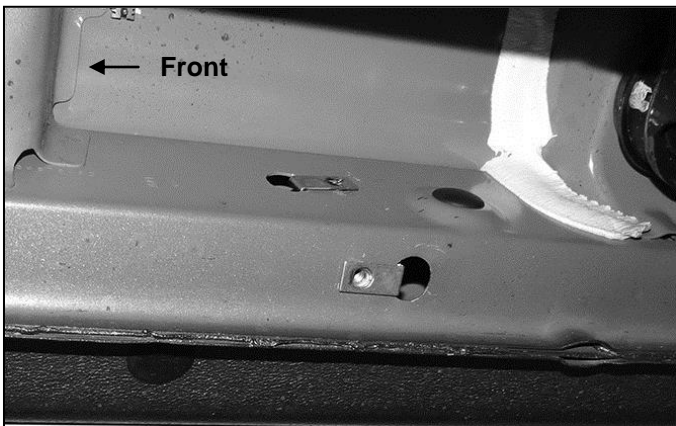
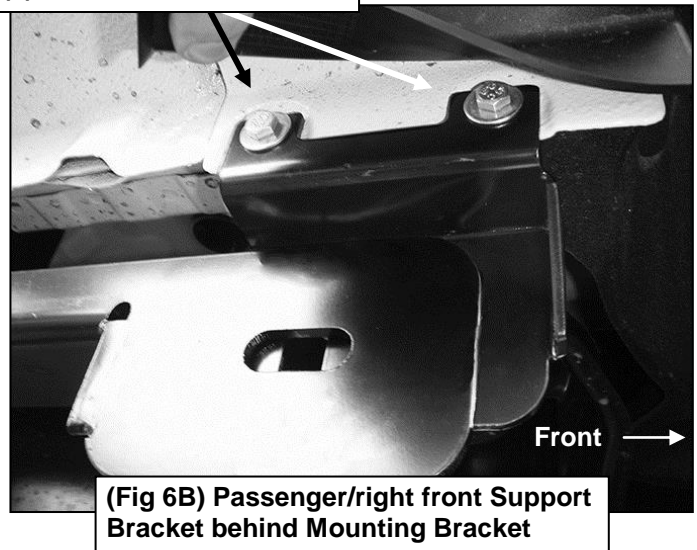

(Fig 7) Passenger/right center location pictured with Clip Nuts

Passenger/right Side Installation Pictured

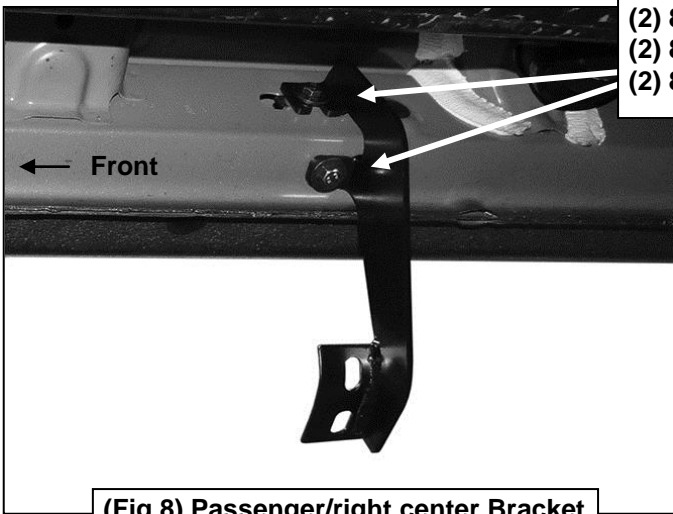

(Fig 8) Passenger/right center Bracket

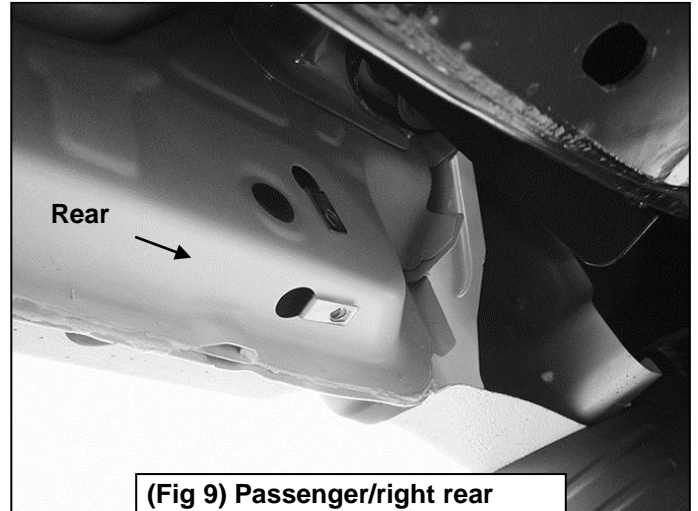

(Fig 9) Passenger/right rear location pictured with Clip Nuts

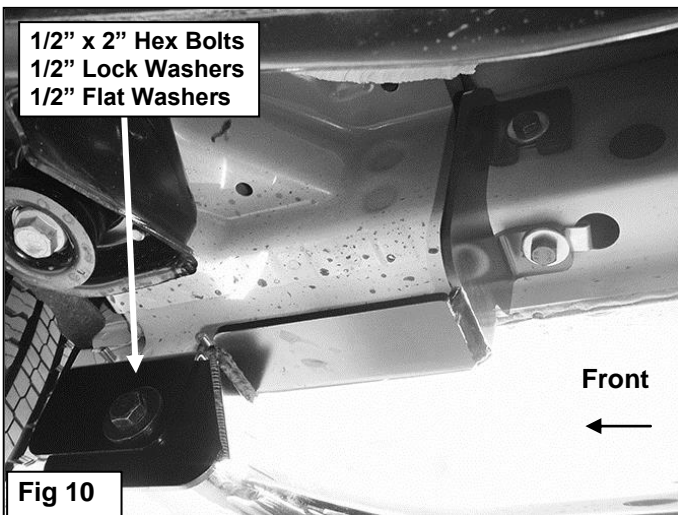
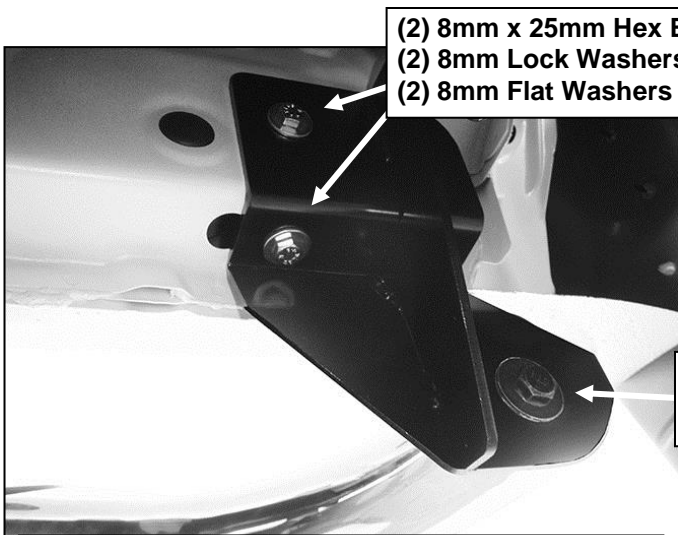

Fig 10



(Fig 12) Passenger/right rear Bracket installation

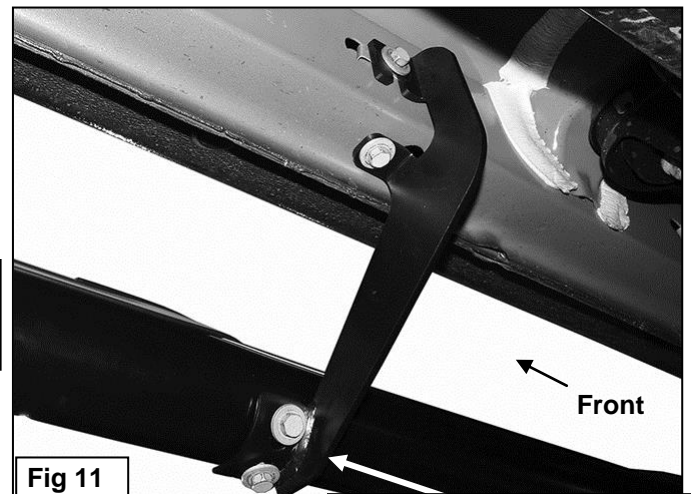

Fig 11

**(2) 8mm x 25mm Hex Bolts
(2) 8mm Lock Washers
(2) 8mm Flat Washers**