

**Before returning this product
to the store of purchase**

Contact Dee Zee if you experience the following problems:

- Missing Parts
- Installation Problems/Questions
- Warranty Questions







Dee Zee Running Board Installation Instructions

Congratulations on your purchase of a quality Dee Zee product. Dee Zee is recognized as having the highest quality running boards and accessories on the market today. We have earned this reputation by offering our customers a product they can be proud to place on their vehicles. Dee Zee meets all the criteria of manufacturing a custom-fit product which guarantees it to be the easiest product to install.

Note: Please take time to read all of the instructions before beginning this installation.

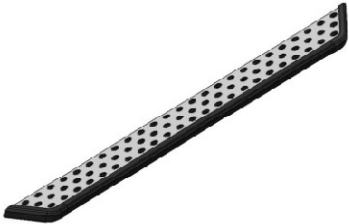
Cleaning instructions: To maintain the bright finish of your Dee Zee running board, clean with a mild detergent and use a high-grade automotive type wax. **DO NOT USE ABRASIVE CLEANERS ON THIS PRODUCT!**

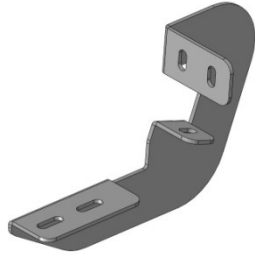
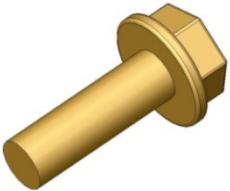
NXt Running Board FORD F150 Pickup

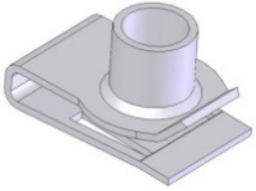
<div style="border: 1px solid black; padding: 2px; display: inline-block;">A</div> <p>NXt Running Board</p>  <p>Various X2</p>	<div style="border: 1px solid black; padding: 2px; display: inline-block;">B</div> <p>Driver Side Bracket</p>  <p>B 1829LP X3</p>	<div style="border: 1px solid black; padding: 2px; display: inline-block;">C</div> <p>Passenger Side Bracket</p>  <p>B 1829RP X3</p>
<div style="border: 1px solid black; padding: 2px; display: inline-block;">D</div> <p>8mm X 25mm Flange Head Bolt</p>  <p>PN 525 X12</p>	<div style="border: 1px solid black; padding: 2px; display: inline-block;">E</div> <p>8mm Hex Flange Nut</p>  <p>PN 526 X12</p>	<div style="border: 1px solid black; padding: 2px; display: inline-block;">F</div> <p>8mm U-nut</p>  <p>PN 909 X12</p>

Tools Required

Ratchet / Wrench
13mm

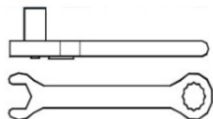

1

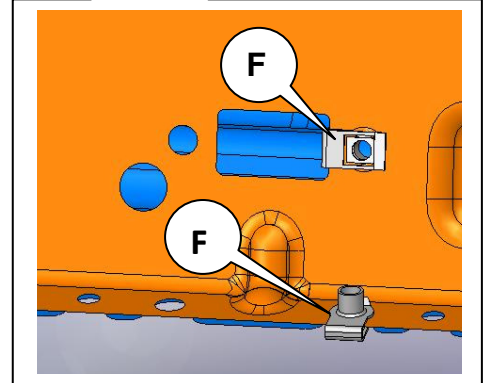
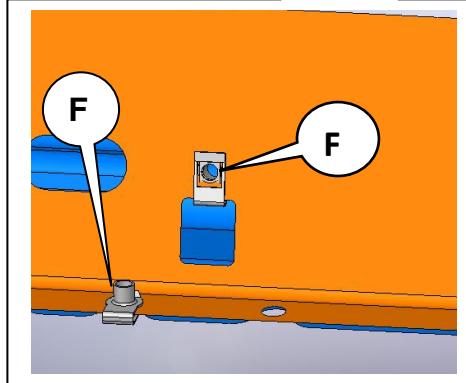
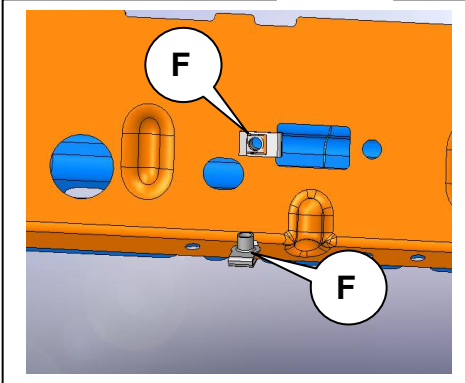
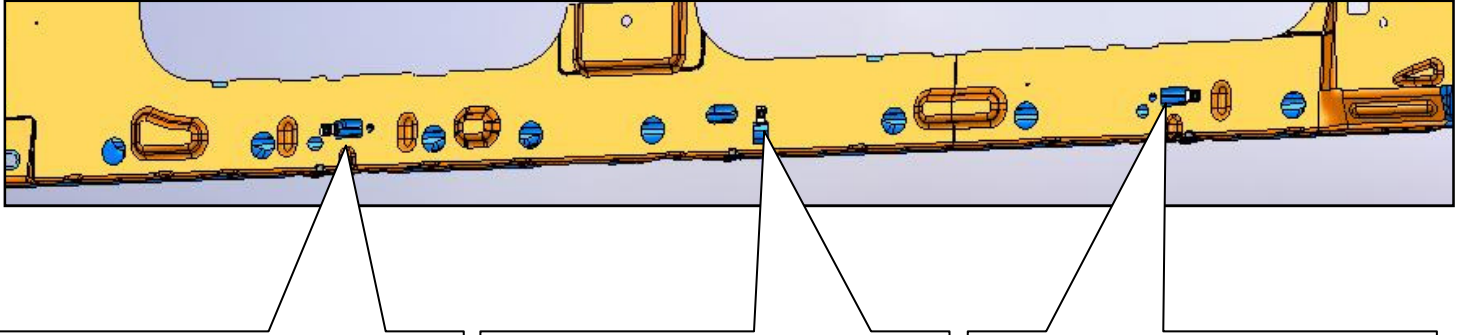

NOTE: FOR STANDARD CAB APPLICATIONS, MIDDLE BRACKET LOCATION IS NOT AVAILABLE. PROCEED AS DIRECTED USING FRONT AND REAR MOUNTING LOCATIONS. EXTRA BRACKETS AND HARDWARE MAY BE DISCARDED.

2

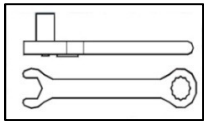
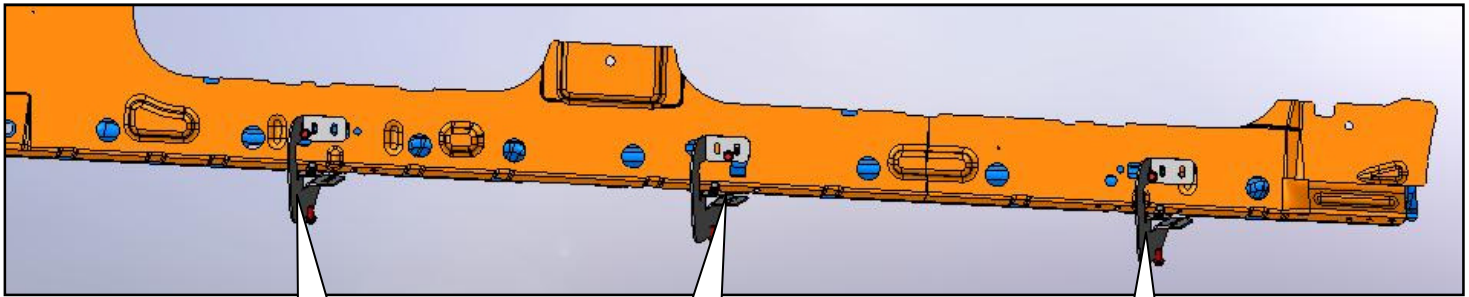

13mm wrench

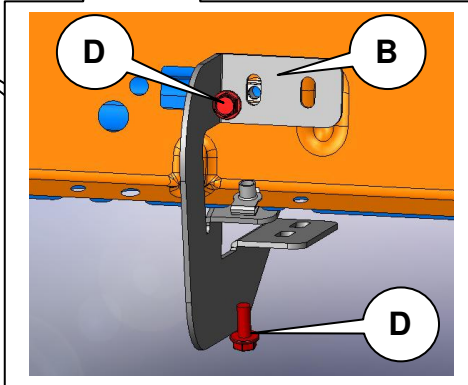
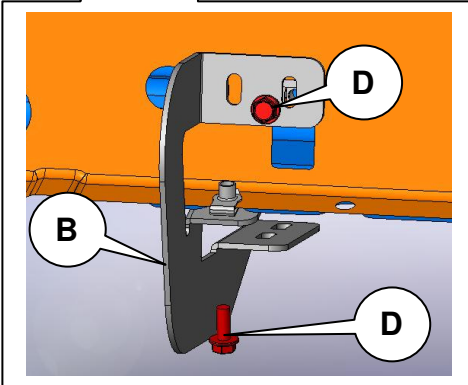
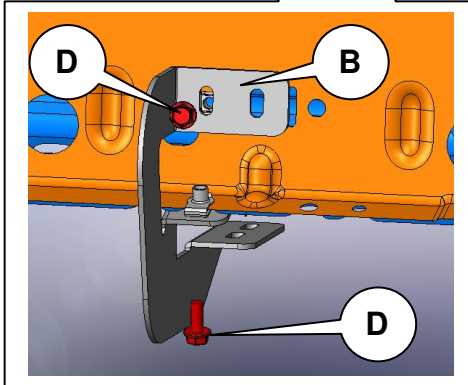

3

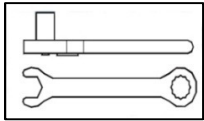
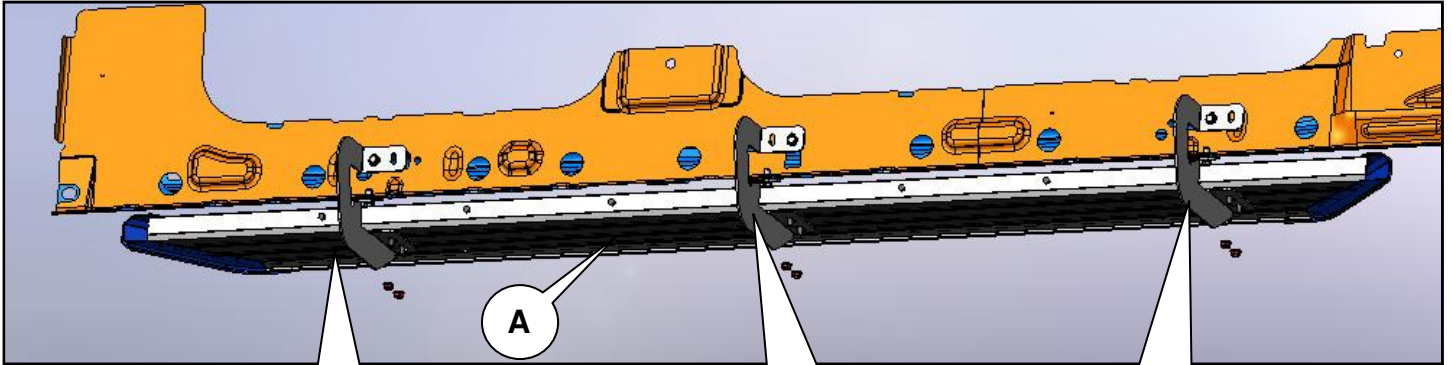

13mm wrench

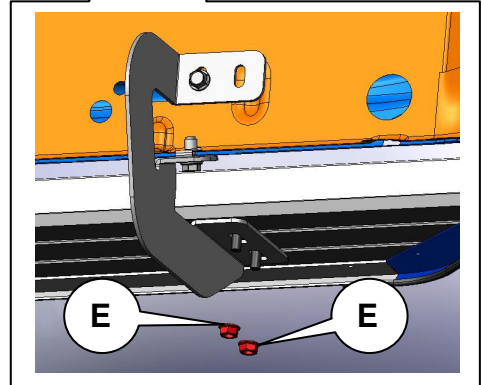
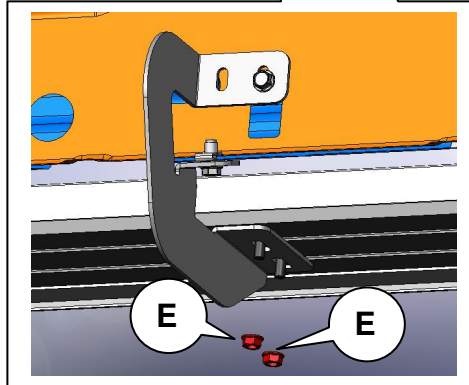
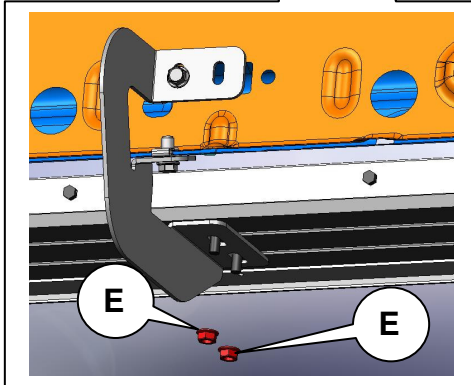

4

REPEAT STEPS 1-3 FOR PASSENGER SIDE USING BRACKET C.