

**Before returning this product  
to the store of purchase**

**Contact Dee Zee if you experience the following problems:**

- Missing Parts
- Installation Problems/Questions
- Warranty Questions



## Dee Zee Running Board Installation Instructions

***Congratulations on your purchase of a quality Dee Zee product. Dee Zee is recognized as having the highest quality running boards and accessories on the market today. We have earned this reputation by offering our customers a product they can be proud to place on their vehicles. Dee Zee meets all the criteria of manufacturing a custom-fit product which guarantees it to be the easiest product to install.***







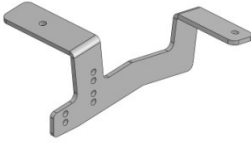
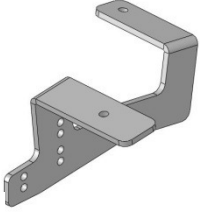
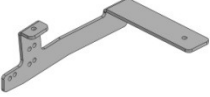
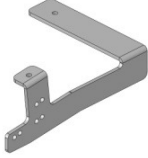
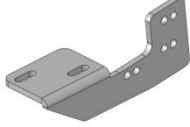

**Note: Please take time to read all of the instructions before beginning this installation.**

**Warning! Please check for wiring or other obstructions before drilling any holes into the vehicle. If it is necessary to drill any holes into the vehicle, Dee Zee recommends putting a sealant or rust inhibitor around all holes drilled into the body of the vehicle.**

**Warning! It is unlawful and dangerous to ride on running boards or side box boards while vehicle is in motion.**

**Cleaning instructions: To maintain the bright finish of your Dee Zee running boards, clean with a mild detergent and use a high grade automotive type wax. DO NOT USE ABRASIVE CLEANERS ON THIS PRODUCT!**

# DZ 16212 CHEVROLET EQUINOX/GMC TERRAIN BRACKET KIT

<p><b>A</b> DZ 16201 / DZ 16202 / DZ 16203 *SOLD SEPARATELY FROM THIS KIT*</p>  <p>BD BRBOARDBB BD BRBOARDBVM BD BRBOARDSSB</p> <p style="text-align: right;">X2</p>	<p><b>B</b> RUNNING BOARD BRACKET</p>  <p>B 1814LP</p> <p style="text-align: right;">X1</p>	<p><b>C</b> RUNNING BOARD BRACKET</p>  <p>B 1814RP</p> <p style="text-align: right;">X1</p>
<p><b>D</b> RUNNING BOARD BRACKET</p>  <p>B 1815LP</p> <p style="text-align: right;">X1</p>	<p><b>E</b> RUNNING BOARD BRACKET</p>  <p>B 1815RP</p> <p style="text-align: right;">X1</p>	<p><b>F</b> RUNNING BOARD BRACKET</p>  <p>B 1816P</p> <p style="text-align: right;">X4</p>
<p><b>G</b> 3/8"-16 X 1.25 HEX CAP SCREW 18-8 SS</p>  <p>PN 440</p> <p style="text-align: right;">X2</p>	<p><b>H</b> M8 X 18 mm SQUARE HEAD BOLT</p>  <p>PN 524</p> <p style="text-align: right;">X8</p>	<p><b>I</b> 3/8-16 LARGE THREAD PLATE</p>  <p>PN 407</p> <p style="text-align: right;">X2</p>
<p><b>J</b> M8 – 1.25 SINGLE TAB WELD NUT</p>  <p>PN 714</p> <p style="text-align: right;">X2</p>	<p><b>K</b> M8 X 25mm HEX HEAD FLANGE BOLT</p>  <p>PN 525</p> <p style="text-align: right;">X8</p>	<p><b>L</b> M8 HEX HEAD FLANGE NUT</p>  <p>PN 526</p> <p style="text-align: right;">X20</p>
<p><b>M</b> M8 – 1.25 DOUBLE TAB WELD NIIT</p>  <p>PN 611</p> <p style="text-align: right;">X4</p>	<p><b>N</b> M8 X 20mm HEX HEAD FLANGE BOLT</p>  <p>PN 527</p> <p style="text-align: right;">X12</p>	

**Tools Required:**



**Tape Measure**

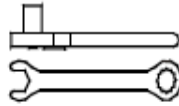

**Ratchet / Wrench**

13mm

9/16"

**Note: Air tools recommended.**

**1**

Place the 8mm square head bolts (H) into the two bolt channels of the running board (A) and slide toward either end of the board. For this application, there should be two bolts in the front channel on opposite ends of the board, and two bolts in the rear channel on opposite ends of the board.

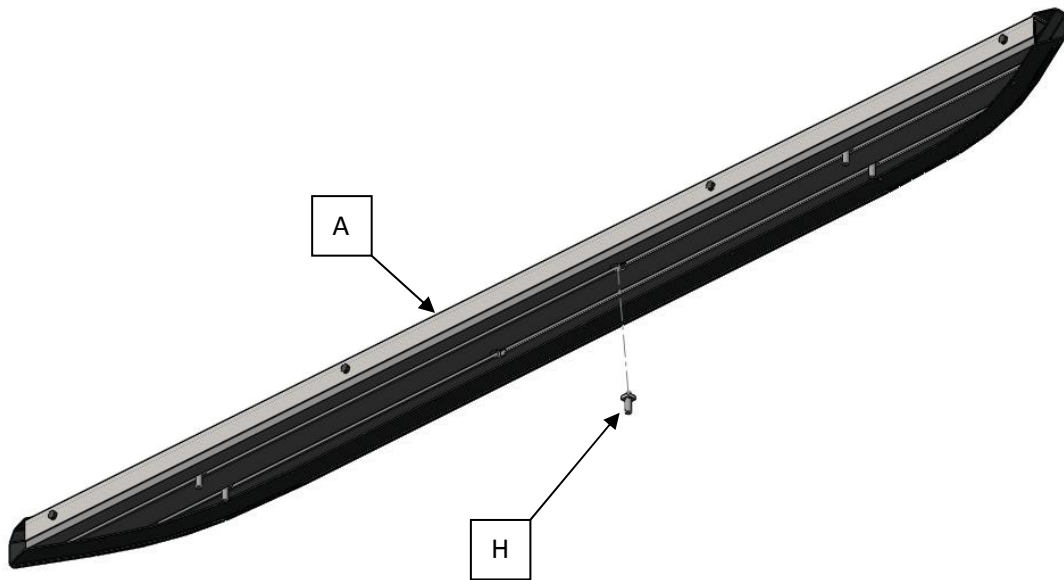

**2**

**Determine the correct bracket alignment per application (To be used in Step 6).**

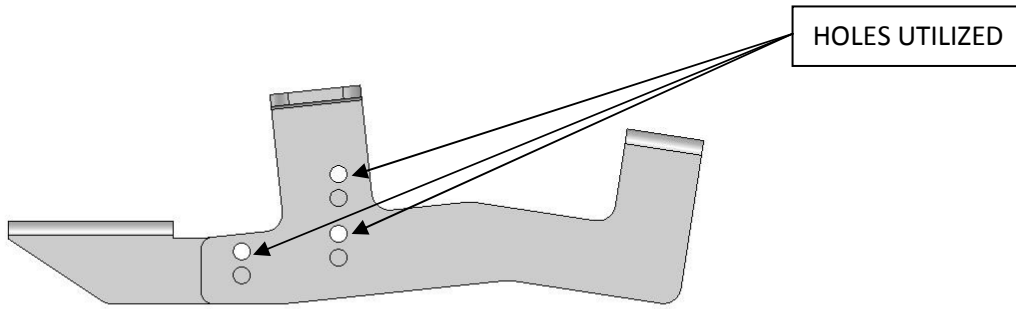

**Front Bracket Equinox – driver**

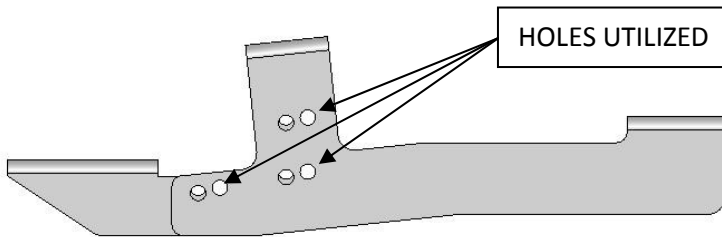

**Rear Bracket Equinox – driver**

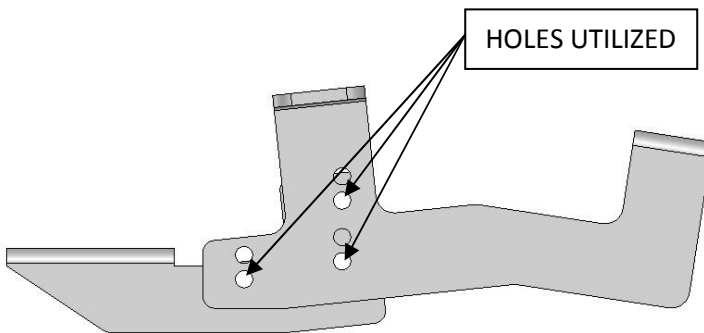

**Front Bracket Terrain – driver**

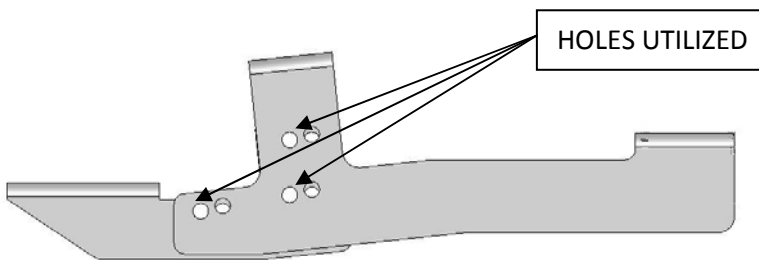

**Rear Bracket Terrain – driver**

---

**3**

Locate the existing hole locations shown below. There will be two sets of hole locations (Front, Rear).



**Front driver**



**Rear driver**

**4**

Place an 8mm x 25mm hex head bolt (K) through running board bracket (B) and start the bolt into a M8 – 1.25 double tab spot weld nut (M) in the front hole location shown below. Place an 8mm x 25mm hex head bolt (K) through running board bracket (B) and start the bolt into a M8 – 1.25 single tab spot weld nut (J) in the rear hole location shown below. Position bracket into front driver location with thread plates in vehicle openings and tighten completely.

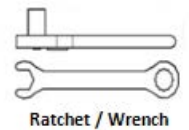
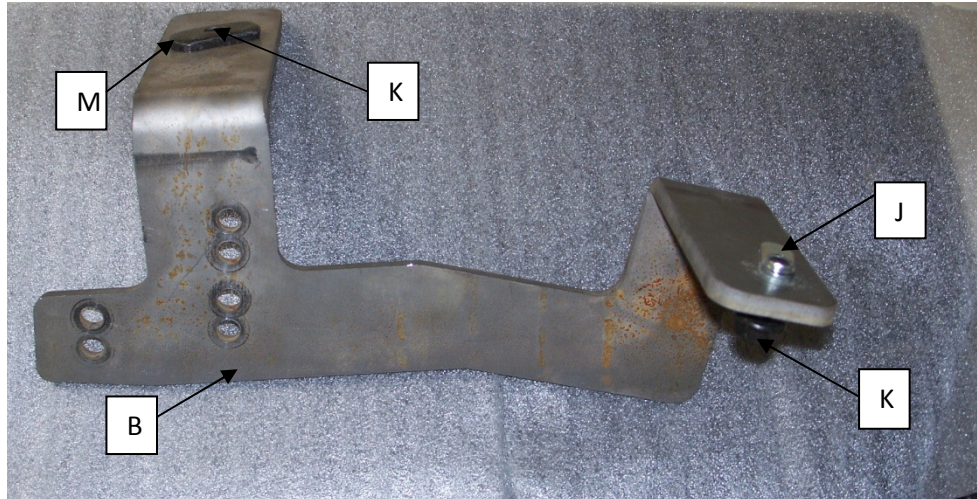

Ratchet / Wrench

13 mm

**5**

Place an 8mm x 25mm hex head bolt (K) through running board bracket (D) and start the bolt into a M8 – 1.25 double tab spot weld nut (M) in the front hole location shown below. Place a 3/8”-16 x 1.25 hex cap screw (G) through running board bracket (D) and start the bolt into a 3/8”-16 large thread plate (I) in the rear hole location shown below. Position bracket into front driver location with thread plates in vehicle openings and tighten completely.

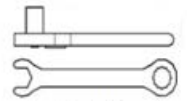
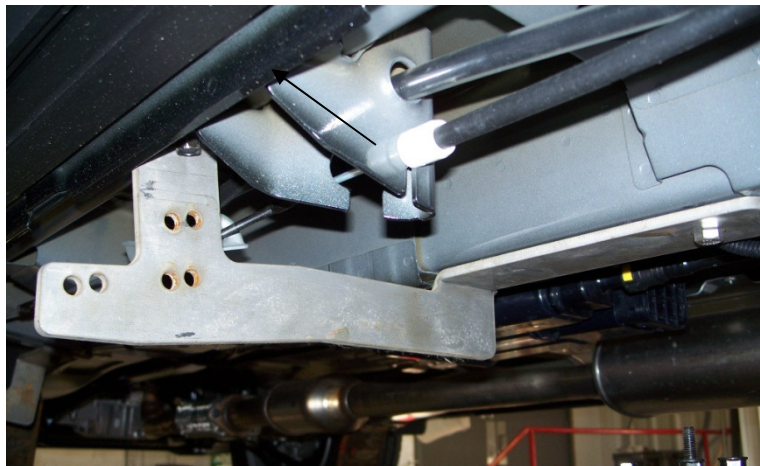
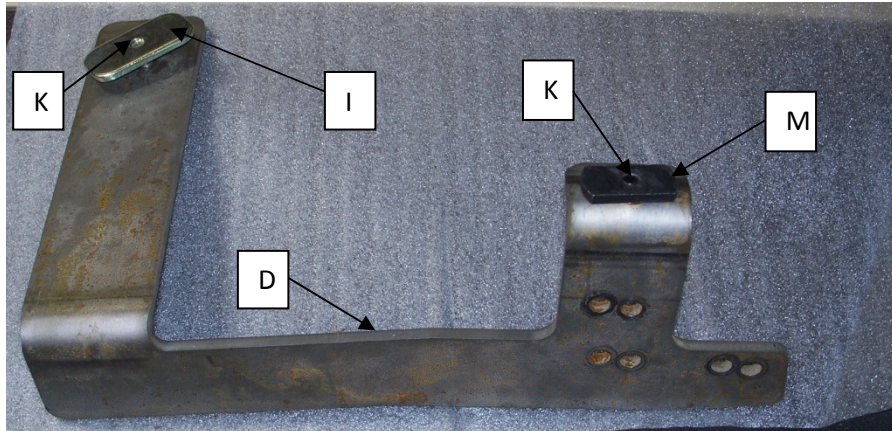

Ratchet / Wrench

13 mm

9/16"



# 6

Using the bracket configuration for the application needed (shown in Step 2), place running board bracket (F) onto the correct location in Bracket (B) and bolt together using a 8mmx20mm hex head flange bolt (N) and a M8 flange nut (L). Repeat for the rear bracket location (brackets D and F), again using the correct location from Step 2. Place running board on bracket (F) and start M8 flange nuts (L) onto each of the 8mm square head bolts (H). Do not completely tighten. Rotate board upwards and then place the remaining two 8mmx20mm hex head flange bolt (N) and the two M8 flange nut (L) (per bracket location) and tighten all completely.

Center board on vehicle between wheel well openings or until desired appearance is aquired. Adjust board in/out on vehicle until desired appearance is met. (Note: opening door may aid in determining step surface location in/out on vehicle) Tighten the M8 nuts (L) completely securing the board to the brackets.

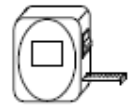
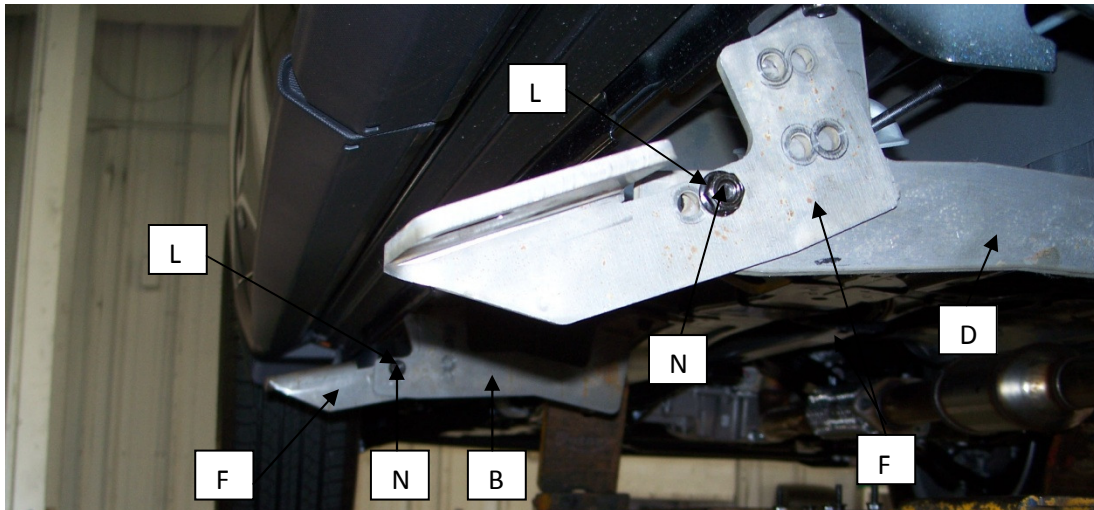

**Tape Measure**

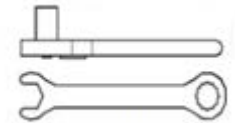

**Ratchet / Wrench**

13 mm

# 7

Repeat steps 1-6 for passenger side using brackets (C) and (E).