



**INSPECT YOUR PRODUCT FOR DAMAGE & MISSING  
PARTS BEFORE PROCEEDING TO INSTALLATION**

**PROCEDURE FOR RETURNS OR MISSING HARDWARE**

-PLEASE CONTACT THE ORIGINAL POINT OF PURCHASE FOR:  
SHIPPING DAMAGE, RETURNS, OR WARRANTY CLAIMS

-CONTACT DEE ZEE DIRECTLY FOR MISSING PARTS OR HARDWARE

---

Operating, servicing, and maintaining a passenger vehicle can expose you to chemicals such as lead, phthalates, engine exhaust, and carbon monoxide that are known to the State of California cause cancer and birth defects or other reproductive harm. To minimize exposure, service your vehicle and its accessories in a well-vented area and wear gloves or wash your hands frequently.



Thank you for choosing Dee Zee to add function and accessorize your vehicle. Dee Zee has been a staple brand in the truck accessory market since 1977 and we hold a reputation of quality manufacturing based in America's Heartland. Our products are born through careful engineering and backed by industry leading warranty programs. We appreciate the opportunity to serve you and your vehicle!

**Review the instruction pages in their entirety to prepare the required tools**

**Warning:** Please check for wiring or other obstructions before drilling any holes in the vehicle. If it is necessary to drill any holes, Dee Zee recommends putting a sealant or rust inhibitory around all holes drilled into the body of the vehicle.



It is the sole responsibility of the vehicle owner to check for tire clearance. It is unlawful and dangerous to ride on any external vehicle step while the vehicle is in motion.

**Cleaning:** To be entitled to all warranty rights offered with the product, Dee Zee steps need to be cleaned regularly with a mild detergent. Do NOT use abrasive cleaners. For stainless steel products, the application of a high grade automotive wax is recommended.

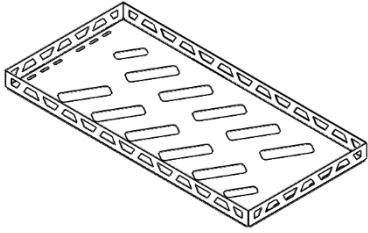
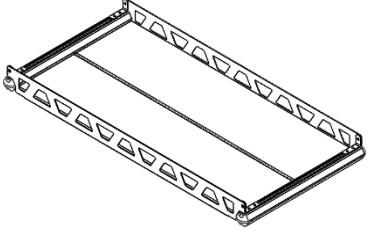
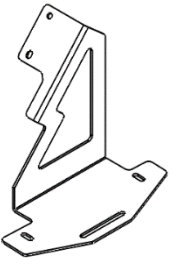
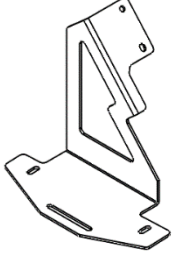
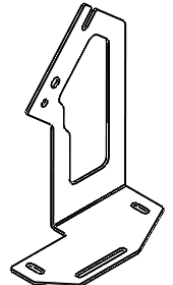
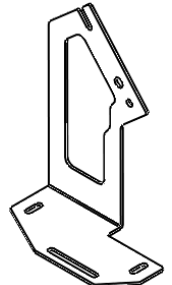
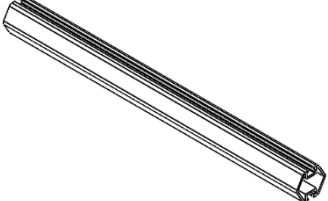
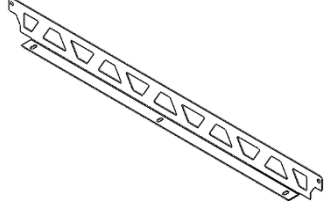
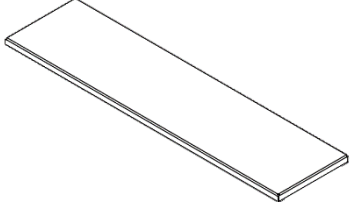
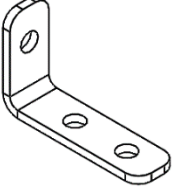

Dee Zee Cares - Please Recycle

**Jeep Cargo Rack Installation Instructions**  
**DZ 4468JK Jeep Wrangler JK 2007-2018, DZ 4468JL Jeep Wrangler JL 2019-Current**  
**DZ 4470JP Steel Cargo Rack, DZ 4471JP Bolt Together Cargo Rack**

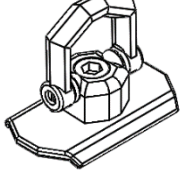
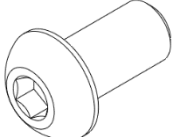
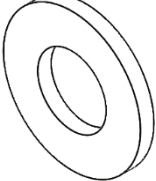
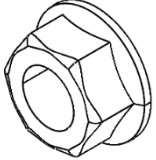
<p><b>A</b> Steel Cargo Rack</p>  <p>DZ 4470JP X1</p>	<p><b>B</b> Bolt Together Cargo Rack</p>  <p>DZ 4471JP X1</p>	<p><b>C</b> JK Driver Mounting Bracket</p> <p>Only used on JK</p>  <p>B 2689LP X1</p>
<p><b>D</b> JK Passenger Mounting Bracket</p> <p>Only used on JK</p>  <p>B 2689RP X1</p>	<p><b>E</b> JL Driver Mounting Bracket</p> <p>Only used on JL</p>  <p>B 2690LP X1</p>	<p><b>F</b> JL Passenger Mounting Bracket</p> <p>Only used on JL</p>  <p>B 2690RP X1</p>
<p><b>G</b> 20" Hex Tube</p>  <p>JPCR004P DZ 4471JP X2</p>	<p><b>H</b> Rack Fence</p>  <p>JPCR003P DZ 4471JP X2</p>	<p><b>I</b> Rack Deck</p>  <p>JPCR002P DZ 4471JP X2</p>
<p><b>J</b> L Bracket</p>  <p>B 2523P DZ 4471JP X4</p>	<p><b>K</b> Small Hex Endcap</p>  <p>EC DZE-581ASSM DZ 4471JP X4</p>	<p><b>L</b> Hex Series Tie Downs</p>  <p>DZ 99700TB DZ 4471JP X2</p>
<p><b>M</b> M8-1.25X16mm Button Head Bolt</p>  <p>PN 1261  DZ 4470JP X4  DZ 4471JP X14  DZ 4468JL X4</p>	<p><b>N</b> M8 Washer</p>  <p>PN 647B  DZ 4470JP X4  DZ 4471JP X14  DZ 4468JL X4</p>	<p><b>O</b> M8 Hex Flange Nut</p>  <p>PN 526  DZ 4470JP X4  DZ 4471JP X14</p>

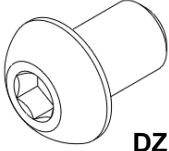
**P****M8-1.25X12mm Button Head Bolt**

PN 1260

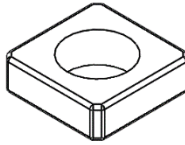
DZ 4470JP X4  
DZ 4471JP X12**Q****M8 Square Nut**

PN 1262

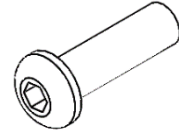
DZ 4470JP X4  
DZ 4471JP X12**R****M6-1.0X20mm Button Head Bolt**

PN 649B

DZ 4468JK X4

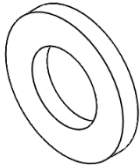
**S****M6 Washer**

PN 645B

DZ 4468JK X4

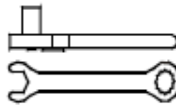
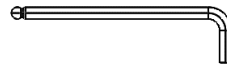
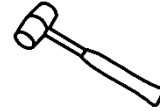
**Required Tools**Wrench  
13mmAllen Wrench  
4mm  
5mm  
6mm

Rubber Mallet

Straight Blade  
Screwdriver**1**

This step is for JK only, If you have a JL skip to step 3. First undo the Hook and loop fastener on the roll cage cover on the drivers side in the cargo area shown below to find the threaded holes.

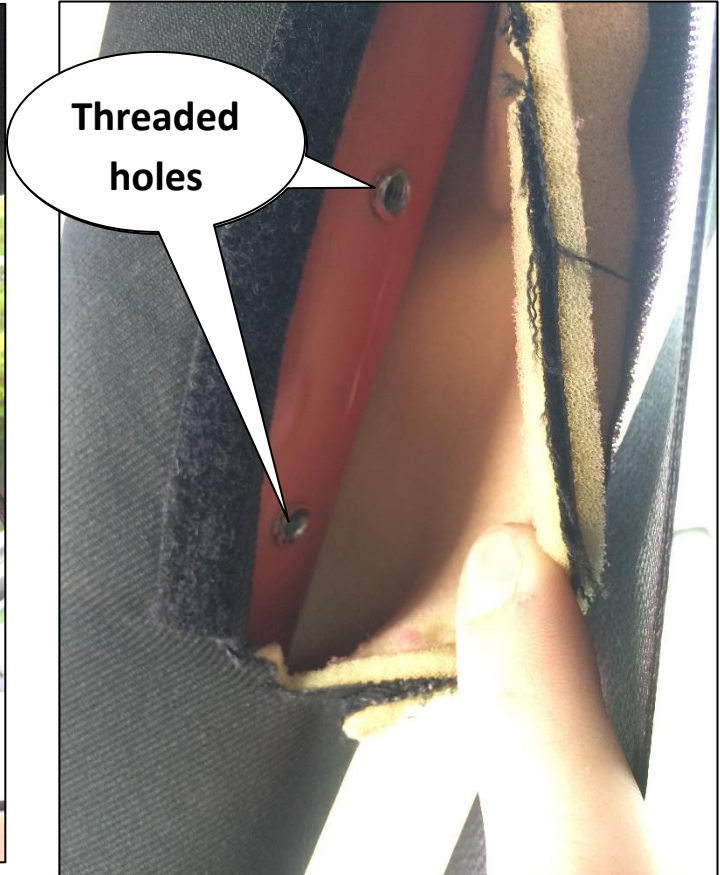



**2** Install bracket (C) using bolts (R) and washers (S) into the threaded holes found in the previous step. Repeat steps 1&2 on the passenger side using bracket (D) instead.

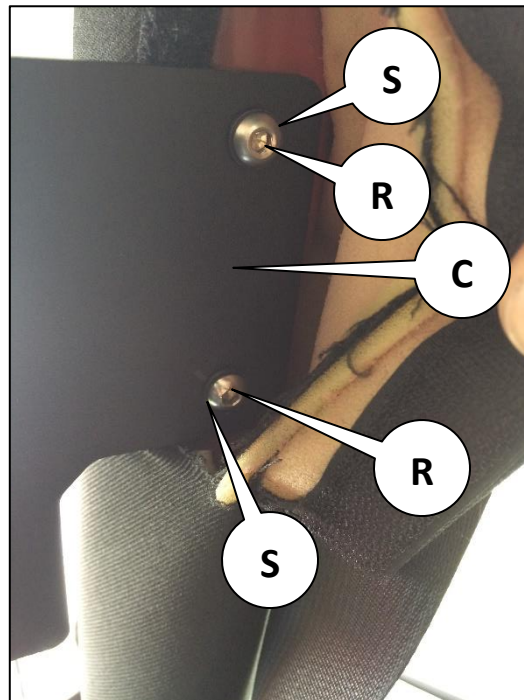
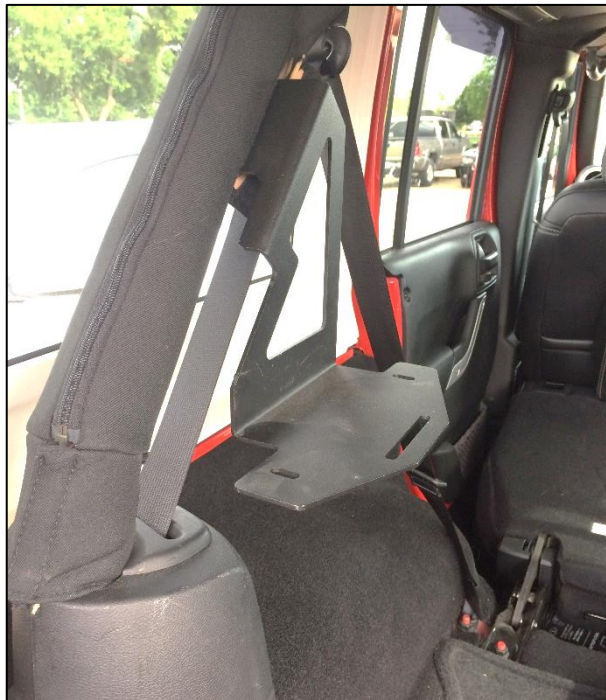

**3** This step is for JL only, if you have a JK skip to step 5. Remove the plastic cover using the screwdriver on the driver side in the cargo area shown below to find the threaded holes.

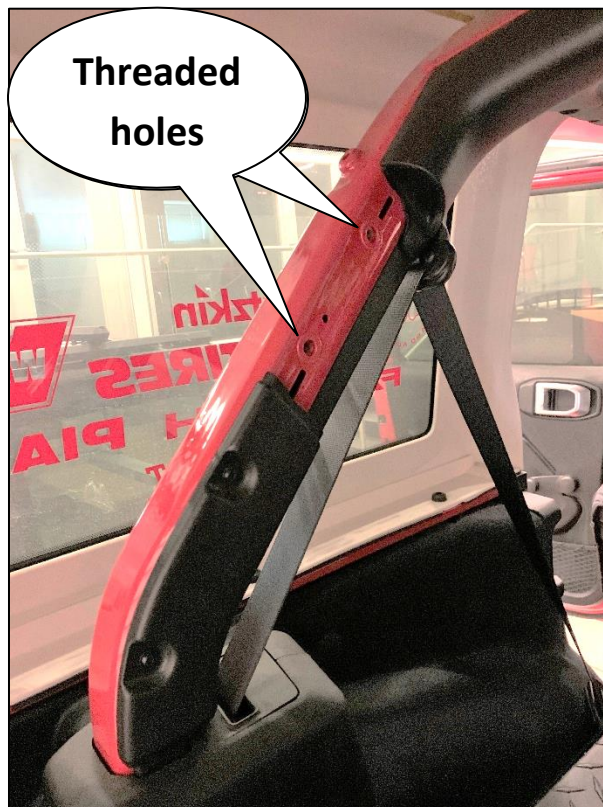

- 4** Install bracket (E) using bolts (M) and washers (N) into the threaded holes found in the previous step. Repeat steps 3&4 on the passenger side using bracket (F) instead.

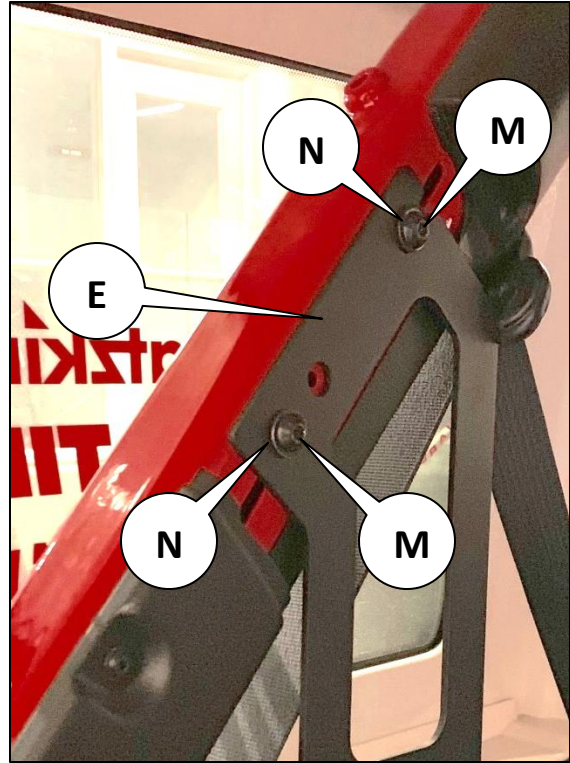

- 5** This step is for DZ 4470JP Steel Rack (A) only, if you have a DZ 4471JP Bolt Together Rack skip to step 6. Place steel rack onto brackets and use bolts (M), washers (N), and nuts (O), to install rack to brackets. Center the rack and tighten all hardware. Discard any extra hardware.

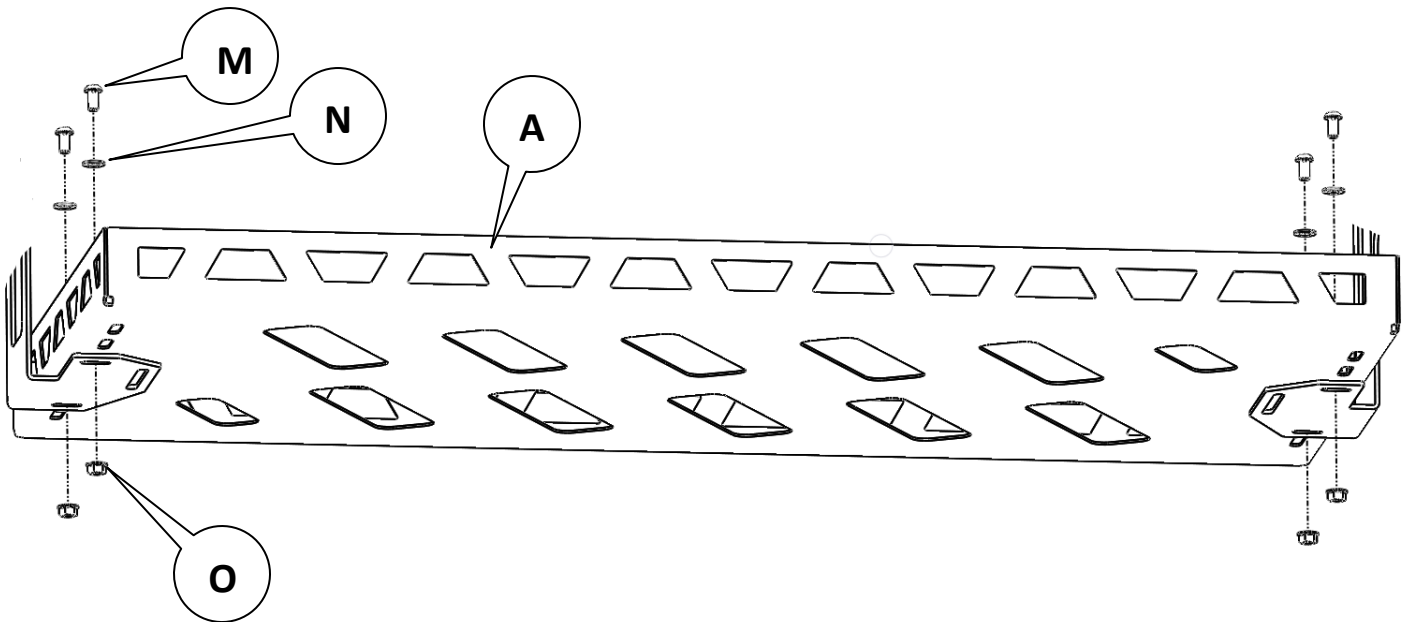



6

The rest of these instructions are for the DZ 4471JP Bolt Together Rack (B). First install bolts (P) and nuts (Q) into the slots of the brackets as shown below. Do not fully tighten at this time.

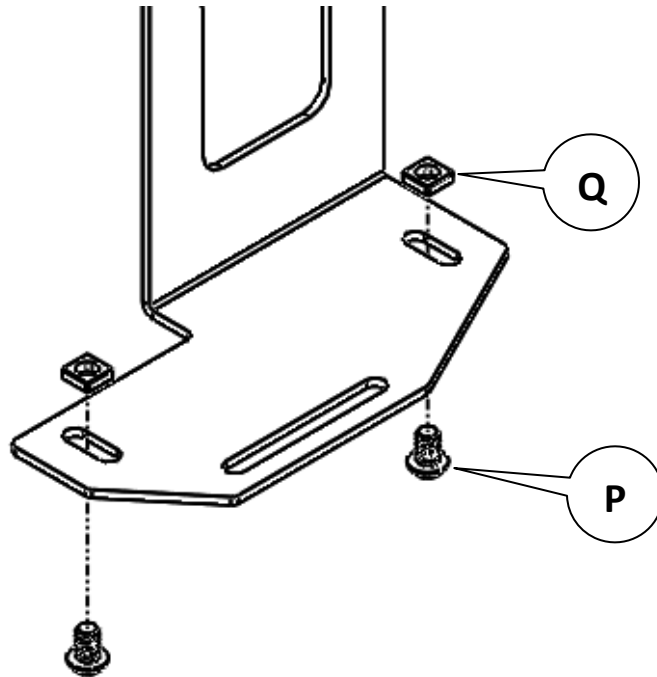

7

Install all endcaps (K) on the hex rails (G) by first hand pushing them to set in place, then hitting them with a rubber mallet.

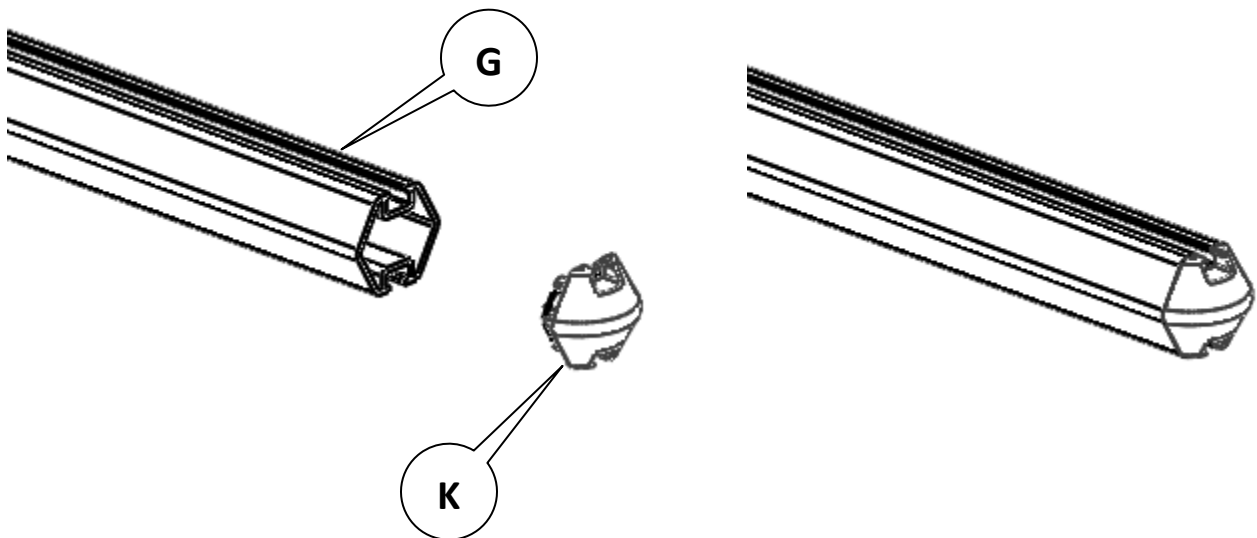

**8**

Slide the hex rails into the nuts from step 6.

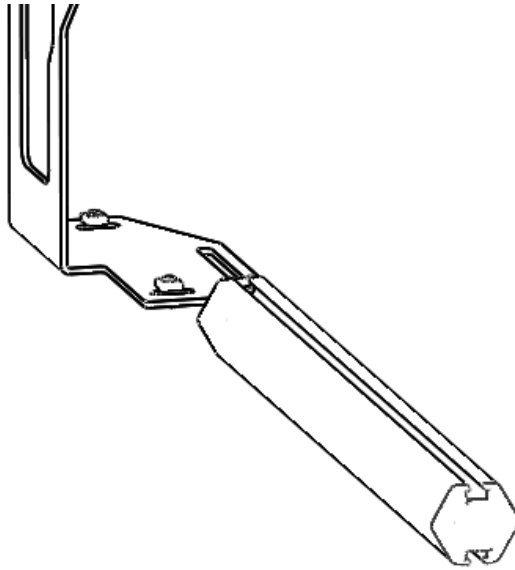

**9**

This Step is Optional. If you want tie downs, slide the tie down (L) onto the top side of the hex rails.

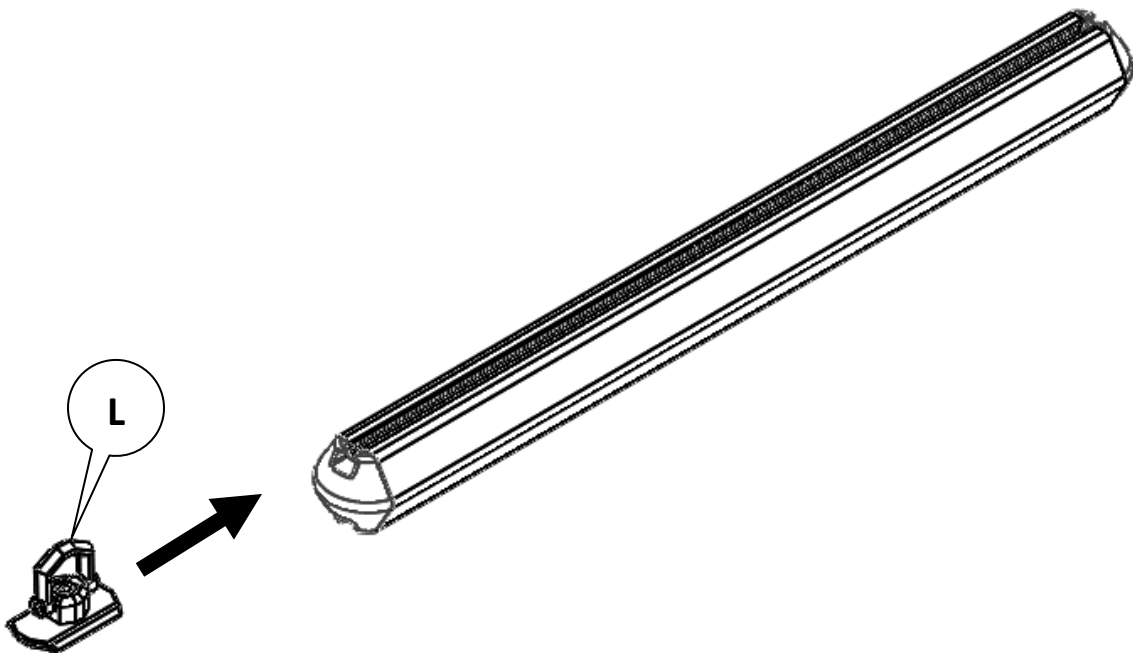



- 10** Preassemble the rack fences (H) using L-brackets (J), bolts (M&P), washers (N), and nuts (O&Q) shown below. Do not fully tighten at this time.

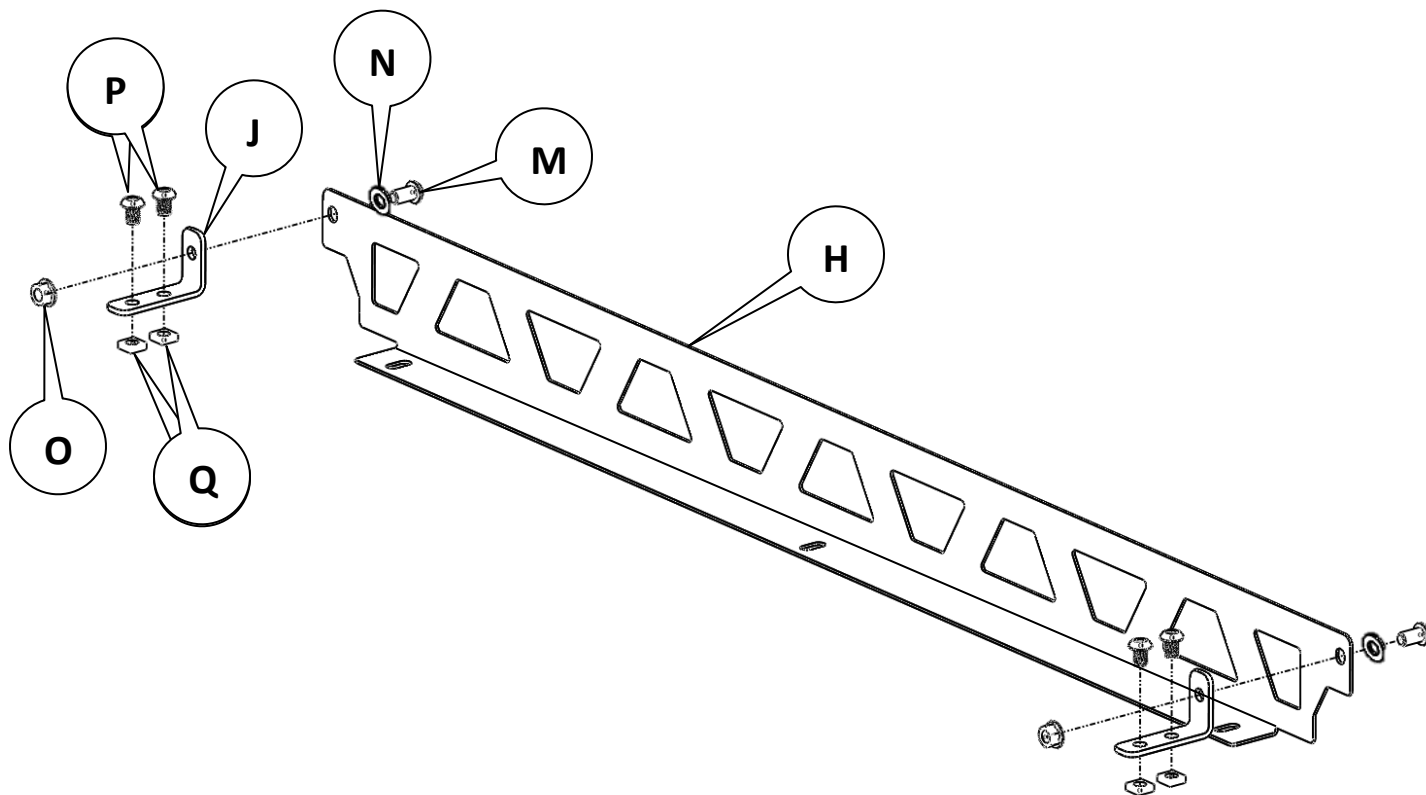

- 11** Slide the preassembled fences into the hex rails with the bends of the fences facing each other. The lower picture below is a side view of about where the fences and hex rails should be on the brackets.

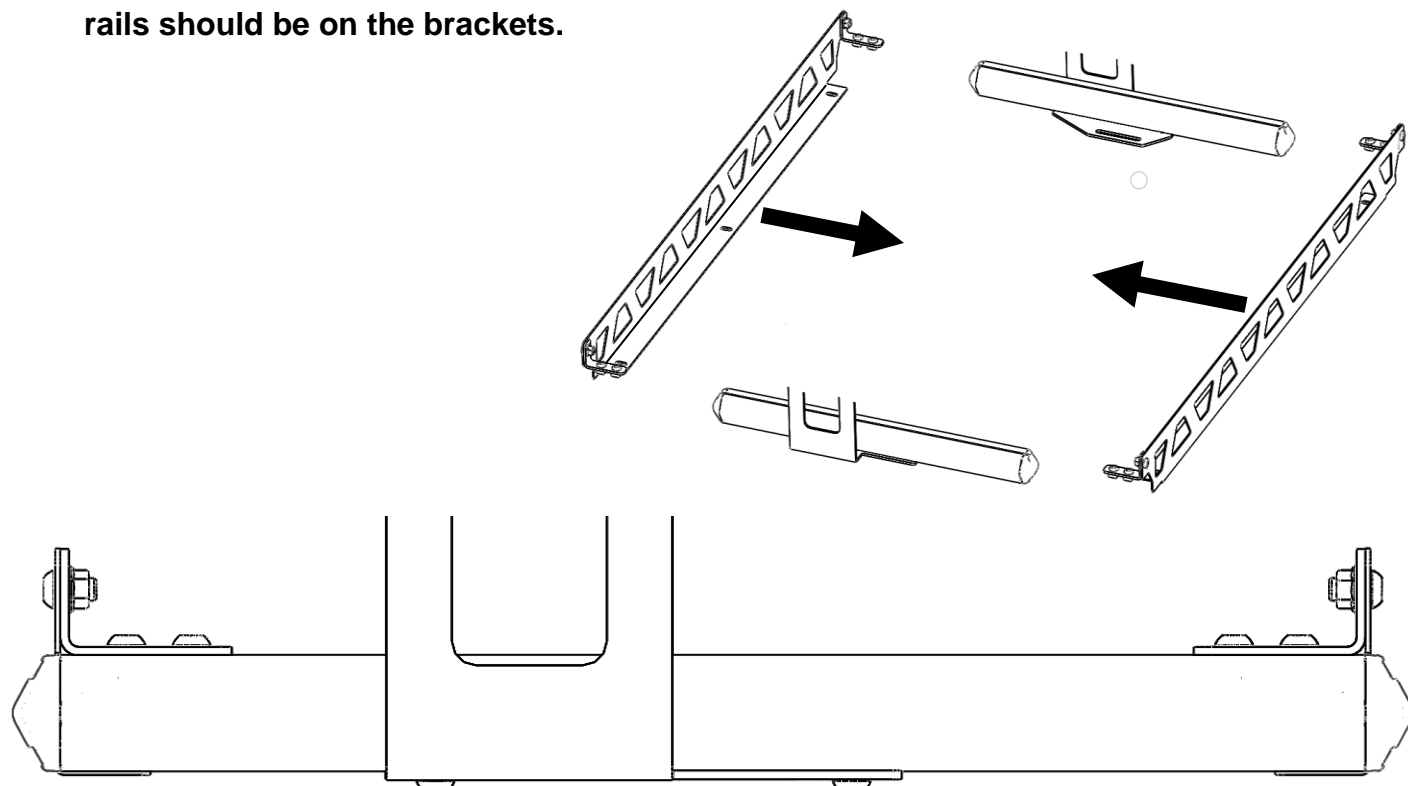

**12**

Drop in the decks (I) between the fences. If desired, one deck can be used instead of two. Ensure decks line up with slots in vehicle brackets and install bolts (M), washers (N), and nuts (O) into fences and through vehicle brackets to install. Center the rack and fully tighten all hardware at this time.

