



**INSPECT YOUR PRODUCT FOR DAMAGE & MISSING
PARTS BEFORE PROCEEDING TO INSTALLATION**

PROCEDURE FOR RETURNS OR MISSING HARDWARE

-PLEASE CONTACT THE ORIGINAL POINT OF PURCHASE FOR:
SHIPPING DAMAGE, RETURNS, OR WARRANTY CLAIMS

-CONTACT DEE ZEE DIRECTLY FOR MISSING PARTS OR HARDWARE

⚠️ WARNING: Cancer and Reproductive Harm

Operating, servicing, and maintaining a passenger vehicle can expose you to chemicals such as lead, phthalates, engine exhaust, and carbon monoxide that are known to the State of California cause cancer and birth defects or other reproductive harm. To minimize exposure, service your vehicle and its accessories in a well-vented area and wear gloves or wash your hands frequently.



Thank you for choosing Dee Zee to add function and accessorize your vehicle. Dee Zee has been a staple brand in the truck accessory market since 1977 and we hold a reputation of quality manufacturing based in America's Heartland. Our products are born through careful engineering and backed by industry leading warranty programs. We appreciate the opportunity to serve you and your vehicle!

Review the instruction pages in their entirety to prepare the required tools

Warning: Please check for wiring or other obstructions before drilling any holes in the vehicle. If it is necessary to drill any holes, Dee Zee recommends putting a sealant or rust inhibitory around all holes drilled into the body of the vehicle.

It is the sole responsibility of the vehicle owner to check for tire clearance. It is unlawful and dangerous to ride on any external vehicle step while the vehicle is in motion.







Cleaning: To be entitled to all warranty rights offered with the product, Dee Zee steps need to be cleaned regularly with a mild detergent. Do NOT use abrasive cleaners. For stainless steel products, the application of a high grade automotive wax is recommended.

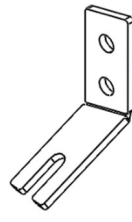
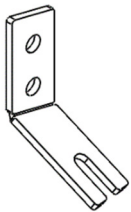
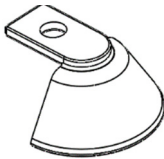

Dee Zee Cares - Please Recycle

JL A-Pillar Light Bracket Installation Instructions

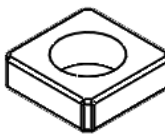
DZ 4446JL Jeep Wrangler JL 2019-Current

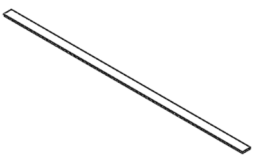
<p>A Driver A-Pillar Bracket</p>  <p>B 2606LWP X1</p>	<p>B Passenger A-Pillar Bracket</p>  <p>B 2606RWP X1</p>	<p>C Accessory Mount Bracket</p>  <p>B 2603LP X1</p>	
<p>D Accessory Mount Bracket</p>  <p>B 2603RP X1</p>	<p>E Bolt-On Half Hex Endcap</p>  <p>EC DZE-620 X2</p>	<p>F M8 X 16mm Button Head Bolt</p>  <p>PN 1261 X8</p>	
<p>G M8 X 12mm Button Head Bolt</p>  <p>PN 1260 X6</p>	<p>H M8 Square Nut</p>  <p>PN 1262 X6</p>	<p>I M8 Hex Flange Nut</p>  <p>PN 526 X8</p>	
<p>J Alcohol Pad</p>  <p>ALPAD X2</p>	<p>K 3M Double Sided Tape</p>  <p>TAPE-25 X2</p>	<p>TO INSTALL THIS BRACKET KIT YOU MUST HAVE BRACKET KIT DZ 4445JL PREVIOUSLY INSTALLED ON THE JEEP.</p>	

Required tools



Ratchet / Wrench
13mm

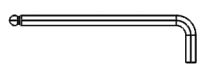

Allen Wrench
5mm



Tape Measure

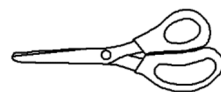

Scissors

1 First cut the two pieces of double sided tape (K) in half making 4 pieces total

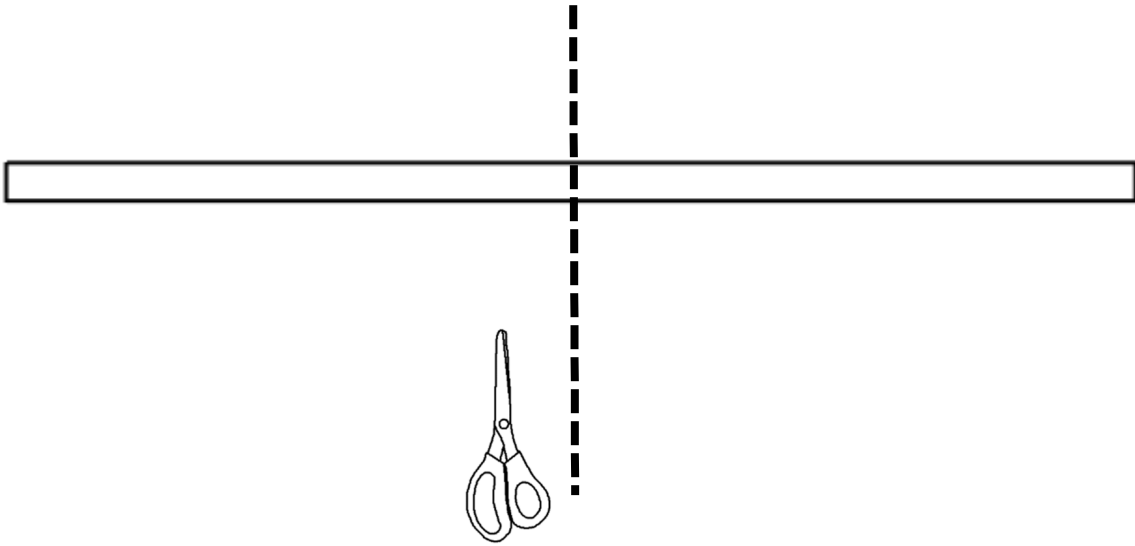

2 Measure from the top of the driver bracket (A) 6 inches down and use an alcohol pad (J) to clean off the next 6 inches of the inside surface of the bracket on each side. Then peel off one side to the tape and apply it 6 inches down from the top of the bracket as shown. Repeat on passenger bracket (B) using the same alcohol pad.

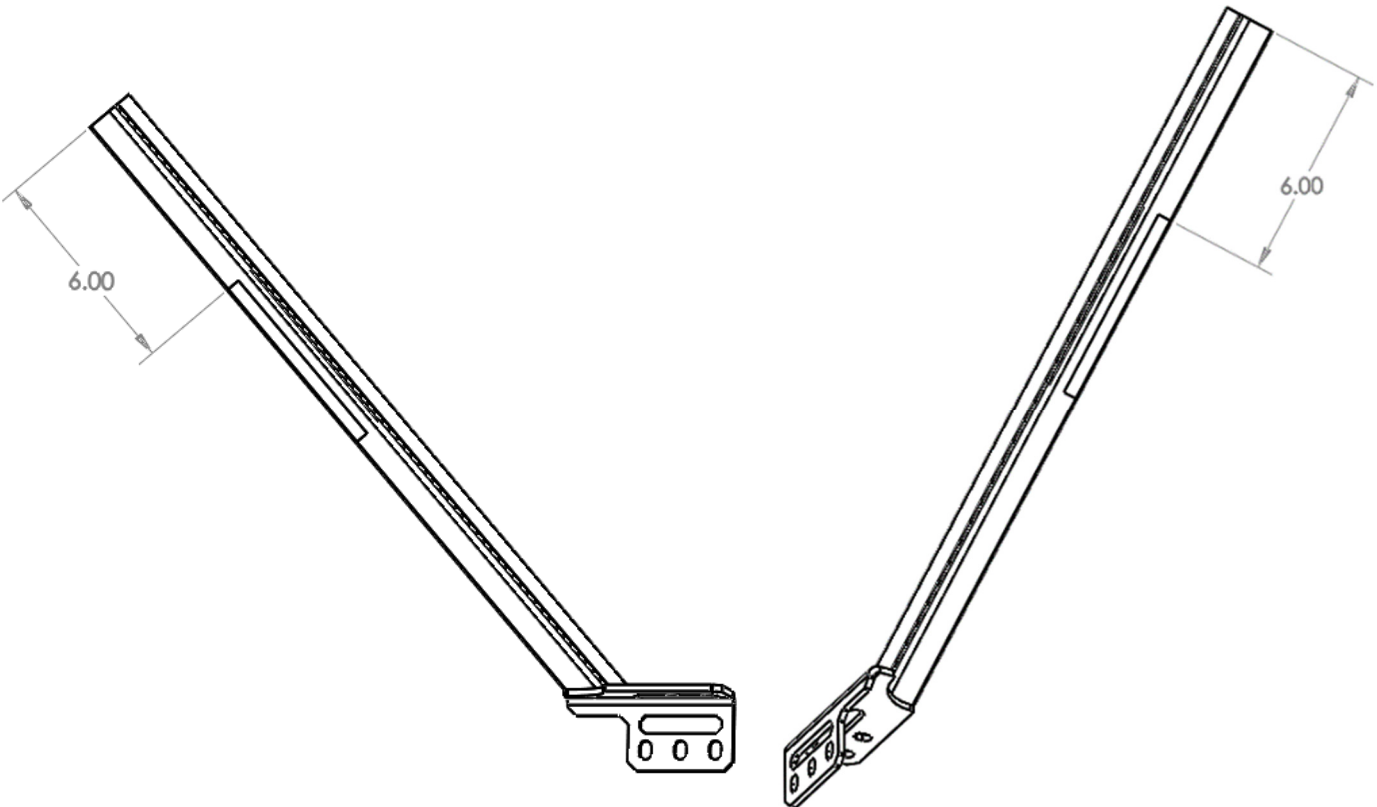

3

Peel up one corner of the double sided tape to the outside of the bracket. Then use alcohol pad (J) to clean off the A-pillar on the jeep in the area shown in the picture below. Repeat this step with the passenger bracket and the passenger side A-pillar.



4

Set driver bracket on the previous installed cowl bracket to see what slots will be used. Install bolts (F), and nuts (I) through the slots of the driver side bracket cowl bracket and the driver A-pillar bracket. Make sure the backing of the double sided tape is showing before tightening the bolts.

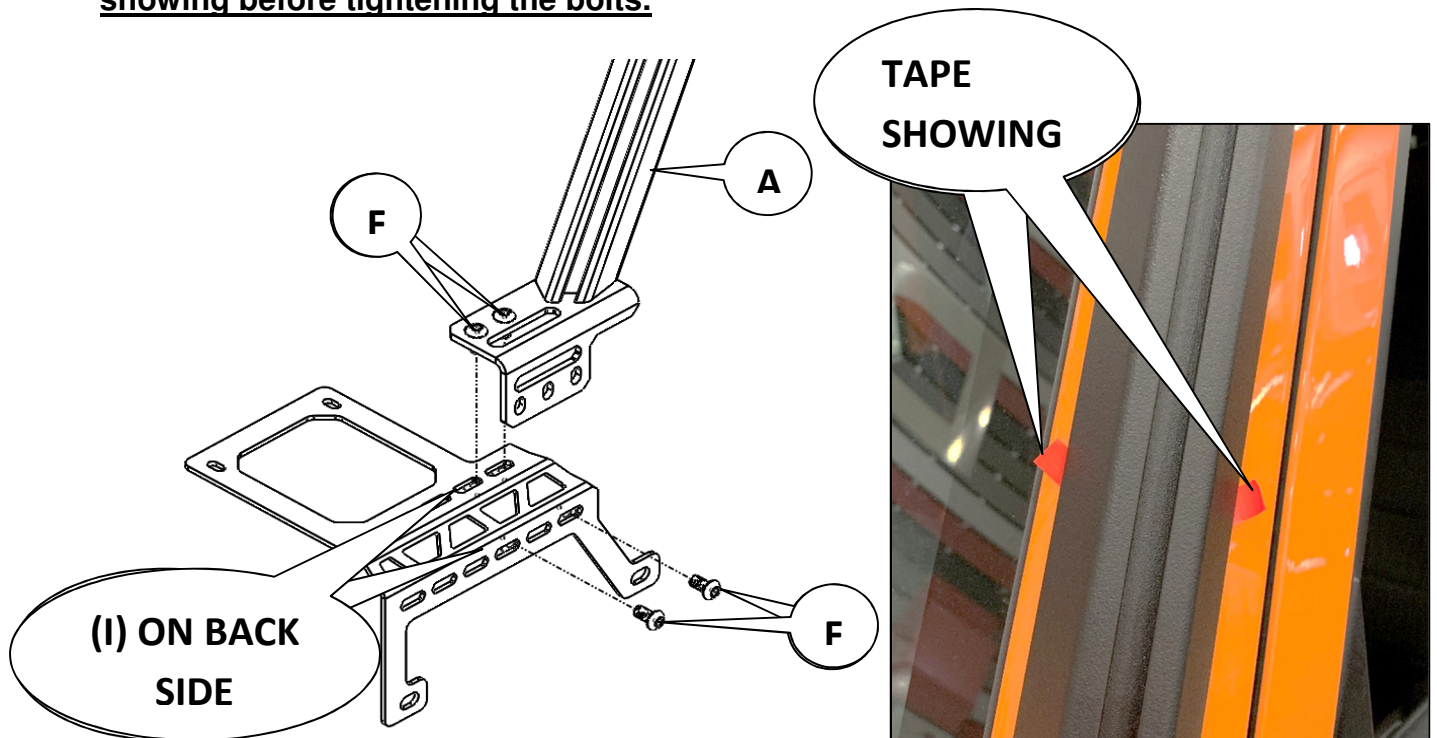

5 Remove the backing of the tape and push the bracket against the vehicle.

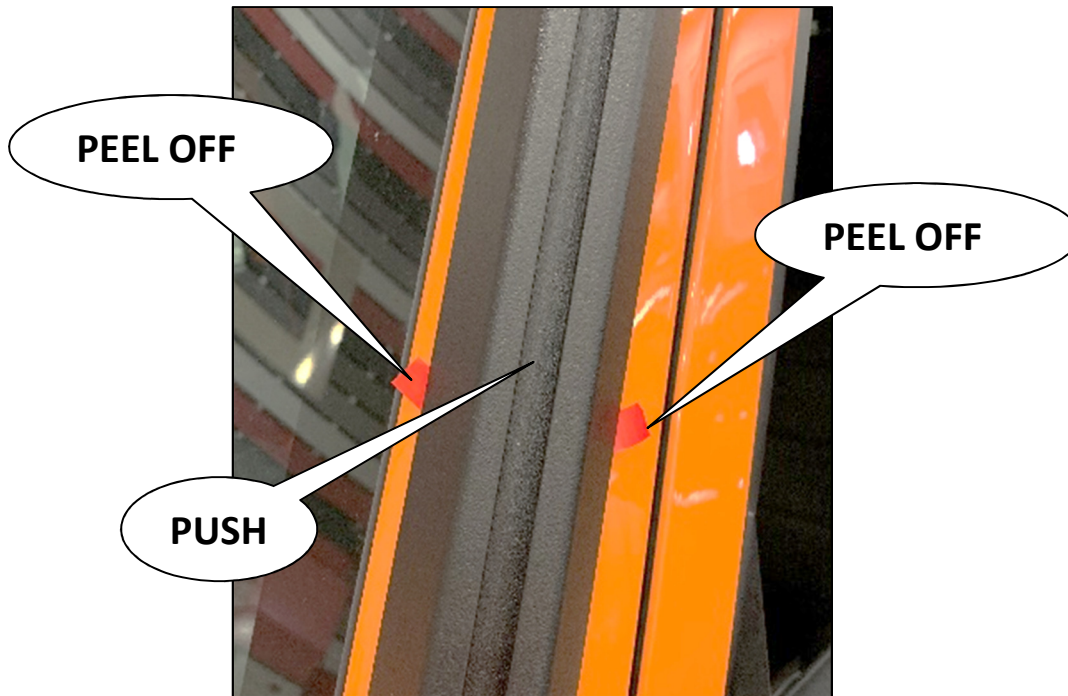

6 Mounting the accessory mount bracket (C) is optional. If you want to mount the accessory mount bracket install bolt (G) through the bracket and put a nut (H) on the back side and slide the bracket in the channel and locate the desired position. Fully tighten bracket.

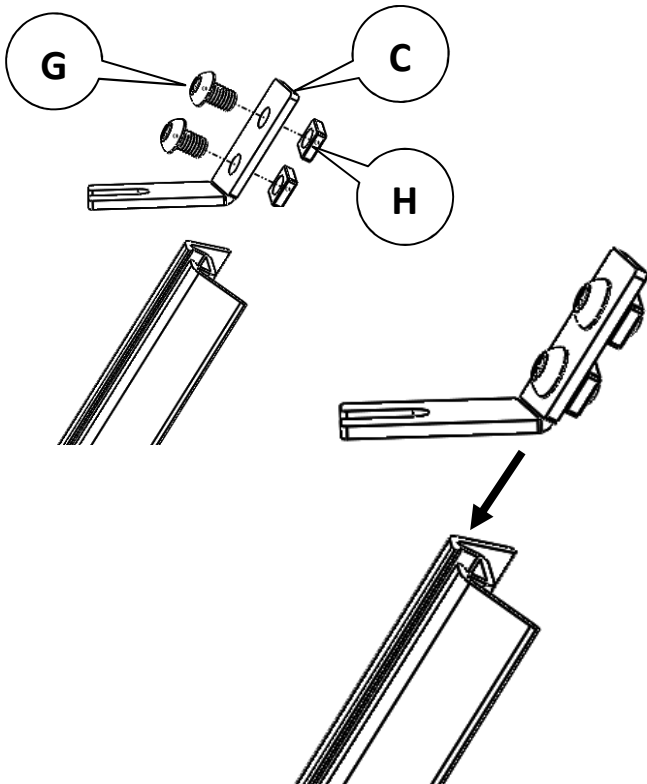

When A-Pillar bracket is mounted the windshield will not be able to be folded down. Brackets C and D are not intended for a Light Bar.

7

Install bolt (G) through the endcap (E) and install nut (H) on the other side. Slide nut into channel until the endcap is flush with the top of the bracket and fully tighten hardware.

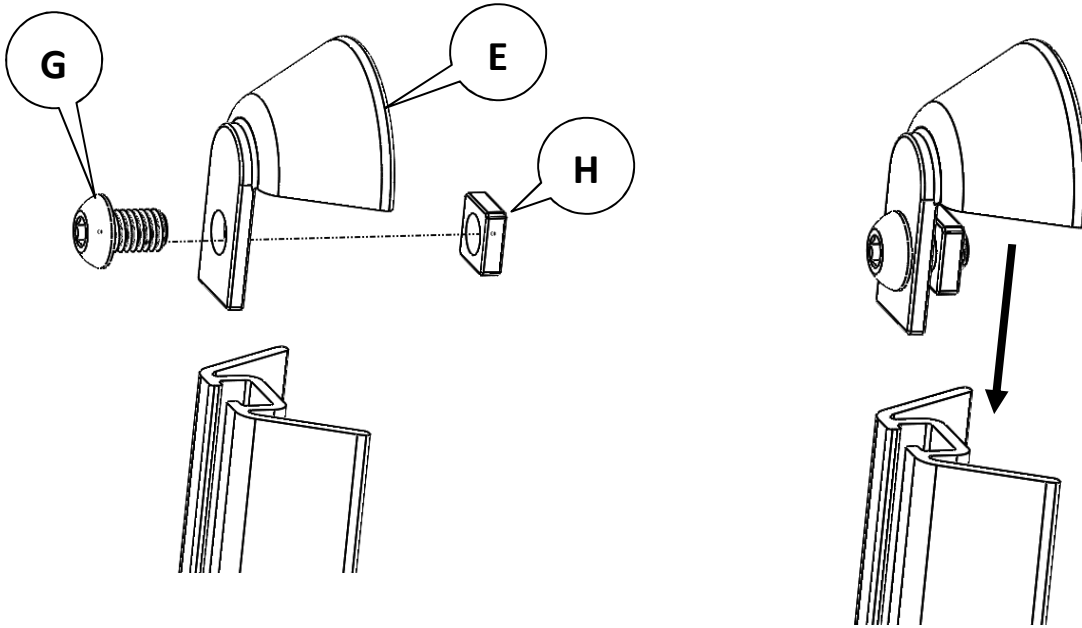

Repeat Steps 4-7 on Passenger side Using bracket B instead of A.

[View other off-road lights made by Dee Zee on our website.](#)