



**INSPECT YOUR PRODUCT FOR DAMAGE & MISSING
PARTS BEFORE PROCEEDING TO INSTALLATION**

PROCEDURE FOR RETURNS OR MISSING HARDWARE

-PLEASE CONTACT THE ORIGINAL POINT OF PURCHASE FOR:
SHIPPING DAMAGE, RETURNS, OR WARRANTY CLAIMS

-CONTACT DEE ZEE DIRECTLY FOR MISSING PARTS OR HARDWARE

Operating, servicing, and maintaining a passenger vehicle can expose you to chemicals such as lead, phthalates, engine exhaust, and carbon monoxide that are known to the State of California cause cancer and birth defects or other reproductive harm. To minimize exposure, service your vehicle and its accessories in a well-vented area and wear gloves or wash your hands frequently.



Thank you for choosing Dee Zee to add function and accessorize your vehicle. Dee Zee has been a staple brand in the truck accessory market since 1977 and we hold a reputation of quality manufacturing based in America's Heartland. Our products are born through careful engineering and backed by industry leading warranty programs. We appreciate the opportunity to serve you and your vehicle!

Review the instruction pages in their entirety to prepare the required tools

Warning: Please check for wiring or other obstructions before drilling any holes in the vehicle. If it is necessary to drill any holes, Dee Zee recommends putting a sealant or rust inhibitory around all holes drilled into the body of the vehicle.

It is the sole responsibility of the vehicle owner to check for tire clearance. It is unlawful and dangerous to ride on any external vehicle step while the vehicle is in motion.





Cleaning: To be entitled to all warranty rights offered with the product, Dee Zee steps need to be cleaned regularly with a mild detergent. Do NOT use abrasive cleaners. For stainless steel products, the application of a high grade automotive wax is recommended.

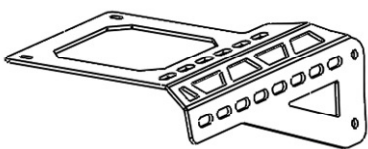
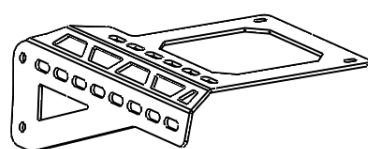
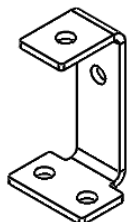
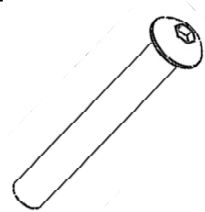
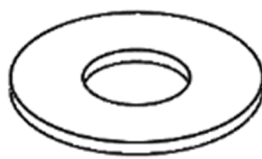
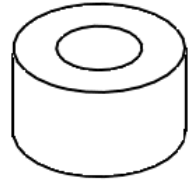
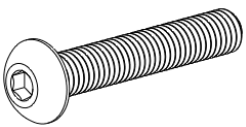

Dee Zee Cares - Please Recycle

JK Cowl Light Bracket Installation Instructions

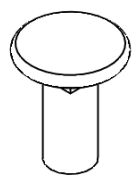
DZ 4445JK Jeep Wrangler JK 2007-2018

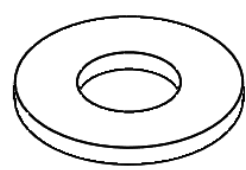
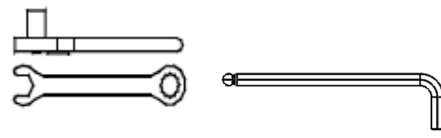
<p>A Driver Bracket</p>  <p>B 2653RP X1</p>	<p>B Passenger Bracket</p>  <p>B 2653LP X1</p>	<p>C Accessory Mount Bracket</p>  <p>B 2590P X2</p>
<p>D M8-1.25 X 40mm Button Head Bolt</p>  <p>PN 680B X4</p>	<p>E 1/4 USS Flat Washer (Bigger)</p>  <p>PN 843 X4</p>	<p>F Spacer</p>  <p>PN 1283 X4</p>
<p>G M5 X 30mm Button Head Bolt</p>  <p>PN 1302 X4</p>	<p>H 1/4" Flat Washer (Smaller)</p>  <p>PN 72B X4</p>	<p>I M8 Carriage Bolt</p>  <p>PN 498 X4</p>
<p>J M8 Hex Flange Nut</p>  <p>PN 526 X4</p>	<p>K 5/16" I.D. Black Plastic Washer</p>  <p>PN 270 X4</p>	<p>Required tools</p>  <p>13mm T40 Torx T35 Torx</p> <p style="text-align: right;">Allen Wrench 3mm 5mm</p>

1

First remove the 4 bolts in the driver's side cowl using a T40 Torx on the side and a T35 Torx on the top.

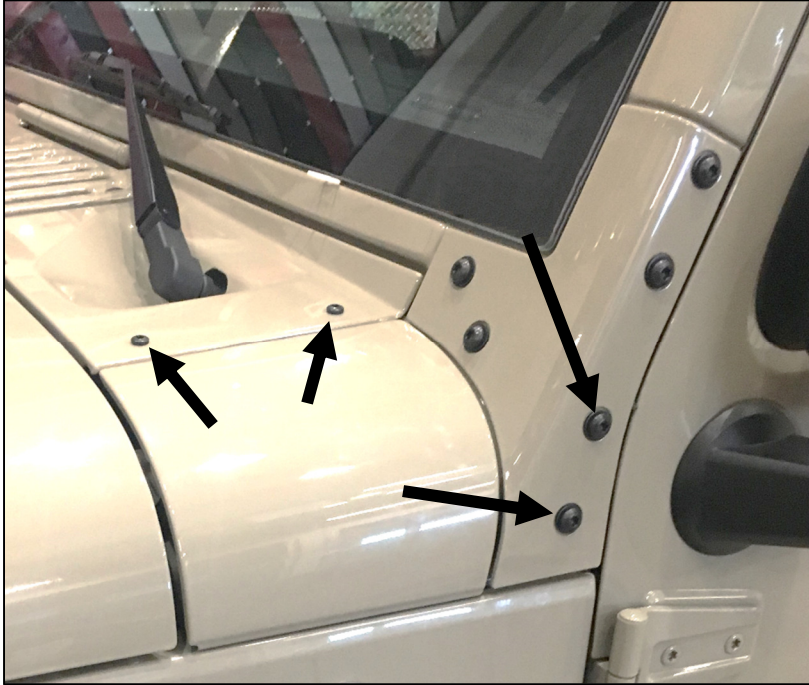

2

Set a plastic washer (K) in both of the upper locations of the cowl.

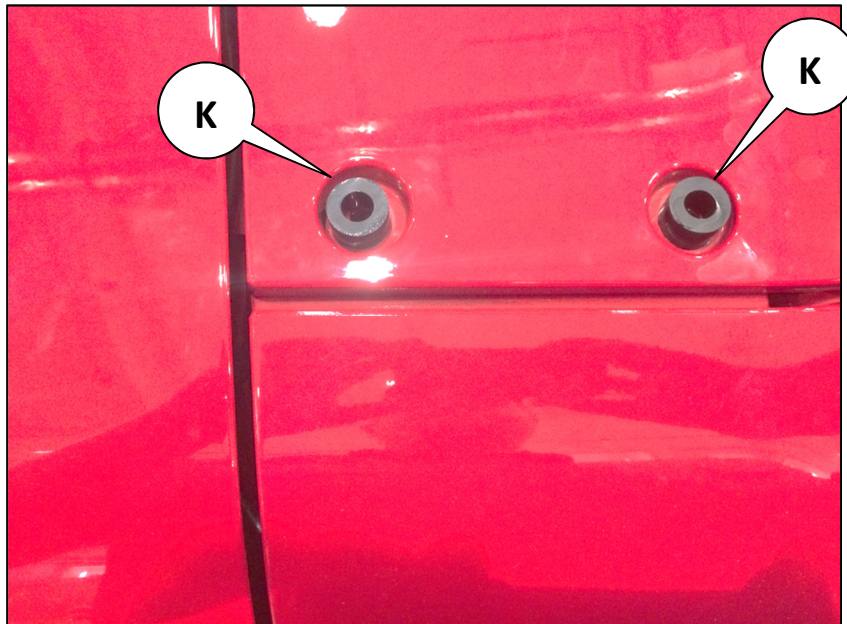

3

Install bolts (D), washers (E), and spacers (F) through the lower holes of the driver side bracket (A).

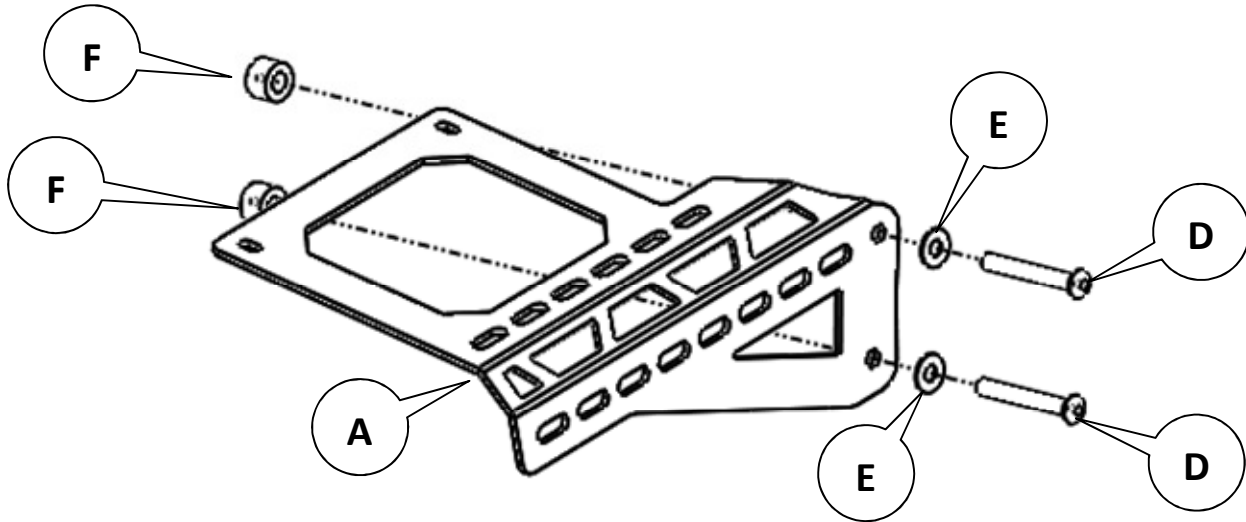

4

Install the bolts from the previous step into the lower holes of the cowl. Do not fully tighten at this time.



5

Install bolts (G) and washers (H) through the bracket and washers in the upper locations of the cowl. Fully tighten the lower bolts then tighten the upper bolts.

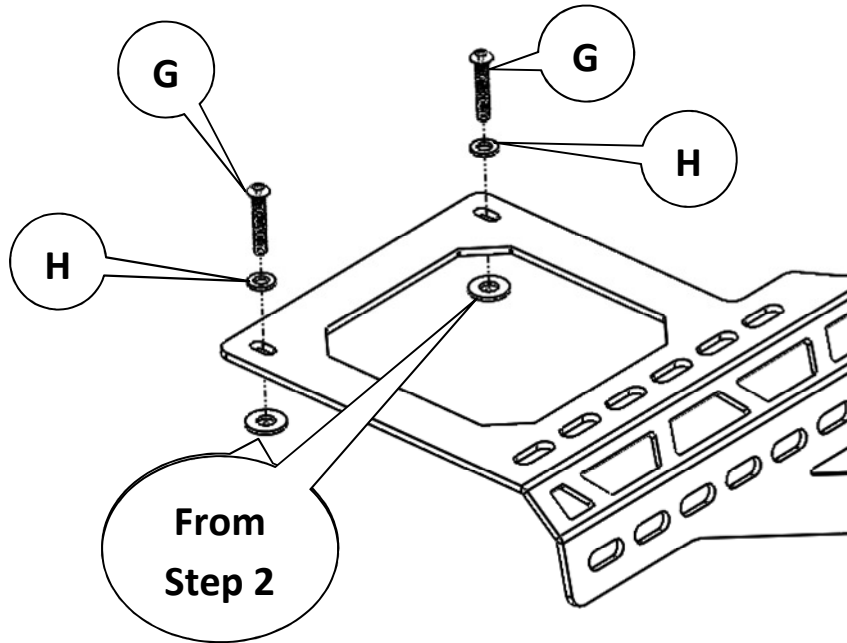
**6**

Mounting the accessory mount bracket (C) is optional. If you want to mount the accessory mount bracket locate the desired position on the drivers bracket in either the top or side slots. Then install bolt (I) from the bottom side, through the bracket, and use nut (J). Fully tighten bracket.

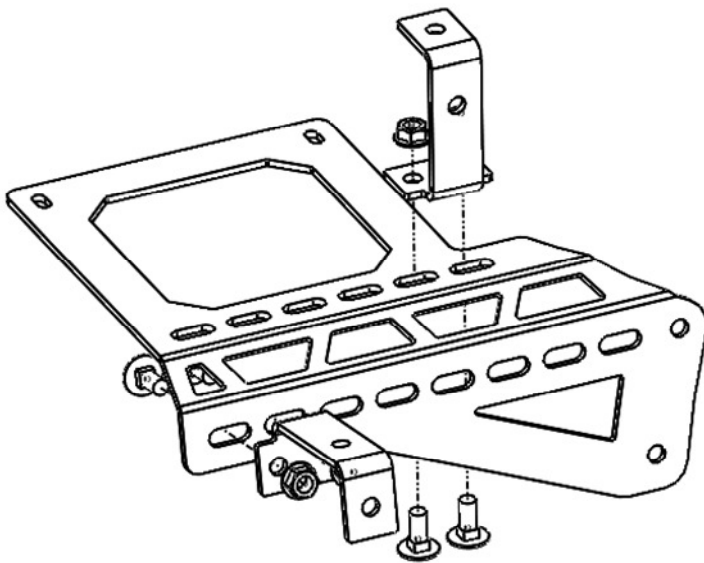

When bracket or any accessory is mounted on the top of the brackets the windshield will not be able to be folded down. If the bracket or any accessory is mounted on the side there is a possibility that the windshield may not be able to be folded down. Bracket is not intended for a Light Bar.

Repeat Steps 1-6 on Passenger side Using bracket B instead of A.

Learn more about off-road lights we have.