

4" OVAL BENT END SIDEBARS  
2019 CHEVY SILVERADO/GMC SIERRA 1500 CREW CAB  
EXCLUDES BODY LIFT KIT



**(W)**  
**INSTALLATION INSTRUCTIONS**  
**4" OVAL BENT END SIDEBARS**  
**2019 CHEVY SILVERADO/GMC SIERRA 1500 CREW CAB**  
**EXCLUDES BODY LIFT KIT**  
**PART # DZ 373537;DZ 373539**

**PARTS LIST:**

1	Driver/left side 4" Oval Bent End Sidebar	1	Passenger/right Rear Mounting Bracket
1	Passenger/right side 4" Oval Bent End Sidebar	4	1/2" x 2" Hex Bolts
1	Driver/left Front Mounting Bracket	4	1/2" Lock Washers
1	Passenger/right Front Mounting Bracket	4	1/2" x 1-1/2" OD x 1/8" Large Flat Washers
2	Center Support Brackets	2	8-1.25mm x 25mm Combo Bolts
1	Driver/left Rear Mounting Bracket		

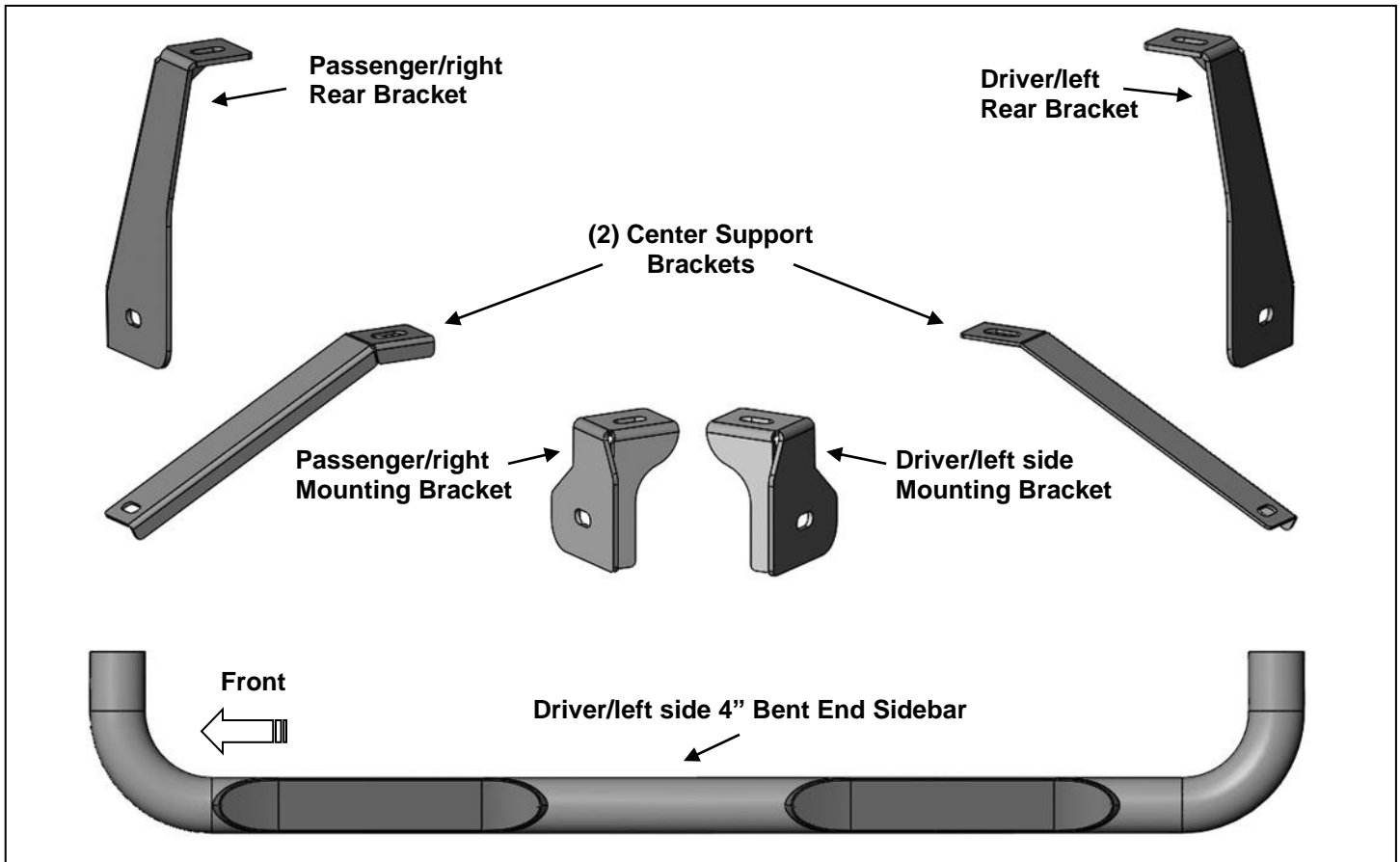

**PROCEDURE:**

**REMOVE CONTENTS FROM BOX. VERIFY ALL PARTS ARE PRESENT. READ INSTRUCTIONS CAREFULLY BEFORE STARTING INSTALLATION. ASSISTANCE IS RECOMMENDED.**

1. Start the installation under the driver/left side of the vehicle. Locate the front body mount, **(Figure 1)**. Remove the front body bolt.
2. Select the Driver/left side Front Bracket, **(Figure 2)**. Line up the upper slot on the Bracket with the body bolt hole. Reuse the factory body bolt to attach the Bracket to the top of the body mount, **(Figure 2)**.
3. Move to the center mounting location, **(Figure 3)**. Repeat **Steps 1 & 2** to install (1) Center Support Bracket to the center body mount, **(Figure 4)**.
4. Move to the rear mounting location, **(Figure 5)**. Repeat **Steps 1 & 2** to install the Rear Mounting Bracket to the rear body mount, **(Figure 6)**.
5. Carefully unwrap and select the Driver/left Sidebar. Use the illustration above to help identify the correct Sidebar. With assistance, line up the front end of the tube with the front Bracket slot, **(Figure 7)**. Use (1) 1/2" Hex Bolt, (1) 1/2" Lock Washer and (1) 1/2" Flat Washer to attach

the front end of the Sidebar tube to the Front Bracket, **(Figure 8)**. Snug but do not tighten hardware at this time.

6. Attach the Sidebar to the Center Support Bracket using (1) 8mm Combo Bolt, **(Figures 9 & 10)**. Do not tighten hardware at this time.
7. Repeat **Step 5** to attach the rear end of the Sidebar to the Rear Bracket, **(Figures 11 & 12)**.
8. Level and adjust the Sidebar as necessary and fully tighten all hardware.
9. Repeat **Steps 1—8** for Passenger/right Sidebar installation.
10. Do periodic inspections to the installation to make sure that all hardware is secure and tight.

**To protect your investment**, wax this product after installing. Regular waxing is recommended to add a protective layer over the finish. Do not use any type of polish or wax that may contain abrasives that could damage the finish. Mild soap may be used also to clean the Sidebar.

### Driver/left Side Installation Pictured

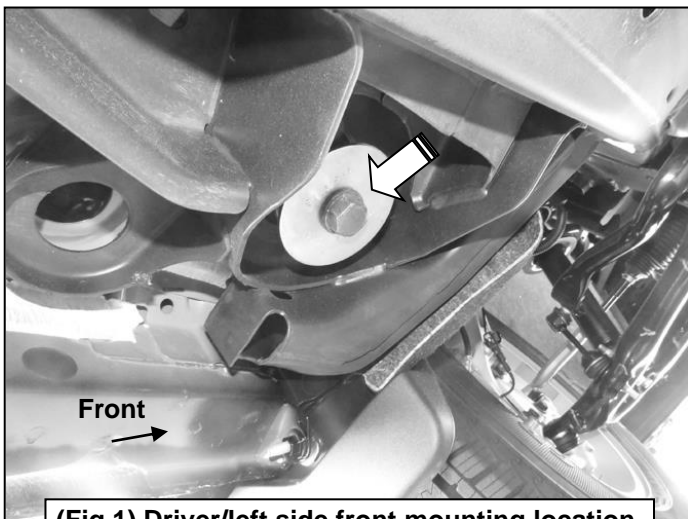

**(Fig 1) Driver/left side front mounting location**

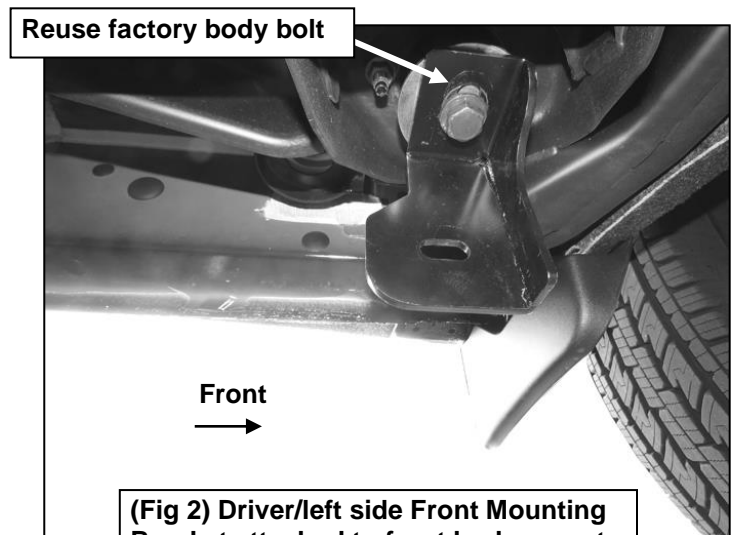

**(Fig 2) Driver/left side Front Mounting Bracket attached to front body mount**

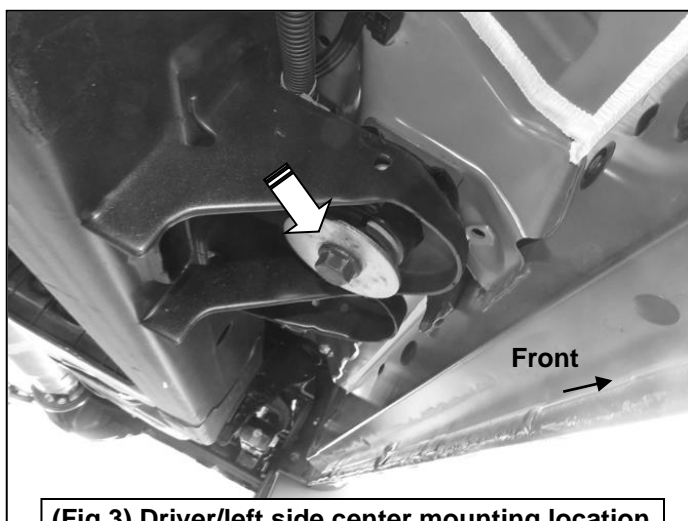

**(Fig 3) Driver/left side center mounting location**

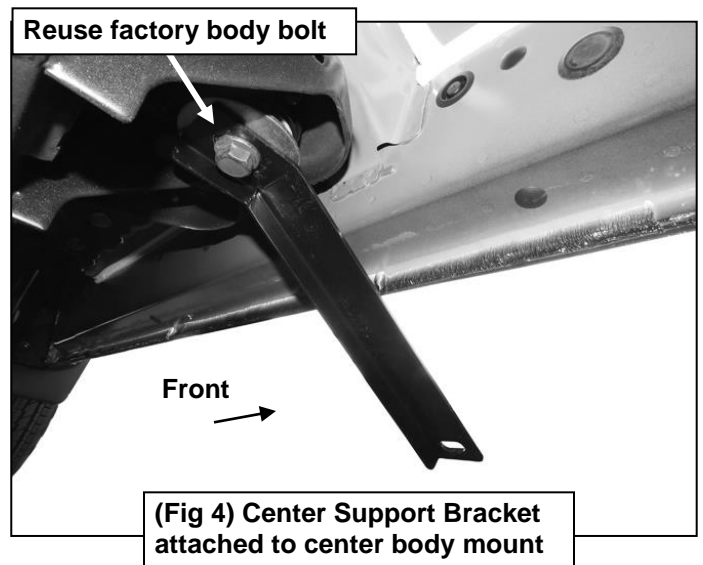

**(Fig 4) Center Support Bracket attached to center body mount**

### Driver/left Side Installation Pictured

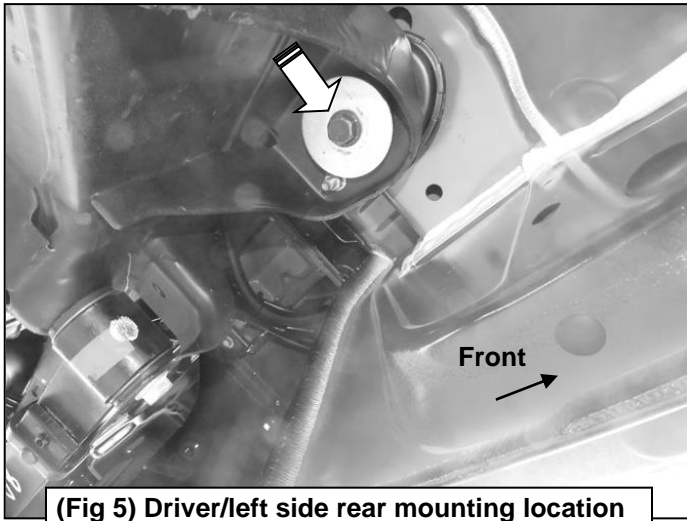

(Fig 5) Driver/left side rear mounting location

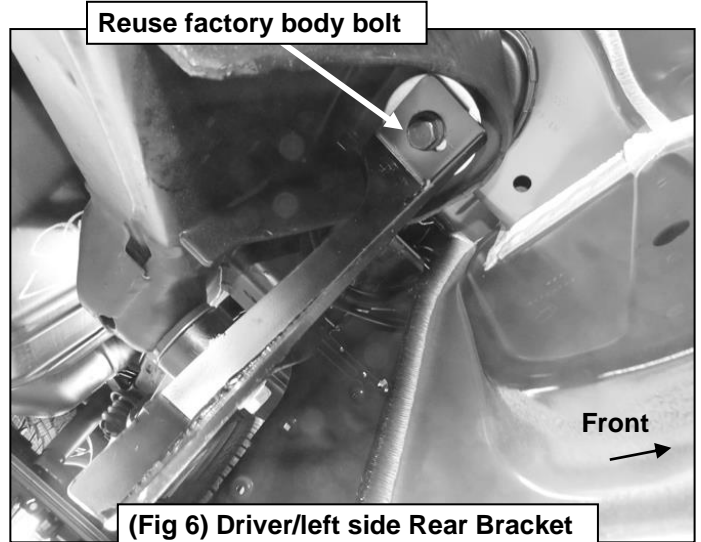

Reuse factory body bolt

(Fig 6) Driver/left side Rear Bracket attached to the rear body mount

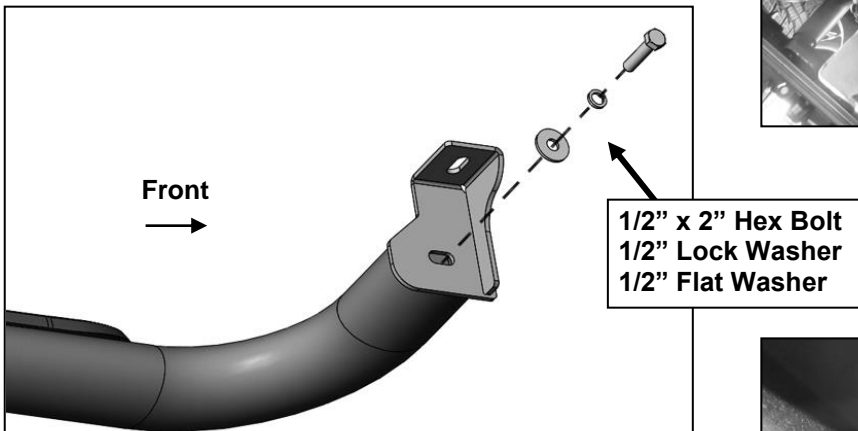

1/2" x 2" Hex Bolt  
1/2" Lock Washer  
1/2" Flat Washer

(Fig 7) Driver/left front of Sidebar attached to Front Mounting Bracket illustrated

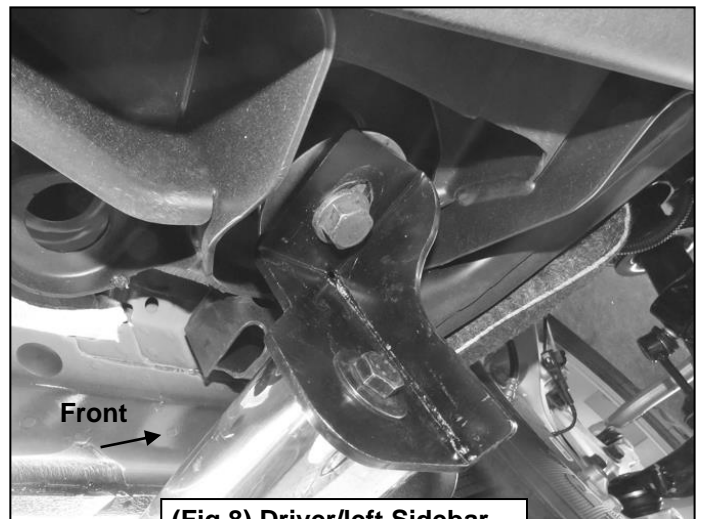

(Fig 8) Driver/left Sidebar attached to Front Bracket

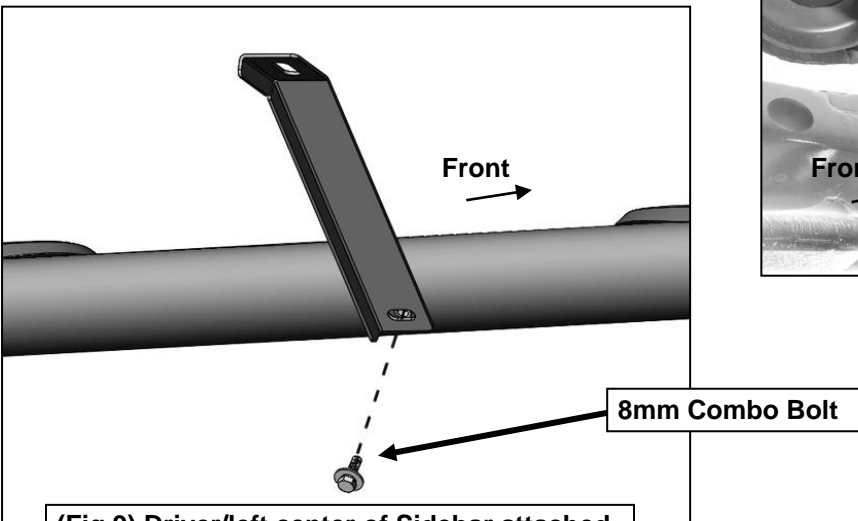

8mm Combo Bolt

(Fig 9) Driver/left center of Sidebar attached to Center Support Bracket illustrated

**Driver/left Side Installation Pictured**

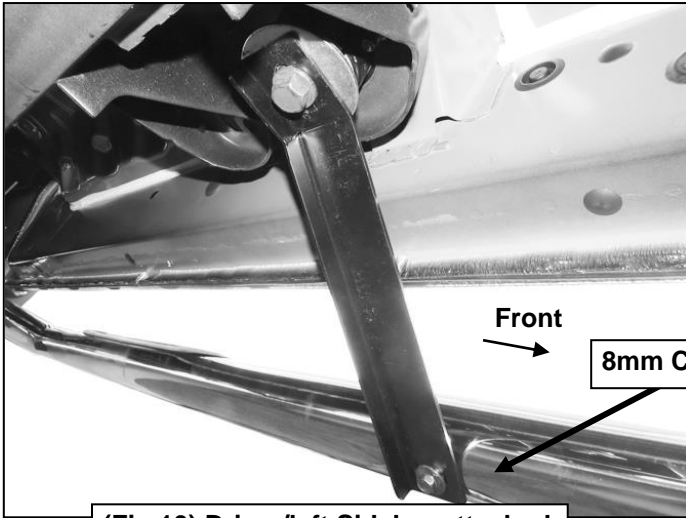

**(Fig 10) Driver/left Sidebar attached to Center Support Bracket**

**8mm Combo Bolt**

**1/2" x 2" Hex Bolt  
1/2" Lock Washer  
1/2" Flat Washer**

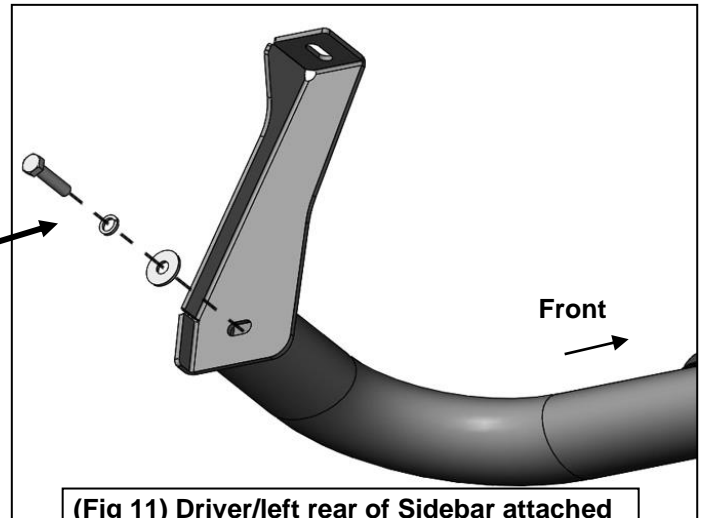

**(Fig 11) Driver/left rear of Sidebar attached to the Rear Mounting Bracket illustrated**

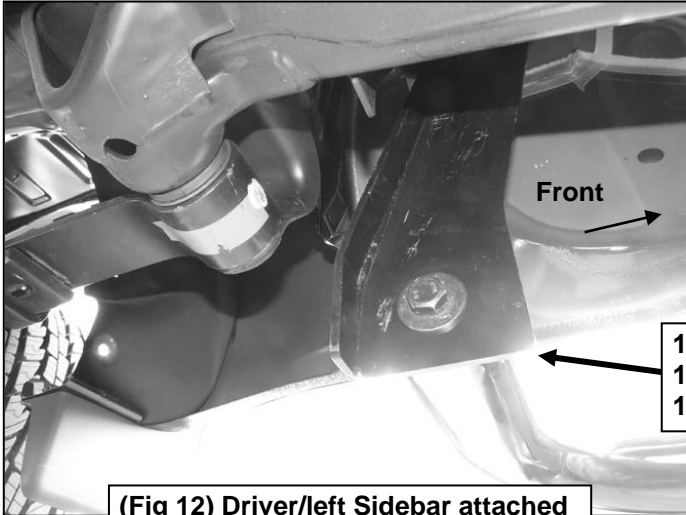

**(Fig 12) Driver/left Sidebar attached to the Rear Mounting Bracket**

**1/2" x 2" Hex Bolt  
1/2" Lock Washer  
1/2" Flat Washer**