



## Dee Zee Toolbox Installation Instructions

*Congratulations on your purchase of a quality Dee Zee product. Dee Zee is recognized as having the highest quality running boards and accessories on the market today. We have earned this reputation by offering our customers a product they can be proud to place on their vehicles. Dee Zee meets all the criteria of manufacturing a custom-fit product which guarantees it to be the easiest product to install.*

**Note:** Please take time to read all of the instructions before beginning this installation.

DZ 91716 DZ 91717  
TRIANGLE BOX

**A** Triangle Trailer Toolbox

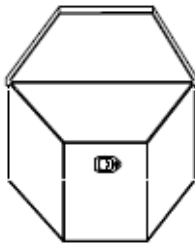

X1

**B** 1/4 X 1" Sheet Metal Screw



X4

Tools Required

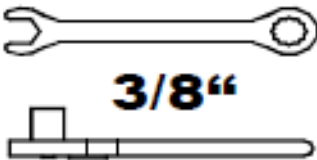

3/8"

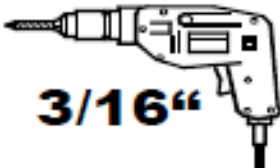

3/16"

**1**

Position the triangle trailer toolbox (A) onto the trailer tongue of your trailer. Drill four 3/16" holes through the bottom of the triangle trailer toolbox (A) and the trailer tongue.

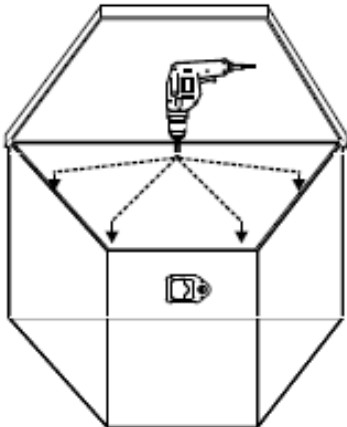

**2**

Secure the triangle trailer toolbox (A) to the trailer tongue of your trailer using the provided 1/4 x 1" sheet metal screws (B). Tighten into place using a 3/8" wrench / socket.



3/8"

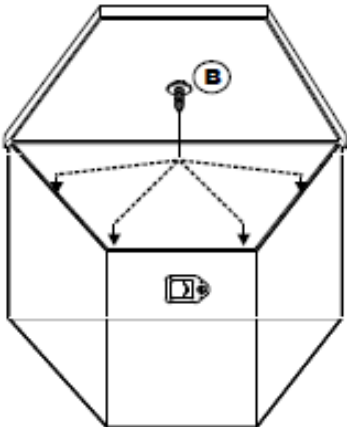

**MAINTENANCE INSTRUCTIONS:** All locks, latches, latching rods, and hinges should be lubricated regularly to assure smooth and proper operation for the life of the toolbox.

boite

**Toolbox Latch Assembly**

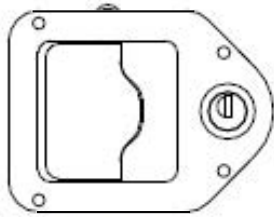

**Front View**

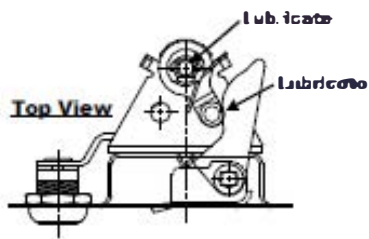
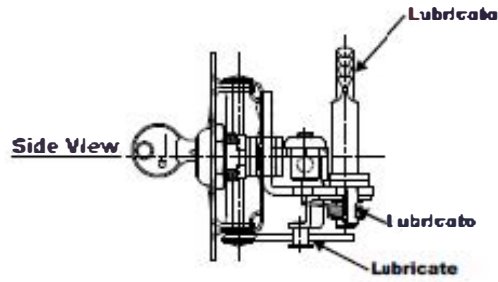

**Top View**

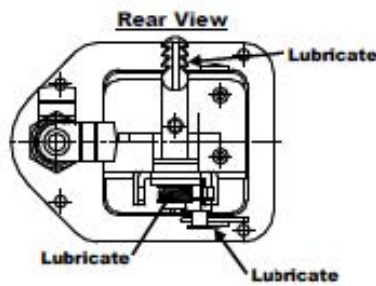

**Rear View**

**Toolbox Catch Assembly**

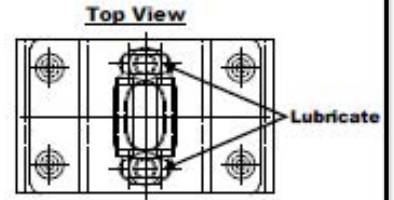

**Top View**

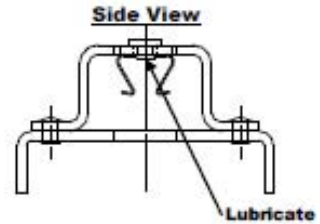

**Side View**

# Replacement Parts for Triangle Trailer Toolbox

## Shocks

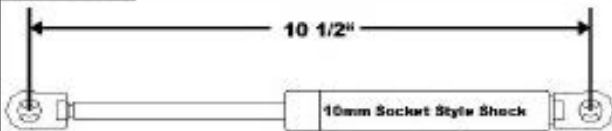

10mm Socket Style Shock					
Shock #	20#	40#	60#	80#	100#
Part Number	SL-3220	SL-3240	SL-3260	SL-3280	SL-32100

## Miscellaneous Parts

Frame Latch Gasket  
Part Number: TB85409

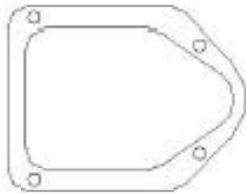

Striker Assembly  
Part Number: TB85616



1/4" Flat Washer  
Part Number: PN 72



1/4 x 1" Sheet Metal Screw  
Part Number: PN 97



Latch Cover Rivet  
Part Number: PN 288



Latch Rivet  
Part Number: PN 117



Hinge Rivet  
Part Number: PN 208

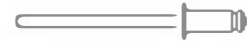

Rear View: Locking Latch  
Part Number: TB85613

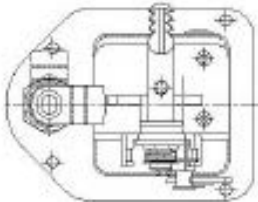

Rear View: Non-Locking Latch  
Part Number: TB85614

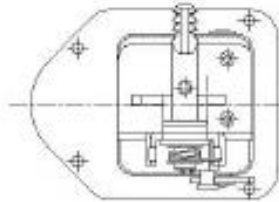

Poly Box Masp  
Part Number: K1590



Poly Box Washer  
Part Number: PN 914

