



Dee Zee Toolbox Installation Instructions

Congratulations on your purchase of a quality Dee Zee product. Dee Zee is recognized as having the highest quality running boards and accessories on the market today. We have earned this reputation by offering our customers a product they can be proud to place on their vehicles. Dee Zee meets all the criteria of manufacturing a custom-fit product which guarantees it to be the easiest product to install.

Note: Please take time to read all of the instructions before beginning this installation.

Warning! If it is necessary to drill any holes into the vehicle, Dee Zee recommends putting a sealant or rust inhibitor around all holes drilled into the body of the vehicle.

Cleaning Instructions: To maintain the bright finish of your Dee Zee Stainless Steel Toolbox, clean with a mild detergent and then apply a high grade automotive type wax.

Chest Tool Box Installation Instructions

Chest Toolbox: _____

Toolbox lid design may vary from picture with different toolbox models.

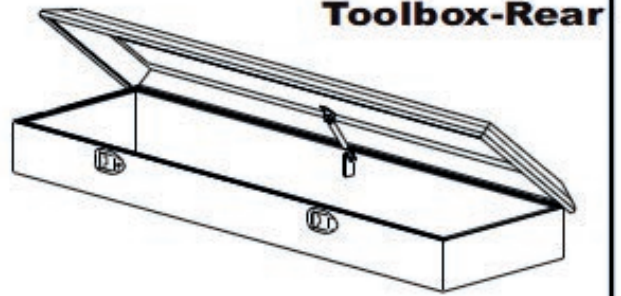
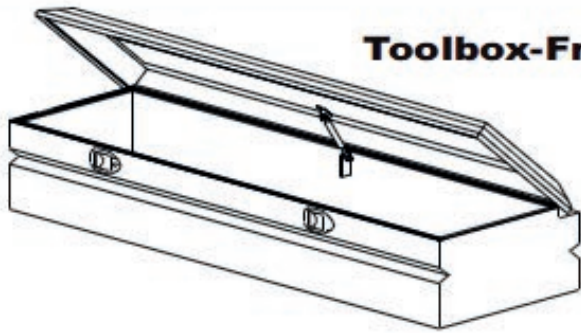

A

X1

B
1/4 x 1" Sheet
Metal Screw



X4

C
Foam Tape



X2

Tools Required:

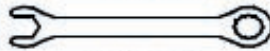

3/8"

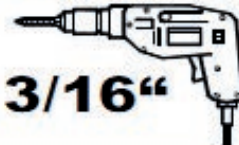

3/16"



1

Peel backing off of foam tape (C).

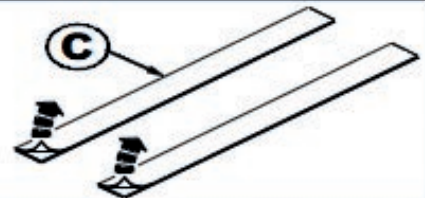

2 Place foam gasket (C) onto the bottom of toolbox (A). Trim foam gasket (C) so that it is flush with the ends of toolbox (A).

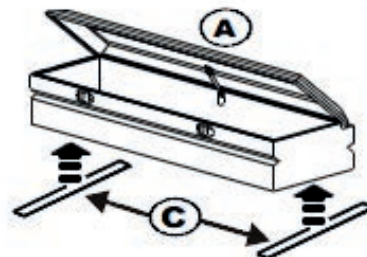
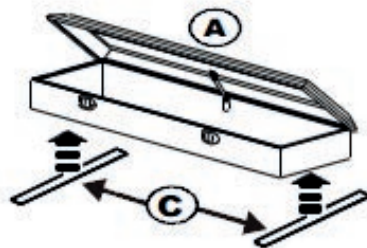

3

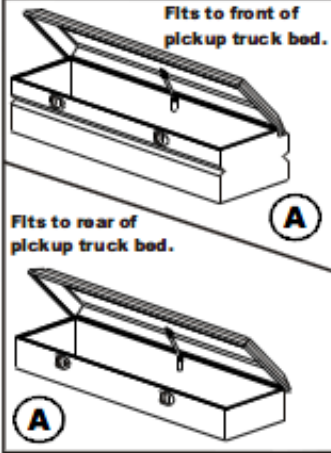

Place toolbox (A) into the back of your pickup truck bed.

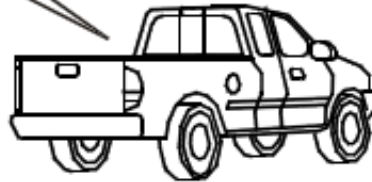

4

Locate the toolbox (A) in the pickup truck bed and then mark four hole locations in the bottom of toolbox (A). Drill a 3/16" hole at each marked hole location.

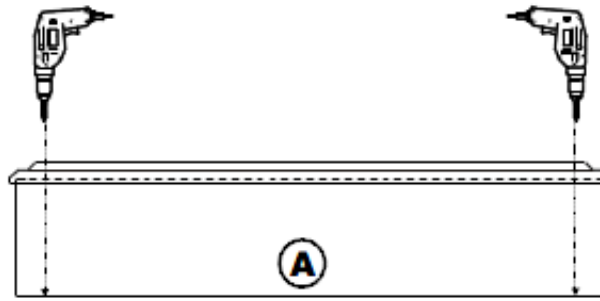
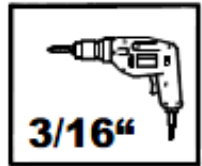

5

Attach toolbox (A) to the pickup truck bed using 1/4 x 1" sheet metal screws (B). Tighten them into place using a 3/8" wrench / or socket.

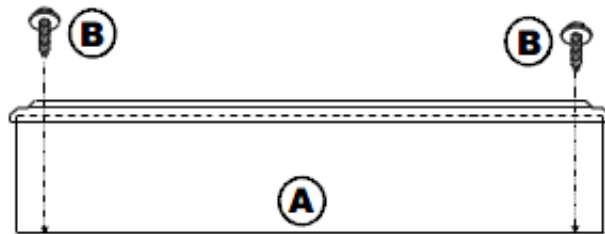
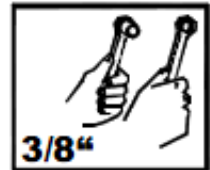

MAINTENANCE INSTRUCTIONS: All locks, latches, latching rods, and hinges should be lubricated regularly to assure smooth and proper operation for the life of the toolbox.

Toolbox Paddle Latch Assembly

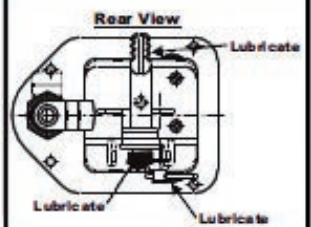
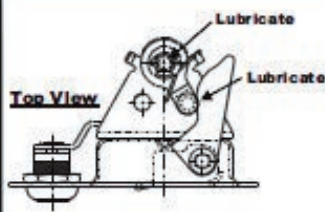
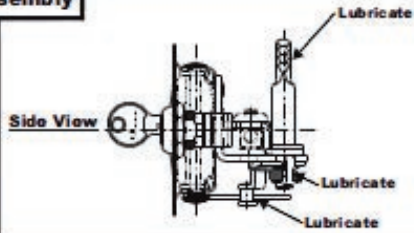
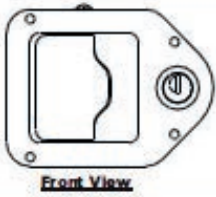

Toolbox Catch Assembly

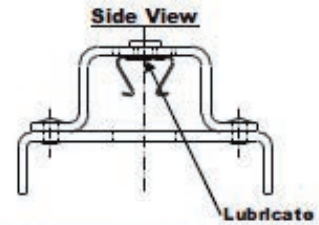
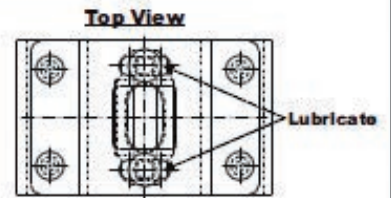

Replacement Parts for Toolbox

Toolbox Hook-Paddle Latch Assembly

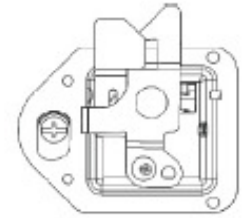
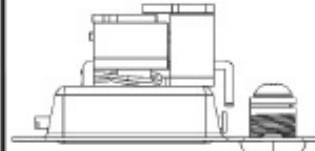
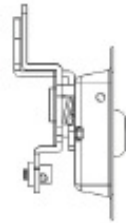

Toolbox Hook-Catch Assembly

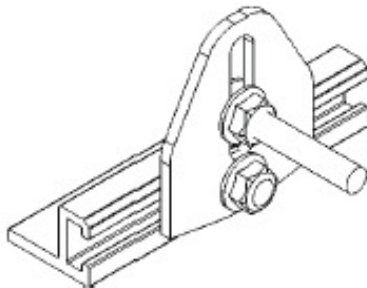

C-Channel Extrusion
Part Number: B 1602

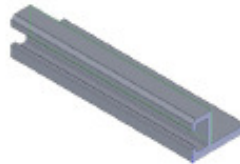

Rotary Plate - Adjustable Latch
Part Number: B 1601



1/4-20 Hex Head Cap Screw
Part Number: PN 70B



1/4-20 Threaded Stud
Part Number: PN 810



1/4-20 Flange Locknut Zinc
Part Number: PN 178



1/4-20 Nylon Locknut Ultra
Part Number: PN 341B



Nylon Standoff
Part Number: PN 860

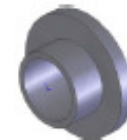

Pushbutton - Blue Series

Spacer Brace for Push Button
Part Number: B 1623



Adjustable Latch
Part Number: B 1610



Carburetor Clip 7R
Part Number: LCC-2



Mounting Bracket
Part Number: B 1625



Shock Mount
Part Number: SL-69



Nylon Bushing
Part Number: PN 116



5/16-18 Nylon Insert Locknut
Part Number: PN 510



10 x 1/8 Square Pan Self Drill
Part Number: PN 872



Push Latch
Part Number: TB 85623



Rotary Latch
Part Number: TB 85624



Rod End Adaptor
Part Number: TB 85626







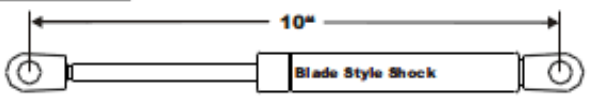
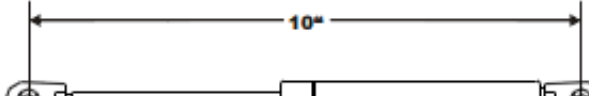
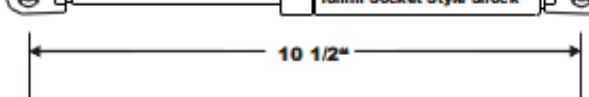
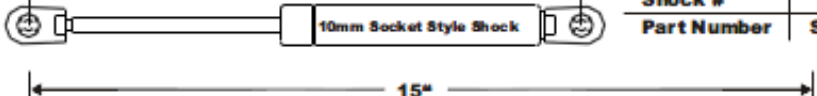



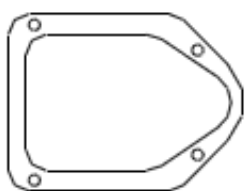

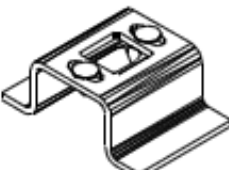

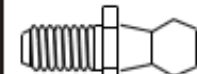
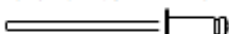



Replacement Parts for Toolbox Cont.

Shocks

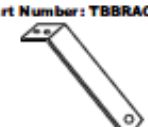
 <p>10"</p> <p>Blade Style Shock</p>	Blade Style Shock					
	Shock #	20#	40#	70#		
	Part Number	SL1-20	SL1-40	SL1-70		
 <p>10"</p> <p>10mm Socket Style Shock</p>	10mm Socket Style Shock					
	Shock #	20#	40#	70#		
	Part Number	SL-3020	SL-3040	SL-3070		
 <p>10 1/2"</p> <p>10mm Socket Style Shock</p>	10mm Socket Style Shock					
	Shock #	20#	40#	60#	80#	100#
	Part Number	SL-3220	SL-3240D	SL-3260D	SL-3280D	SL-32100D
 <p>15"</p> <p>10mm Socket Style Shock</p>	10MM Socket Style "Long" Style Shock					
	Shock #	90#	40#			
	Part Number	SL-3390	SL-3340			

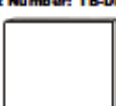
Miscellaneous Parts

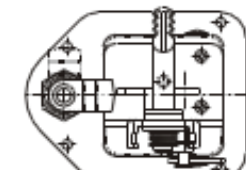
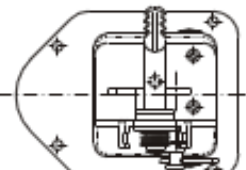
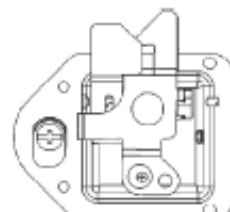
Foam Latch Gasket Part Number: TB85409 	Shock Clip Part Number: SL-81 	Striker Assembly Part Number: TB85616 	Shock Mount Nut Part Number: PN 301 	Latch Cover Rivet Part Number: PN 285 	
	Shock Mount Part Number: SL-69 			Latch Rivet Part Number: PN 157 	
				Hinge Rivet Part Number: PN 762 	
Rod Clip Part Number: LCC-1 	Rod Guide Part Number: TB85615 	1/4" Flat Washer Part Number: PN 72B 	1/4 x 1" Sheet Metal Screw Part Number: PN 97B 	1/4 x 1" Sheet Metal Screw Part Number: PN 97 	1/4 x 1" Button Head Screw Part Number: PN 96B 
	1/4" Locknut Part Number: PN 341B 	Mounting Bracket Part Number: TBBRACE1 	Divider Mounting Channel Part Number: TB-Channel 	Toolbox Divider Part Number: TB-Divider 	Toolbox Divider Tape Part Number: CO-tape 
Rear View: Locking Latch Part Number: TB85613 	Rear View: Non-Locking Latch Part Number: TB85614 	Rear View: Locking Hook Part Number: Tb85608 	Rear View: Non-Locking Hook Part Number: Tb85608 