



Exhaust System Installation
Single Side Exit w/ 4" Slash Cut Tip
Part # 24200, 24201, 24203, 24260, 24261, 24263
1999 - 2006 Chevrolet Silverado
1999 - 2006 GMC Sierra (4.8 / 5.3L)

Please take time to read and understand these installation instructions.

We recommend that the installation of this system be performed by a qualified service center or professional muffler installer who has the necessary equipment, tools and experienced personnel. However, if you decide to perform this install, the use of a hoist and an additional person will be required.

CAUTION: Never work on a hot exhaust system. Allow time for the vehicle to cool. Always wear eye protection when working under a vehicle.

Bill of Materials:

- 1- Intermediate Pipe Assembly
Part # 24200/24260- (16SE4206)
Part # 24201/24261- (16SE4239)
Part # 24203/24263- (16SE4226)
- 2- Muffler Assembly (16SE2022)
- 3- Tail Pipe Assembly
Part # 24200/24201/24203- (16SE4220)
Part # 24260/24261/24263- (16SE4281)
- 4- Over the Axle Pipe Assembly (16SE4221)
(ONLY Part# 24200, 24201, 24203)
- 5- dB Slash Cut Tip (16SE3023)
- 6- Hardware Kit
Part # 24200/24201/24203- (16SE7200)
Part # 24260/24261/24263- (16TA7205)

Recommended Tools:

- Safety Glasses
- Torque Wrench
- Soapy Water
- 15mm Wrench or Deep Socket

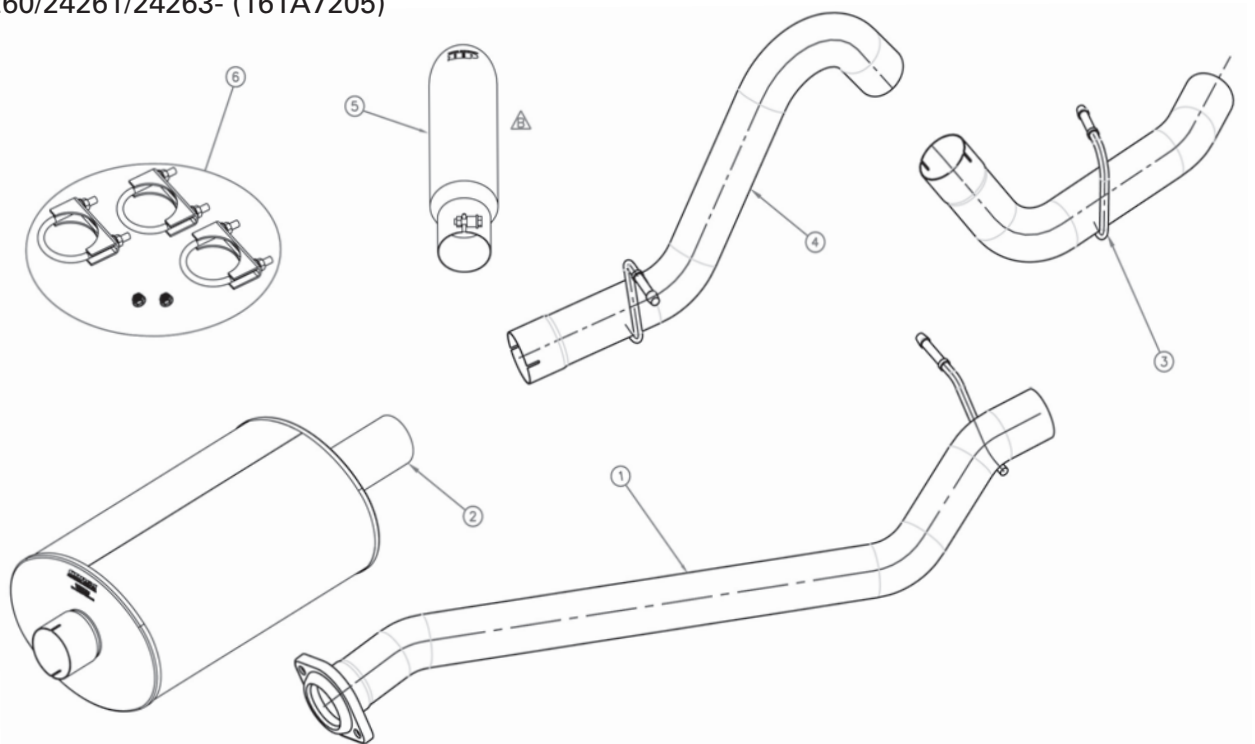

Stock Exhaust Removal Instructions:

In order to remove factory system from vehicle, the pipe between the catalytic converter and muffler must be cut.

NOTE: Recheck your measurement and be sure to support muffler to prevent injury.

- 1) Unbolt intermediate-to-header pipe flange using 15mm socket (**See Fig. A**) and remove both bolts. Be sure to support muffler to prevent injury. Use lubricant to loosen bolts if necessary. Keep bolts as they will be needed for the final installation.
- 2) Next, remove hanger from rubber grommet located just in front of the muffler (near muffler inlet) (**See Fig. B**). It may be easier to first remove rubber grommet from frame hanger. Be sure to keep the rubber grommet. **Note: Using a soapy solution on the grommet hole will make the job easier.**

- 3) Remove Muffler Extension Pipe and Tailpipe hangers from rubber grommets (**See Fig. C**). Be sure to keep the rubber grommets. Now entire system can be removed in one piece.



FIG. A



FIG. B

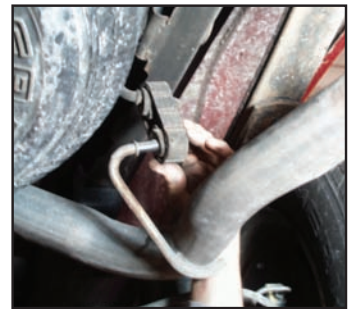

FIG. C

Installation of dB Performance Exhaust System:

NOTE: The supplied double edge clamps in this system will crush and permanently deform the exhaust piping as they are tightened. **DO NOT** tighten these clamps any more than is necessary to lightly hold the exhaust components in place, until the very end of this installation process. It will be difficult or impossible to make any positional or rotational adjustments to the exhaust system after these clamps have been tightened down.

VERY IMPORTANT: Align all clamps so that the open edge of the clamp bracket is parallel and aligned with the notch in the pipe, and the outside edge of the clamp bracket is approximately 1/8" from the end of the pipe expansion. (See Fig. 1) Failure to properly position or orient the clamps could result in a weak clamping load, or even a potential leak at the clamp joints.

IMPORTANT: Make sure that the small drain holes in the muffler are facing down when the muffler is installed. (See Fig. 2)

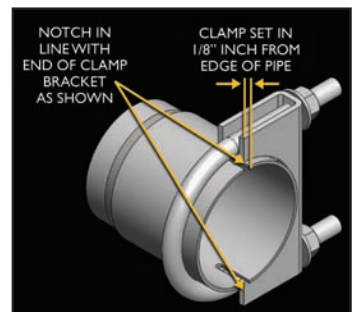

FIG. 1



FIG. 2

- 1) Locate Intermediate Pipe (**See Fig. D**) and position flange to header pipe flange. Insert bolts and hand tighten only (**See Fig. E**). Insert Intermediate Pipe hanger into rubber grommet (**See Fig. F**).
- 2) Next slide a clamp over Intermediate Pipe and slide slotted end of muffler onto Intermediate Pipe (**See Fig. G**) and snug-fit the clamp. Do not tighten clamp at this time.

Steps 3 & 4 for PN# 24200, 24201, 24203 ONLY

- 3) Locate the Muffler Extension Pipe (**See Fig. H**) and slide expanded end over Muffler outlet. Next, position the other end over the axle. Slide a clamp over end closest to the pipe hanger (expanded end of pipe). (**See Fig. I**). Now snug-fit the clamp but do not tighten clamp at this time.
- 4) Insert Muffler Extension Pipe hanger into rubber grommet (**See Fig. J**).

NOTE: It may be easier to insert hanger into rubber grommet before sliding pipe over Muffler outlet.

- 5) Locate Tailpipe Assembly (**See Fig. K**) and slide hanger into rubber grommet (**See Fig. L**). Slide Tailpipe into Extension Pipe Muffler outlet and slide clamp over Tailpipe inlet. Snug-fit the clamp. Do not tighten clamp at this time.

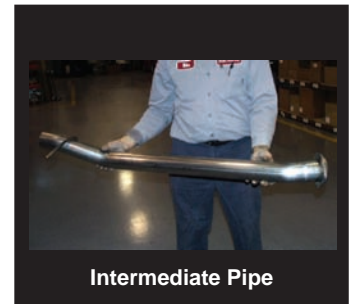

FIG. D



FIG. E



FIG. F

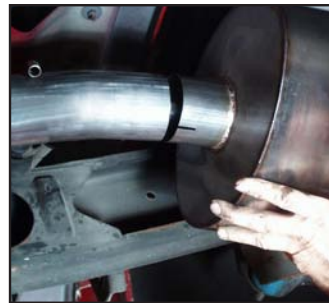

FIG.



FIG.



FIG. I

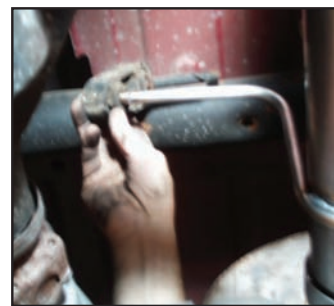

FIG. J



FIG. K

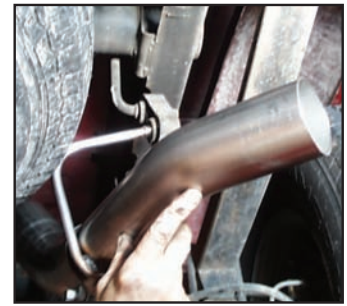

FIG. L

- 6) Locate the dB Performance slash cut tip, which has a clamp built into it. Slide the clamp end of the tip onto the end of the tailpipe. **(See Fig. M)** Rotate the tip until the dB Performance logo is centered on the top side of the tip. **(See Fig. N)** Snugly tighten the clamp as shown using a 15mm socket and ratchet, making sure to only tighten the clamp enough to hold the tip in place on the tailpipe. **(See Fig. O)**
- 7) Visually inspect the exhaust system position, tip alignment, clamp orientation and position, and exhaust pipe clearance. Make any necessary adjustments at the slip joints.
- 8) Starting with the Intermediate-to-Header, torque flange nuts to **30 ft.-lbs.**, all nuts on pipe clamps to **35 ft.-lbs.** and tip clamp to **45 ft.-lbs.**

IMPORTANT NOTE: When tightening flange bolts, alternately tighten each bolt so the spacing is even all the way around the flange connection. Uneven tightening may result in an exhaust leak.

- 9) It is **STRONGLY SUGGESTED** that all clamps be checked and re-tightened (if necessary) to the recommended torque after initial road testing of the vehicle, as thermal cycling has occurred on the system. Please wait until system has fully cooled to conduct this process.



FIG. M



FIG. N



FIG. O