

CUSCO LSD GUIDE



PROGRESSIVE EQUIPMENT®

CUSCO



Our objective is to develop your enjoyment
of driving through motor sports

CARROSSER

< Why a mechanical LSD is a necessity >

Standard Open Differential

A standard open differential is a component that transfers the rotational energy (torque) produced by the engine to the wheels. As the vehicle is making its turn, the inside wheel tends to rotate more slowly than the outer. If either of the wheel loses contact with the ground and is in a 'floating' state, the vehicle will lose all its traction capabilities and will not accelerate forward.

(This open differential is only designed to provide smooth turning characteristics of the vehicle, thus made for the outside wheel to rotate more revolutions than the inner when making a turn.)

*Assuming that Open Diff = Standard Factory Equipped Differential



OPEN DIFF / WEAK LSD

Open differential or weak LSD will spin inside wheel only.
If you try to accelerate more, inside wheel spins more and won't make much forward movement.



CUSCO LSD

With Cusco LSD, both wheel spin equally. This will give you maximum traction with stable and controllable movement.

The Purpose of an LSD

An LSD system eliminates the uneven power distribution which tends to apply more rotational drivetrain energy to the wheel that has less grip.

During aggressive driving (involving lots of turns), an LSD unit efficiently distributes the torque from the wheel with less grip capabilities to the wheel that has more, enabling more traction for the vehicle.

(Basically, it eliminates the difference in rotation between the left and right wheel during a vehicle turn, with even power distribution to each wheel).

Fig. 1



Fig. 2



Fig 1 :

During hard acceleration or drag launches, the LSD enables maximum traction.

Fig 2:

The Cusco LSD will still activate its locking system to 100% even when the car experiences wheel float. A standard torque sensing LSD is not sufficient during aggressive driving conditions, a mechanical unit is a must for any motorsports activity.

< Selecting LSD configurations >

< How an LSD Works >

There are many components inside the LSD casing, but the effectiveness of the unit (locking rate) depends on how much pressure is applied as well as the contact surface area of the clutch plates.

The effectiveness (locking rate) can be altered by several ways. Changing the cam angle of the pressure ring effectively works to change pressure and reaction time of locking, also changing the surface area of the clutch plates by its size or quantity to manage how much pressure is applied.

< The Difference Between 1 Way, 1.5 Way, and 2 Way >

CUSCO is the only manufacturer which provides a setting for all three options!

1. 1 - Way: The LSD is effective when load is applied to the differential (applied throttle load), and is not effective when load is not applied.
2. 1.5 - Way: The LSD is effective when load is applied to the differential (applied throttle load), and is half-effective when load is not applied.
3. 2 - Way: The LSD is effective both ways when there is load or no load applied to the differential.

Fig. 3



1 Way 1.5 Way 2 Way

Fig. 3 :

An 2 Way LSD will be active during both acceleration and deceleration which enables to maintain the same slip rate during cornering. This results in a extremely controllable movement and eliminates any unexpected movements. The 2 Way also gives stability when braking into a turn and cures the braking oversteer characteristic.

The 1 Way LSD is not active during deceleration.

Both the 1.5 Way and 2 Way LSD are effective on and between acceleration and deceleration.

Fig. 4

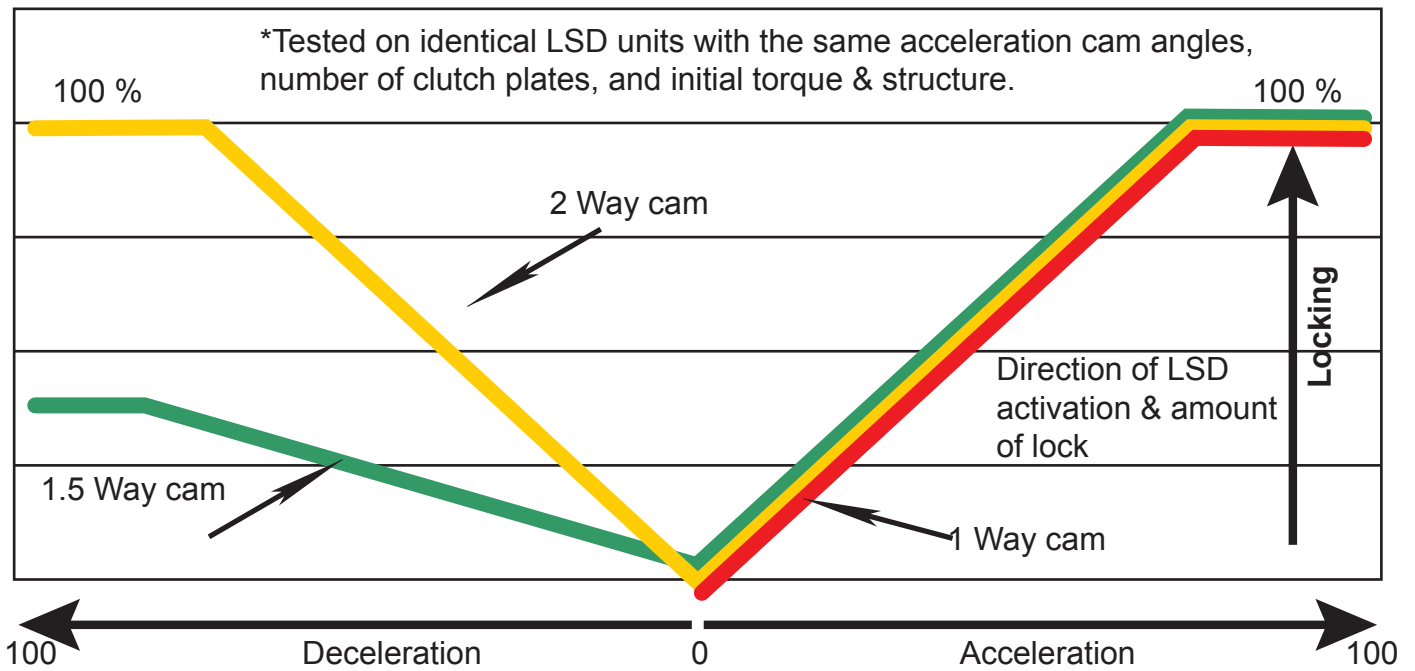

Cusco LSD has two different cam angle setting in one LSD unit !!

< Example >

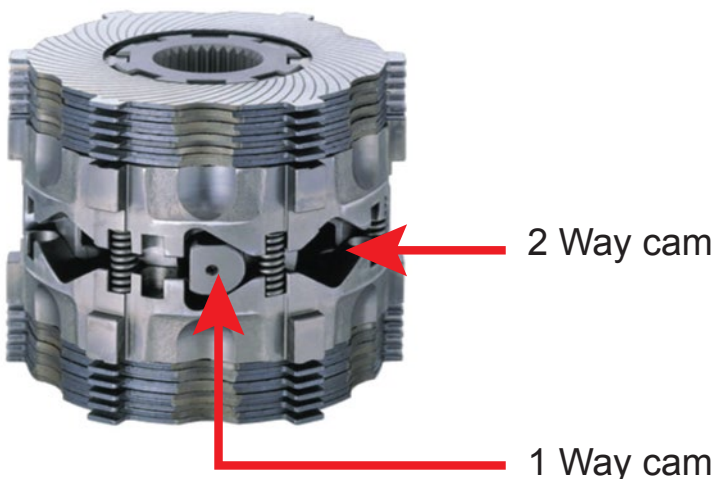

Cusco LSD has two different cam angle settings in one LSD unit which allows you to switch different cam angles without purchasing any additional parts. There are three different types of pressure rings; 1-Way & 1.5-Way, 1-Way & 2-Way, and 1.5-Way & 2-Way. The 1 Way LSD also has two different cam angles: 35 and 45 degree cam angle combinations. Please inquire within for availability and different applications.

Fig. 5

Flowchart for Choosing the Proper LSD Unit for Drifting, Circuit Driving, or Full Competition Use.

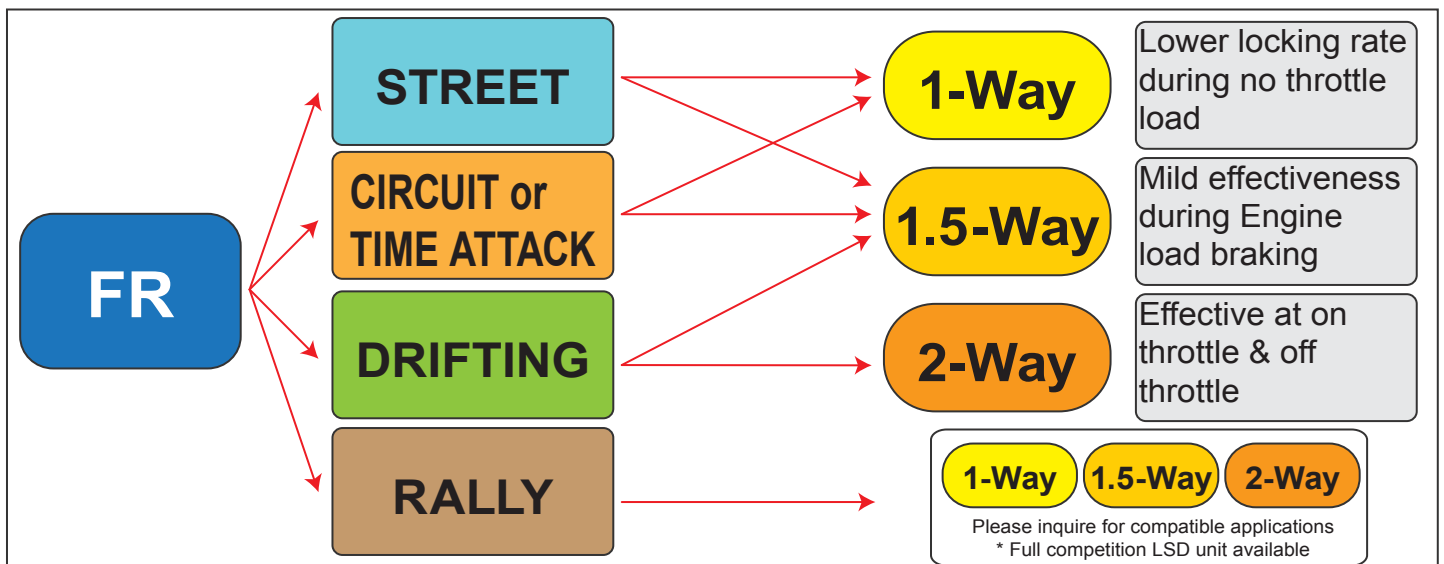
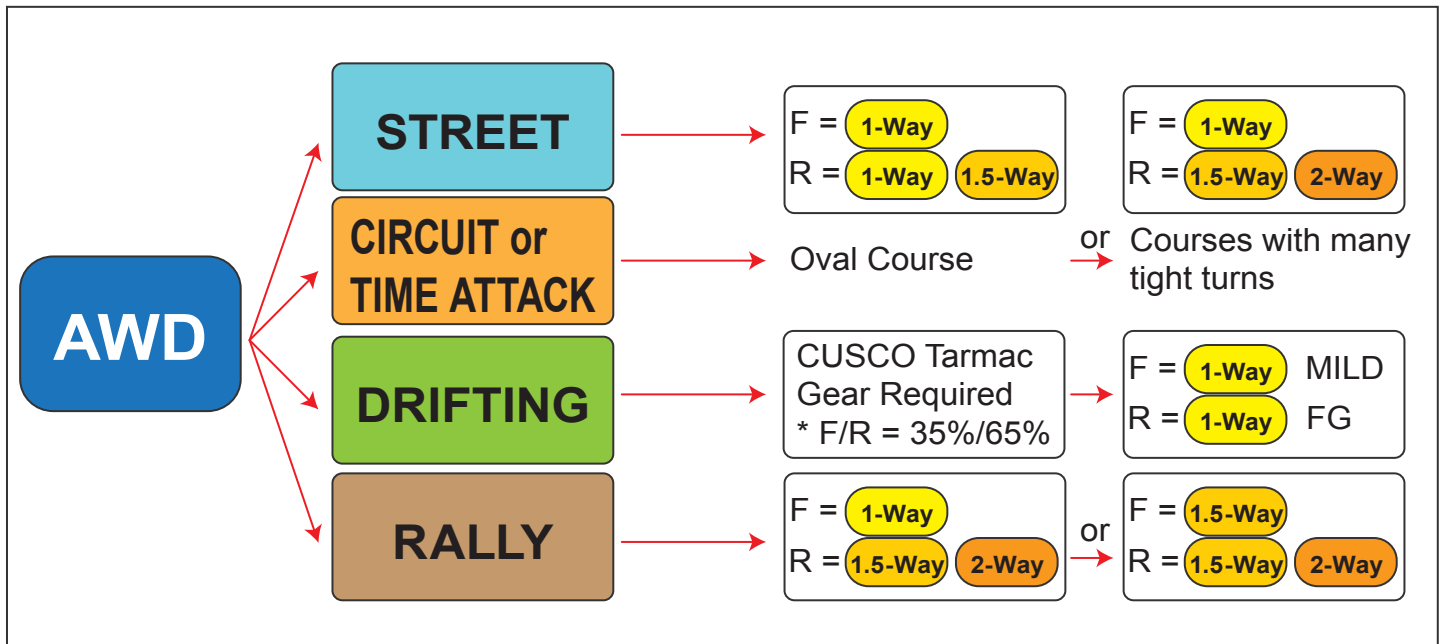
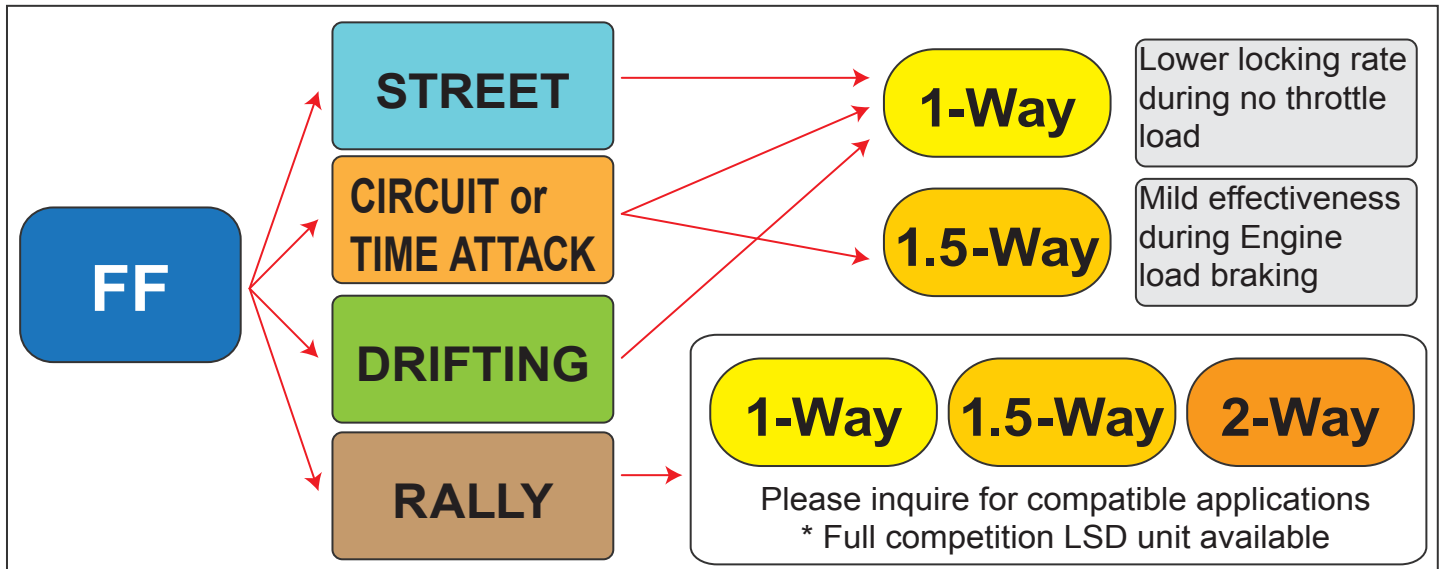

< Selecting Between the Type RS, Type MZ, or Type Hybrid >

Initial Torque

The initial torque of an LSD unit is ideally measured at its static pressure resistance. It is possible to measure when the LSD unit is equipped on a vehicle, however added variables that contribute to more resistance such as gears, bearings, and oil seals may vary to the final result. Another adding variable is the gear oil, which increases resistance depending on its temperature.

There are a lot of benefits from low initial torque setting; low power loss, low chattering noise, improved durability as clutch plates are lower pressured than type MZ 's initial torque, and higher efficiency with smoother oil flow between plates.

The primary difference between RS, MZ, and Hybrid units is the applied initial torque amount and the activation direction. <Fig. 6>

The MZ model LSD is designed where the activation pressure opposes the direction of the initial torque with the utilization of a cone spring. The LSD operation first becomes engaged when the opposing pressures start working against one another.

Fig. 6

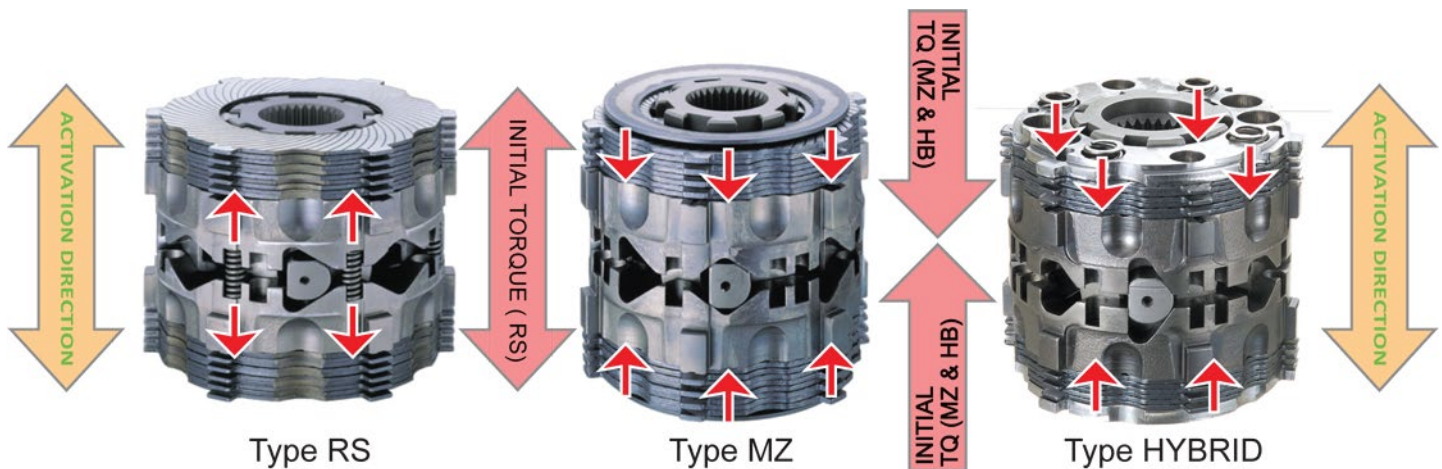

In the RS Model, the activation pressure is applied to the same direction of the initial torque with the utilization of a coil spring. Therefore, the initial torque is set lower than the MZ model enables a smoother and quicker initial clutch plates engagement from a non operational to a fully functioning state even despite a low initial torque rating is set. The virtues of a low initial torque setting is that it enables a smooth turn even while the LSD mechanism is not activated. Because of the coil spring design, it provides overall gentle and stable operation. <Fig. 7>

The Hybrid type has the smallest initial torque of all due to larger diameter coil spring.

The low initial torque which against to activation direction make the Hybrid LSD took advantage from RS and MZ.

Fig. 7

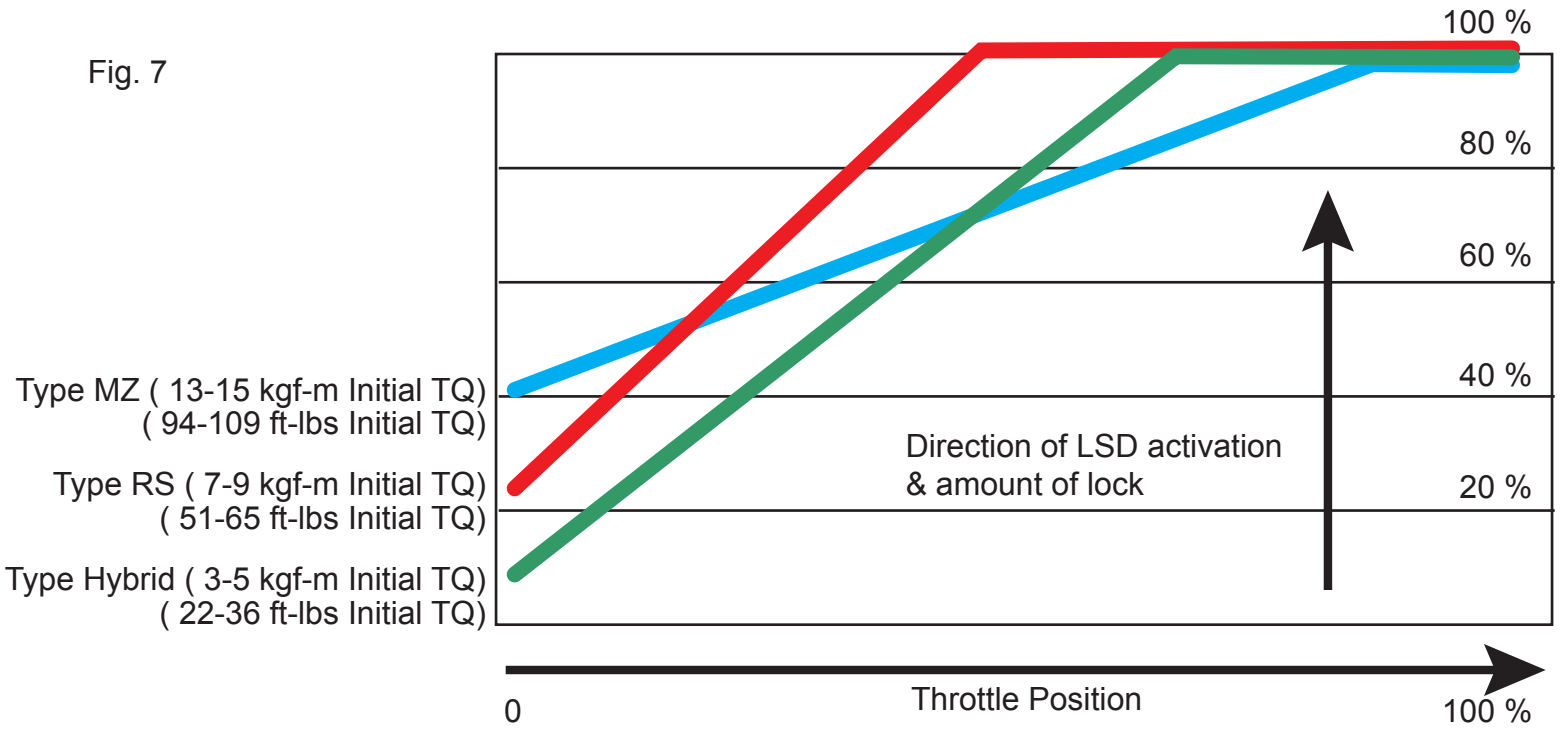

Initial Torque and LSD Activation Direction

The lower the initial torque setting, the more ineffective the unit may feel. This is because the initial operation is set at a low amount. <Fig. 8 >

Fig. 8

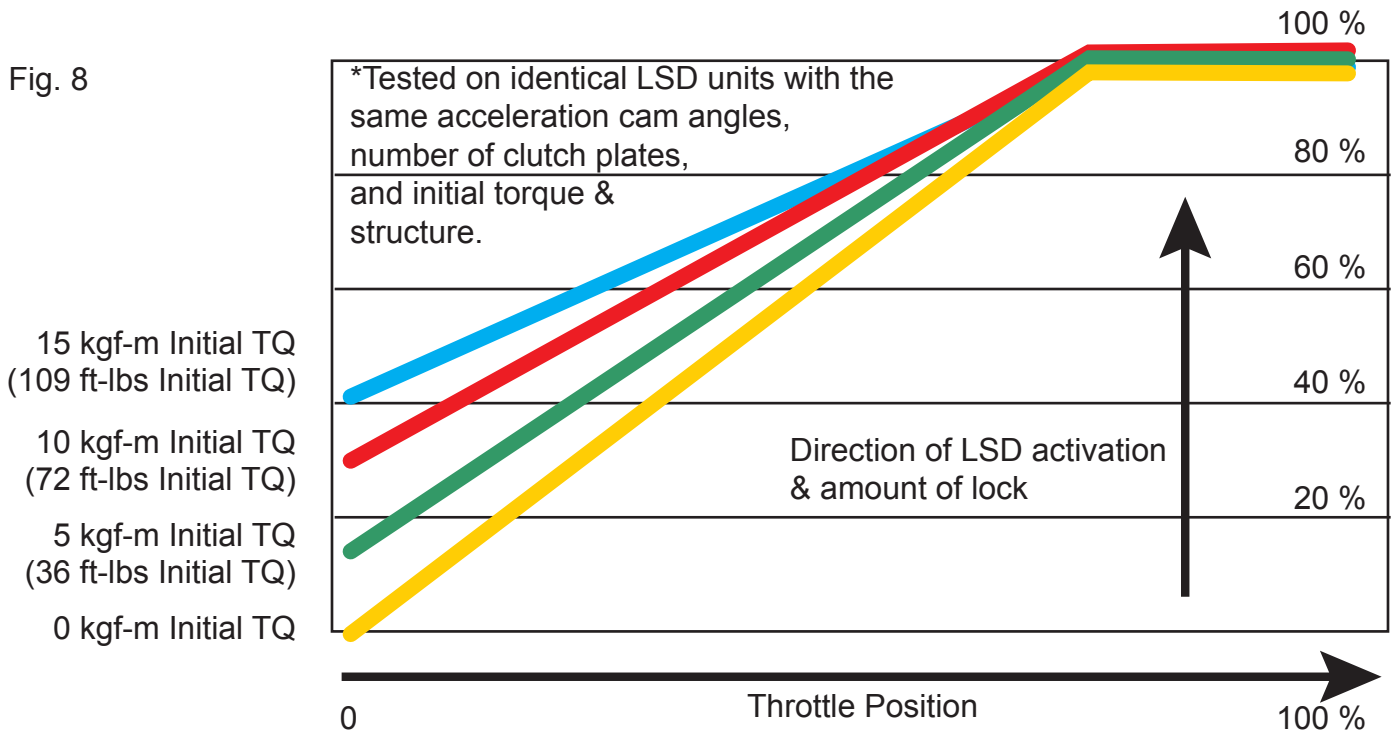

< Type RS, Type MZ, & Type Hybrid Structural Differences >

type-*RS*

type-*MZ*

**HYBRID
HD
IFF**

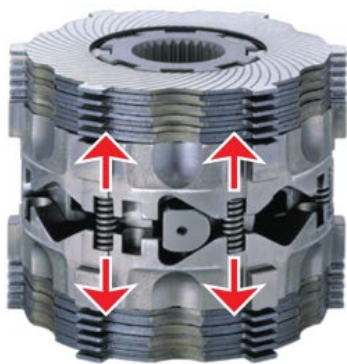
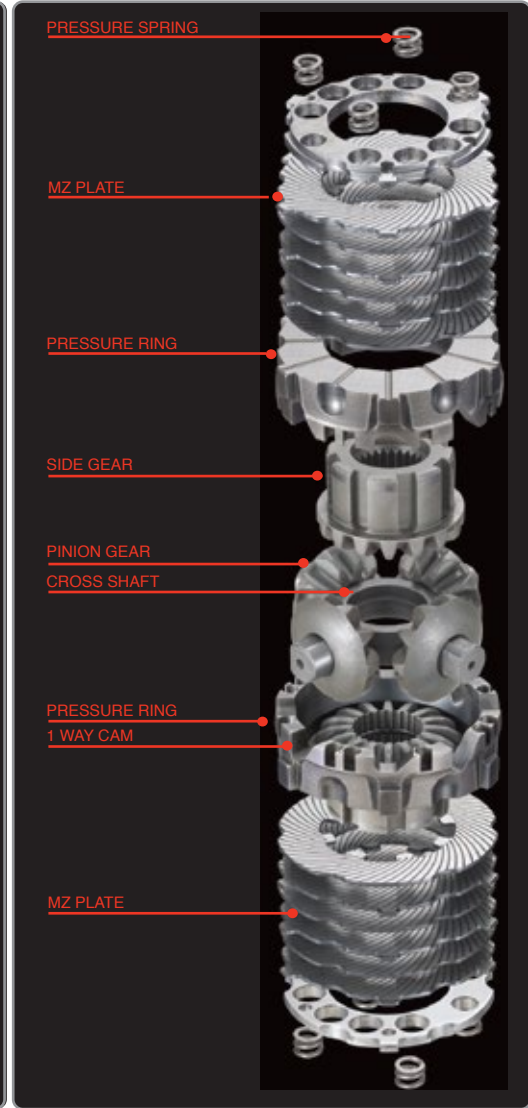
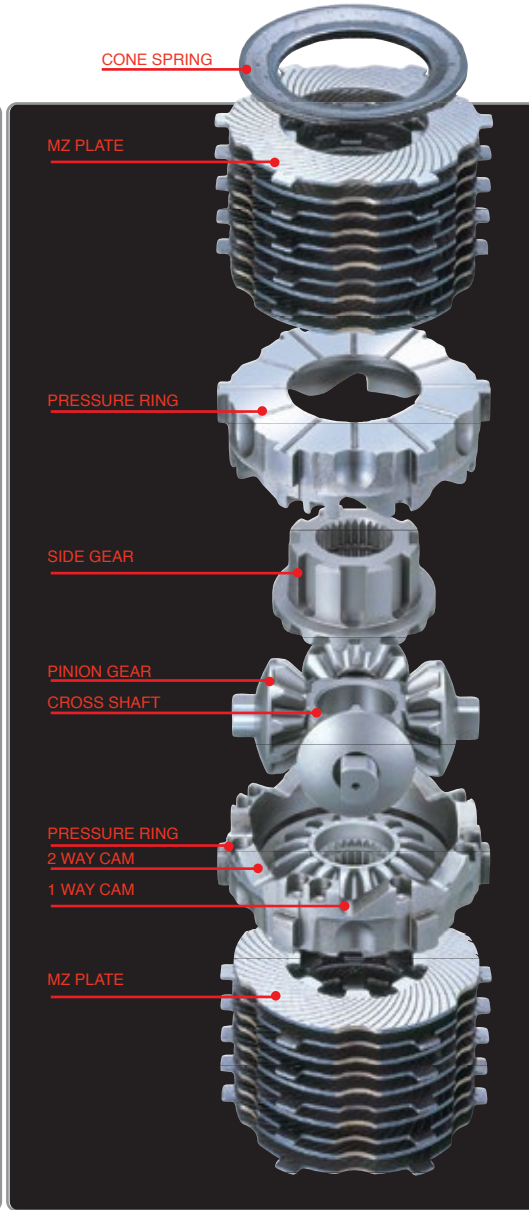
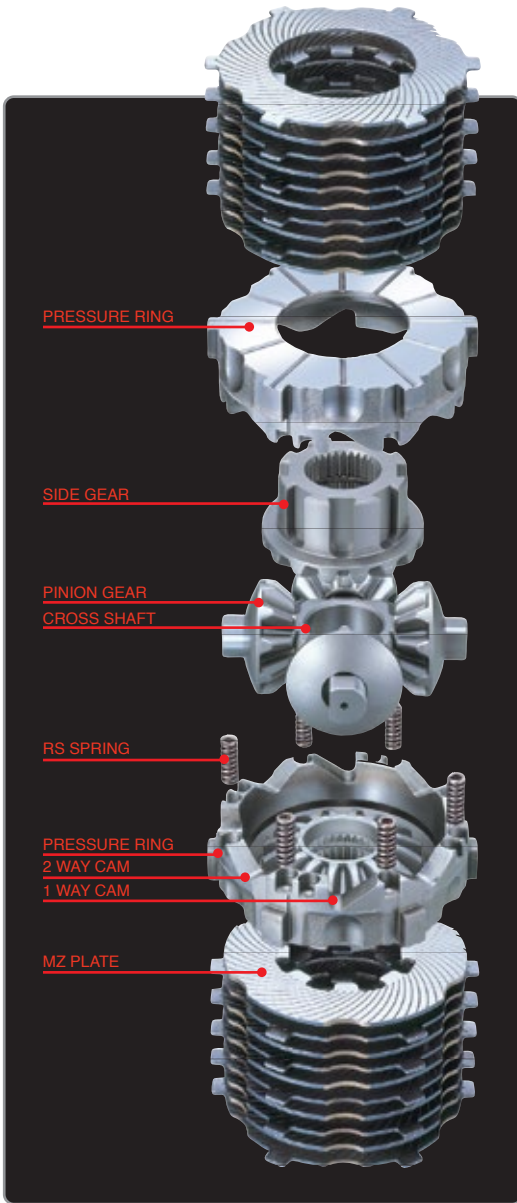

Type RS

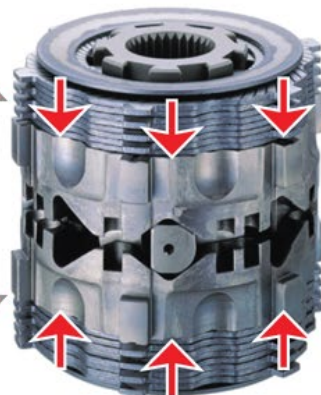

Type MZ



Type HYBRID



Differences in Initial Torque

The differences between the method of initial torque engagements between the Type RS and Type MZ were explained previously. This area explains more in-depth of the changes experienced between the two initial torque settings.

The Type MZ LSD has a higher initial torque setting than the Type RS & Hybrid LSD from the factory. The graph below displays the difference between the effects of the initial torque and the wear of the internal components (clutch disks). The data was taken from two identical vehicles and conditions, during an LSD overhaul.

Stronger load (pressure) is applied to the disks in the Type MZ since it is set at a high initial torque rating from the factory. Furthermore, the clutch disks and elasticity in the cone springs decrease faster, resulting in a shorter lifespan, compared to the RS & Hybrid. Overall, the Type MZ will require more overhaul (rebuild). <Fig. 9>

The pressure (load) applied to each clutch disk on the RS & Hybrid is weaker than the MZ model especially at its lowest initial torque setting and also when the LSD is not engaged. The coil springs apply the pressure to the clutch disks at all time, resulting in minimal loss of initial torque over time. The overhaul (rebuild) cycle is not as often as the MZ.

Fig. 9

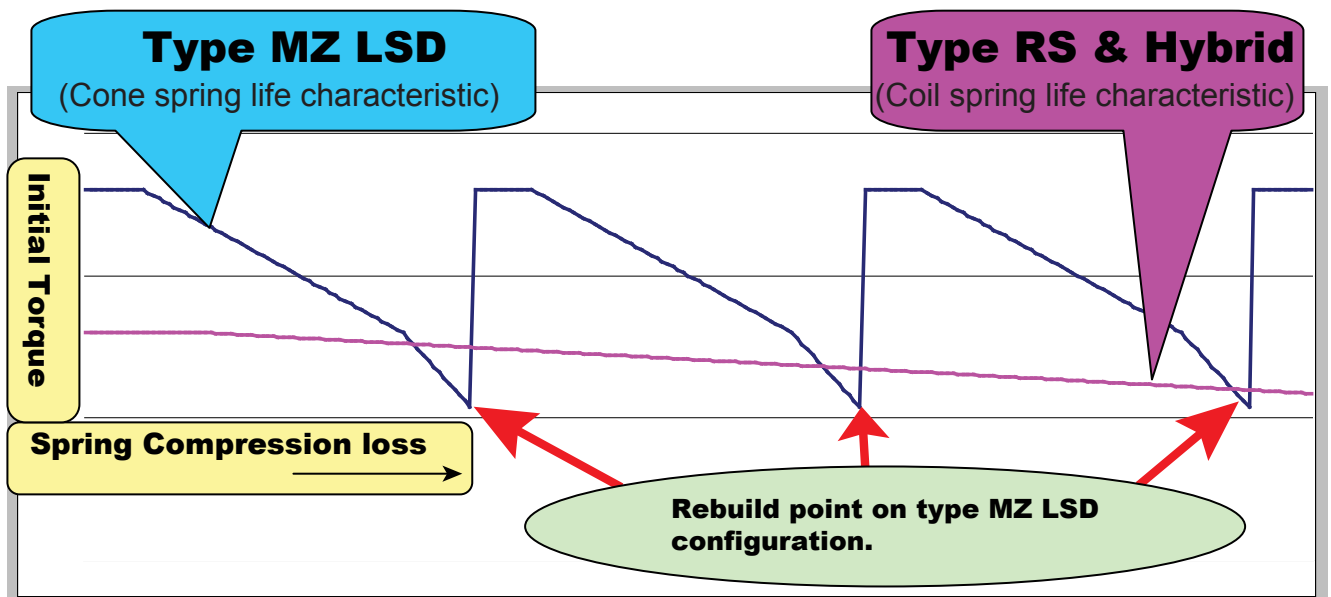

Torque Check SST

The SST (Special Service Tool) is necessary to check the initial torque. The spline ends are inserted into both ends of the LSD, then measured with a torque wrench. The initial torque can be set this way by changing the number of RS springs and/or thickness of the clutch plates used.



Results of Various Clutch Plate Quantity and Combination

The right combination of these tabbed clutch disks are responsible of how much response and lock the LSD exhibits. Type RS & MZ has maximum amount of clutch disks. Type Hybrid is 2-3 disks less than RS or MZ due to the thickness of the internal spring.

<Fig. 6>

LSDs having the most response and locking characteristics from the factory cannot be made to exceed the maximum output capacity.

*Applies to RS, MZ, & Hybrid.



The quantity of clutch plates have a great effect on the effectiveness (lock) of the LSD. On the same unit, the effectiveness begins to change with different contact patterns of the inner and outer tabbed disks.

(Each side having 10 plates, total of 20) <Fig. 10>

100% setting (Pressure Ring |in|out|in|out|in|out|in|out|in|out)

| = 10 frictional contact

80% setting (Pressure Ring |in|out|in|out|in|out|in-in|out-out)

| = 8 frictional contact

60% setting (Pressure Ring |in-in|out-out|in-in|out-out|in|out)

| = 6 frictional contact

* in-in & out-out refers to a single plate, 1 frictional contact

Fig. 10

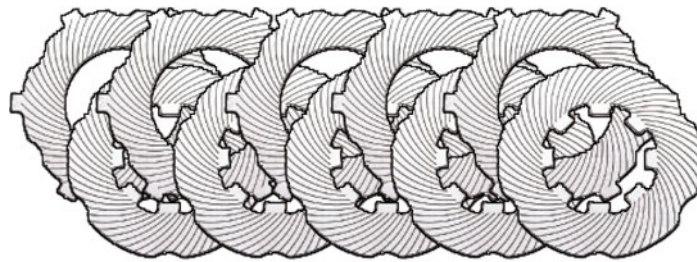

100 % setting

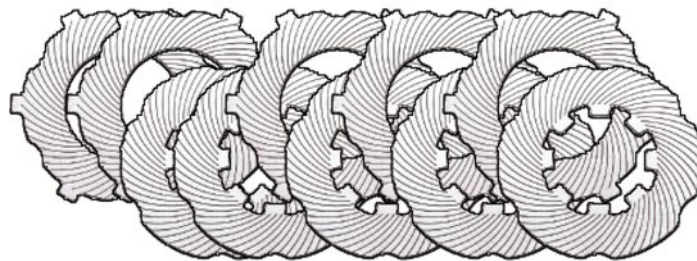

80 % setting

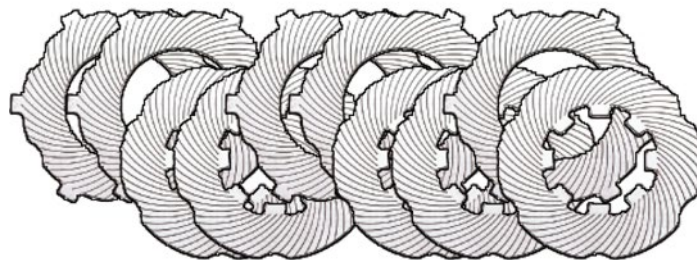

60 % setting

Cusco's Clutch disks (MZ plate) grooves are cut radially enabling instant oil movement, thus improving efficiency and durability. The pressure ring surfaces are polished for an even contact with the MZ plate and with Cusco's original design Oil Through system, it enhances the efficiency and performance of this LSD in comparison to other products available in the market. Thus, putting the Cusco LSD on top of the market in quality and championship winning results in an untouchable class of its own.

Fig. 11

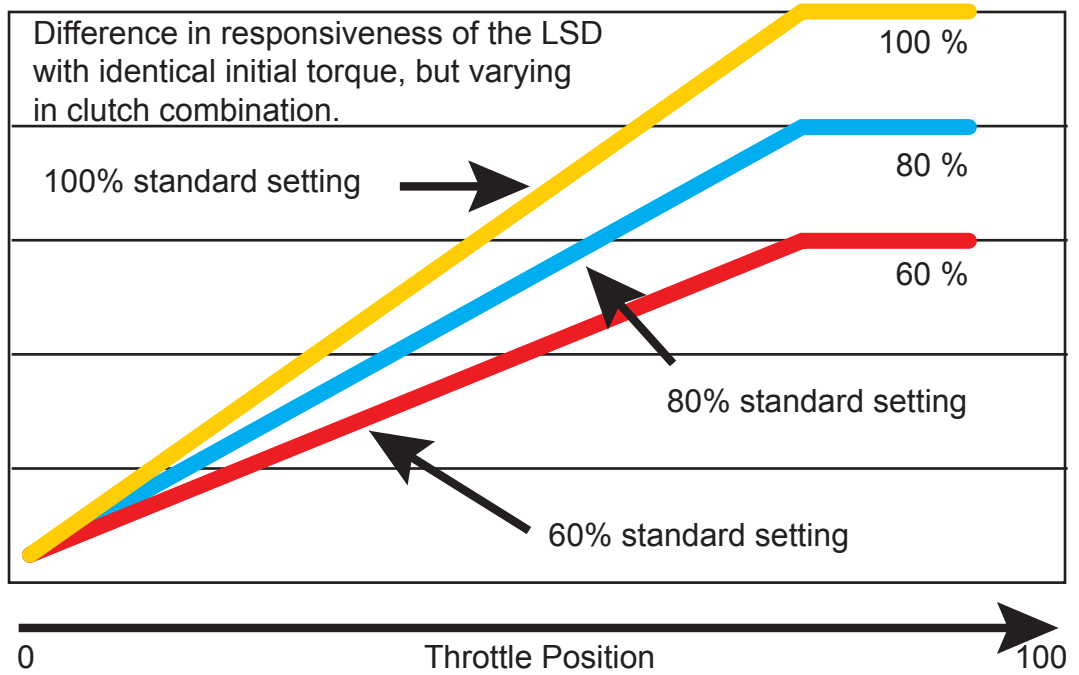

LSD Oil Change Interval

We recommend to change LSD oil following interval;

- After brake in the new LSD = 500 miles
- 1st LSD oil change = 3,000 miles
- 2nd LSD oil change = 10,000 miles
- Regular LSD oil change = Every 10,000 miles

***Applies to street driven applications only**



The Cam Angle

The amount of force required to push up the pressure ring depends on each shape of the cam, and how much angle it has.

On an LSD unit with the same initial torque and quantity of clutch plates, the effectiveness of the unit increases as the cam angle gets steeper from 35, 45, to 55 degrees. <Fig. 12 & 13 & 14>

Fig. 12

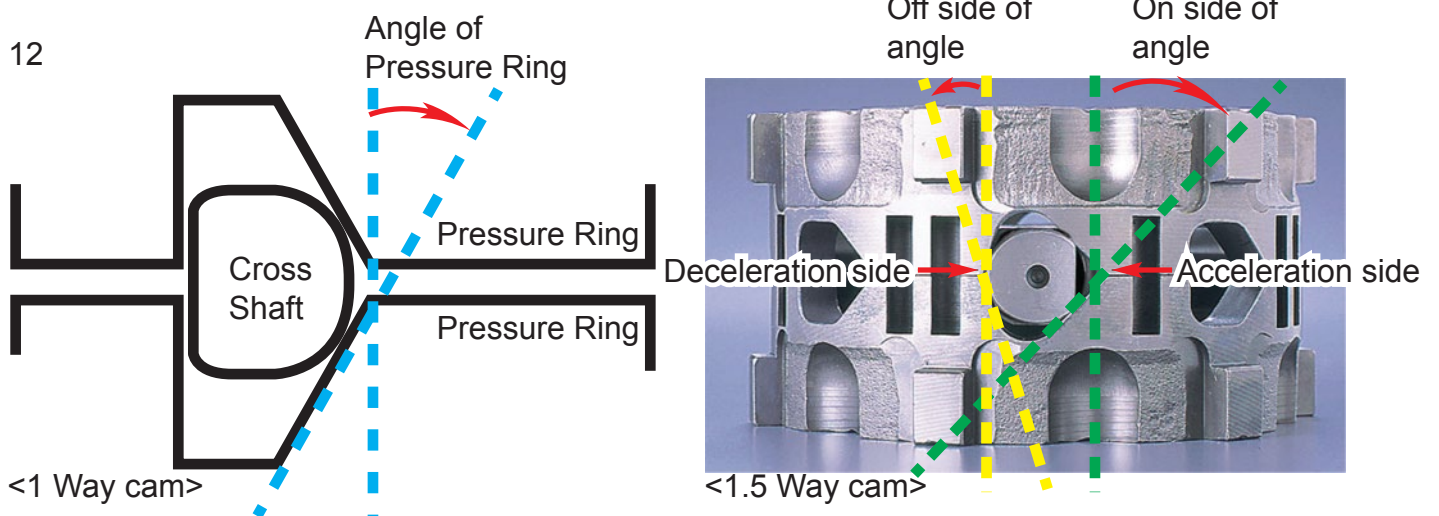

Fig. 13

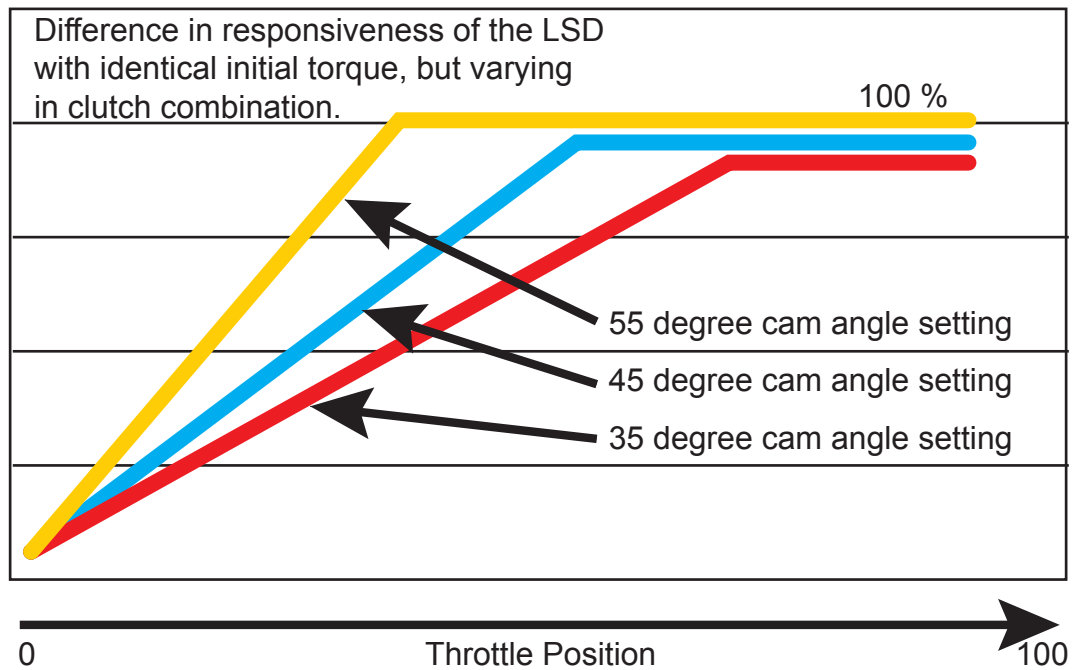

Fig. 14

Factory Cam Setting

Plate Size	Way	Cam Angle (1st & 2nd)
A size	1.5 Way & 2 Way	55 / 20 and 55 / 55
	1 Way & 2 Way	55 / 0 and 55 / 55
	1 Way	55 / 0 only (20pcs RS spring capacity)
	1 Way	35 / 0 and 45 / 0
B size	1.5 Way & 2 Way	55 / 20 and 55 / 55
	1 Way & 2 Way	35 / 0 and 55 / 55
	1 Way & 2 Way	45 / 0 and 45 / 45
	1 Way	35 / 0 and 45 / 0
	1 Way & 1.5 Way	35 / 0 and 50 / 15
C size	1 Way & 1.5 Way	45 / 0 and 45 / 15
	1.5 Way & 2 Way	55 / 20 and 55 / 55
	1 Way & 2 Way	55 / 0 and 55 / 55
	1 Way	35 / 0 and 45 / 0
	1 Way	55 / 0 only (24pcs RS spring capacity)
	1 Way	45 / 0 only (24pcs RS spring capacity)
D size	1 Way	35 / 0 and 45 / 0
	1 Way & 1.5 Way	45 / 0 and 55 / 20
	1 Way & 2 Way	45 / 0 and 45 / 45
	1.5 Way	35 / 20 and 45 / 20

Maintaining Stability and Performance

Cusco Oil Through System enables stability in high performance LSDs.

Cusco's advanced Oil Through System enables better oil flow inside the LSD for better efficiency. The casing made from Cusco's unique technology allows the oil to flow from the wide end to the pressure rings and the MZ clutch plate for efficient lubrication. Increased stability and durability is applied to the LSD because of this technology. This was only possible with Cusco's unique technology in manufacturing chro-moly steel casings and gears that enabled a higher level of durability and better flow of oil due to the large oil openings.

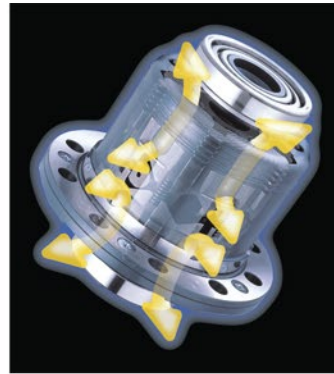

Improved Strength and Reliability

Highly resistant components manufactured with extreme efficiency in mind.

Cusco's Oil Through System is made possible by the adaptation of high quality chromoly steel. The precisely forged internal side and pinion gears enable a compact design, yet still durable for high power applications. This in turn increases the internal oil capacity as well as the number of MZ clutch plates taking the load off each plate for further durability.

LSD Oil

The base consists of a hybrid purified oil that maintains unhindered resistance against heat, even after extended usage. This oil can be used for all mechanical LSD units and is specially formulated by Cusco, providing minimal noise and vibration at a high performance level. The exclusive Cusco Friction Modifier additive is responsible for keeping down chatter and wear, which in turn maximizes the life of the LSD.

80W - 140

Specifically used for the rear LSD (rear 4WD & rear FR) which is more exposed to high loads and heat, especially on a high performance vehicle. This weight oil is well suited for usage in higher temperature regions and hot summers. Applies to all mechanical LSDs.

80W - 90

Good for use in FWD layout transmissions or AWD vehicles equipped with a limited slip. This multi-grade oil performs well even under extremely low/high temperatures. Also good for a wide range of use in all mechanical LSDs, from daily driving to full competition applications.



75W - 85

Contains a hybrid purified oil as its base. Synchronizer gears work at its ideal potential, saving unnecessary wear with the application of the special Friction Modifier additive. A smooth shift engagement mechanism can be experienced. Because of the Friction Modifier additive, this oil can now be used in FWD transmissions equipped with LSD units. The additive aids in extended life for the gear synchronizers and the limited slip performance. Even during cold climates, the 75W-85 assures effortless shifting and at the same time, the purified base oil still provides great performance against heat.



SMOOTH & MILD INITIAL ENGAGEMENT FOR THE TYPE RS & MZ

CUSCO LSD *type-RS* *type-MZ* SPEC-F New!

Type-RS SPEC-F / Type MZ SPEC-F

Most Applications Available

The Spec-F LSD feature a special flat friction clutch plates which translates to a milder initial engagement when acceleration is ON or OFF. This setup is perfect for rear wheel drive setups in circuit situations, as well as minimizing powerloss for low horsepower vehicles.

The key is the newly designed inner tabbed flat friction clutch plates combined with outer tabbed MZ plates enables a smooth and mild effectiveness when most needed.

Features

- Newly developed FFD (Flat Friction Disks)
- High precision polished disk surface for smooth and stable effect
- Smooth LSD engagement with mild features perfect for street use
- Metal disk materials provide stability from low to high temperature
- Cold forged high strength cold chromoly gears for endurance and longevity
- Spec-F FFD is swappable with any existing Type-RS & Type MZ LSD units. (FFD overhaul kits available)

Recommended For:

- ☆ Oversensitive LSDs during high speed cornering
- ☆ Time attack vehicles at a high speed track
- ☆ Minimize powerloss for underpowered vehicles
- ☆ More precise Mu control on wet surfaces
- ☆ High grip tires

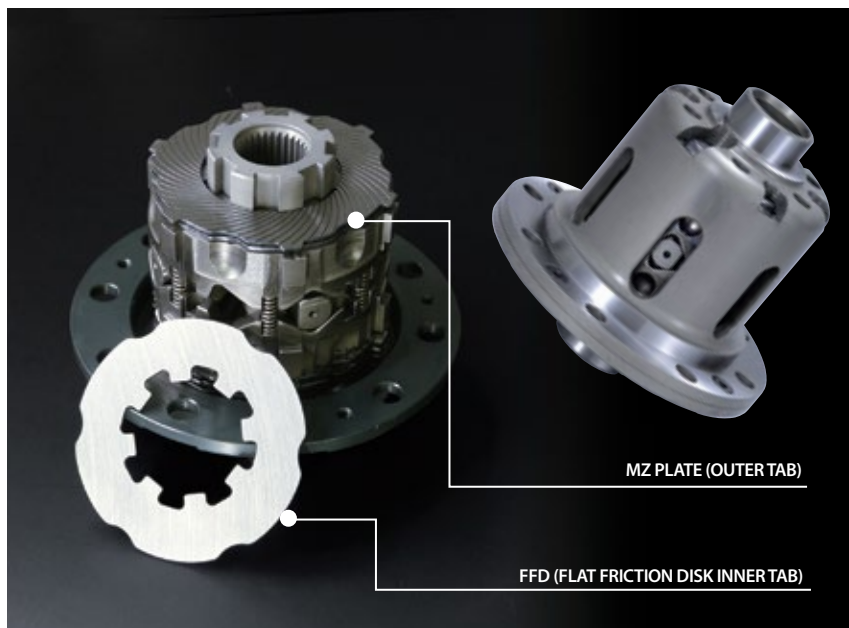
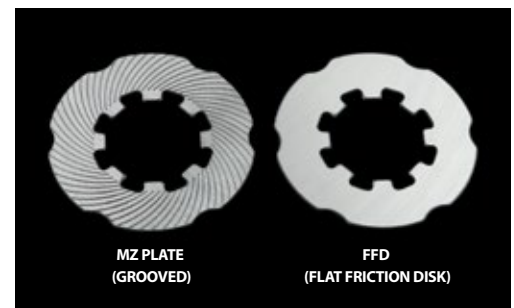

type-RS SPEC-F

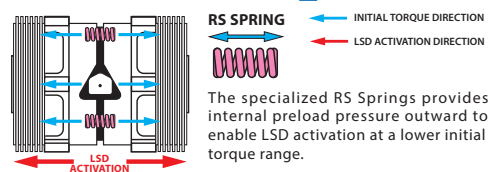

type-MZ SPEC-F

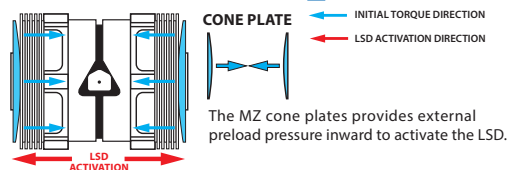

Each LSD unit comes with 2 types of profile setting

- | | | |
|------------------|------------|-------------------|
| FF VEHICLES ... | ○1&1.5 way | ○1way = Front |
| FR VEHICLES ... | ○1&2 way | ○1.5&2 way = Rear |
| 4WD VEHICLES ... | ○1&1.5 way | ○1way = Front |
| | ○1&2 way | ○1.5&2 way = Rear |

1 way comes with dual cam angle profiles to choose the initial sensitivity

PRO Adjust LSD

For professional & competition use, where even the slightest milliseconds count.

Specific cam angle and timing adjustment to a precise level. The larger the cam angle, the faster and stronger the LSD locks.

LSD can be modified to 1, 1.5, or 2 way by changing the cam chips.

The limited slip lock up timing also adjustable.

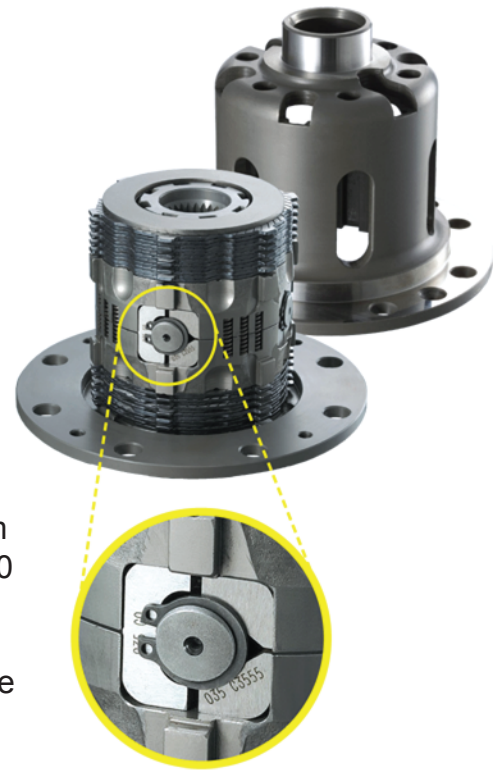

Cam angle is available from 0, 15, 25, 35, 45, 55, and 60 degree.

0 and 15 degree cam chips are for acceleration side use only.

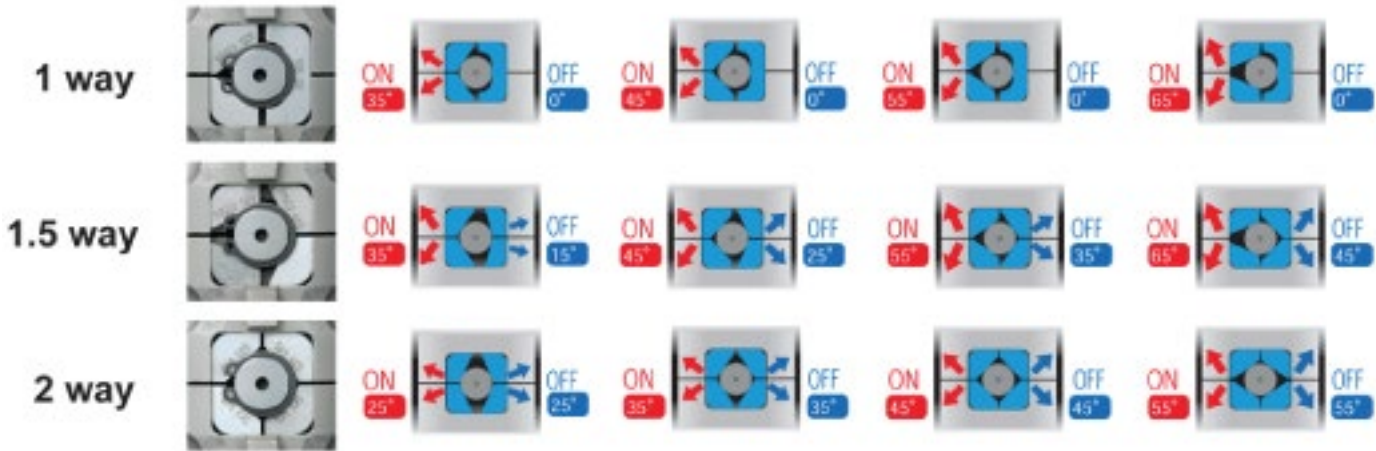
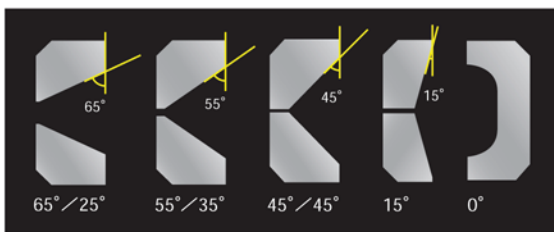

	Initial Torque	Number of Clutch disks	Direction of Initial Torque	Rebuild Cycle	Available Cam angle
Type RS	Low (Adjustable)	14 - 26 pcs	Same as Activation direction	Long	Choose from Factory setting
Type MZ	High (Adjustable)	12 - 26 pcs	Against to Activation direction	Short	Choose from Factory setting
Type Hybrid	Very Low (Adjustable)	10 - 22 pcs	Against to Activation direction	Longer	Choose from Factory setting
Pro Adjust	Adjustable	10 - 26 pcs	Adjustable	Depends on set up	Adjustable

CUSCO LSD Basic Part Number Designation

Part Number: LSD XXX X - Configuration No. (see chart below)

Type	Group	P/N (X)	Drive	Initial Setting	Accel/Decel Cam Angle	Initial Cam Setting	Remarks
TYPE-MZ (Cone SP)	A	A	FF	1-way	35/0 & 45/0	45/0	
		A2	AWD REAR & FR	1-way 2-way	55/0 & 55/55	55/0 55/55	
	B	B	FF	1-way	45/0 & 45/15	45/0	
		B15		1.5-way		45/15	
	BV	BV1	CN, CP9A Front	1-way	45/0 & 45/15	45/0	
		BV15		1.5-way		45/15	
	D	D	FF	1-way	35/0 & 45/0	45/0	
	E	E	FR	1-way	55/0 & 55/55	55/0	
		E2		2-way		55/55	
	EB	EB	FR	1-way	55/0 & 55/55	55/0	
		EB2	with side bearings	2-way		55/55	
	K	K15	FR	1.5-way	55/20 & 55/55	55/20	
		K2		2-way		55/55	
	KB	K15B	FR	1.5-way	55/20 & 55/55	55/20	
K2B		with side bearings	2-way		55/55		
TYPE-RS (Coil SP)	C	C	FF	1-way	45/0 & 45/15	45/0	
		C15		1.5-way		45/15	
	CV	CV1	CN, CP9A Front	1-way	45/0 & 45/15	45/0	
		CV115		1.5-way		45/15	
		CV2		1-way		45/0	
		CV215		1.5-way		45/15	
	F	F	FF	1-way	35/0 & 45/0	45/0	
		F2	AWD REAR & FR	1-way 2-way	55/0 & 55/55	55/0 55/55	
	FB	FB	FR	1-way	55/0 & 55/55	55/0	
		FB2	with side bearings	2-way		55/55	
	FV	FV1	CN, CP9A Front	1-way	35/0 & 45/0	35/0	
		FV2		1-way		35/0	
	FG	FG	FF COMP SPEC	1-way	45/0	45/0	RS Spring: 16 pcs. (Max. 24 pcs.)
			AWD REAR COMP SPEC	1-way	55/0	55/0	RS Spring: 24 pcs.
	FD	FD	DRAG RACING	1-way	55/0	55/0	RS Spring: 12 pcs. (Max. 20 pcs.)
	FR	FR	RALLY, GRAVEL	1-way	45/0 & 55/0	45/0	
	L	L15	FR	1.5-way	55/20 & 55/55	55/20	
		L2		2-way		55/55	
LB	L15B	FR	1.5-way	55/20 & 55/55	55/20		
	L2B	with side bearings	2-way		55/55		