

# 12064 DODGE CHARGER & CHALLENGER, CHRYSLER 300 & 300S

GROSS LOAD CAPACITY WHEN USED AS A WEIGHT CARRYING HITCH: 3,500 LBS. TRAILER WEIGHT & 350 LBS. TONGUE WEIGHT.

**\*\*\*DO NOT EXCEED VEHICLE MANUFACTURER'S RECOMMENDED TOWING CAPACITY.\*\*\***

**WARNING: ALL NON-TRAILER LOADS APPLIED TO THIS PRODUCT MUST BE SUPPORTED BY 18050 STABILIZING STRAPS.**

**\*\* FAILURE TO PROPERLY SUPPORT NON-TRAILER LOADS WILL VOID PRODUCT WARRANTY\*\***

Parts List			
ITEM	QTY	PART NUMBER	DESCRIPTION
1	3	1_2 FISHWIRE	1/2" FISHWIRE
2	3	M12-1.75 x 40mm	HEX BOLT
3	3	1/2"	CONICAL TOOTHED WASHER
4	3	HFN 1213	HEX FLANGE NUT
5	3	CM-SP40	.188 x 1.00 x 3.00" SQUARE HOLE SPACER
6	3	1/2-13 x 1 3/4	CARRIAGE BOLT

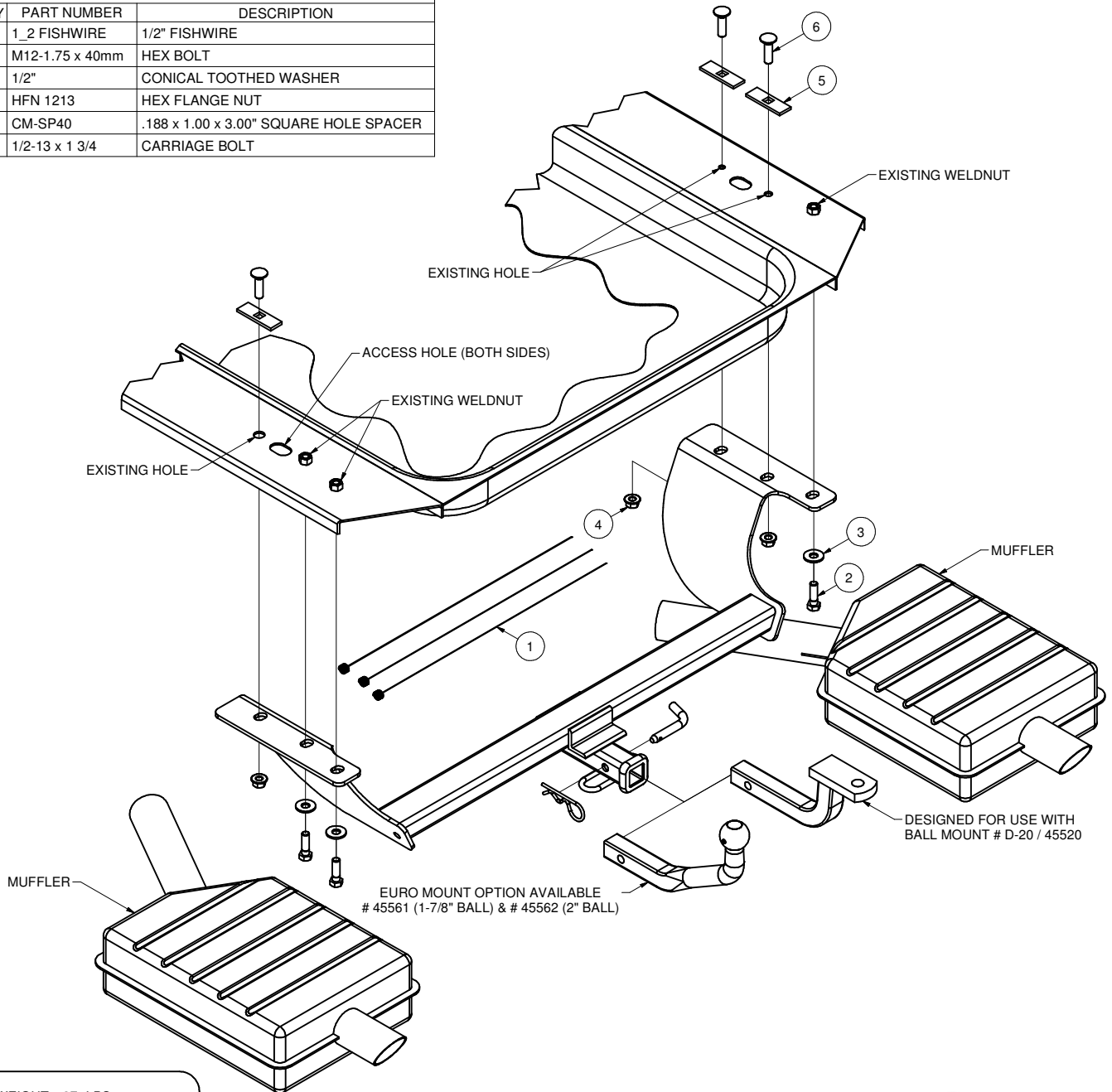

**HITCH WEIGHT:** .37 LBS.

**INSTALL TIME**

PROFESSIONAL: 45 MINUTES

NOVICE (DIY): 90 MINUTES

**INSTALL NOTES:**

- LOWER EXHAUST
- FISHWIRE HARDWARE
- REMOVE DRIVER SIDE MUFFLER
- NO DRILLING REQUIRED

**PERIODICALLY CHECK THIS RECEIVER HITCH TO ENSURE THAT ALL FASTENERS ARE TIGHT AND THAT ALL STRUCTURAL COMPONENTS ARE SOUND.**

# 12064 DODGE CHARGER & CHALLENGER, CHRYSLER 300 & 300S

## FISHWIRE TECHNIQUE

INSERT COILED END OF FISHWIRE TOOL THROUGH HITCH MOUNTING HOLE IN VEHICLE FRAME RAIL AND OUT THE ACCESS HOLE. PASS COILED END OF FISHWIRE THROUGH SPACER AND THREAD BOLT INTO COIL. KINK WIRE TO KEEP SPACER SEPARATE FROM BOLT AS SHOWN. PULL FISHWIRE, SPACER, AND BOLT THROUGH FRAME AND OUT MOUNTING HOLE. USE FISHWIRE TO GUIDE HITCH DURING MOUNTING AND PREVENT LOSS OF BOLT / SPACER INSIDE FRAME RAIL.

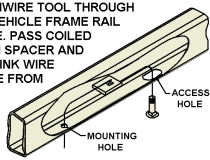

\*\*NOTE: SOME VEHICLES MAY FISHWIRE THROUGH END OF FRAME\*\*

## RUBBER ISOLATOR REMOVAL DIAGRAM

This technique can be used if and Exhaust Hanger Removal Pliers is not available.

Using a 5/8" open end wrench, slide the wrench up to the rubber isolator, cradling the hanger rod as shown. Next place the flat edge of a pry bar between the wrench and the hanger stop or hanger rod. Then simply rotate the pry bar toward the wrench to remove the rubber isolator.

Note: Using a spray lubricant or soapy water on the hanger rod and the rubber isolator helps removal.

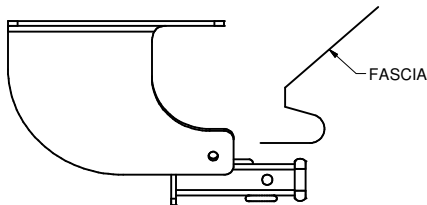
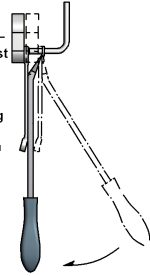

INSTALLED HITCH POSITION

## TOOLS REQUIRED

RATCHET
TORQUE WRENCH
6" SOCKET EXTENSION
SOCKET UNIVERSAL JOINT
13mm SOCKET
15mm SOCKET
19mm SOCKET
3/4" SOCKET

## INSTALLATION STEPS

1. Locate and remove (2) exhaust isolators near muffler on driver and passenger side of vehicle. Save bolts for reinstallation.
2. Locate and remove (2) rubber isolators from exhaust pipe. (See RUBBER ISOLATOR REMOVAL DIAGRAM)
3. On V6 models: Locate and remove nut from exhaust clamp that holds the driver side muffler. Save nut for reinstallation.  
On V8 models: Locate and remove (2) nuts with springs attaching driver side muffler. Save nuts and springs for reinstallation.
4. Slide and remove driver side muffler/tube off of remaining exhaust system.
5. Fishwire 1/2" carriage bolts and CM-SP40 spacers through access hole on driver and passenger side frame rail. Pull hardware through existing holes (2 on passenger side and 1 on driver side). (See FISHWIRE TECHNIQUE diagram.)
6. Raise hitch into position by placing passenger side of hitch over the passenger side muffler first and then raise the driver side of hitch.
7. Secure hitch with supplied M12 hardware and conical toothed washers. Attach 1/2" hex flange nuts onto carriage bolts.
8. Torque 1/2" hardware to 110 lb-ft and M12 hardware to 79 lb-ft.
9. On V6 Models: Slide driver side muffler/tube back into position against stud on exhaust system. Secure clamp with nut from Step 3.  
On V8 Models: Reattach driver side muffler onto studs with nuts and springs from Step 3.
10. Raise exhaust back into position and reattach (2) exhaust isolators.
11. Reinstall (4) exhaust hangers from Step 1.

**PERIODICALLY CHECK THIS RECEIVER HITCH TO ENSURE THAT ALL FASTENERS ARE TIGHT AND THAT ALL STRUCTURAL COMPONENTS ARE SOUND.**



# 12064 INSTALLATION INSTRUCTIONS

**!** Safety glasses should be worn at all times while installing this product.

**YEARS:** 2011-PRESENT

**MAKE:** DODGE / CHRYSLER

**MODEL:** CHARGER / CHALLENGER / 300 / 300S







**STYLE:** SEDAN / COUPE

**WARNING: NEVER EXCEED YOUR VEHICLE MANUFACTURER'S RECOMMENDED TOWING CAPACITY**

**WEIGHT CARRYING:**  
**TRAILER WEIGHT:** 3,500 LBS.  
**TONGUE WEIGHT:** 350 LBS.

**INSTALLATION TIME: 45 MIN.**  
 THE INSTALL TIME LISTED IS FOR PROFESSIONAL INSTALLERS. IF YOU ARE HESITANT TO UNDERTAKE THIS TASK ON YOUR OWN, CONTACT AN AUTHORIZED CURT INSTALLER FOR ADDITIONAL ASSISTANCE.





**INSTALLATION REQUIRES:**

 <b>RATCHET</b>	 <b>TORQUE WRENCH</b>	 <b>6"</b> <b>SOCKET EXTENSION</b>
 <b>UNIVERSAL JOINT SOCKET</b>	 <b>13mm</b> <b>15mm</b> <b>19mm</b> <b>3/4"</b> <b>SOCKET</b>	 <b>SAFETY GLASSES</b>

**INSTALLATION TIPS:**

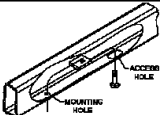
- BEFORE YOU BEGIN INSTALLATION, READ ALL INSTRUCTIONS THOROUGHLY.
- TO EASE INSTALLATION, 2 PEOPLE MAY BE REQUIRED.
- USING PROPER TOOLS WILL GREATLY IMPROVE THE QUALITY OF THE INSTALL AND REDUCE THE TIME REQUIRED.

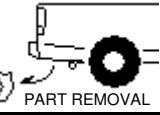
**LEVEL OF DIFFICULTY: MODERATE**

<i>EASY</i>	<i>MODERATE</i>	<i>CHALLENGING</i>
	FISHWIRE HARDWARE	
	REMOVE EXHAUST ISOLATORS	
	REMOVE DRIVER SIDE MUFFLER	
	NO DRILLING REQUIRED	

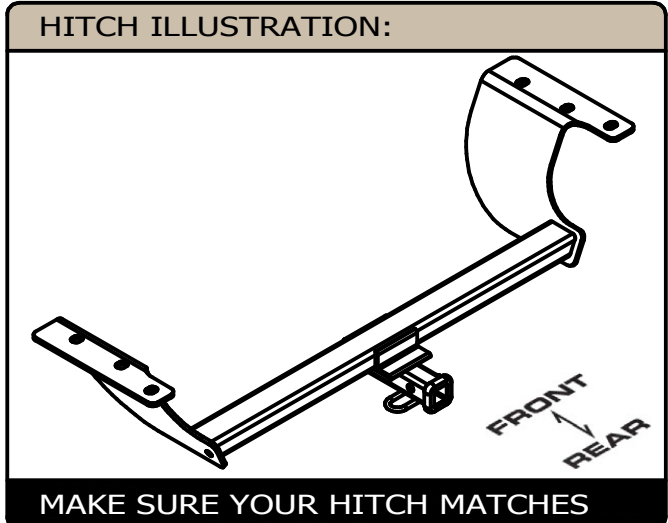

**PERIODICALLY CHECK THIS RECEIVER HITCH TO ENSURE ALL FASTENERS ARE TIGHT AND ALL STRUCTURAL COMPONENTS ARE SOUND**  
 CURT Manufacturing LLC. warrants this product to be free of defects in material and/or workmanship at the time of retail purchase by the original purchaser. If the product is found to be defective, Curt Manufacturing LLC. may repair or replace the product at their option, when the product is returned, prepaid, with proof of purchase. Alteration to, misuse of, or improper installation of this product voids the warranty. Curt Manufacturing LLC.'s liability is limited to repair or replacement of products found to be defective, and specifically excludes liability for incidental or consequential loss or damage.

## INSTALLATION WALKTHROUGH:

Parts List			
ITEM	QTY	PART NUMBER	DESCRIPTION
1	3	1_2 FISHWIRE	1/2" FISHWIRE
2	3	M12-1.75 x 40mm	HEX BOLT
3	3	1/2"	CONICAL TOOTHED WASHER
4	3	HFN 1213	HEX FLANGE NUT
5	3	CM-SP40	.188 x 1.00 x 3.00" SQUARE HOLE SPACER
6	3	1/2-13 x 1 3/4	CARRIAGE BOLT

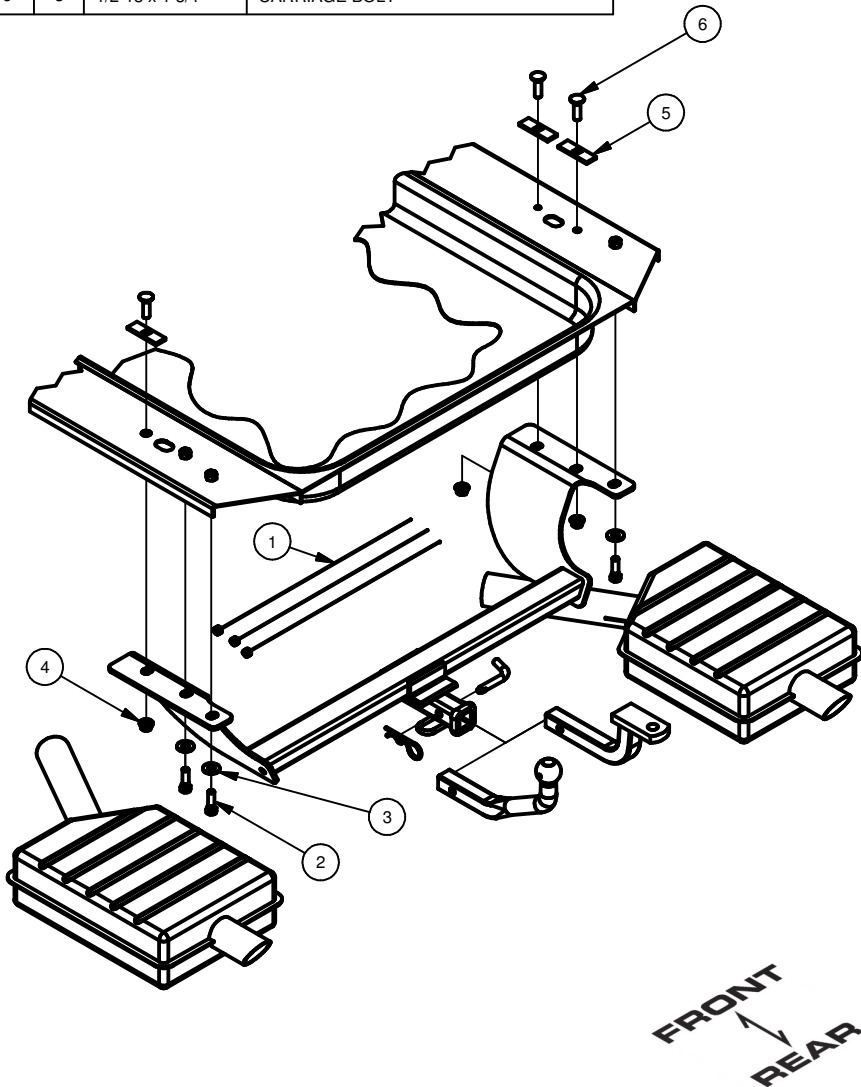

1. Locate and remove (2) exhaust isolators near muffler on driver and passenger side of vehicle. Save bolts for reinstallation.



2. Locate and remove (2) rubber isolators from exhaust pipe.



## INSTALLATION WALKTHROUGH:

3. On V6 models: Locate and remove nut from exhaust clamp that holds the driver side muffler. Save nut for reinstallation.

On V8 models: Locate and remove (2) nuts with springs attaching driver side muffler. Save nuts and springs for reinstallation.

Slide and remove driver side muffler/tube off of remaining exhaust system.

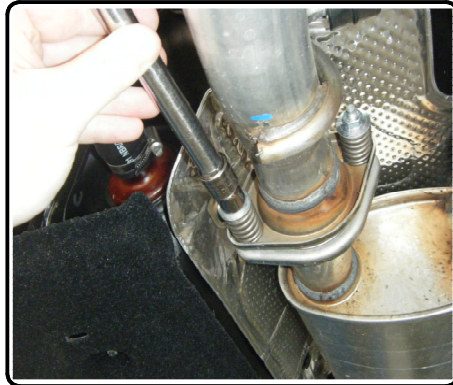

4. Fishwire 1/2" carriage bolts and CM-SP40 spacers through access hole on driver and passenger side frame rail. Pull hardware through existing holes (2 on passenger side and 1 on driver side).

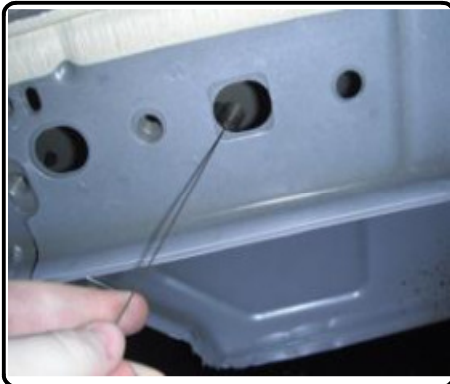

5. Raise hitch into position by placing passenger side of hitch over the passenger side muffler first and then raise the driver side of hitch. Secure hitch to existing weldnuts with supplied M12 hardware and conical toothed washers. Attach 1/2" hex flange nuts onto carriage bolts.

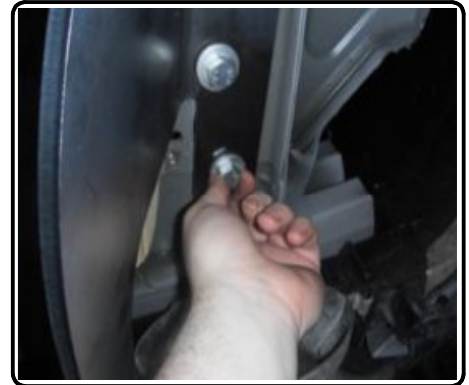

6. Torque 1/2" hardware to 110 lb-ft and M12 hardware to 79 lb-ft.



## INSTALLATION WALKTHROUGH:

7. On V6 Models: Slide driver side muffler/tube back into position against stud on exhaust system. Secure clamp with nut from Step 3.
- On V8 Models: Reattach driver side muffler onto studs with nuts and springs from Step 3.

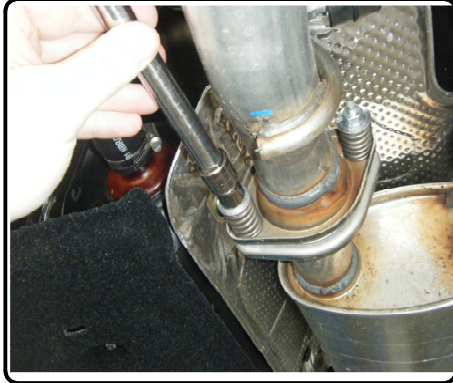

8. Raise exhaust back into position and reattach (2) exhaust isolators. Reinstall (4) hangers removed in Step 1.

