



# 11002 INSTALLATION INSTRUCTIONS



Safety glasses should be worn at all times while installing this product.

YEARS: 2010 - CURRENT

MAKE: HONDA

MODEL: ACCORD CROSSTOUR

STYLE: CROSSOVER







**WARNING: NEVER EXCEED YOUR VEHICLE MANUFACTURER'S RECOMMENDED TOWING CAPACITY**

**WEIGHT CARRYING:**  
TRAILER WEIGHT: 2,000 LBS.  
TONGUE WEIGHT: 200 LBS.

**INSTALLATION TIME: 30 MIN.**

THE INSTALL TIME LISTED IS FOR PROFESSIONAL INSTALLERS. IF YOU ARE HESITANT TO UNDERTAKE THIS TASK ON YOUR OWN, CONTACT AN AUTHORIZED CURT INSTALLER FOR ADDITIONAL ASSISTANCE.



### INSTALLATION REQUIRES:

 <b>SOCKETS</b>	 <b>SOCKET EXTENSION</b>	 <b>RATCHET</b>
 <b>PRY BAR</b>	 <b>TORQUE WRENCH</b>	 <b>AVIATION SHEARS</b>

### INSTALLATION TIPS:

- BEFORE YOU BEGIN INSTALLATION, READ ALL INSTRUCTIONS THOROUGHLY.
- TO EASE INSTALLATION, 2 PEOPLE MAY BE REQUIRED.
- USING PROPER TOOLS WILL GREATLY IMPROVE THE QUALITY OF THE INSTALL AND REDUCE THE TIME REQUIRED.

### LEVEL OF DIFFICULTY: MODERATE

EASY	MODERATE	HARD
	<b>NO DRILLING REQUIRED</b>	
	<b>HEAT SHIELD TRIMMING REQUIRED</b>	
	<b>RUBBER ISOLATOR REMOVAL REQUIRED</b>	

### VEHICLE PHOTO:



REPRESENTATIVE PHOTO

### HITCH ILLUSTRATION:

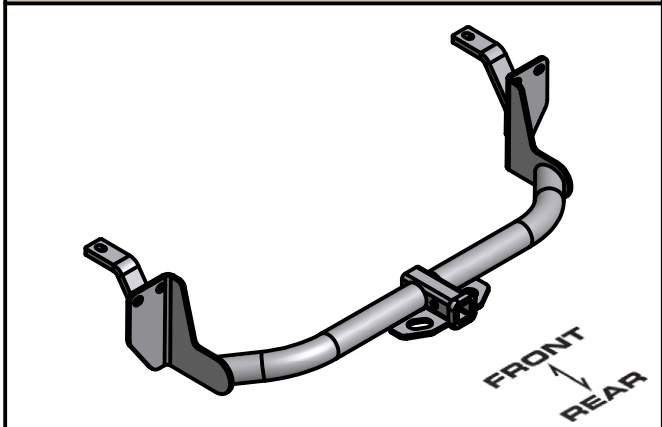

MAKE SURE YOUR HITCH MATCHES

**PERIODICALLY CHECK THIS RECEIVER HITCH TO ENSURE ALL FASTENERS ARE TIGHT AND ALL STRUCTURAL COMPONENTS ARE SOUND**

CURT Manufacturing Inc. warrants this product to be free of defects in material and/or workmanship at the time of retail purchase by the original purchaser. If the product is found to be defective, Curt Manufacturing Inc. may repair or replace the product at their option, when the product is returned, prepaid, with proof of purchase. Alteration to, misuse of, or improper installation of this product voids the warranty. Curt Manufacturing Inc.'s liability is limited to repair or replacement of products found to be defective, and specifically excludes liability for incidental or consequential loss or damage.

# INSTALLATION WALKTHROUGH:

PARTS LIST			
ITEM	QTY	PART NUMBER	DESCRIPTION
1	2	7/16-14 x 1 1/2	HEX BOLT
2	2	3/8"	WASHER
3	2	7/16-14	HEX FLANGE NUT
4	2	M8-1.25 x 35	HEX BOLT
5	2	5/16"	LOCK WASHER
6	2	5/16"	WASHER
7	2	M10-1.25 x 35	HEX BOLT
8	2	3/8"	CONICAL TOOTHED WASHER

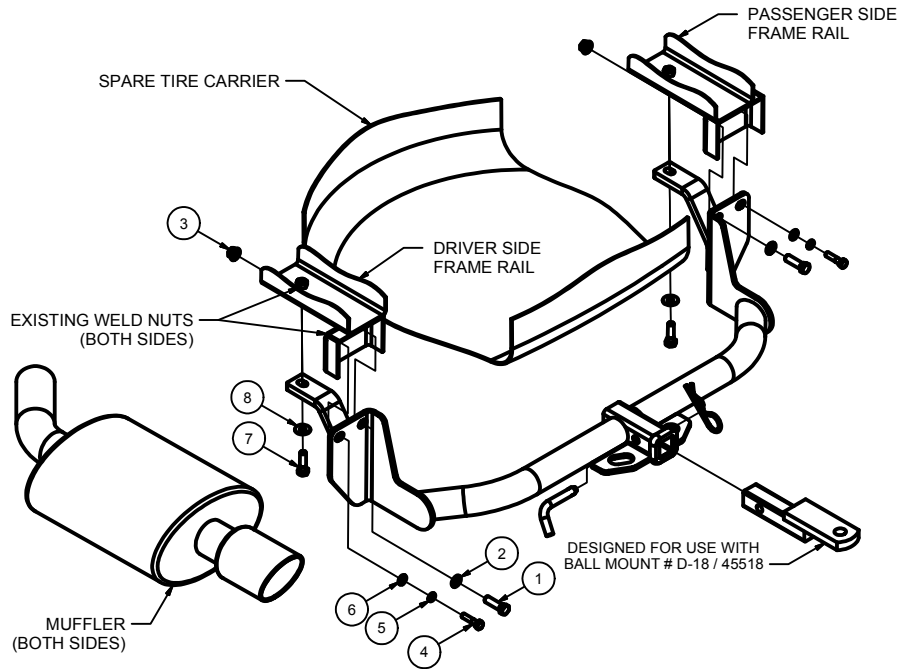

1. Lower the exhaust by removing the (3) rear most rubber isolators on each side of the exhaust. Gently spread the exhaust to allow the mufflers to pass by the spare tire carrier. Support the exhaust system to prevent damage. (See Rubber Isolator Removal Diagram.)



**RUBBER ISOLATOR REMOVAL DIAGRAM**

This technique can be used if an Exhaust Hanger Removal Pliers is not available.

Using a 5/8" open end wrench, slide the wrench up to the rubber isolator, cradling the hanger rod as shown. Next place the flat edge of a pry bar between the wrench and the hanger stop or hanger rod. Then simply rotate the pry bar toward the wrench to remove the rubber isolator.

Note: Using a spray lubricant or soapy water on the hanger rod and the rubber isolator helps removal.

2. Remove the existing M8 bolt from the bottom of the bumper support on each side of the vehicle. Return the bolts to the vehicle owner.

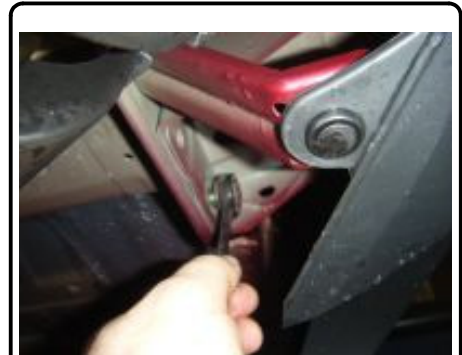

## INSTALLATION WALKTHROUGH:

3. Remove the (3) bolts securing each heat shield and remove the heat shields from the vehicle. Trim the heat shields as shown below and reinstall.

APPROXIMATE AREA TO TRIM

4 in

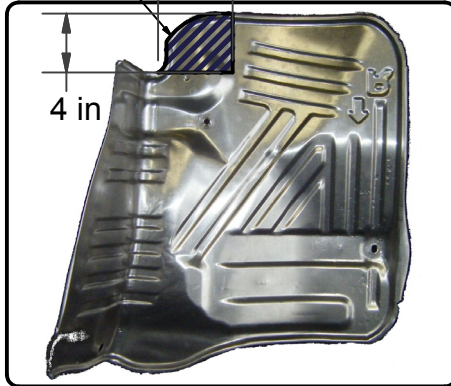

4. Raise the hitch into position and loosely secure it to the frame rails using M10 hex bolts and conical toothed washers into the existing weld nuts as shown.

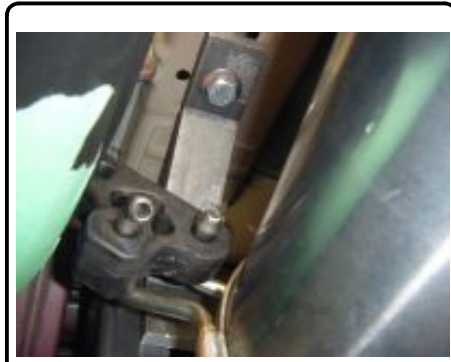
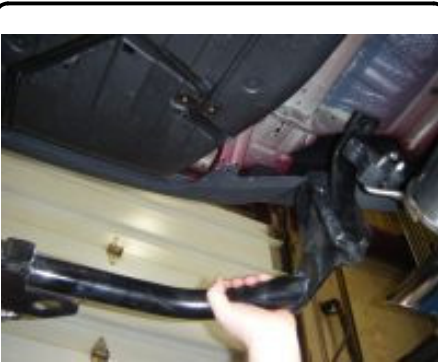

5. Secure the hitch to the lower bumper support using a M8 hex bolt, 5/16" lock washer and 5/16" flat washer into the existing weld nut on both sides as shown. Insert the 7/16" hex bolts with 3/8" flat washers into the existing holes as shown and secure with 7/16 hex flange nuts.



6. Torque:
- All M8 hardware to 17 ft-lbs.
  - All M10 hardware to 37 ft-lbs.
  - All 7/16" hardware to 50 ft-lbs.

7. Raise the exhaust into position and reinstall rubber isolators removed in Step 1. (Installation is complete.)



11002

HONDA ACCORD CROSSTOUR

GROSS LOAD CAPACITY WHEN USED AS A WEIGHT CARRYING HITCH: 2,000 LBS. TRAILER WEIGHT & 200 LBS. TONGUE WEIGHT.

\*\*\*DO NOT EXCEED VEHICLE MANUFACTURER'S RECOMMENDED TOWING CAPACITY.\*\*\*

WARNING: ALL NON-TRAILER LOADS APPLIED TO THIS PRODUCT MUST BE SUPPORTED BY AUXILIARY STABILIZING STRAPS.

Parts List			
ITEM	QTY	PART NUMBER	DESCRIPTION
1	2	7/16-14 x 1 1/2	HEX BOLT
2	2	3/8"	WASHER
3	2	7/16-14	HEX FLANGE NUT
4	2	M8-1.25 x 35	HEX BOLT
5	2	5/16"	LOCK WASHER
6	2	5/16"	WASHER
7	2	M10-1.25 x 35	HEX BOLT
8	2	3/8"	CONICAL TOOTHED WASHER

TOOLS REQUIRED
PRY BAR
10, 13, 14 AND 16mm SOCKETS
13, 14, AND 16mm WRENCHES
3" EXTENSION
RATCHET
TORQUE WRENCH
AVIATOR SHEARS

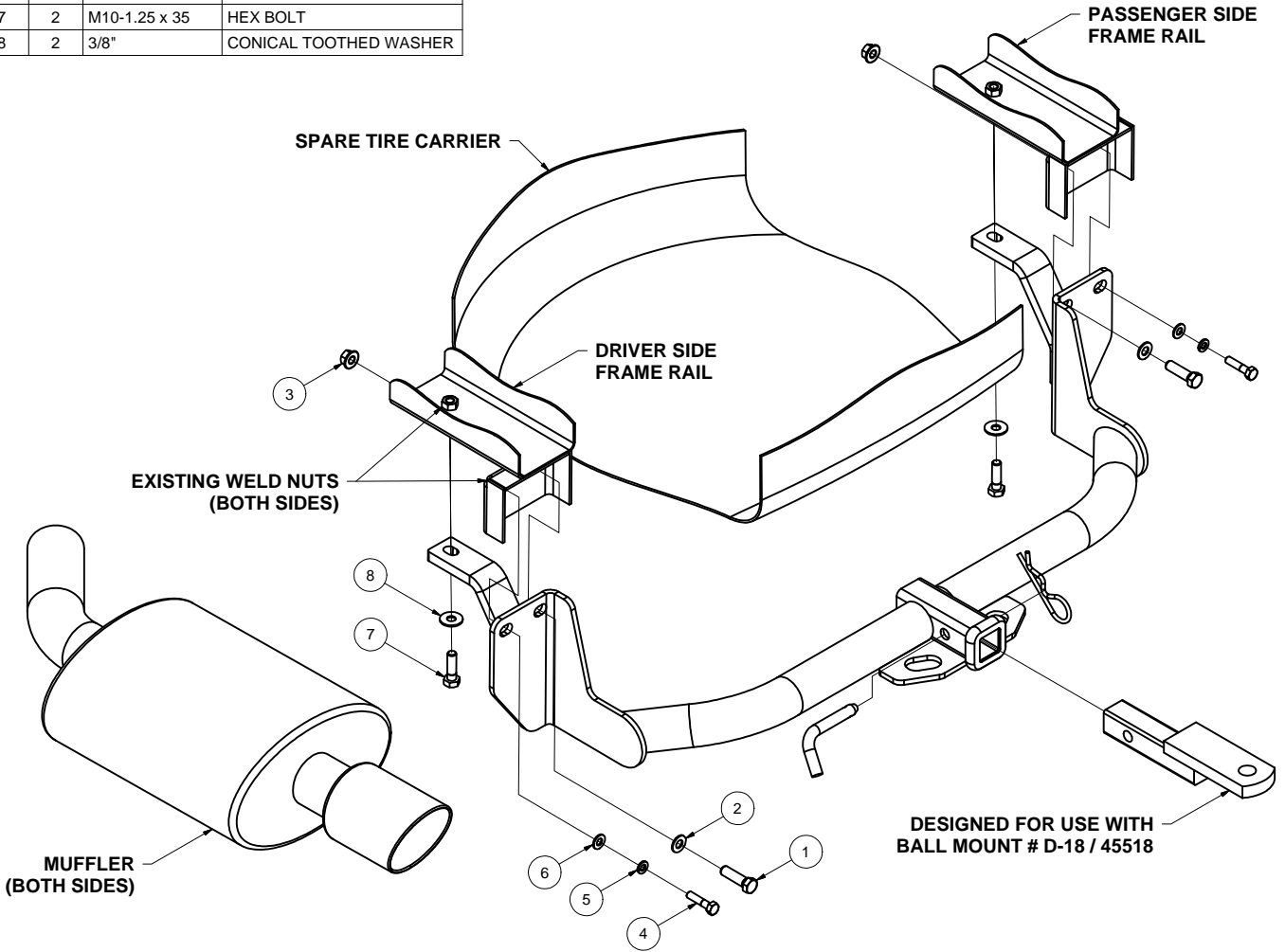

HITCH WEIGHT: .26 LBS.  
 INSTALL TIME  
 PROFESSIONAL: 30 MINUTES  
 NOVICE (DIY): 60 MINUTES  
 INSTALL NOTES:  
 - LOWER EXHAUST  
 - TRIM HEAT SHIELDS



PERIODICALLY CHECK THIS RECEIVER HITCH TO ENSURE THAT ALL FASTENERS ARE TIGHT AND THAT ALL STRUCTURAL COMPONENTS ARE SOUND.

Curt Manufacturing Inc., warrants this product to be free of defects in material and/or workmanship at the time of retail purchase by the original purchaser. If the product is found to be defective, Curt Manufacturing Inc., may repair or replace the product, at their option, when the product is returned, prepaid, with proof of purchase. Alteration to, misuse of, or improper installation of this product voids the warranty. Curt Manufacturing Inc.'s liability is limited to repair or replacement of products found to be defective, and specifically excludes liability for incidental or consequential loss or damage.

## APPROXIMATE AREA TO TRIM

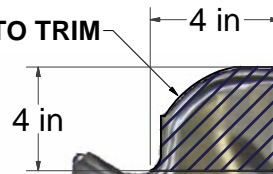
**RUBBER ISOLATOR  
REMOVAL DIAGRAM**

This technique can be used if and Exhaust Hanger Removal Pliers is not available.

Using a 5/8" open end wrench, slide the wrench up to the rubber isolator, cradling the hanger rod as shown. Next place the flat edge of a pry bar between the wrench and the hanger stop or hanger rod. Then simply rotate the pry bar toward the wrench to remove the rubber isolator.

**Note:** Using a spray lubricant or soapy water on the hanger rod and the rubber isolator helps removal.

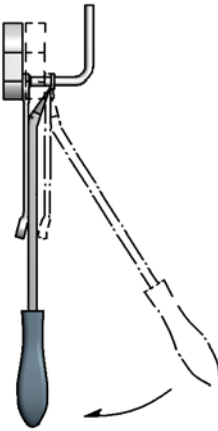
**HEAT SHIELD TRIM DIAGRAM  
(BOTH SIDES)****INSTALLATION STEPS**

1. Lower the exhaust by removing the (3) rear most rubber isolators on each side of the exhaust. Gently spread the exhaust to allow the mufflers to pass by the spare tire carrier. Support the exhaust system to prevent damage. (See Rubber Isolator Removal Diagram.)
2. Remove the existing M8 bolt from the bottom of the bumper support on each side of the vehicle. Return the bolts to the vehicle owner.
3. Remove the (3) bolts securing each heat shield and remove the heat shields from the vehicle. Trim the heat shields as shown and reinstall. (See Heat Shield Trim Diagram.)
4. Raise the hitch into position and loosely secure it to the frame rails using M10 hex bolts and conical toothed washers into the existing weld nuts as shown.
5. Secure the hitch to the lower bumper support using a M8 hex bolt, 5/16" lock washer and 5/16" flat washer into the existing weld nut on both sides as shown. Insert the 7/16" hex bolts with 3/8" flat washers into the existing hole as shown and secure with 7/16 hex flange nuts.
6. Raise the exhaust into position and reinstall the rubber isolators removed in Step 1.
7. Torque all M8 hardware to 17 ft-lbs., all M10 hardware to 37 ft-lbs., and all 7/16" hardware to 50 ft-lbs.

**PERIODICALLY CHECK THIS RECEIVER HITCH TO ENSURE THAT ALL FASTENERS  
ARE TIGHT AND THAT ALL STRUCTURAL COMPONENTS ARE SOUND.**

Curt Manufacturing Inc., warrants this product to be free of defects in material and/or workmanship at the time of retail purchase by the original purchaser. If the product is found to be defective, Curt Manufacturing Inc., may repair or replace the product, at their option, when the product is returned, prepaid, with proof of purchase. Alteration to, misuse of, or improper installation of this product voids the warranty. Curt Manufacturing Inc.'s liability is limited to repair or replacement of products found to be defective, and specifically excludes liability for incidental or consequential loss or damage.