



Safety glasses should be worn at all times while installing this product.

YEARS: 2014-PRESENT

MAKE: JEEP

MODEL: CHEROKEE

STYLE: SUV

WARNING: NEVER EXCEED YOUR VEHICLE MANUFACTURER'S RECOMMENDED TOWING CAPACITY

WEIGHT CARRYING:
 TRAILER WEIGHT: 5000 LBS.
 TONGUE WEIGHT: 750 LBS.

WEIGHT DISTRIBUTION:
 TRAILER WEIGHT: 6000 LBS.
 TONGUE WEIGHT: 750 LBS.

PRO INSTALL TIME: 25 MIN.
NOVICE INSTALL TIME: 50 MIN.

IF YOU ARE HESITANT TO UNDERTAKE THIS TASK ON YOUR OWN, CONTACT AN AUTHORIZED CURT INSTALLER FOR ADDITIONAL ASSISTANCE.

INSTALLATION REQUIRES:

 8mm 10mm 13mm 21mm SOCKET	 3/4" SOCKET	 TORQUE WRENCH
 CUT-OFF WHEEL	 TAPE MEASURE	 9" SOCKET EXTENSION
 RATCHET	 SAFETY GLASSES	

INSTALLATION TIPS:

- BEFORE YOU BEGIN INSTALLATION, READ ALL INSTRUCTIONS THOROUGHLY.
- TO EASE INSTALLATION, 2 PEOPLE MAY BE REQUIRED.
- USING PROPER TOOLS WILL GREATLY IMPROVE THE QUALITY OF THE INSTALL AND REDUCE THE TIME REQUIRED.

LEVEL OF DIFFICULTY: MODERATE

EASY	MODERATE	CHALLENGING
	-NO DRILLING REQUIRED	
	-FASCIA TRIMMING REQUIRED	
	-TEMPORARY PART REMOVAL	

VEHICLE PHOTO:



REPRESENTATIVE PHOTO

HITCH ILLUSTRATION:

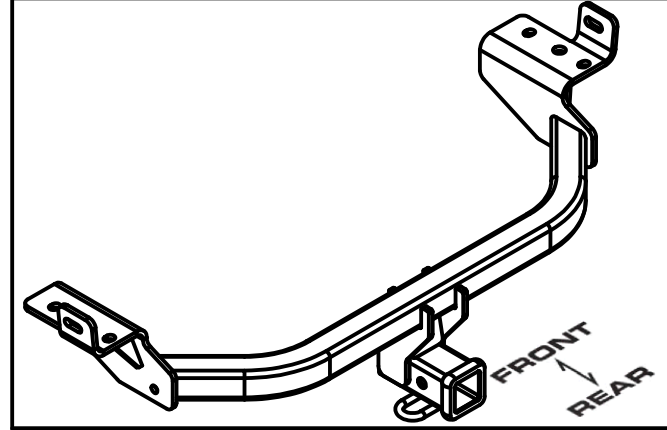

MAKE SURE YOUR HITCH MATCHES

INSTALLATION WALKTHROUGH:

Parts List			
ITEM	QTY	PART NUMBER	DESCRIPTION
1	6	HFN 1213, GR8	HEX FLANGE NUT
2	6	1/2-13 x 1 1/2, GR8	CARRIAGE BOLT
3	6	1_2 FISHWIRE	1/2" FISHWIRE
4	6	CM-SP6	.250 x 1.00 x 3.00" SQUARE SPACER

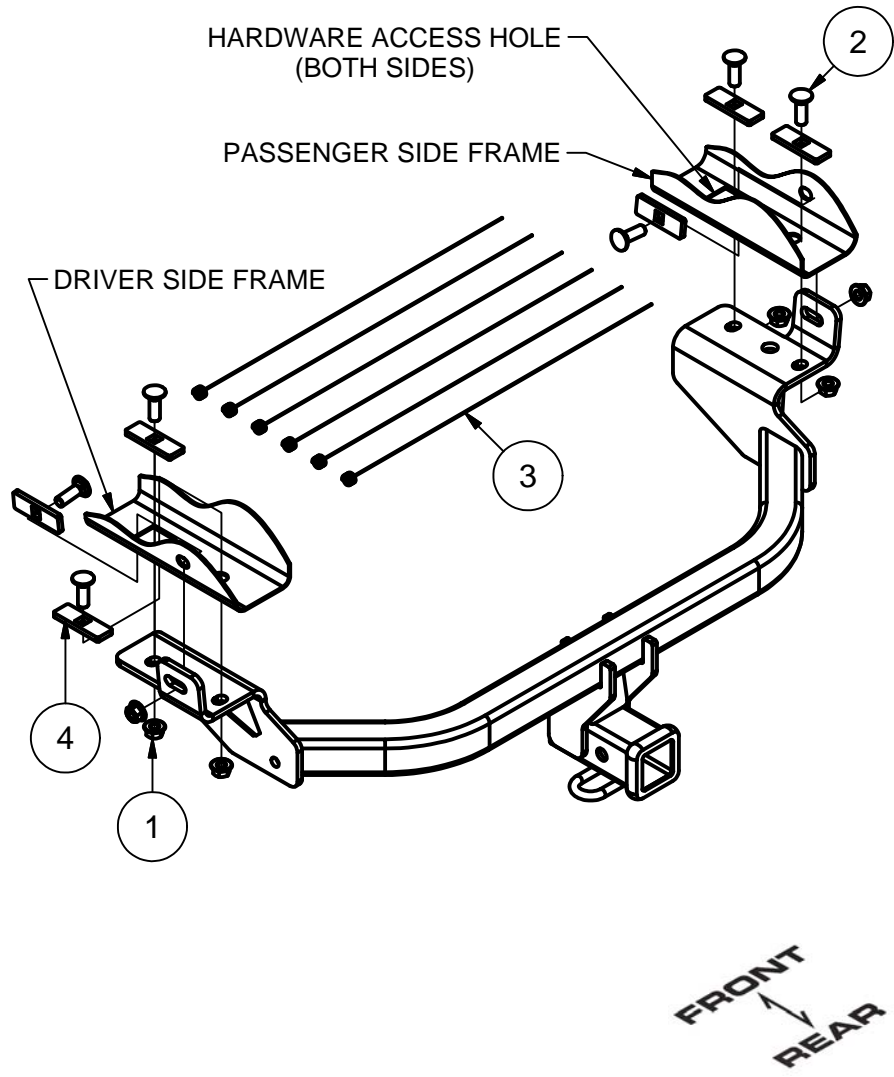

1. Lower exhaust by removing (2) bolts connecting the exhaust hanger bracket from the frame, using a 13mm socket (Both sides). Support exhaust from underneath during install.

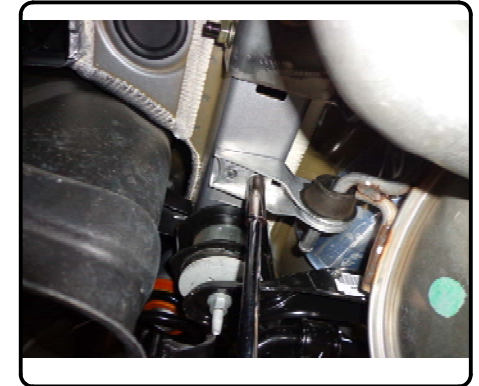
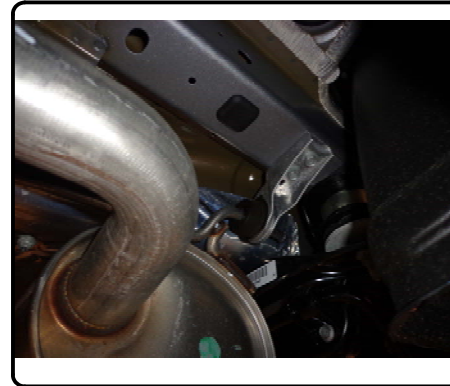

2. Temporarily remove fascia support by removing (4) screws using a 8mm socket, and pressing down on the tabs that hold the support in place.

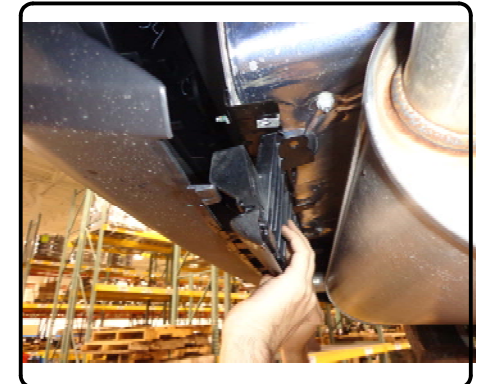

INSTALLATION WALKTHROUGH:

3. Trim the center of the fascia roughly 3 1/2" by 4 3/4" with a cut off wheel. (see pictures below, removing the fascia is not required for trimming)

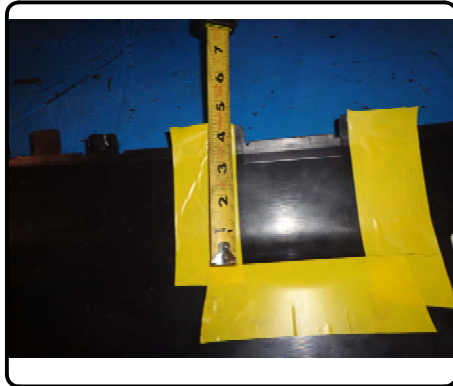

4. On Trailhawk models remove the rear vertical and the horizontal M14 existing bolts from the frame with a 21mm socket, save for reassembly. If wire on passenger side frame rail is present unfasten by pulling the retainer out of the frame, let wire hang below the frame rail.

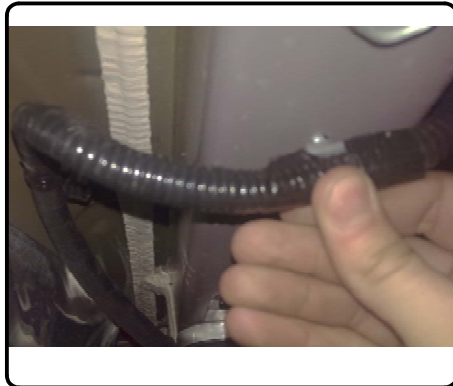
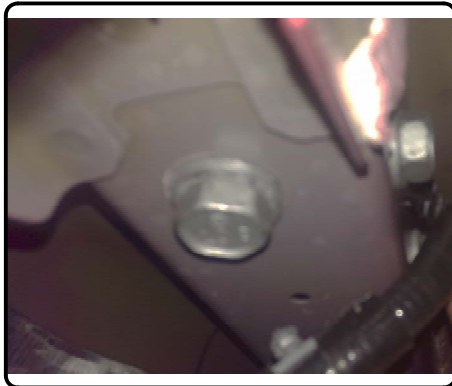

5. Remove square rubber plug from frame and discard to expose the access hole in the frame. (Each side)



6. Fishwire the rear and side hardware through access hole in frame, then reverse fishwire the hardware into the access hole (both sides). On Trailhawk models only the reverse fishwire hardware and M14 bolts removed in Step 4 are used.



INSTALLATION WALKTHROUGH:

7. Raise hitch into position and loosely secure hitch with the hardware, careful not to push hardware inside vehicle frame. (Check trim fitment around hitch, additional trimming may be required. Seam foam may need to be trimmed for proper fitment)



8. Torque 1/2" hardware to 110 lb-ft.
Torque M14 hardware to 139 lb-ft (If present).



9. Reinstall fascia support removed in Step (2). Raise exhaust back to original position, and secure exhaust bracket bolts. If present, reattach wire removed in Step (4) to its original position.



10. Install complete.



TOWING SAFETY INFORMATION

Gross Trailer Weight / GTW

The Gross Trailer Weight is the weight of the trailer & cargo. Measure this by putting the fully loaded trailer on a vehicle scale.

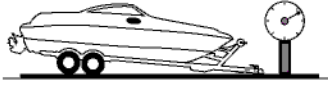

Tongue Weight / TW

The downward force that is exerted on the hitch ball by the coupler. The tongue weight will vary depending on where the load is positioned in relationship to the trailer axle(s). To measure the tongue weight, use either a commercial scale or a bathroom scale with the coupler at towing height. When using a bathroom scale with heavier tongue weights, use the method shown and multiply the scale reading by 3.

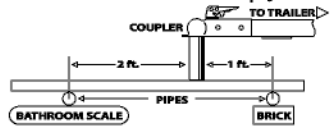

Weight Carrying / WC

The total weight of both the trailer and the cargo inside. Never exceed the weight capacity of your trailer hitch.

Weight Distribution / WD

Used to balance the weight of the cargo between the front and rear wheels throughout the trailer, allowing for better steering, braking, and level riding.



Sway Control

A device used to reduce the lateral movements of the trailer that are caused by the wind. This works in conjunction with a weight distribution hitch. Do not use this on a class 1 or 2 hitch, or with surge brakes.

How Much Can You Safely Tow?

TONGUE WEIGHT (lb)	1000	2000	3000	4000	5000	6000	7000	8000	10,000	12,000
Tongue weight should be about 10 to 15 percent of the gross trailer weight.										
CLASS 1										
CLASS 2										
CLASS 3										
CLASS 4										
CLASS 5										
TRAILER TYPE										
Camper	11'	12'	13'	14'	15'	16'				
lbs.	1100	1200	1300	1400	1500	1600				
Vacation	18'	19'	20'	21'	22'	24'	26'	28'	30'	32'
lbs.	2100	2400	2700	3000	3300	3600	3900	4200	4500	4800
Vacation	18'	19'	20'	21'	22'	24'	26'	28'	30'	32'
lbs.	2800	3200	3600	4000	4400	4800	5200	5600	6000	6400
5th Wheel										

Refer to owner's manual for towing capabilities and limitations.

Ball Mount

The ball mount is placed inside the opening of the receiver hitch which is mounted to the vehicle. Make sure a hitch pin and clip is properly securing the ball mount to the receiver hitch before you begin towing.

- A: Rise. B: Drop. C: Hole Size. D: Length.

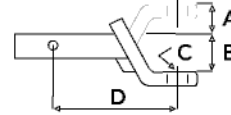

Trailer Ball

The connection from the hitch to the trailer. There are many factors that determine the correct hitch ball:

- Number one is the hitch ball's gross trailer weight rating.
- The mounting platform must be at least 3/8" thick.
- The hole diameter must not be more than 1/16" larger than the threaded shank.
- Every time you tow, check the nut and lock washer to make sure they are fastened securely.
- A: Ball Dia. B: Shank Length. C: Shank Dia. D: Shank Rise.

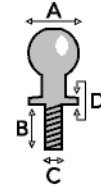

Coupler

The component that is placed over the trailer ball to connect the vehicle to the trailer. Be sure that the coupler size matches the size of the hitch ball and that the coupler handle is securely fastened. To determine what size hitch ball you need for your application you will need to know the size of coupler that is on the trailer. Be sure your coupler is properly adjusted to the ball you are using.

NOTE: For added security the use of safety devices such as Coupler Safety Pins and Locks is strongly recommended.

Safety Chains

Safety chains are a requirement and should be crossed under the tongue of the trailer so that the tongue will not drop to the road if it becomes separated from the hitch. Always leave enough slack so you can turn. Never allow the safety chains to drag on the ground and never attach the chains to the bumper.

Trailer Classification: Safety Chain Breaking Force - Minimum

Class 1: 2,000 lbs. (8.9 kN)

Class 2: 3,500 lbs. (15.6 kN)

Class 3: 5,000 lbs. (22.2 kN)

The strength rating of each length of safety chain or its equivalent and its attachments shall be equal to or exceed in minimum breaking force the GVWR (Gross Vehicle Weight Rating) of the trailer.

Electrical

Trailer lights, Electric Brakes, Break-away systems - Every time you tow, be sure to check that all components are working properly.

Wiring identification by color:

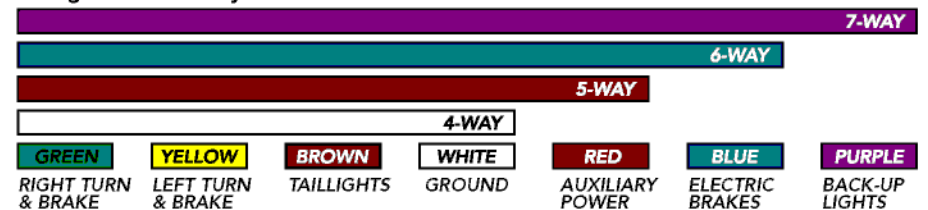

CURT DISCLAIMER: WIRING COLOR SHOWN WORK IN CONJUNCTION WITH CURT MANUFACTURING PRODUCTS.

13172

JEEP CHEROKEE

GROSS LOAD CAPACITY WHEN USED AS A WEIGHT CARRYING HITCH: 5000 LBS. TRAILER WEIGHT & 750 LBS. TONGUE WEIGHT.
 GROSS LOAD CAPACITY WHEN USED AS A WEIGHT DISTRIBUTION HITCH: 6000 LBS. TRAILER WEIGHT & 750 LBS. TONGUE WEIGHT
 DO NOT EXCEED VEHICLE MANUFACTURER'S RECOMMENDED TOWING CAPACITY.

Parts List			
ITEM	QTY	PART NUMBER	DESCRIPTION
1	6	HFN 1213, GR8	HEX FLANGE NUT
2	6	1/2-13 x 1 1/2, GR8	CARRIAGE BOLT
3	6	1_2 FISHWIRE	1/2" FISHWIRE
4	6	CM-SP6	.250 x 1.00 x 3.00" SQUARE SPACER

TOOLS REQUIRED	
	RATCHET
	TORQUE WRENCH
	8mm, 10mm, 13mm, 21mm, 3/4" SOCKETS
	CUT OFF WHEEL
	TAPE MEASURE
	9" SOCKET EXTENSION

FISHWIRE TECHNIQUE

INSERT COILED END OF FISHWIRE TOOL THROUGH HITCH MOUNTING HOLE IN VEHICLE FRAME RAIL AND OUT THE ACCESS HOLE. PASS COILED END OF FISHWIRE THROUGH SPACER AND THREAD BOLT INTO COIL. KINK WIRE TO KEEP SPACER SEPARATE FROM BOLT AS SHOWN. PULL FISHWIRE, SPACER, AND BOLT THROUGH FRAME AND OUT MOUNTING HOLE. USE FISHWIRE TO GUIDE HITCH DURING MOUNTING AND PREVENT LOSS OF BOLT / SPACER INSIDE FRAME RAIL.

NOTE: SOME VEHICLES MAY FISHWIRE THROUGH END OF FRAME

REVERSE PULL FISHWIRE TECHNIQUE

ATTACH FISHWIRE TO CARRIAGE BOLT AND SLIDE SPACER ONTO FISHWIRE. PUSH THE BOLT THRU THE HOLE FOLLOWED BY THE SPACER (AS SHOWN). PULL BOLT BACK INTO POSITION, PROTRUDING FROM THE FRAME.

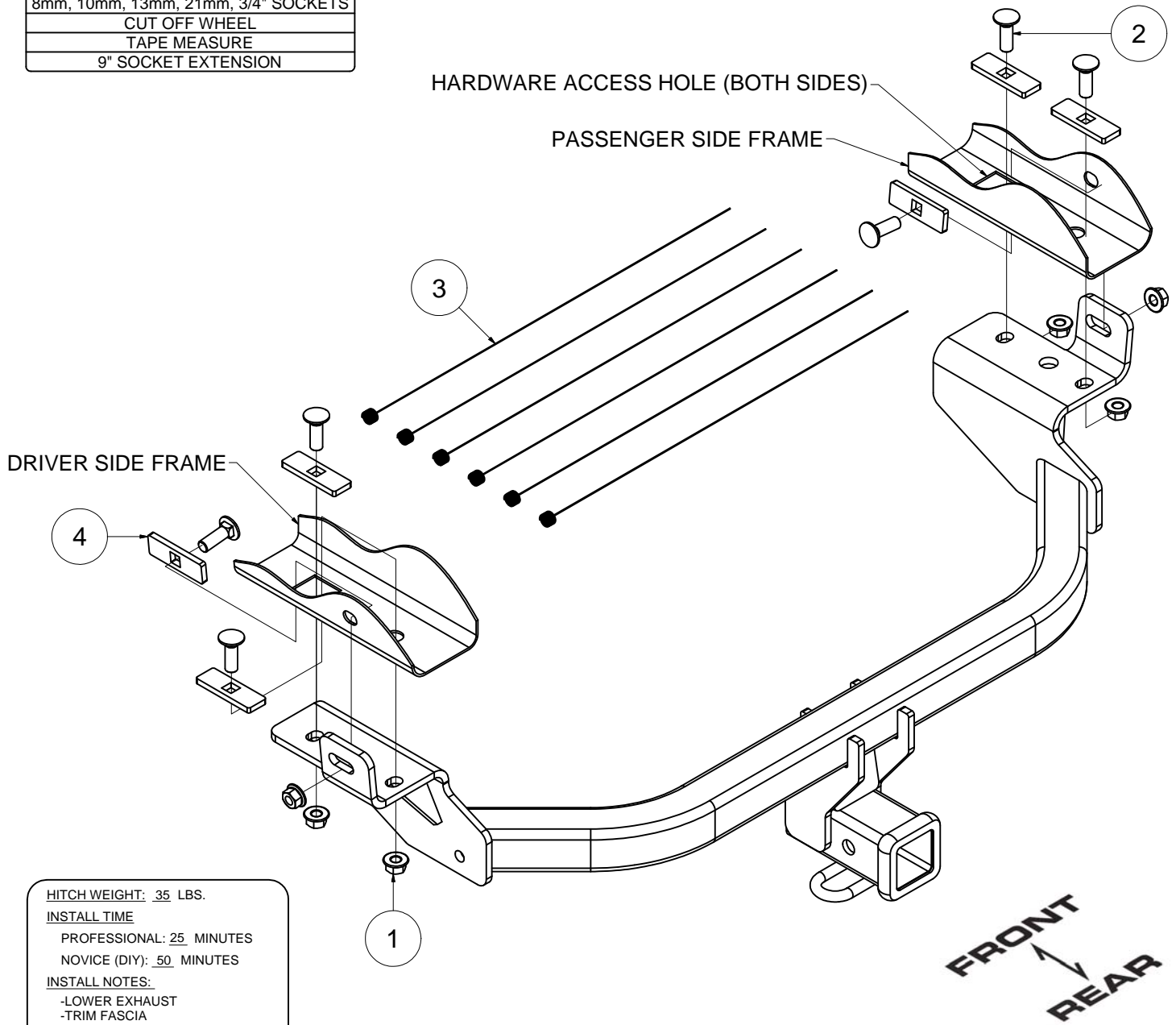

HITCH WEIGHT: 35 LBS.
INSTALL TIME
 PROFESSIONAL: 25 MINUTES
 NOVICE (DIY): 50 MINUTES
INSTALL NOTES:
 -LOWER EXHAUST
 -TRIM FASCIA
 -TEMPORARY PART REMOVAL
 -NO DRILLING REQUIRED

PERIODICALLY CHECK THIS RECEIVER HITCH TO ENSURE THAT ALL FASTENERS ARE TIGHT AND THAT ALL STRUCTURAL COMPONENTS ARE SOUND.

13172

JEEP CHEROKEE

GROSS LOAD CAPACITY WHEN USED AS A WEIGHT CARRYING HITCH: 5000 LBS. TRAILER WEIGHT & 750 LBS. TONGUE WEIGHT.
GROSS LOAD CAPACITY WHEN USED AS A WEIGHT DISTRIBUTION HITCH: 6000 LBS. TRAILER WEIGHT & 750 LBS. TONGUE WEIGHT

DO NOT EXCEED VEHICLE MANUFACTURER'S RECOMMENDED TOWING CAPACITY.

INSTALLATION STEPS

TRIM DIAGRAM

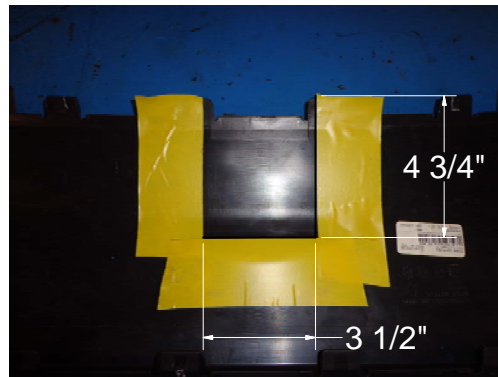

1. Lower exhaust by removing (2) bolts connecting the exhaust hanger bracket from the frame, using a 13mm socket (Both sides). Support exhaust from underneath during install.
2. Temporarily remove fascia support by removing (4) screws using a 8mm socket, and pressing down on the tabs that hold the support in place.
3. Trim the center of the fascia roughly 3 1/2" by 4 3/4" with a cut off wheel. (see trim diagram, removing the fascia is not required for trimming)
4. On Trailhawk models remove the rear vertical and the horizontal M14 existing bolts from the frame with a 21mm socket, save for reassembly. If wire on passenger side frame rail is present unfasten by pulling the retainer out of the frame, let wire hang below frame rail.
5. Remove square rubber plug from frame and discard to expose the access hole in the frame. (Each side)
6. Fishwire the rear and side hardware through access hole in frame, then reverse fishwire the hardware into the access hole (both sides). On Trailhawk models only the reverse fishwire hardware and M14 bolts removed in Step 4 are used.
7. Raise hitch into position and loosely secure hitch with the hardware, careful not to push hardware inside vehicle frame. (Check trim fitment around hitch, additional trimming may be required. Seam foam may need to be trimmed for proper fitment)
8. Torque 1/2" hardware to 110 lb-ft. Torque M14 hardware to 139 lb-ft (If present).
9. Reinstall fascia support removed in Step (2). Raise exhaust back to original position, and secure exhaust bracket bolts. If present, reattach wire removed in Step (4) to original position.

PERIODICALLY CHECK THIS RECEIVER HITCH TO ENSURE THAT ALL FASTENERS ARE TIGHT AND THAT ALL STRUCTURAL COMPONENTS ARE SOUND.