



Safety glasses should be worn at all times while installing this product.

YEARS: 2014-CURRENT

MAKE: SUBARU

MODEL: FORESTER

STYLE: SUV





WARNING: NEVER EXCEED YOUR VEHICLE MANUFACTURER'S RECOMMENDED TOWING CAPACITY

WEIGHT CARRYING:
 TRAILER WEIGHT: 3500 LBS.
 TONGUE WEIGHT: 525 LBS.

PRO INSTALL TIME: 30 MIN.
NOVICE INSTALL TIME: 60 MIN.

IF YOU ARE HESITANT TO UNDERTAKE THIS TASK ON YOUR OWN, CONTACT AN AUTHORIZED CURT INSTALLER FOR ADDITIONAL ASSISTANCE.





INSTALLATION REQUIRES:

| | | |
|---|--|--|
|  DIE GRINDER |  RATCHET |  10mm 3/4" SOCKET |
|  6" SOCKET EXTENSION |  SCREW DRIVER |  TORQUE WRENCH |
|  JACK STANDS |  SAFETY GLASSES | |
| | | |

INSTALLATION TIPS:

- BEFORE YOU BEGIN INSTALLATION, READ ALL INSTRUCTIONS THOROUGHLY.
- TO EASE INSTALLATION, 2 PEOPLE MAY BE REQUIRED.
- USING PROPER TOOLS WILL GREATLY IMPROVE THE QUALITY OF THE INSTALL AND REDUCE THE TIME REQUIRED.

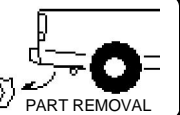
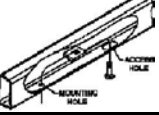
LEVEL OF DIFFICULTY: MODERATE

| EASY | MODERATE | CHALLENGING |
|---|-------------------------|-------------|
|  | RUBBER ISOLATER REMOVAL | |
|  | HOLE ENLARGEMENT | |
|  | PART REMOVAL | |
|  | FISHWIRE | |
|  | REVERSE FISHWIRE | |

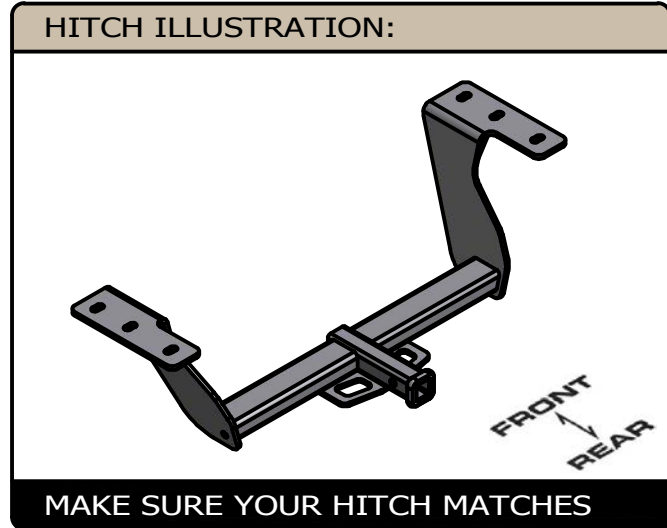

INSTALLATION WALKTHROUGH:

| Parts List | | | |
|------------|-----|---------------------|--|
| ITEM | QTY | PART NUMBER | DESCRIPTION |
| 1 | 6 | 1/2-13 x 1 3/4, GR8 | CARRIAGE BOLT |
| 2 | 6 | HFN 1213, GR8 | HEX FLANGE NUT |
| 3 | 6 | CM-SP10 | .250 x 1.00 x 2.50" SQUARE HOLE SPACER |
| 4 | 6 | 1_2 FISHWIRE | 1/2" FISHWIRE |

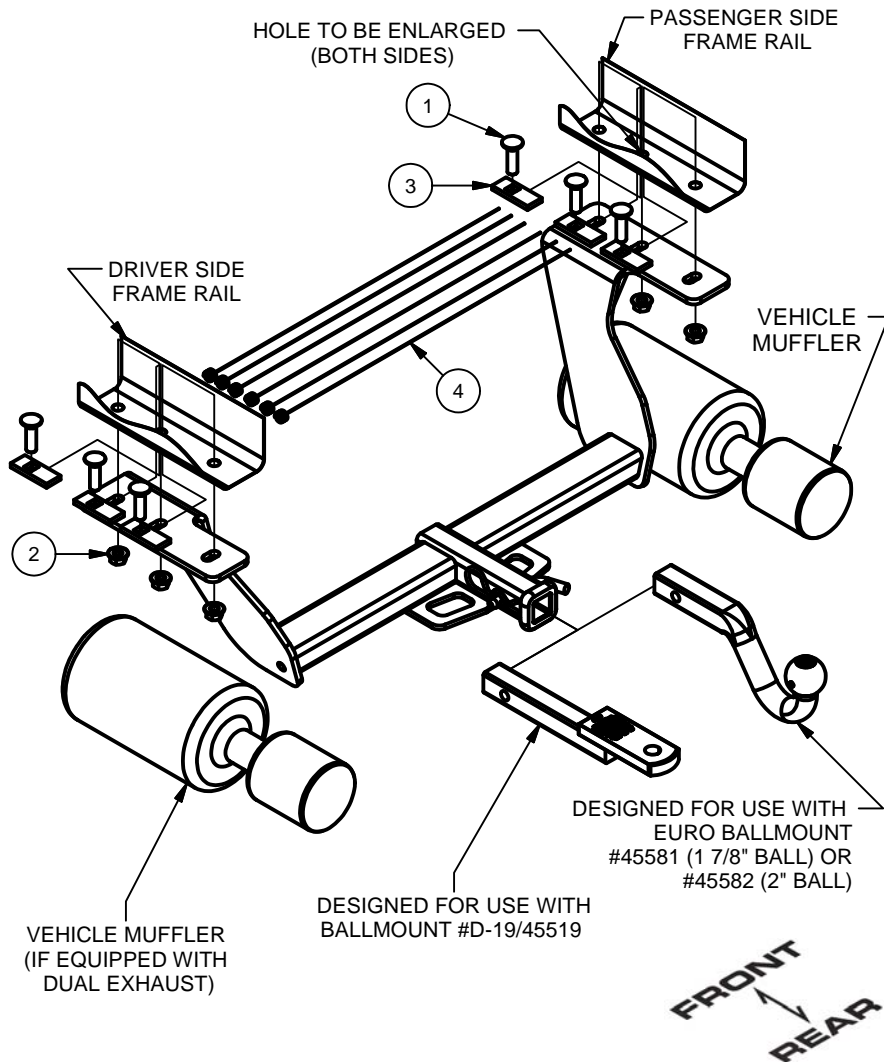

1. Remove (2) exhaust hangers from the passenger side muffler and (1) exhaust hanger from the center front of vehicle for single exhaust vehicles, dual exhaust will remove (2) exhaust hangers from the driver side muffler as well. Support lowered exhaust with jack stand.

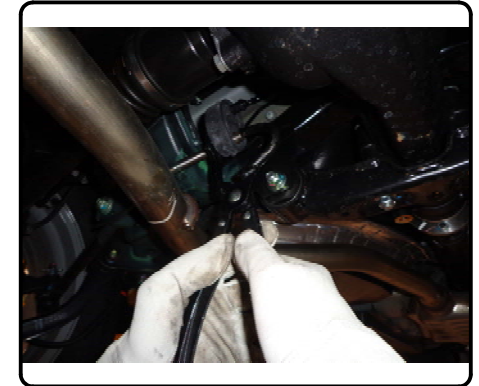

2. Remove (4) heat shield attachments with phillips head screwdriver or 10mm socket (both sides if equipped with dual exhaust). Remove three hole plugs from each side of frame to expose mounting holes. Return all removed items to customer.

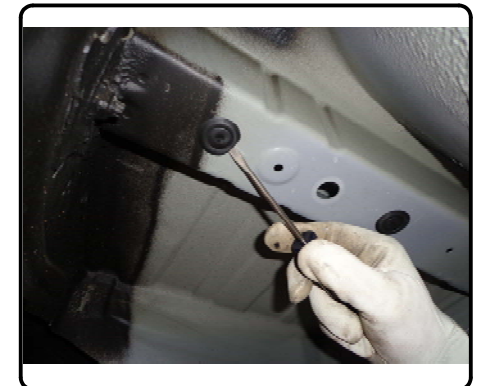

INSTALLATION WALKTHROUGH:

3. Enlarge the center hole on each side of the frame to about 1 1/8" to allow the mounting hardware to pass through. (Both sides)

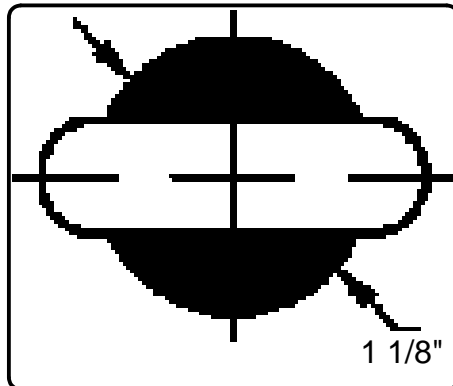

4. Fishwire 1/2" carriage bolt and spacer through the front and rear frame holes in both frame sides then reverse fishwire the center hole both sides.

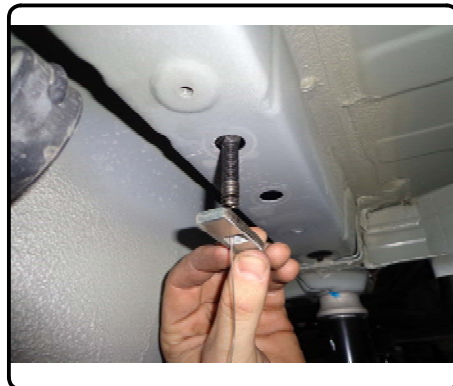
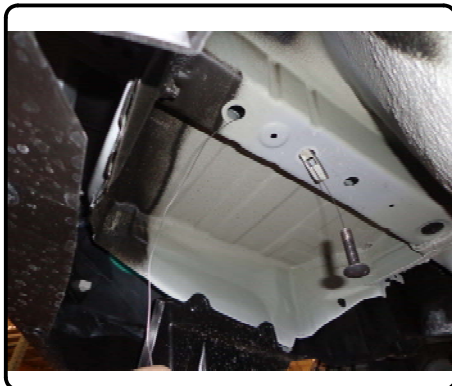

5. Raise hitch into place and secure hitch to frame, using the 1/2" hardware provided. Torque all hardware to 110ft-lb.

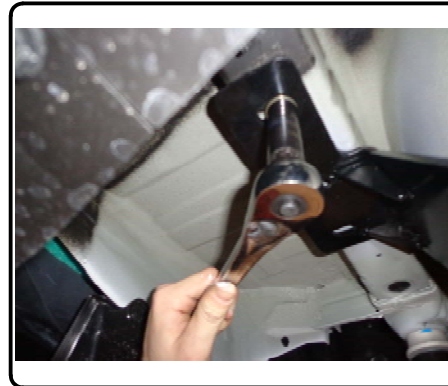

6. Raise exhaust back into place and reattach exhaust hangers. Install complete.

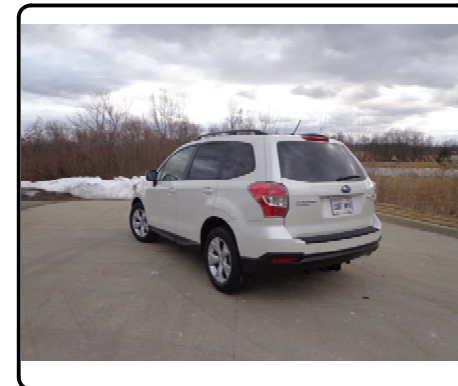

12100**SUBARU FORESTER****GROSS LOAD CAPACITY WHEN USED AS A WEIGHT CARRYING HITCH: 3500 LBS. TRAILER WEIGHT & 525 LBS. TONGUE WEIGHT.**

DO NOT EXCEED VEHICLE MANUFACTURER'S RECOMMENDED TOWING CAPACITY.

WARNING: ALL NON-TRAILER LOADS APPLIED TO THIS PRODUCT MUST BE SUPPORTED BY 18050 STABILIZING STRAPS.

** FAILURE TO PROPERLY SUPPORT NON-TRAILER LOADS WILL VOID PRODUCT WARRANTY**

| Parts List | | | |
|------------|-----|---------------------|--|
| ITEM | QTY | PART NUMBER | DESCRIPTION |
| 1 | 6 | 1/2-13 x 1 3/4, GR8 | CARRIAGE BOLT |
| 2 | 6 | HFN 1213, GR8 | HEX FLANGE NUT |
| 3 | 6 | CM-SP10 | .250 x 1.00 x 2.50" SQUARE HOLE SPACER |
| 4 | 6 | 1_2 FISHWIRE | 1/2" FISHWIRE |

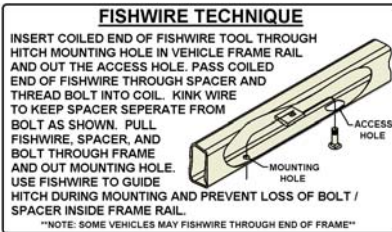
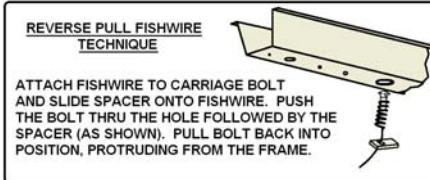

| TOOLS REQUIRED | |
|---------------------|--|
| RATCHET | |
| 10mm, 3/4" SOCKET | |
| 6" SOCKET EXTENSION | |
| SCREW DRIVER | |
| GRINDER/ DRILL | |
| TORQUE WRENCH | |
| JACK STAND | |

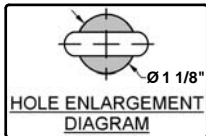

VEHICLE MUFFLER (IF EQUIPPED WITH DUAL EXHAUST)

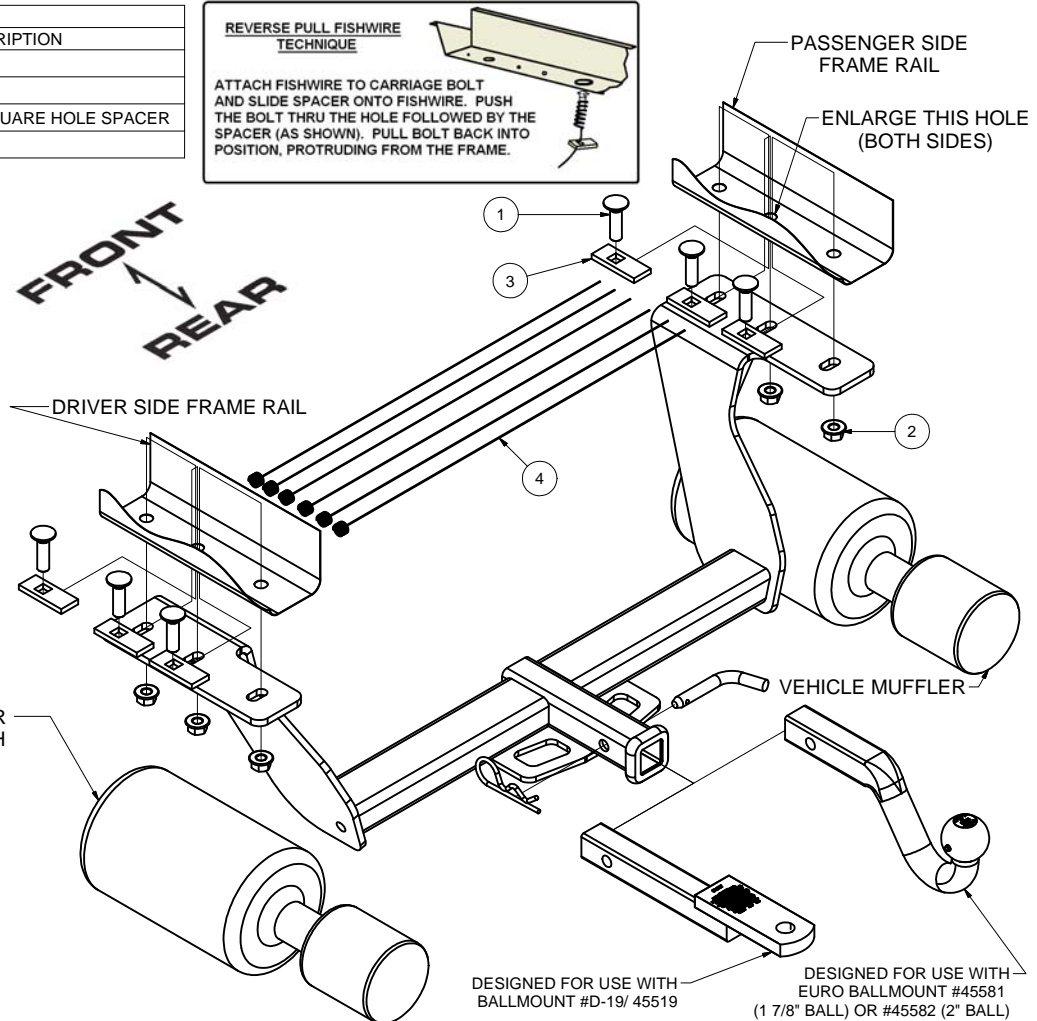

HITCH WEIGHT: 35 LBS.

INSTALL TIME

PROFESSIONAL: 30 MINUTES

NOVICE (DIY): 60 MINUTES

INSTALL NOTES:

- PART REMOVAL
- HOLE ENLARGEMENT
- FISHWIRE
- REVERSE FISHWIRE

INSTALLATION STEPS

1. Remove (2) exhaust hangers from the passenger side muffler and (1) exhaust hanger from the center front of vehicle for single exhaust vehicles, dual exhaust will remove (2) exhaust hangers from the driver side muffler as well. Support lowered exhaust with jack stand.
2. Remove (4) heat shield attachments with phillips head screwdriver or 10mm socket (both sides if equipped with dual exhaust). Remove three hole plugs from each side of frame to expose mounting holes. Return all removed items to customer.
3. Enlarge the center hole on each side of the frame to about 1 1/8" to allow the mounting hardware to pass though. (Both sides)
4. Fishwire 1/2" carriage bolt and spacer through the front and rear frame holes in both frame sides, then reverse fishwire the center hole both sides.
5. Raise hitch into place and secure hitch to frame using the 1/2" hardware provided. Torque all hardware to 110ft-lb.
6. Raise exhaust back into place and reattach exhaust hangers.

PERIODICALLY CHECK THIS RECEIVER HITCH TO ENSURE THAT ALL FASTENERS ARE TIGHT AND THAT ALL STRUCTURAL COMPONENTS ARE SOUND.