



Safety glasses should be worn at all times while installing this product.

YEARS: 2013-PRESENT

MAKE: HYUNDAI

MODEL: ELANTRA GT

STYLE: 5 DOOR





**WARNING: NEVER EXCEED YOUR VEHICLE MANUFACTURER'S RECOMMENDED TOWING CAPACITY**

**WEIGHT CARRYING:**  
 TRAILER WEIGHT: 2,000 LBS.  
 TONGUE WEIGHT: 200 LBS.

**PRO INSTALL TIME: 25 MIN.**  
**NOVICE INSTALL TIME: 55 MIN.**

IF YOU ARE HESITANT TO UNDERTAKE THIS TASK ON YOUR OWN, CONTACT AN AUTHORIZED CURT INSTALLER FOR ADDITIONAL ASSISTANCE.



**INSTALLATION REQUIRES:**

 RATCHET	 6" SOCKET EXTENSION	 14mm 13mm 12mm 3/4" SOCKET
 TORQUE WRENCH	 POWER DRILL	 DRILL BIT 7/16 in
 SAFETY GLASSES		

**INSTALLATION TIPS:**

- BEFORE YOU BEGIN INSTALLATION, READ ALL INSTRUCTIONS THOROUGHLY.
- TO EASE INSTALLATION, 2 PEOPLE MAY BE REQUIRED.
- USING PROPER TOOLS WILL GREATLY IMPROVE THE QUALITY OF THE INSTALL AND REDUCE THE TIME REQUIRED.

**LEVEL OF DIFFICULTY: MODERATE**

EASY	MODERATE	CHALLENGING
	-HOLE ENLARGEMENT	
	- LOWER EXHAUST	

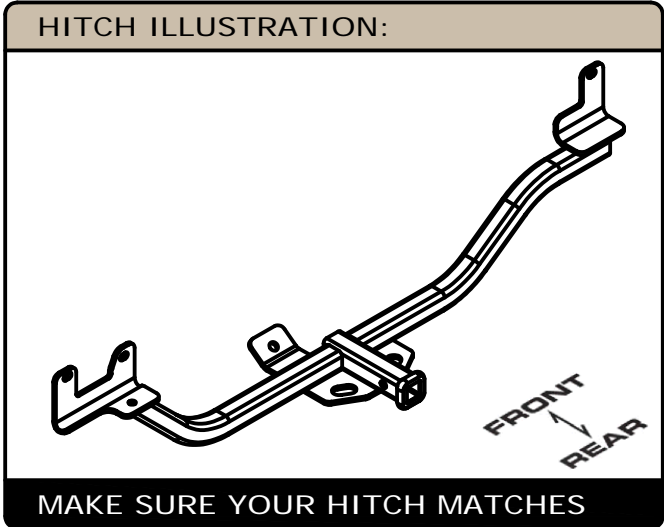

# INSTALLATION WALKTHROUGH:

Parts List			
ITEM	QTY	PART NUMBER	DESCRIPTION
1	1	1/2-13 x 1 3/4	CARRIAGE BOLT
2	1	CM-SP6	.250 x 1.00 x 3.00" SQUARE HOLE SPACER
3	1	HFN 1213, GR8	HEX FLANGE NUT
4	3	M8-1.25 x 35	HEX BOLT
5	3	3/8"	CONICAL TOOTHED WASHER

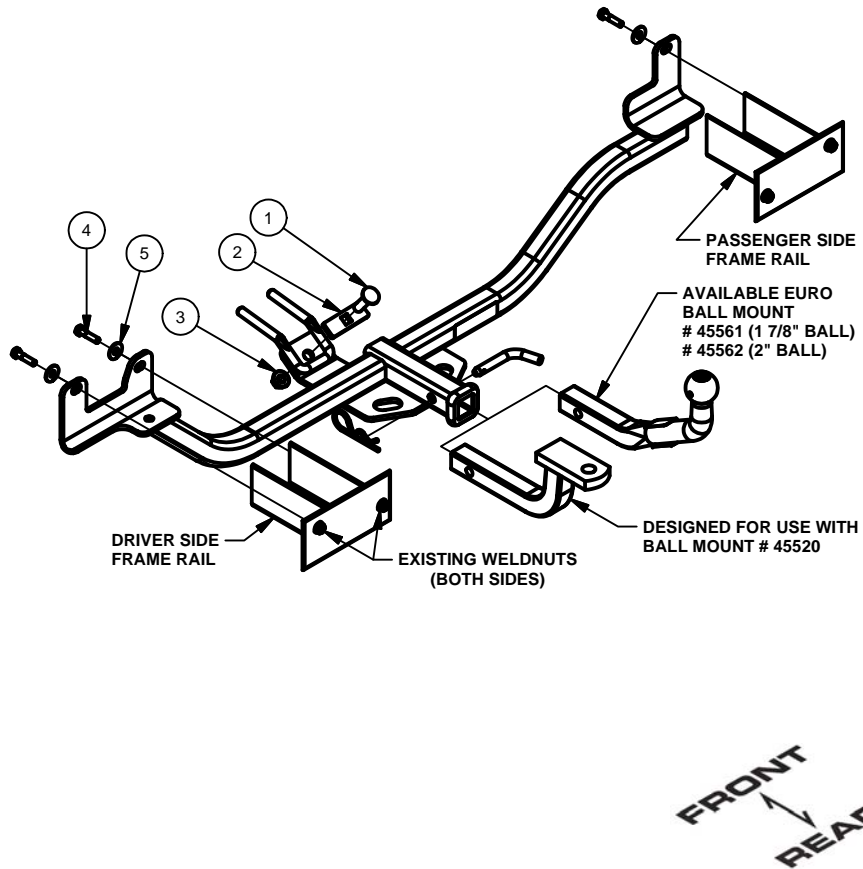

1. Lower exhaust by disconnecting two rubber isolators, see diagram.



**RUBBER ISOLATOR REMOVAL DIAGRAM**

This technique can be used if an Exhaust Hanger Removal Pliers is not available.

Using a 5/8" open end wrench, slide the wrench up to the rubber isolator, cradling the hanger rod as shown. Next place the flat edge of a pry bar between the wrench and the hanger stop or hanger rod. Then simply rotate the pry bar toward the wrench to remove the rubber isolator.

Note: Using a spray lubricant or soapy water on the hanger rod and the rubber isolator helps removal.

2. Remove (1) nut using a 12mm socket from the bracket holding the module on the rear driver side frame rail.

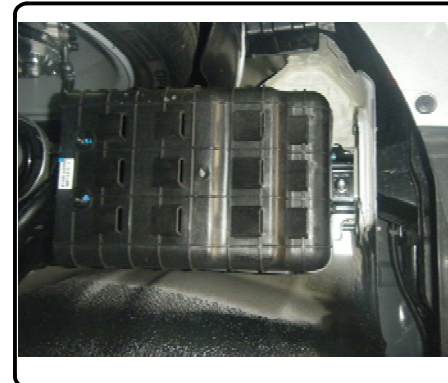

## INSTALLATION WALKTHROUGH:

3. Lower module and enlarge the hole to 7/16".

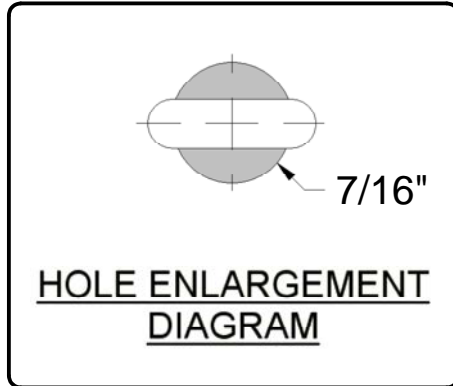

4. Remove (3) bolts using a 14mm socket from bumper support. Leave the inner passenger side bolt.

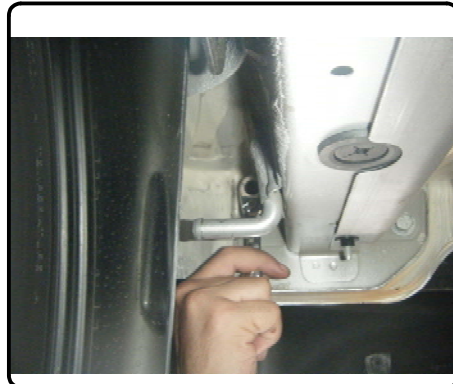

5. Position hitch in place and use the (3) 8mm supplied bolts and conical washers, lightly tighten.



6. Install 1/2" carriage bolt with spacer through tow hook and hitch, lightly tighten with 1/2" flange nut provided.



## INSTALLATION WALKTHROUGH:

7. Torque all 8mm bolts to 25lb-ft, and torque the 1/2" nut to 110lb-ft.

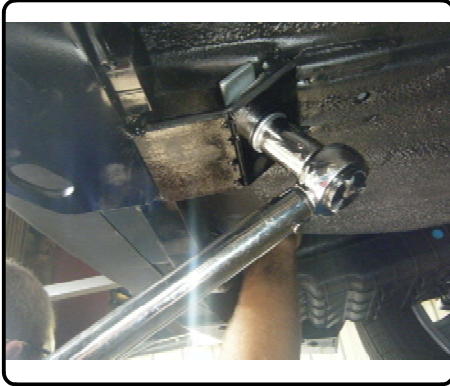

8. Reinstall exhaust isolators.



9. Reinstall the module with the original nut.



10. Installation complete.

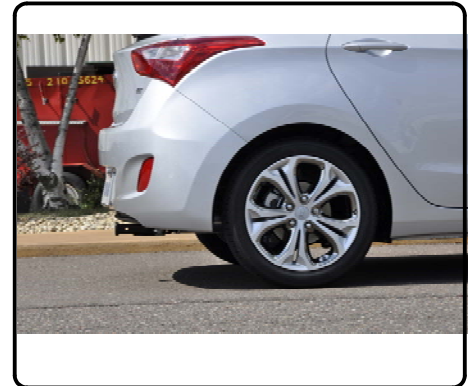

## TOWING SAFETY INFORMATION

### Gross Trailer Weight / GTW

The Gross Trailer Weight is the weight of the trailer & cargo. Measure this by putting the fully loaded trailer on a vehicle scale.

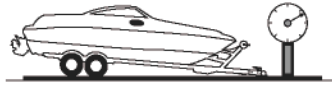

### Tongue Weight / TW

The downward force that is exerted on the hitch ball by the coupler. The tongue weight will vary depending on where the load is positioned in relationship to the trailer axle(s). To measure the tongue weight, use either a commercial scale or a bathroom scale with the coupler at towing height. When using a bathroom scale with heavier tongue weights, use the method shown and multiply the scale reading by 3.

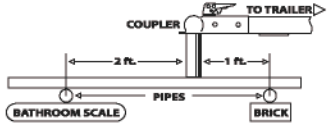

### Weight Carrying / WC

The total weight of both the trailer and the cargo inside. Never exceed the weight capacity of your trailer hitch.

### Weight Distribution / WD

Used to balance the weight of the cargo between the front and rear wheels throughout the trailer, allowing for better steering, braking, and level riding.



### Sway Control

A device used to reduce the lateral movements of the trailer that are caused by the wind. This works in conjunction with a weight distribution hitch. Do not use this on a class 1 or 2 hitch, or with surge brakes.

### How Much Can You Safely Tow?

TONGUE WEIGHT lbs	1000	2000	3000	4000	5000	6000	7000	8000	10,000	12,000
Tongue weight should be about 10 to 15 percent of the gross trailer weight.										
CLASS 1										
CLASS 2										
CLASS 3										
CLASS 4										
CLASS 5										
<b>Camper</b>	11'	12'	13'	14'	15'	16'				
lbs	1100	1200	1300	1400	1500	1600				
<b>Vacation</b>	14'	16'	18'	20'	22'	24'	26'	28'	30'	32'
lbs	2100	2400	2700	3000	3300	3600	3900	4200	4500	4800
<b>Vacation</b>	14'	16'	18'	20'	22'	24'	26'	28'	30'	32'
lbs	2800	3200	3600	4000	4400	4800	5200	5600	6000	6400
<b>5th Wheel</b>										

Refer to owner's manual for towing capabilities and limitations.

### Ball Mount

The ball mount is placed inside the opening of the receiver hitch which is mounted to the vehicle. Make sure a hitch pin and clip is properly securing the ball mount to the receiver hitch before you begin towing.

- A: Rise. B: Drop. C: Hole Size. D: Length.

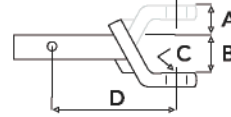

### Trailer Ball

The connection from the hitch to the trailer. There are many factors that determine the correct hitch ball:

- Number one is the hitch ball's gross trailer weight rating.
- The mounting platform must be at least 3/8" thick.
- The hole diameter must not be more than 1/16" larger than the threaded shank.
- Every time you tow, check the nut and lock washer to make sure they are fastened securely.
- A: Ball Dia. B: Shank Dia. C: Shank Length. D: Shank Rise.

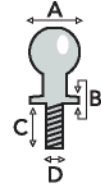

### Coupler

The component that is placed over the trailer ball to connect the vehicle to the trailer. Be sure that the coupler size matches the size of the hitch ball and that the coupler handle is securely fastened. To determine what size hitch ball you need for your application you will need to know the size of coupler that is on the trailer. Be sure your coupler is properly adjusted to the ball you are using.

NOTE: For added security the use of safety devices such as Coupler Safety Pins and Locks is strongly recommended.

### Safety Chains

Safety chains are a requirement and should be crossed under the tongue of the trailer so that the tongue will not drop to the road if it becomes separated from the hitch. Always leave enough slack so you can turn. Never allow the safety chains to drag on the ground and never attach the chains to the bumper.

Trailer Classification: Safety Chain Breaking Force - Minimum

Class 1: 2,000 lbs. (8.9 kN)

Class 2: 3,500 lbs. (15.6 kN)

Class 3: 5,000 lbs. (22.2 kN)

The strength rating of each length of safety chain or its equivalent and its attachments shall be equal to or exceed in minimum breaking force the GVWR (Gross Vehicle Weight Rating) of the trailer.

### Electrical

Trailer lights, Electric Brakes, Break-away systems - Every time you tow, be sure to check that all components are working properly.

Wiring identification by color:

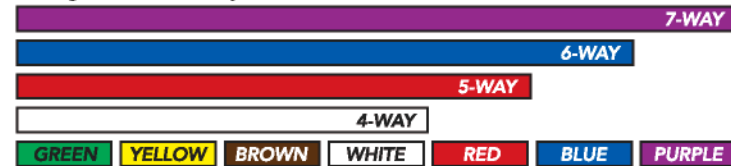

**11400****HYUNDAI ELANTRA GT****GROSS LOAD CAPACITY WHEN USED AS A WEIGHT CARRYING HITCH: 2,000 LBS. TRAILER WEIGHT & 200 LBS. TONGUE WEIGHT.**

\*\*\*DO NOT EXCEED VEHICLE MANUFACTURER'S RECOMMENDED TOWING CAPACITY.\*\*\*

**WARNING: ALL NON-TRAILER LOADS APPLIED TO THIS PRODUCT MUST BE SUPPORTED BY 18050 STABILIZING STRAPS.**

\*\* FAILURE TO PROPERLY SUPPORT NON-TRAILER LOADS WILL VOID PRODUCT WARRANTY\*\*

Parts List				
ITEM	QTY	PART NUMBER	DESCRIPTION	
1	1	1/2-13 x 1 3/4	CARRIAGE BOLT	
2	1	CM-SP6	.250 x 1.00 x 3.00" SQUARE HOLE SPACER	
3	1	HFN 1213, GR8	HEX FLANGE NUT	
4	3	M8-1.25 x 35	HEX BOLT	
5	3	3/8"	CONICAL TOOTHED WASHER	

TOOLS REQUIRED
RATCHET
6" SOCKET EXTENSION
12mm, 13mm, 14mm, 3/4 in SOCKET
TORQUE WRENCH
DRILL
7/16 in DRILL BIT

**RUBBER ISOLATOR REMOVAL DIAGRAM**

This technique can be used if an Exhaust Hanger Removal Pliers is not available.

Using a 5/8" open end wrench, slide the wrench up to the rubber isolator, cradling the hanger rod as shown. Next place the flat edge of a pry bar between the wrench and the hanger stop or hanger rod. Then simply rotate the pry bar toward the wrench to remove the rubber isolator.

Note: Using a spray lubricant or soapy water on the hanger rod and the rubber isolator helps removal.

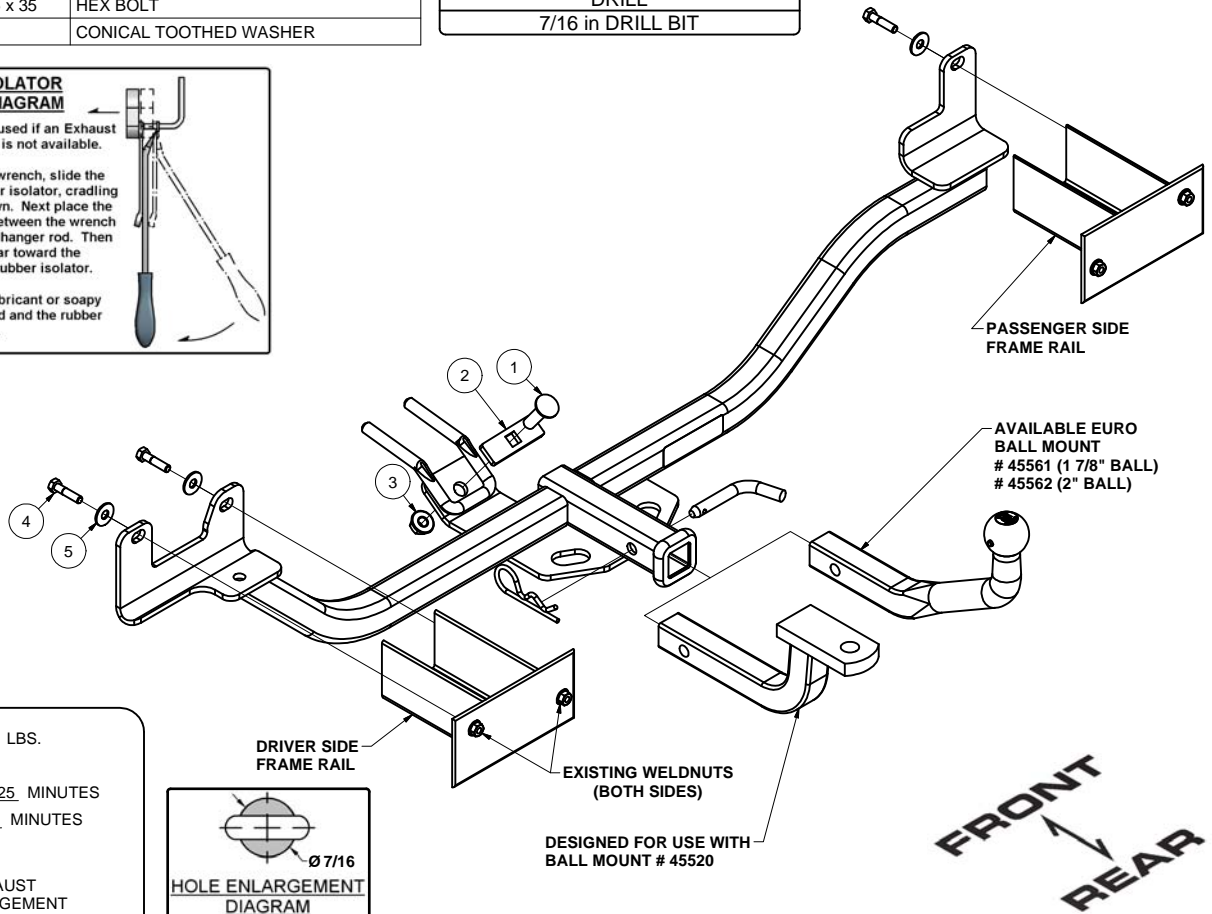
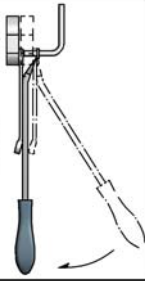
**HITCH WEIGHT:** 23 LBS.**INSTALL TIME**

PROFESSIONAL: 25 MINUTES

NOVICE (DIY): 55 MINUTES

**INSTALL NOTES:**

- LOWER EXHAUST
- HOLE ENLARGEMENT

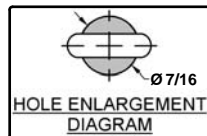
**INSTALLATION STEPS**

1. Lower exhaust by disconnecting two rubber isolators see diagram.
2. Remove (1) nut using a 12mm socket from the bracket holding the module on the rear driver side frame rail.
3. Lower module and enlarge the hole to 7/16".
4. Remove (3) bolts using a 14mm socket from bumper support. Leave the inner passenger side bolt.
5. Position hitch in place and use the (3) 8mm supplied bolts and conical washers, lightly tighten.
6. Install 1/2" carriage bolt with spacer through tow hook and hitch, lightly tighten with 1/2" flange nut provided.
7. Torque all 8mm bolts to 25lb-ft, and torque the 1/2" nut to 110lb-ft.
8. Reinstall exhaust isolators, and reinstall the module with the original nut.

PERIODICALLY CHECK THIS RECEIVER HITCH TO ENSURE THAT ALL FASTENERS ARE TIGHT AND THAT ALL STRUCTURAL COMPONENTS ARE SOUND.