



Safety glasses should be worn at all times while installing this product.

YEARS: 2011-PRESENT

MAKE: NISSAN

MODEL: LEAF

STYLE: HATCHBACK

WARNING: NEVER EXCEED YOUR VEHICLE MANUFACTURER'S RECOMMENDED TOWING CAPACITY

WEIGHT CARRYING:
 TRAILER WEIGHT: 1,500 LBS.
 TONGUE WEIGHT: 150 LBS.

PRO INSTALL TIME: 35 MIN.
NOVICE INSTALL TIME: 70 MIN.

IF YOU ARE HESITANT TO UNDERTAKE THIS TASK ON YOUR OWN, CONTACT AN AUTHORIZED CURT INSTALLER FOR ADDITIONAL ASSISTANCE.

INSTALLATION REQUIRES:

RATCHET	TORQUE WRENCH	6" SOCKET EXTENSION
SOCKET	SOCKET	SCREW DRIVER
DIE GRINDER	POWER DRILL	DRILL BIT 1/2"
ROTARY TOOL	SAFETY GLASSES	

INSTALLATION TIPS:

- BEFORE YOU BEGIN INSTALLATION, READ ALL INSTRUCTIONS THOROUGHLY.
- TO EASE INSTALLATION, 2 PEOPLE MAY BE REQUIRED.
- USING PROPER TOOLS WILL GREATLY IMPROVE THE QUALITY OF THE INSTALL AND REDUCE THE TIME REQUIRED.

LEVEL OF DIFFICULTY: MODERATE

EASY	MODERATE	CHALLENGING
	- PART REMOVAL	
	- HOLE ENLARGEMENT DRILL HOLE	
	- FISHWIRE HARDWARE	
	- TRIM UNDERBODY PANEL	

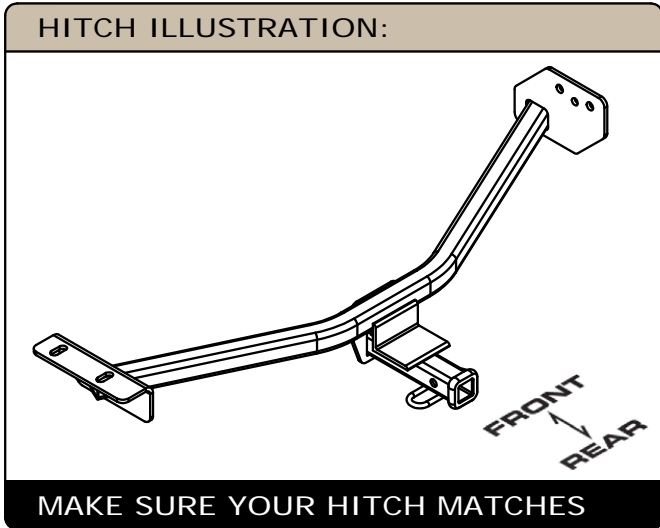

INSTALLATION WALKTHROUGH:

Parts List			
ITEM	QTY	PART NUMBER	DESCRIPTION
1	2	7/16-14	HEX FLANGE NUT
2	2	7/16-14 x 1 1/2	CARRIAGE BOLT
3	2	7_16 FISHWIRE	7/16" FISHWIRE
4	2	CM-SP2	.250 x .88 x 2.25" SQUARE HOLE SPACER
5	3	M10 - 1.25 HEX FLANGE NUT	HEX FLANGE NUT

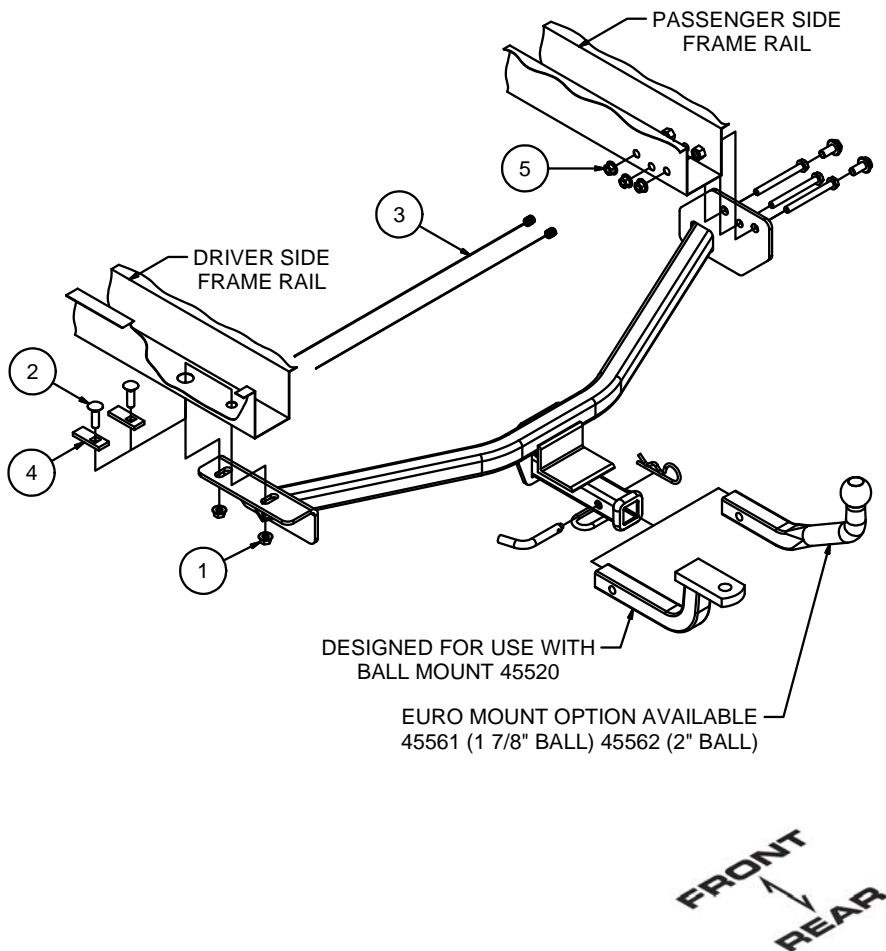

1. Remove the fasteners securing the underbody panel. Retain underbody panel and fasteners for reinstallation.



2. Depending on the model, remove either (4) M12 bolts or (3) M10 bolts securing the tow loop to the passenger side frame rail. Retain (2) M12 bolts or (3) M10 bolts for reinstallation. Return the tow loop and (2 of the 4) M12 bolts to the owner.

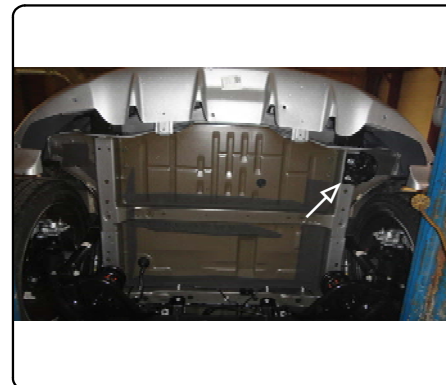

INSTALLATION WALKTHROUGH:

3. If the rear-most driver side hole is not present, raise the hitch into position and mark the hole to be drilled. Lower the hitch and drill marked hole. **Note:** Before drilling hole make sure all existing holes are aligned. Enlarge the driver side access hole to allow 7/16" hardware to pass through.



4. Fishwire the 7/16" carriage bolt and SP2 spacer through the enlarged access hole and out the rear-most hole.

FISHWIRE TECHNIQUE
INSERT COILED END OF FISHWIRE TOOL THROUGH HITCH MOUNTING HOLE IN VEHICLE FRAME RAIL AND OUT THE ACCESS HOLE. PASS COILED END OF FISHWIRE THROUGH SPACER AND THREAD BOLT INTO COIL. KINK WIRE TO KEEP SPACER SEPERATE FROM BOLT AS SHOWN. PULL FISHWIRE, SPACER, AND BOLT THROUGH FRAME AND OUT MOUNTING HOLE. USE FISHWIRE TO GUIDE HITCH DURING MOUNTING AND PREVENT LOSS OF BOLT / SPACER INSIDE FRAME RAIL.
NOTE: SOME VEHICLES MAY FISHWIRE THROUGH END OF FRAME

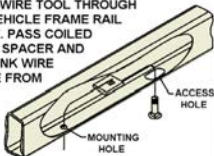

5. Reverse fishwire the 7/16" carriage bolt and SP2 spacer into the enlarged access hole.

REVERSE PULL FISHWIRE TECHNIQUE

ATTACH FISHWIRE TO CARRIAGE BOLT AND SLIDE SPACER ONTO FISHWIRE. PUSH THE BOLT THRU THE HOLE FOLLOWED BY THE SPACER (AS SHOWN). PULL BOLT BACK INTO POSITION, PROTRUDING FROM THE FRAME.

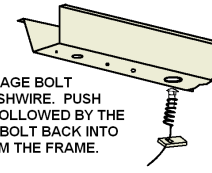

6. Raise the hitch into position and secure the driver side using the provided 7/16" flange nuts. Secure the passenger side with either the existing (2) M12 bolts into the existing weldnuts in the side of the frame or the existing (3) M10 bolts through the frame rail and secure using the provided M10 flange nuts.



INSTALLATION WALKTHROUGH:

7. Torque all 7/16" hardware to 70 ft-lbs.
Torque all M10 hardware to 48 ft-lbs.
Torque all M12 hardware to 90 ft-lbs.

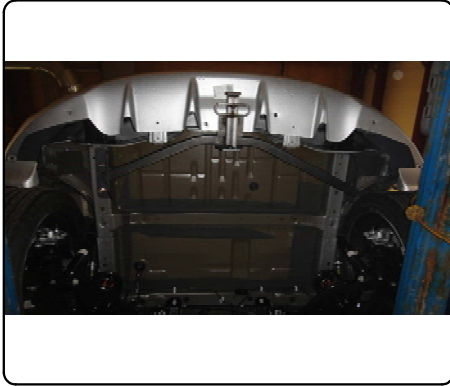

8. Trim underbody panel as shown in green area.

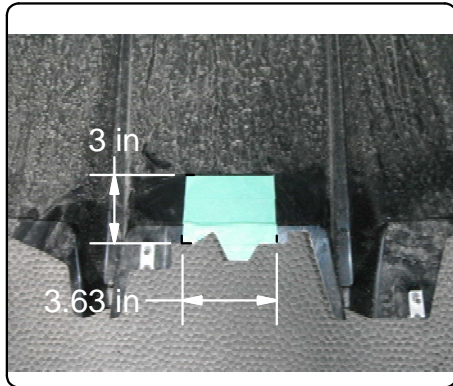

9. Reinstall underbody panel using hardware removed in Step (1).

INSTALLATION COMPLETE



TOWING SAFETY INFORMATION

Gross Trailer Weight / GTW

The Gross Trailer Weight is the weight of the trailer & cargo. Measure this by putting the fully loaded trailer on a vehicle scale.

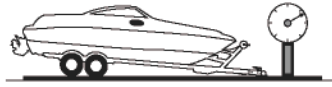

Tongue Weight / TW

The downward force that is exerted on the hitch ball by the coupler. The tongue weight will vary depending on where the load is positioned in relationship to the trailer axle(s). To measure the tongue weight, use either a commercial scale or a bathroom scale with the coupler at towing height. When using a bathroom scale with heavier tongue weights, use the method shown and multiply the scale reading by 3.

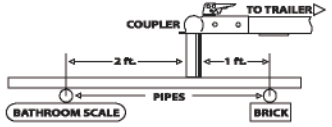

Weight Carrying / WC

The total weight of both the trailer and the cargo inside. Never exceed the weight capacity of your trailer hitch.

Weight Distribution / WD

Used to balance the weight of the cargo between the front and rear wheels throughout the trailer, allowing for better steering, braking, and level riding.



Sway Control

A device used to reduce the lateral movements of the trailer that are caused by the wind. This works in conjunction with a weight distribution hitch. Do not use this on a class 1 or 2 hitch, or with surge brakes.

How Much Can You Safely Tow?

TONGUE WEIGHT lbs	1000	2000	3000	4000	5000	6000	7000	8000	10,000	12,000
Tongue weight should be about 10 to 15 percent of the gross trailer weight.										
CLASS 1										
CLASS 2										
CLASS 3										
CLASS 4										
CLASS 5										
Camper	11'	12'	13'	14'	15'	16'				
lbs	1100	1200	1300	1400	1500	1600				
Vacation	14'	16'	18'	20'	22'	24'	26'	28'	30'	32'
lbs	2100	2400	2700	3000	3300	3600	3900	4200	4500	4800
Vacation	14'	16'	18'	20'	22'	24'	26'	28'	30'	32'
lbs	2800	3200	3600	4000	4400	4800	5200	5600	6000	6400
5th Wheel										

Refer to owner's manual for towing capabilities and limitations.

Ball Mount

The ball mount is placed inside the opening of the receiver hitch which is mounted to the vehicle. Make sure a hitch pin and clip is properly securing the ball mount to the receiver hitch before you begin towing.

- A: Rise. B: Drop. C: Hole Size. D: Length.

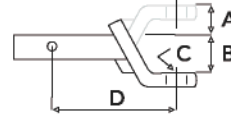

Trailer Ball

The connection from the hitch to the trailer. There are many factors that determine the correct hitch ball:

- Number one is the hitch ball's gross trailer weight rating.
- The mounting platform must be at least 3/8" thick.
- The hole diameter must not be more than 1/16" larger than the threaded shank.
- Every time you tow, check the nut and lock washer to make sure they are fastened securely.
- A: Ball Dia. B: Shank Dia. C: Shank Length. D: Shank Rise.

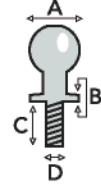

Coupler

The component that is placed over the trailer ball to connect the vehicle to the trailer. Be sure that the coupler size matches the size of the hitch ball and that the coupler handle is securely fastened. To determine what size hitch ball you need for your application you will need to know the size of coupler that is on the trailer. Be sure your coupler is properly adjusted to the ball you are using.

NOTE: For added security the use of safety devices such as Coupler Safety Pins and Locks is strongly recommended.

Safety Chains

Safety chains are a requirement and should be crossed under the tongue of the trailer so that the tongue will not drop to the road if it becomes separated from the hitch. Always leave enough slack so you can turn. Never allow the safety chains to drag on the ground and never attach the chains to the bumper.

Trailer Classification: Safety Chain Breaking Force - Minimum

Class 1: 2,000 lbs. (8.9 kN)

Class 2: 3,500 lbs. (15.6 kN)

Class 3: 5,000 lbs. (22.2 kN)

The strength rating of each length of safety chain or its equivalent and its attachments shall be equal to or exceed in minimum breaking force the GVWR (Gross Vehicle Weight Rating) of the trailer.

Electrical

Trailer lights, Electric Brakes, Break-away systems - Every time you tow, be sure to check that all components are working properly.

Wiring identification by color:

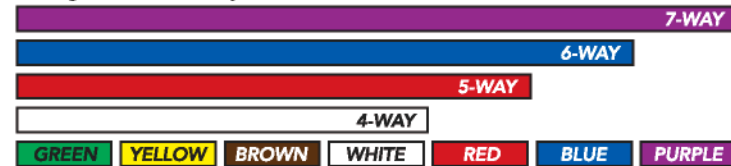

11396

NISSAN LEAF

GROSS LOAD CAPACITY WHEN USED AS A WEIGHT CARRYING HITCH: 1,500 LBS. TRAILER WEIGHT & 150 LBS. TONGUE WEIGHT.

DO NOT EXCEED VEHICLE MANUFACTURER'S RECOMMENDED TOWING CAPACITY.

WARNING: ALL NON-TRAILER LOADS APPLIED TO THIS PRODUCT MUST BE SUPPORTED BY 18050 STABILIZING STRAPS.

** FAILURE TO PROPERLY SUPPORT NON-TRAILER LOADS WILL VOID PRODUCT WARRANTY**

Parts List				
ITEM	QTY	PART NUMBER	DESCRIPTION	
1	2	7/16-14	HEX FLANGE NUT	
2	2	7/16-14 x 1 1/2	CARRIAGE BOLT	
3	2	7_16 FISHWIRE	7/16" FISHWIRE	
4	2	CM-SP2	.250 x .88 x 2.25" SQUARE HOLE SPACER	
5	3	M10 - 1.25 HEX FLANGE NUT	HEX FLANGE NUT	

TOOLS REQUIRED
RATCHET
TORQUE WRENCH
10, 12, 16, 17, 19mm SOCKET
11/16" SOCKET
6" EXTENSION
SCREW DRIVER
DIE GRINDER
DRILL
1/2" DRILL BIT
ROTARY TOOL
SAFETY GLASSES

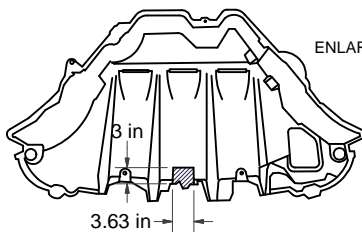

UNDERBODY PANEL TRIM DIAGRAM

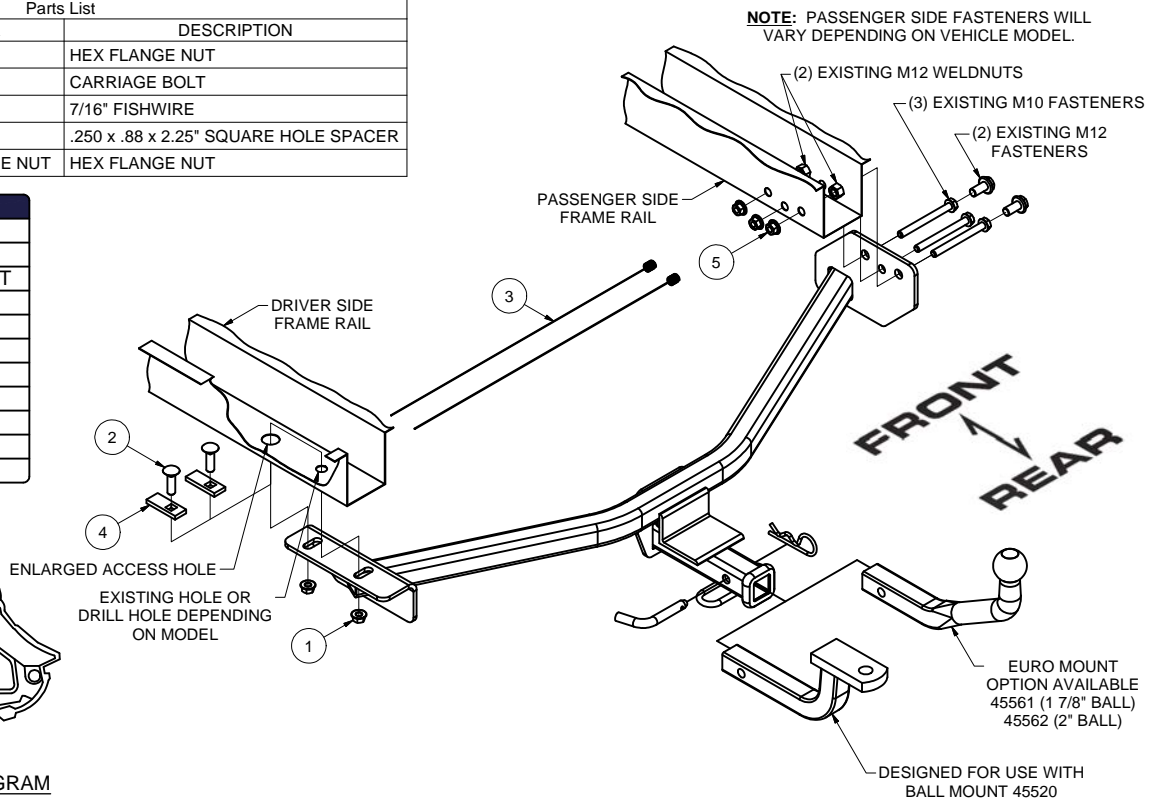

HITCH WEIGHT: 22 LBS.

INSTALL TIME

PROFESSIONAL: 35 MINUTES

NOVICE (DIY): 70 MINUTES

INSTALL NOTES:

- PART REMOVAL
- HOLE ENLARGEMENT
- DRILL HOLE
- FISHWIRE HARDWARE
- TRIM UNDERBODY PANEL

FISHWIRE TECHNIQUE

INSERT COILED END OF FISHWIRE TOOL THROUGH HITCH MOUNTING HOLE IN VEHICLE FRAME RAIL AND OUT THE ACCESS HOLE. PASS COILED END OF FISHWIRE THROUGH SPACER AND THREAD BOLT INTO COIL. KINK WIRE TO KEEP SPACER SEPERATE FROM BOLT AS SHOWN. PULL FISHWIRE, SPACER, AND BOLT THROUGH FRAME AND OUT MOUNTING HOLE. USE FISHWIRE TO GUIDE HITCH DURING MOUNTING AND PREVENT LOSS OF BOLT / SPACER INSIDE FRAME RAIL.

ACCESS HOLE
MOUNTING HOLE

NOTE: SOME VEHICLES MAY FISHWIRE THROUGH END OF FRAME

REVERSE PULL FISHWIRE TECHNIQUE

ATTACH FISHWIRE TO CARRIAGE BOLT AND SLIDE SPACER ONTO FISHWIRE. PUSH THE BOLT THRU THE HOLE FOLLOWED BY THE SPACER (AS SHOWN). PULL BOLT BACK INTO POSITION, PROTRUDING FROM THE FRAME.

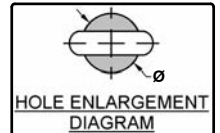

INSTALLATION STEPS

1. Remove the fasteners securing the underbody panel. Retain underbody panel and fasteners for reinstallation.
2. Depending on the model, remove either (4) M12 bolts or (3) M10 bolts securing the tow loop to the passenger side frame rail. Retain (2) M12 bolts or (3) M10 bolts for reinstallation. Return the tow loop and (2 of the 4) M12 bolts to the owner.
3. If the rear-most driver side hole is not present, raise the hitch into position and mark the hole to be drilled. Lower the hitch and drill marked hole. **Note:** Before drilling hole make sure all existing holes are aligned.
4. Enlarge the driver side access hole to allow 7/16" hardware to pass through.
5. Fishwire the 7/16" carriage bolt and SP2 spacer through the enlarged access hole and out the rear-most hole.
6. Reverse fishwire the 7/16" carriage bolt and SP2 spacer into the enlarged access hole.
7. Raise the hitch into position and secure the driver side using the provided 7/16" flange nuts. Secure the passenger side with either the existing (2) M12 bolts into the existing weldnuts in the side of the frame or the existing (3) M10 bolts through the frame rail and secure using the provided M10 flange nuts, as shown.
8. Torque all 7/16" hardware to 70 ft-lbs. Torque all M10 hardware to 48 ft-lbs. Torque all M12 hardware to 90 ft-lbs.
9. Trim underbody panel. See Trim Diagram
10. Reinstall underbody panel using hardware removed in Step (1).

PERIODICALLY CHECK THIS RECEIVER HITCH TO ENSURE THAT ALL FASTENERS ARE TIGHT AND THAT ALL STRUCTURAL COMPONENTS ARE SOUND.