



Safety glasses should be worn at all times while installing this product.

YEARS: 2013

MAKE: HONDA

MODEL: ACCORD



STYLE: ALL

WARNING: NEVER EXCEED YOUR VEHICLE MANUFACTURER'S RECOMMENDED TOWING CAPACITY

WEIGHT CARRYING:
 TRAILER WEIGHT: 2,000 LBS.
 TONGUE WEIGHT: 200 LBS.

INSTALLATION TIME: PRO: 30 MIN.
 NOVICE: 60 MIN.
 THE INSTALL TIME LISTED IS FOR PROFESSIONAL INSTALLERS. IF YOU ARE HESITANT TO UNDERTAKE THIS TASK ON YOUR OWN, CONTACT AN AUTHORIZED CURT INSTALLER FOR ADDITIONAL ASSISTANCE.



INSTALLATION REQUIRES:

 PRY BAR	 RATCHET	 10mm 9/16" 11/16" SOCKET
 TORQUE WRENCH	 AVIATION SHEARS	 TAPE MEASURE
 SAFETY GLASSES		

INSTALLATION TIPS:

- BEFORE YOU BEGIN INSTALLATION, READ ALL INSTRUCTIONS THOROUGHLY.
- TO EASE INSTALLATION, 2 PEOPLE MAY BE REQUIRED.
- USING PROPER TOOLS WILL GREATLY IMPROVE THE QUALITY OF THE INSTALL AND REDUCE THE TIME REQUIRED.

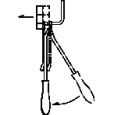
LEVEL OF DIFFICULTY: MODERATE

EASY	MODERATE	CHALLENGING
	- NO DRILLING REQUIRED	
	- LOWER EXHAUST	
	- TRIM HEAT SHIELD(S)	

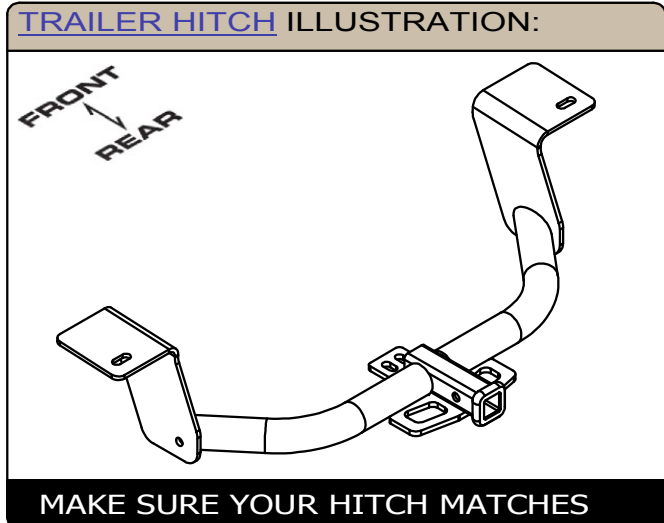

PERIODICALLY CHECK THIS RECEIVER HITCH TO ENSURE ALL FASTENERS ARE TIGHT AND ALL STRUCTURAL COMPONENTS ARE SOUND
 CURT Manufacturing LLC. warrants this product to be free of defects in material and/or workmanship at the time of retail purchase by the original purchaser. If the product is found to be defective, Curt Manufacturing LLC. may repair or replace the product at their option, when the product is returned, prepaid, with proof of purchase. Alteration to, misuse of, or improper installation of this product voids the warranty. Curt Manufacturing LLC.'s liability is limited to repair or replacement of products found to be defective, and specifically excludes liability for incidental or consequential loss or damage.

INSTALLATION WALKTHROUGH:

Parts List			
ITEM	QTY	PART NUMBER	DESCRIPTION
1	2	7/16-14 x 1 1/4	CARRIAGE BOLT
2	2	CM-SP2	.250 x .88 x 2.25" SQUARE HOLE SPACER
3	2	7/16-14	HEX FLANGE NUT
4	1	3_8 - 16 x 1.00 x 1.88	U-BOLT
5	2	HFN3816	HEX FLANGE NUT
6	2	7_16 FISHWIRE	7/16" FISHWIRE

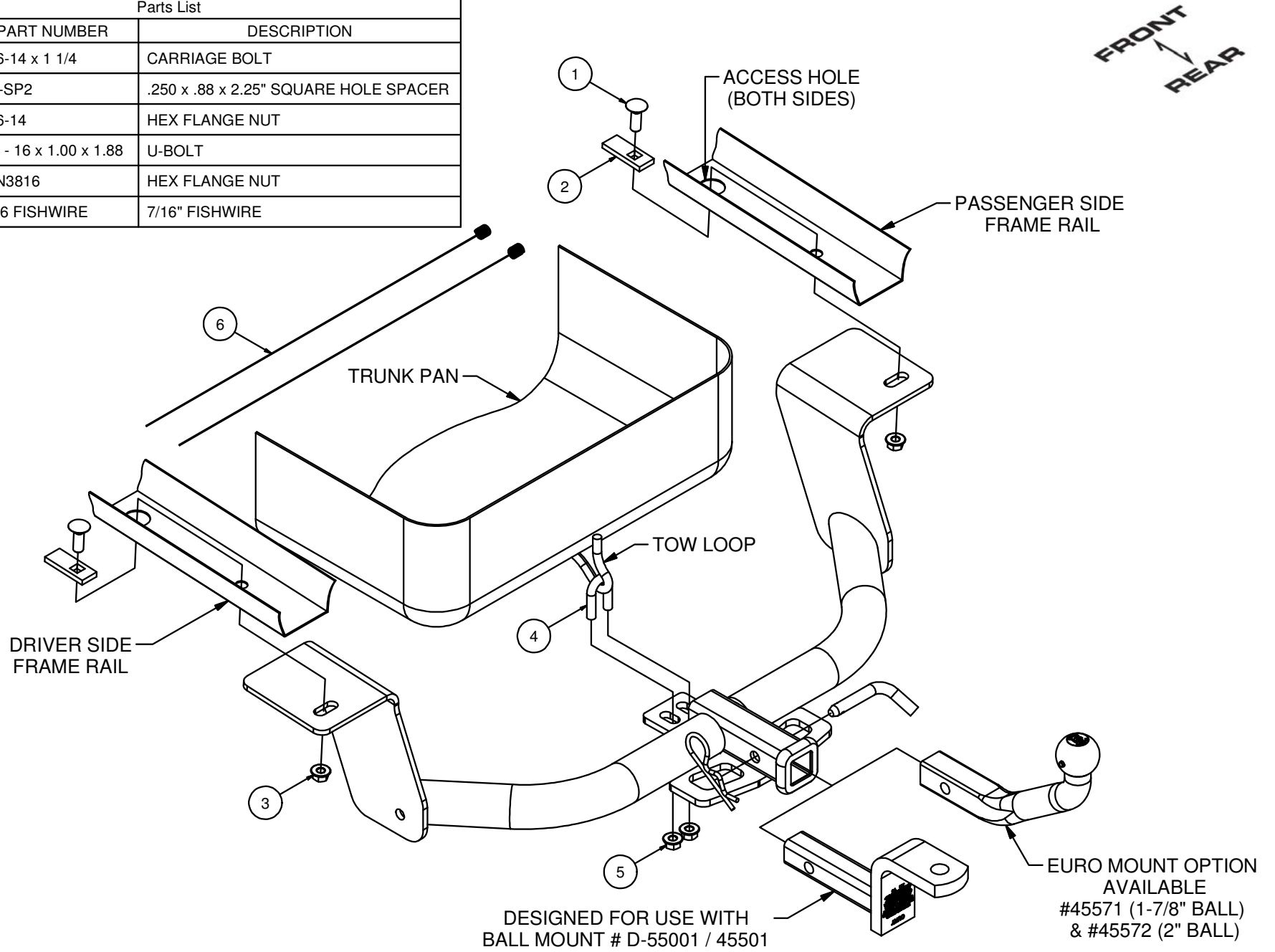

INSTALLATION WALKTHROUGH:

1. Lower exhaust by removing two rubber exhaust isolators for single exhaust vehicles and three isolators for dual exhaust vehicles. See RUBBER ISOLATOR REMOVAL DIAGRAM below.

RUBBER ISOLATOR REMOVAL DIAGRAM

This technique can be used if an Exhaust Hanger Removal Pliers is not available.

Using a 5/8" open end wrench, slide the wrench up to the rubber isolator, cradling the hanger rod as shown. Next place the flat edge of a pry bar between the wrench and the hanger stop or hanger rod. Then simply rotate the pry bar toward the wrench to remove the rubber isolator.

Note: Using a spray lubricant or soapy water on the hanger rod and the rubber isolator helps removal.

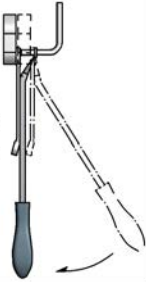

2. Remove heat shield(s) by removing four fasteners per shield. Save fasteners for reinstallation.

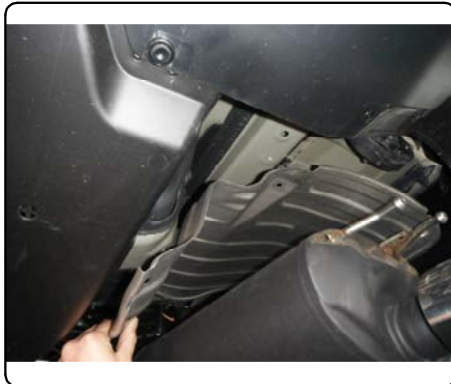
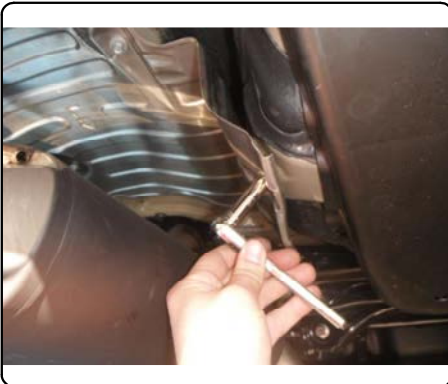

3. Fishwire 7/16"-14 x 1 1/4" carriage bolts with CM-SP2 spacers into position through access holes in both frame rails, as shown on page 1. See FISHWIRE TECHNIQUE DIAGRAM below. **NOTE:** Leave fishwires attached to prevent loss of hardware inside of frame rail.

FISHWIRE TECHNIQUE

INSERT COILED END OF FISHWIRE TOOL THROUGH HITCH MOUNTING HOLE IN VEHICLE FRAME RAIL AND OUT THE ACCESS HOLE. PASS COILED END OF FISHWIRE THROUGH SPACER AND THREAD BOLT INTO COIL. KINK WIRE TO KEEP SPACER SEPERATE FROM BOLT AS SHOWN. PULL FISHWIRE, SPACER, AND BOLT THROUGH FRAME AND OUT MOUNTING HOLE. USE FISHWIRE TO GUIDE HITCH DURING MOUNTING AND PREVENT LOSS OF BOLT / SPACER INSIDE FRAME RAIL.

*NOTE: SOME VEHICLES MAY FISHWIRE THROUGH END OF FRAME**

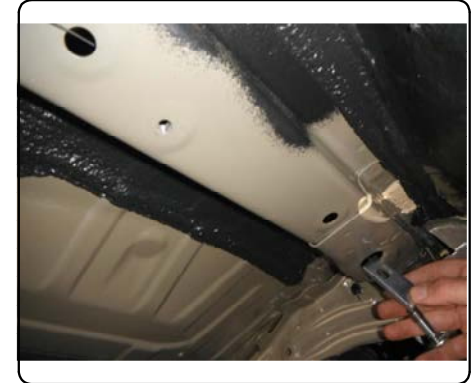
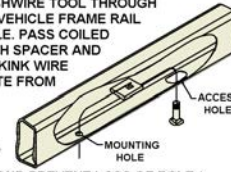

4. Insert 3/8" U-bolt through tow hook, as shown.



INSTALLATION WALKTHROUGH:

5. Insert fishwires through mounting holes in hitch and raise hitch into position. Secure it to the U-bolt with 3/8"-16 hex flange nuts. Remove fishwires and attach 7/16"-14 hex flange nuts to the carriage bolts.



6. Torque all 7/16" hardware to 70 ft-lbs and 3/8" hardware to 45 ft-lbs.

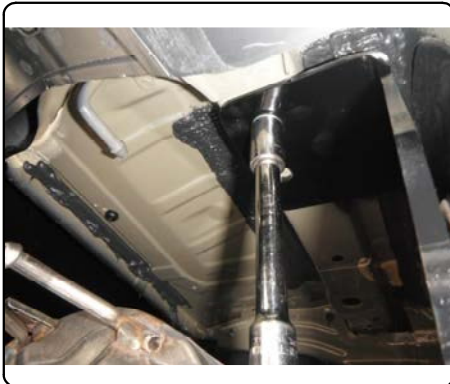

7. Trim heat shield(s) around hitch. Reinstall heat shield(s) with hardware removed in Step 2. **NOTE:** One fastener per shield will not be reinstalled. See HEAT SHIELD TRIMMING DIAGRAM below.

HEAT SHIELD TRIMMING DIAGRAM
NOTE: TRIM DIMENSIONS ARE APPROXIMATE,
CONFIRM FIT PRIOR TO TRIMMING.



8. Raise exhaust and reattach rubber isolators removed in Step 1.
Installation is complete.

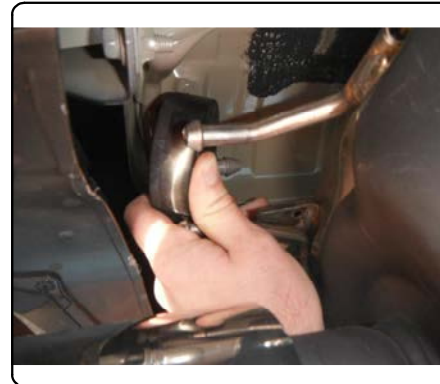

11681

HONDA ACCORD (ALL)

GROSS LOAD CAPACITY WHEN USED AS A WEIGHT CARRYING HITCH: 2,000 LBS. TRAILER WEIGHT & 200 LBS. TONGUE WEIGHT.

DO NOT EXCEED VEHICLE MANUFACTURER'S RECOMMENDED TOWING CAPACITY.

WARNING: ALL NON-TRAILER LOADS APPLIED TO THIS PRODUCT MUST BE SUPPORTED BY 18050 STABILIZING STRAPS.

** FAILURE TO PROPERLY SUPPORT NON-TRAILER LOADS WILL VOID PRODUCT WARRANTY**

Parts List				
ITEM	QTY	PART NUMBER	DESCRIPTION	
1	2	7/16-14 x 1 1/4	CARRIAGE BOLT	
2	2	CM-SP2	.250 x .88 x 2.25" SQUARE HOLE SPACER	
3	2	7/16-14	HEX FLANGE NUT	
4	1	3_8 - 16 x 1.00 x 1.88	U-BOLT	
5	2	HFN3816	HEX FLANGE NUT	
6	2	7_16 FISHWIRE	7/16" FISHWIRE	

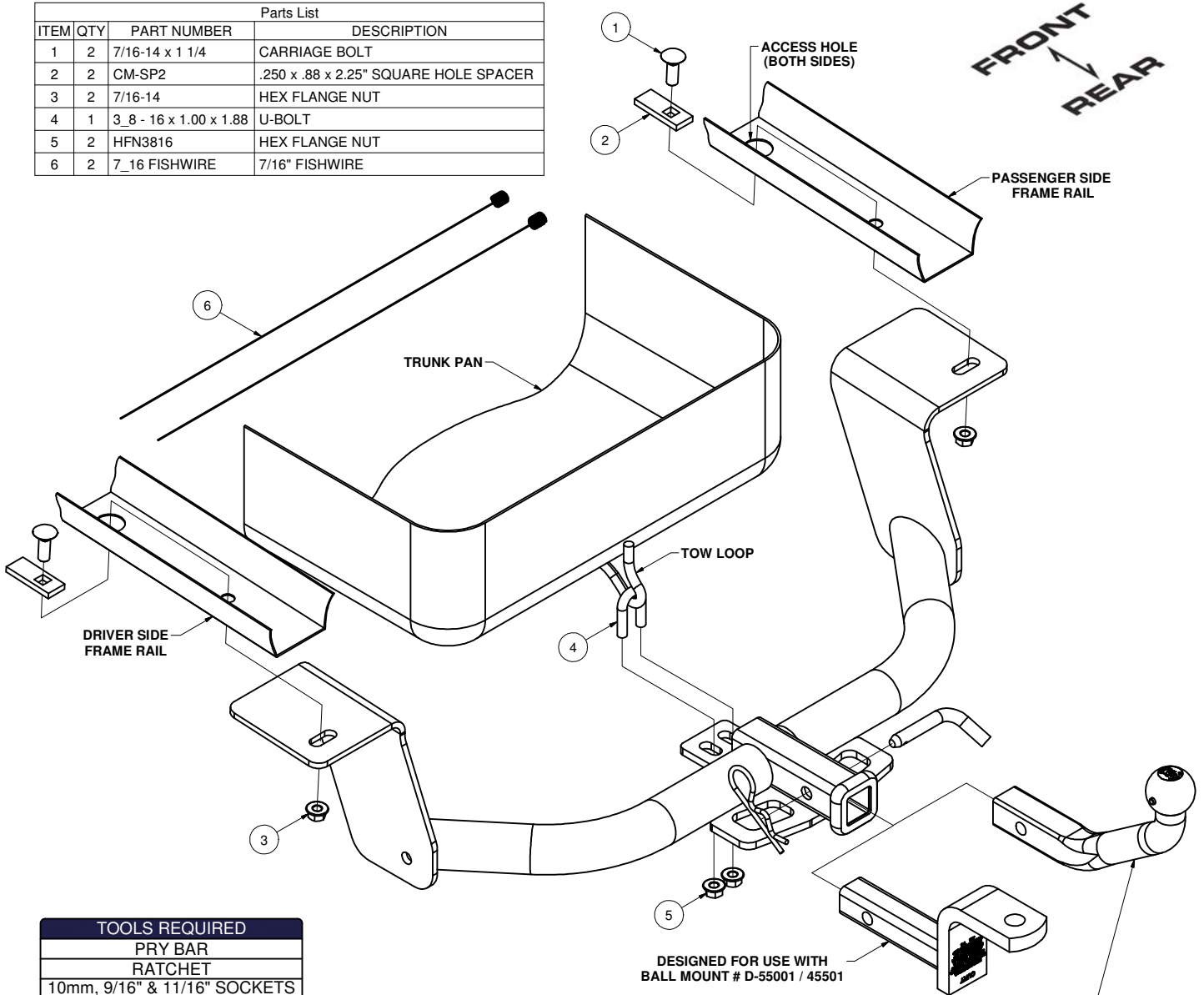

TOOLS REQUIRED
PRY BAR
RATCHET
10mm, 9/16" & 11/16" SOCKETS
TORQUE WRENCH
AVIATION SHEARS
TAPE MEASURE
SAFETY GLASSES

HITCH WEIGHT: 23 LBS.
 INSTALL TIME
 PROFESSIONAL: 30 MINUTES
 NOVICE (DIY): 60 MINUTES
 INSTALL NOTES:
 - NO DRILLING REQUIRED
 - HEAT SHIELD TRIMMING REQUIRED
 - FISHWIRE HARDWARE

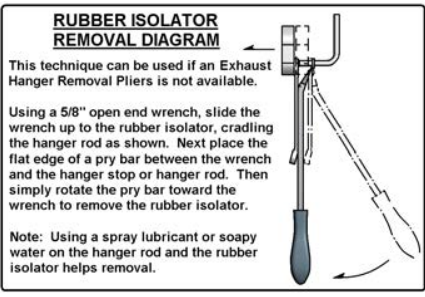

DESIGNED FOR USE WITH BALL MOUNT # D-55001 / 45501

EURO MOUNT OPTION AVAILABLE #45571 (1-7/8" BALL) AND #45572 (2" BALL)

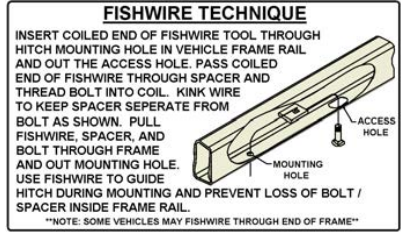

PERIODICALLY CHECK THIS RECEIVER HITCH TO ENSURE THAT ALL FASTENERS ARE TIGHT AND THAT ALL STRUCTURAL COMPONENTS ARE SOUND.

Curt Manufacturing Inc., warrants this product to be free of defects in material and/or workmanship at the time of retail purchase by the original purchaser. If the product is found to be defective, Curt Manufacturing Inc., may repair or replace the product, at their option, when the product is returned, prepaid, with proof of purchase. Alteration to, misuse of, or improper installation of this product voids the warranty. Curt Manufacturing Inc.'s liability is limited to repair or replacement of products found to be defective, and specifically excludes liability for incidental or consequential loss or damage.

11681

HONDA ACCORD (ALL)

GROSS LOAD CAPACITY WHEN USED AS A WEIGHT CARRYING HITCH: 2,000 LBS. TRAILER WEIGHT & 200 LBS. TONGUE WEIGHT.

*****DO NOT EXCEED VEHICLE MANUFACTURER'S RECOMMENDED TOWING CAPACITY.*****

WARNING: ALL NON-TRAILER LOADS APPLIED TO THIS PRODUCT MUST BE SUPPORTED BY AUXILIARY STABILIZING STRAPS.

**** FAILURE TO PROPERLY SUPPORT NON-TRAILER LOADS WILL VOID PRODUCT WARRANTY****

HEAT SHIELD TRIMMING DIAGRAM

NOTE: TRIM DIMENSIONS ARE APPROXIMATE, CONFIRM FIT PRIOR TO TRIMMING.

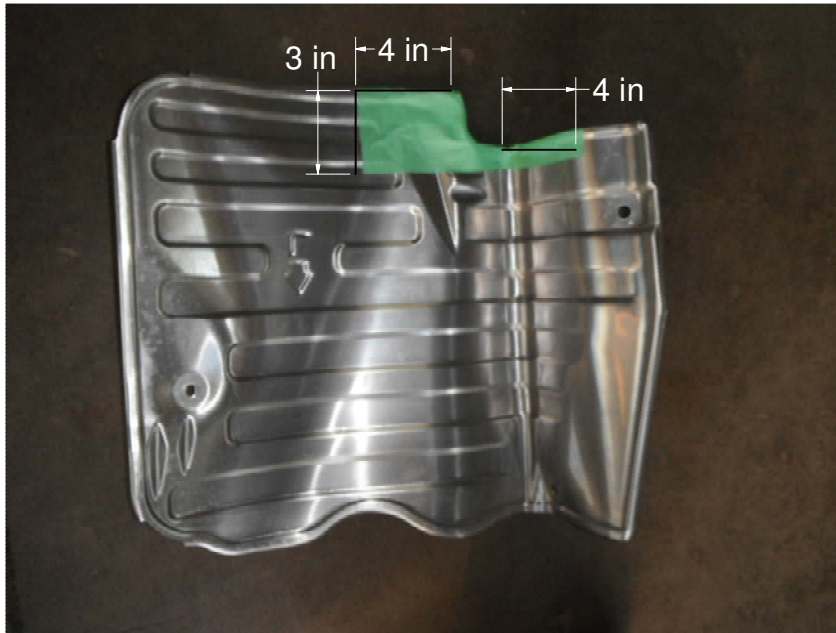

INSTALLED HITCH POSITION

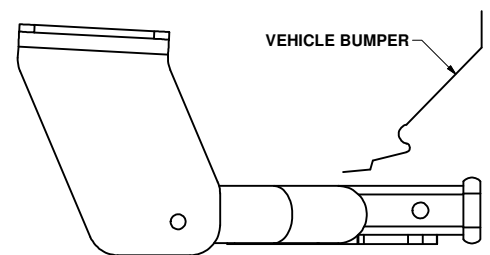

INSTALLATION STEPS

1. Lower exhaust by removing two rubber exhaust isolators for single exhaust vehicles and three isolators for dual exhaust vehicles. See RUBBER ISOLATOR REMOVAL DIAGRAM on page 1.
2. Remove heat shield(s) by removing four fasteners per shield. Save fasteners for reinstallation.
3. Fishwire 7/16"-14 x 1 1/4" carriage bolts with CM-SP2 spacers into position through access holes in both frame rails, as shown on page 1. See FISHWIRE TECHNIQUE DIAGRAM on page 1. **NOTE:** Leave fishwires attached to prevent loss of hardware inside of frame rail.
4. Insert 3/8" U-bolt through tow hook, as shown on page 1.
5. Insert fishwires through mounting holes in hitch and raise hitch into position. Secure it to the U-bolt with 3/8"-16 hex flange nuts. Remove fishwires and attach 7/16"-14 hex flange nuts to the carriage bolts.
6. Torque all 7/16" hardware to 70 ft-lbs and 3/8" hardware to 45 ft-lbs.
7. Trim heat shield(s) around hitch. Reinstall heat shield(s) with hardware removed in Step 2. **NOTE:** One fastener per shield will not be reinstalled. See HEAT SHIELD TRIMMING DIAGRAM above.
8. Raise exhaust and reattach rubber isolators removed in Step 1.

PERIODICALLY CHECK THIS RECEIVER HITCH TO ENSURE THAT ALL FASTENERS ARE TIGHT AND THAT ALL STRUCTURAL COMPONENTS ARE SOUND.

Curt Manufacturing Inc., warrants this product to be free of defects in material and/or workmanship at the time of retail purchase by the original purchaser. If the product is found to be defective, Curt Manufacturing Inc., may repair or replace the product, at their option, when the product is returned, prepaid, with proof of purchase. Alteration to, misuse of, or improper installation of this product voids the warranty. Curt Manufacturing Inc.'s liability is limited to repair or replacement of products found to be defective, and specifically excludes liability for incidental or consequential loss or damage.