



Safety glasses should be worn at all times while installing this product.

YEARS: 2003-PRESENT

MAKE: TOYOTA

MODEL: COROLLA

STYLE: SEDAN





**WARNING: NEVER EXCEED YOUR VEHICLE MANUFACTURER'S RECOMMENDED TOWING CAPACITY**

**WEIGHT CARRYING:**  
 TRAILER WEIGHT: 2,000 LBS.  
 TONGUE WEIGHT: 200 LBS.

**PRO INSTALL TIME: 10 MIN.**  
**NOVICE INSTALL TIME: 20 MIN.**

IF YOU ARE HESITANT TO UNDERTAKE THIS TASK ON YOUR OWN, CONTACT AN AUTHORIZED CURT INSTALLER FOR ADDITIONAL ASSISTANCE.

**INSTALLATION REQUIRES:**

 RATCHET	 TORQUE WRENCH	 19mm SOCKET
 9" SOCKET EXTENSION	 SAFETY GLASSES	

**INSTALLATION TIPS:**

- BEFORE YOU BEGIN INSTALLATION, READ ALL INSTRUCTIONS THOROUGHLY.
- TO EASE INSTALLATION, 2 PEOPLE MAY BE REQUIRED.
- USING PROPER TOOLS WILL GREATLY IMPROVE THE QUALITY OF THE INSTALL AND REDUCE THE TIME REQUIRED.

**LEVEL OF DIFFICULTY: EASY**

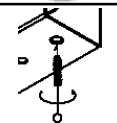
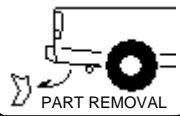
EASY	MODERATE	CHALLENGING
	- NO DRILLING REQUIRED	
	- CLEAN EXISTING WELDNUTS	
	- REMOVE TOW LOOP(S) (IF PRESENT)	

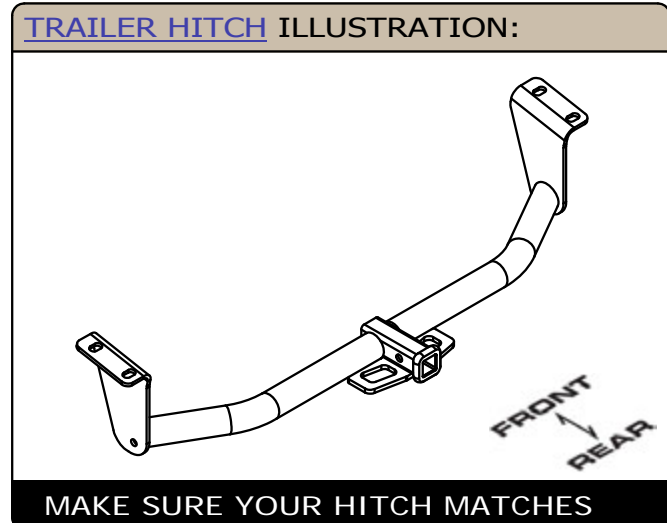

**PERIODICALLY CHECK THIS RECEIVER HITCH TO ENSURE ALL FASTENERS ARE TIGHT AND ALL STRUCTURAL COMPONENTS ARE SOUND**

CURT Manufacturing LLC. warrants this product to be free of defects in material and/or workmanship at the time of retail purchase by the original purchaser. If the product is found to be defective, Curt Manufacturing LLC. may repair or replace the product at their option, when the product is returned, prepaid, with proof of purchase. Alteration to, misuse of, or improper installation of this product voids the warranty. Curt Manufacturing LLC.'s liability is limited to repair or replacement of products found to be defective, and specifically excludes liability for incidental or consequential loss or damage.

## INSTALLATION WALKTHROUGH:

Parts List			
ITEM	QTY	PART NUMBER	DESCRIPTION
1	4	M12-1.25 x 30mm	HEX BOLT
2	4	1/2	CONICAL TOOTHED WASHER

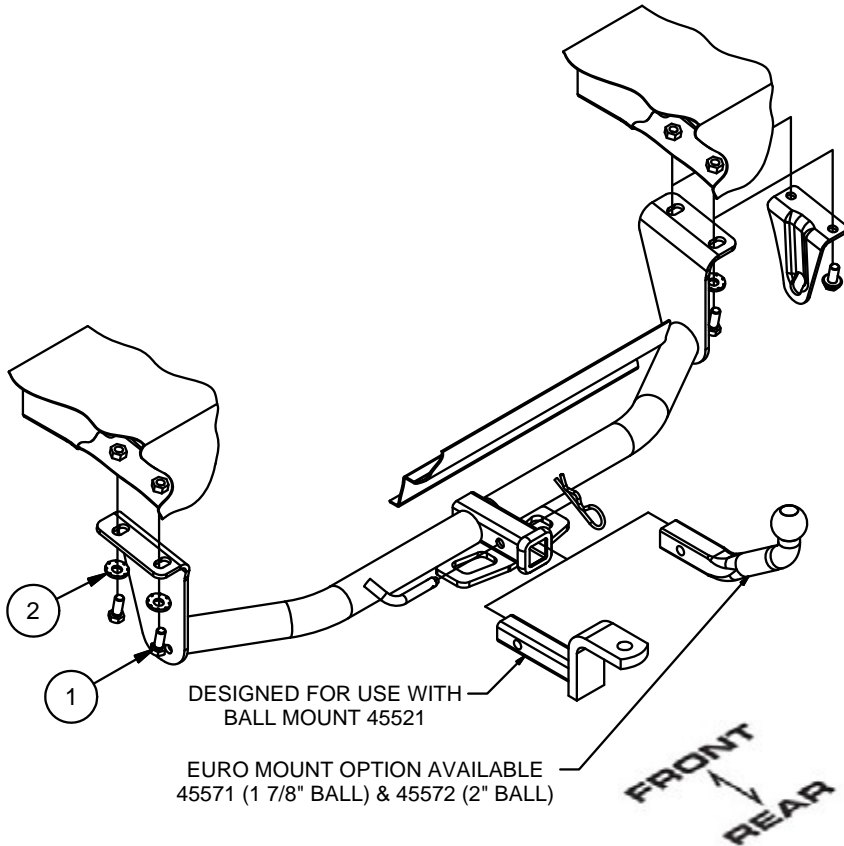

### CONICAL TOOTHED WASHER ORIENTATION DIAGRAM

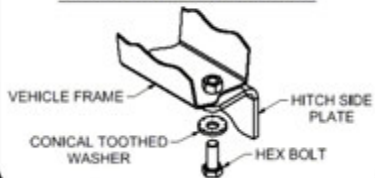

### WELDNUT CLEANING

To remove debris from weldnuts in frame, spray lubricant or compressed air into hole. For heavy debris, use a small wire brush. (Be careful not to damage threads).

1. If present, remove existing bolts from tow loop(s). Return tow loop(s) and bolts to owner.

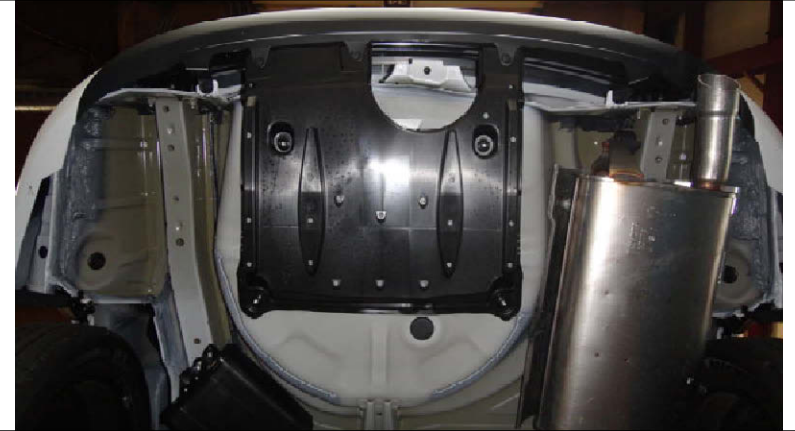

2. Raise hitch into position and align the holes in the side plates with the weldnuts in the frame rails. Secure the hitch using M12-1.25 x 30mm hex bolts and 1/2" conical toothed washers.



## INSTALLATION WALKTHROUGH:

3. Torque all M12 hardware to 86 ft-lbs.



INSTALLATION COMPLETE



11265

TOYOTA COROLLA

GROSS LOAD CAPACITY WHEN USED AS A WEIGHT CARRYING HITCH: 2,000 LBS. TRAILER WEIGHT & 200 LBS. TONGUE WEIGHT.

\*\*\*DO NOT EXCEED VEHICLE MANUFACTURER'S RECOMMENDED TOWING CAPACITY.\*\*\*

WARNING: ALL NON-TRAILER LOADS APPLIED TO THIS PRODUCT MUST BE SUPPORTED BY 18050 STABILIZING STRAPS.

\*\* FAILURE TO PROPERLY SUPPORT NON-TRAILER LOADS WILL VOID PRODUCT WARRANTY\*\*

Parts List			
ITEM	QTY	PART NUMBER	DESCRIPTION
1	4	M12-1.25 x 30mm	HEX BOLT
2	4	1/2	CONICAL TOOTHED WASHER

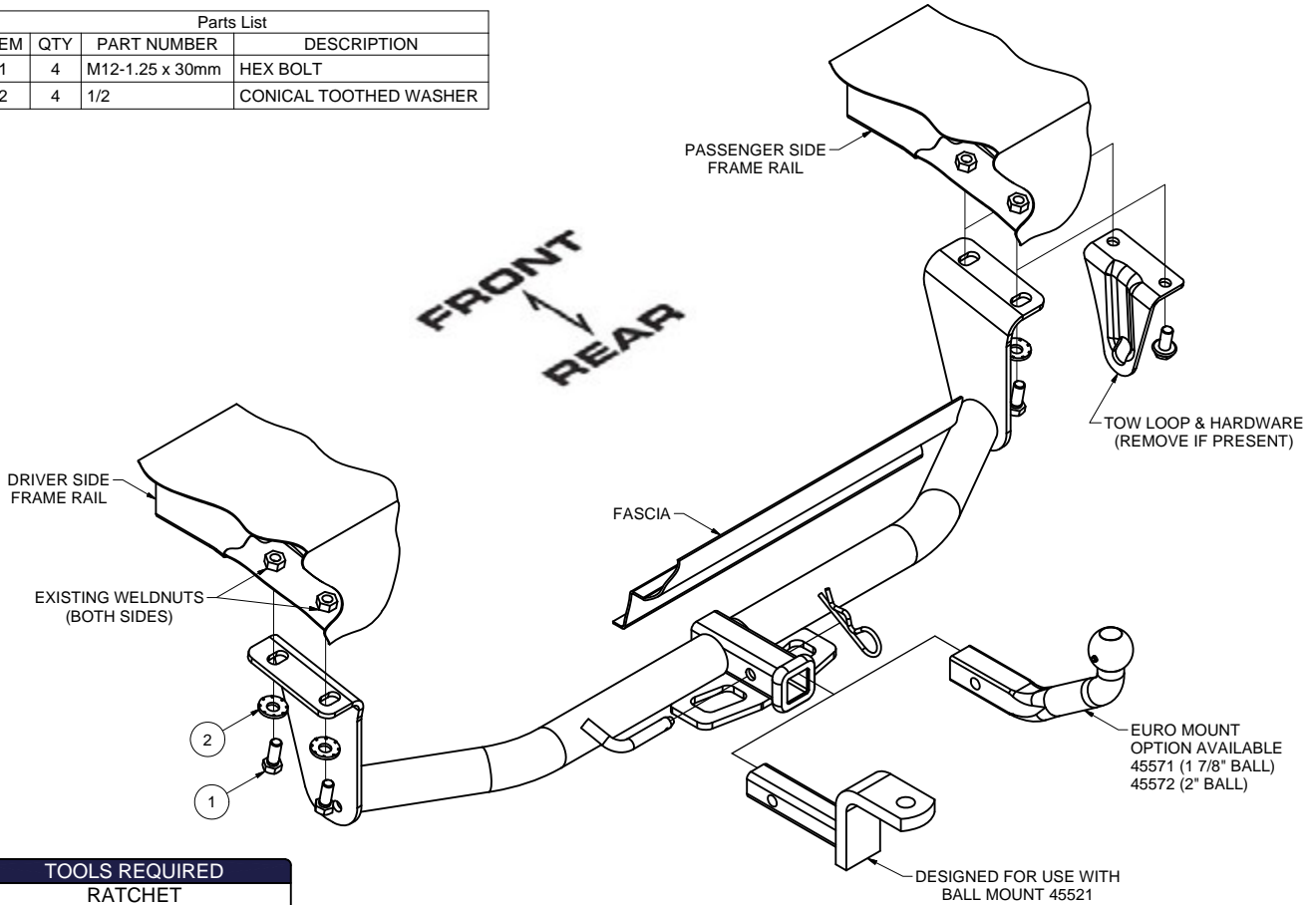

TOOLS REQUIRED	
RATCHET	
TORQUE WRENCH	
19mm SOCKET	
9" EXTENSION	
SAFETY GLASSES	

HITCH WEIGHT: 20 LBS.  
 INSTALL TIME  
 PROFESSIONAL: 10 MINUTES  
 NOVICE (DIY): 20 MINUTES  
 INSTALL NOTES:  
 - NO DRILLING  
 - REMOVE TOW LOOP (IF PRESENT)

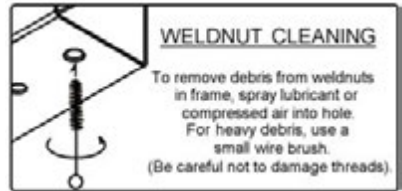
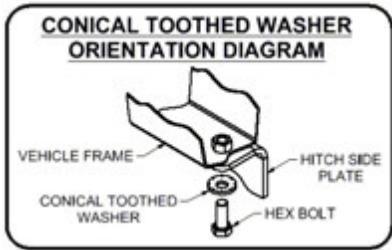

INSTALLATION STEPS

1. If present, remove existing bolts from tow loop(s). Return tow loop(s) and bolts to owner.
2. Raise hitch into position and align the holes in the side plates with the weldnuts in the frame rails. Secure the hitch using M12-1.25 x 30mm hex bolts and 1/2" conical toothed washers.
3. Torque all M12 hardware to 86 ft-lbs.

PERIODICALLY CHECK THIS RECEIVER HITCH TO ENSURE THAT ALL FASTENERS ARE TIGHT AND THAT ALL STRUCTURAL COMPONENTS ARE SOUND.

Curt Manufacturing LLC., warrants this product to be free of defects in material and/or workmanship at the time of retail purchase by the original purchaser. If the product is found to be defective, Curt Manufacturing LLC., may repair or replace the product, at their option, when the product is returned, prepaid, with proof of purchase. Alteration to, misuse of, or improper installation of this product voids the warranty. Curt Manufacturing LLC.'s liability is limited to repair or replacement of products found to be defective, and specifically excludes liability for incidental or consequential loss or damage.