



Safety glasses should be worn at all times while installing this product.

YEARS: 2012-CURRENT

MAKE: VOLKSWAGEN

MODEL: BEETLE (EXCLUDING GAS TURBO)

STYLE: HATCHBACK





**WARNING: NEVER EXCEED YOUR VEHICLE MANUFACTURER'S RECOMMENDED TOWING CAPACITY**

**WEIGHT CARRYING:**  
 TRAILER WEIGHT: 1,500 LBS.  
 TONGUE WEIGHT: 150 LBS.

**INSTALLATION TIME: 15 MIN.**

THE INSTALL TIME LISTED IS FOR PROFESSIONAL INSTALLERS. IF YOU ARE HESITANT TO UNDERTAKE THIS TASK ON YOUR OWN, CONTACT AN AUTHORIZED CURT INSTALLER FOR ADDITIONAL ASSISTANCE.



**INSTALLATION REQUIRES:**

 RATCHET	 TORQUE WRENCH	 18mm 19mm 3/4"
 10" SOCKET EXTENSION	 SAFETY GLASSES	

**INSTALLATION TIPS:**

- BEFORE YOU BEGIN INSTALLATION, READ ALL INSTRUCTIONS THOROUGHLY.
- TO EASE INSTALLATION, 2 PEOPLE MAY BE REQUIRED.
- USING PROPER TOOLS WILL GREATLY IMPROVE THE QUALITY OF THE INSTALL AND REDUCE THE TIME REQUIRED.

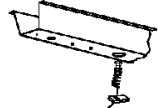
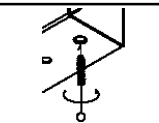
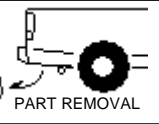
**LEVEL OF DIFFICULTY: EASY**

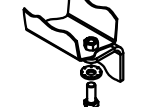
EASY	MODERATE	CHALLENGING
	REVERSE FISHWIRE HARDWARE	
	CLEAN EXISTING WELDNUTS	
	REMOVE EXISTING BOLT	
	NO DRILLING REQUIRED	
	CONICAL TOOTHED WASHER ORIENTATION	

**VEHICLE PHOTO:**



REPRESENTATIVE PHOTO

**TRAILER HITCH ILLUSTRATION:**

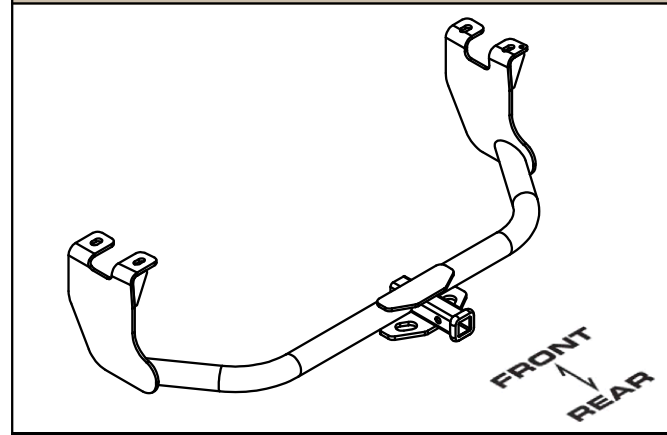

MAKE SURE YOUR HITCH MATCHES

**PERIODICALLY CHECK THIS RECEIVER HITCH TO ENSURE ALL FASTENERS ARE TIGHT AND ALL STRUCTURAL COMPONENTS ARE SOUND**

CURT Manufacturing LLC. warrants this product to be free of defects in material and/or workmanship at the time of retail purchase by the original purchaser. If the product is found to be defective, Curt Manufacturing LLC. may repair or replace the product at their option, when the product is returned, prepaid, with proof of purchase. Alteration to, misuse of, or improper installation of this product voids the warranty. Curt Manufacturing LLC.'s liability is limited to repair or replacement of products found to be defective, and specifically excludes liability for incidental or consequential loss or damage.

## INSTALLATION WALKTHROUGH:

Parts List			
ITEM	QTY	PART NUMBER	DESCRIPTION
1	2	CM-SP17	.250 x 1.25 x 2.50" SQUARE HOLE SPACER
2	2	7/16"	CONICAL TOOTHED WASHER
3	2	M12-1.5 x 35mm	HEX BOLT
4	2	1/2-13 x 1 1/2	CARRIAGE BOLT
5	2	HFN 1213	HEX FLANGE NUT
6	2	1_2 FISHWIRE	1/2" FISHWIRE

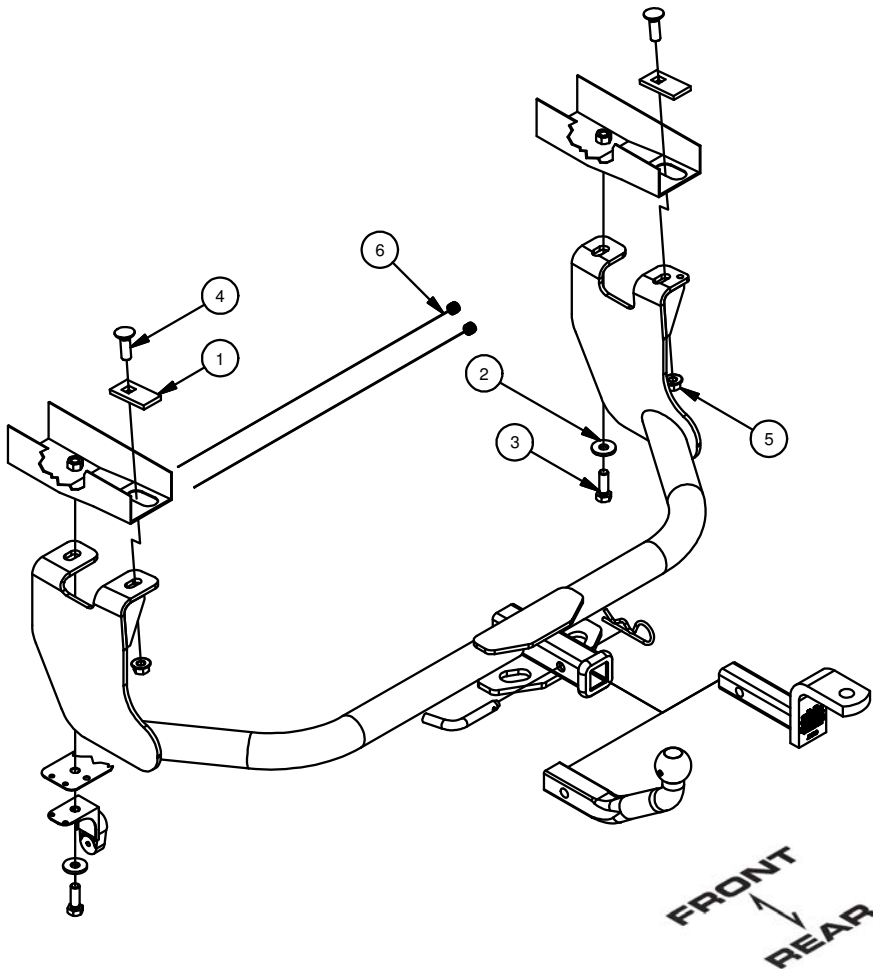

1. Remove existing bolt from driver side exhaust hanger. Return bolt to vehicle owner.



2. Reverse fishwire 1/2"-13 x 1 1/2" carriage bolts and CM-SP17 spacers into driver and passenger side frame rails.

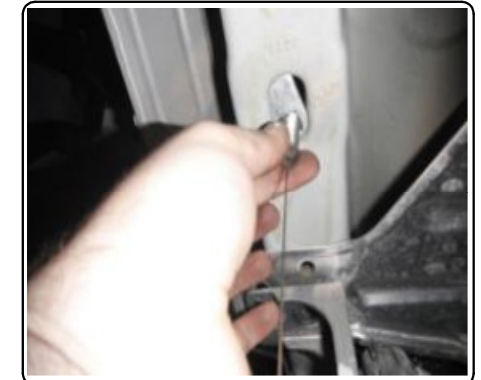

## INSTALLATION WALKTHROUGH:

3. Raise hitch into position with driver side plate flange under driver side heat shield and exhaust hanger. Secure hitch with 1/2"-13 hex flange nuts onto carriage bolts. Thread M12 bolts and 7/16" conical toothed washers into existing weldnuts as shown.



4. Torque 1/2"-13 hardware to 110 lb-ft and M12-1.50 hardware to 83 lb-ft.



**11260****VOLKSWAGEN BEETLE (EXCLUDING GAS TURBO)****4/1/2013****GROSS LOAD CAPACITY WHEN USED AS A WEIGHT CARRYING HITCH: 1,500 LBS. TRAILER WEIGHT & 150 LBS. TONGUE WEIGHT.**

\*\*\*DO NOT EXCEED VEHICLE MANUFACTURER'S RECOMMENDED TOWING CAPACITY.\*\*\*

**WARNING: ALL NON-TRAILER LOADS APPLIED TO THIS PRODUCT MUST BE SUPPORTED BY 18050 STABILIZING STRAPS.**

\*\* FAILURE TO PROPERLY SUPPORT NON-TRAILER LOADS WILL VOID PRODUCT WARRANTY\*\*

## Parts List

ITEM	QTY	PART NUMBER	DESCRIPTION
1	2	CM-SP17	.250 x 1.25 x 2.50" SQUARE HOLE SPACER
2	2	7/16"	CONICAL TOOTHED WASHER
3	2	M12-1.5 x 35mm	HEX BOLT
4	2	1/2-13 x 1 1/2	CARRIAGE BOLT
5	2	HFN 1213	HEX FLANGE NUT
6	2	1_2 FISHWIRE	1/2" FISHWIRE

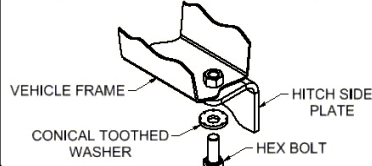
**CONICAL TOOTHED WASHER  
ORIENTATION DIAGRAM****REVERSE PULL FISHWIRE  
TECHNIQUE**

ATTACH FISHWIRE TO CARRIAGE BOLT AND SLIDE SPACER ONTO FISHWIRE. PUSH THE BOLT THRU THE HOLE FOLLOWED BY THE SPACER (AS SHOWN). PULL BOLT BACK INTO POSITION, PROTRUDING FROM THE FRAME.

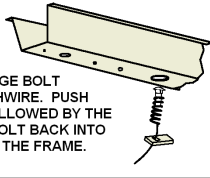
**TOOLS REQUIRED**

RATCHET
TORQUE WRENCH
18mm SOCKET
19mm SOCKET
3/4" SOCKET
10" SOCKET EXTENSION

**WELDNUT CLEANING**

To remove debris from weldnuts in frame, spray lubricant or compressed air into hole. For heavy debris, use a small wire brush. (Be careful not to damage threads.)

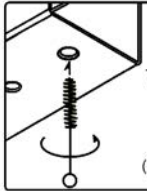

HITCH WEIGHT: .32 LBS.

**INSTALL TIME**

PROFESSIONAL: 15 MINUTES

NOVICE (DIY): 30 MINUTES

**INSTALL NOTES:**

- NO DRILLING REQUIRED
- REVERSE FISHWIRE HARDWARE
- REMOVE EXISTING BOLT

FRAME RAIL

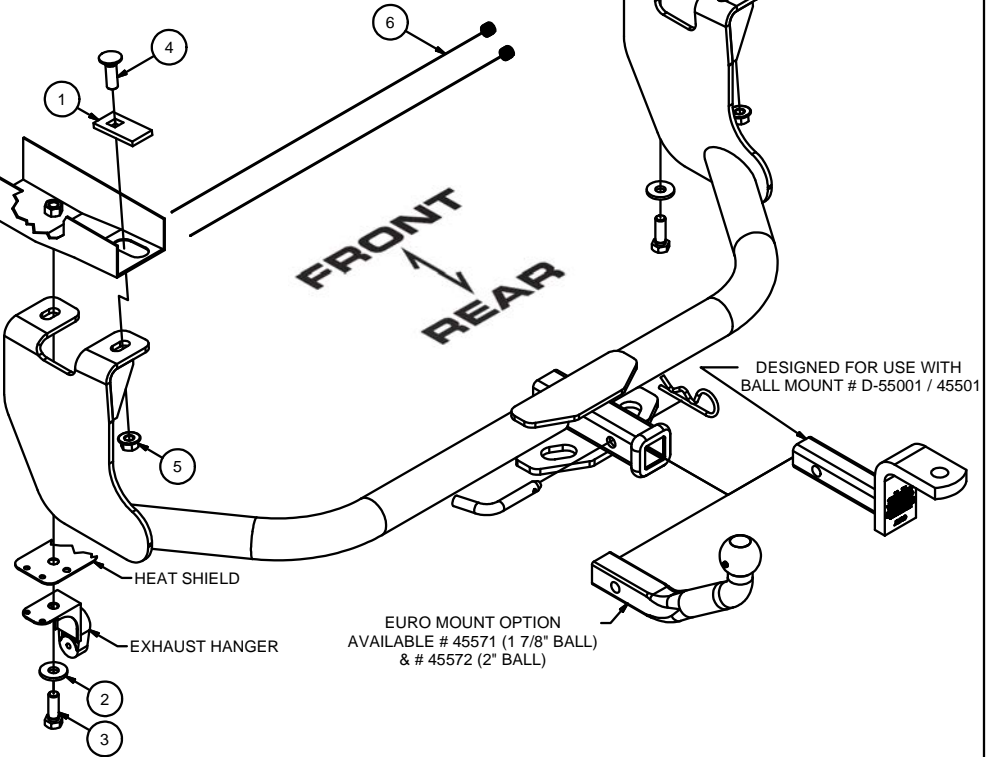

EURO MOUNT OPTION  
AVAILABLE # 45571 (1 7/8" BALL)  
& # 45572 (2" BALL)

**INSTALLATION STEPS**

1. Remove existing bolt from driver side exhaust hanger. Return bolt to vehicle owner.
2. Reverse fishwire 1/2"-13 x 1 1/2" carriage bolts and CM-SP17 spacers into driver and passenger side frame rail.
3. Raise hitch into position with driver side plate flange under driver side heat shield and exhaust hanger.
4. Secure hitch with 1/2"-13 hex flange nuts on fishwired carriage bolts. Thread M12 bolts with 7/16" conical toothed washers into existing weldnuts. Sandwich the driver side flange with the heat shield and exhaust hanger as shown.
5. Torque 1/2"-13 hardware to 110 lb-ft and M12-1.50 hardware to 83 lb-ft.

PERIODICALLY CHECK THIS RECEIVER HITCH TO ENSURE THAT ALL FASTENERS ARE TIGHT AND THAT ALL STRUCTURAL COMPONENTS ARE SOUND.

Curt Manufacturing LLC., warrants this product to be free of defects in material and/or workmanship at the time of retail purchase by the original purchaser. If the product is found to be defective, Curt Manufacturing LLC., may repair or replace the product, at their option, when the product is returned, prepaid, with proof of purchase. Alteration to, misuse of, or improper installation of this product voids the warranty. Curt Manufacturing LLC.'s liability is limited to repair or replacement of products found to be defective, and specifically excludes liability for incidental or consequential loss or damage.