



2018 CATALOG
APPLICATION GUIDES





CURT Group is a leading sales, marketing, engineering and distribution company of towing products and truck accessories for all types of vehicles, from passenger cars to commercial trucks. Our family of brands includes CURT, ARIES, LUVERNE Truck Equipment, UWS and RETRAC.

We are a team of more than 1,000 associates world-wide, with manufacturing plants in Wisconsin, South Dakota, Florida and the Philippines, and 12 regional warehouses across the United States and Canada. We stand for EXCELLENCE in our products and our associates. We aspire to be the industry LEADER by recognizing that the customer is KING and our associates are our greatest ASSET.



CURT is the leading manufacturer of USA-made trailer hitches and a complete line of towing and electrical products. For everything from passenger cars to full-size trucks, our products are tested, proven and safe.



ARIES is a fast-paced marketer and innovator of truck, Jeep, SUV and CUV accessories. From automotive enthusiasts to professional builders, our products are built for the champions of individualism, innovation and attitude.



UWS is a leading manufacturer and designer of USA-made truck tool boxes. Our products are built to the highest quality standards, offering tough and reliable storage solutions for professional tradesmen and truck enthusiasts alike.



LUVERNE is a leading manufacturer of functional aftermarket accessories for pickup trucks, commercial vans and SUVs. We have been manufacturing in the USA since 1963. Our brand is nationally known and respected for quality craftsmanship and hardworking products that get the job done.



RETRAC is a leading manufacturer of OEM and aftermarket mirrors and front-end protection for heavy-duty and medium-duty trucks. Since 1957, our ongoing commitment to innovation and excellence has led RETRAC to mean "Best in Sight" to the trucking industry.



FIRST-TO-MARKET FOCUS

CURT strives for continuous improvement. This not only applies to our products but also to our internal processes as a company. We have always approached our work with a first-to-market focus, and as a result, we are able to deliver top quality products, for more vehicle applications, at an industry-leading rate.

This year, we are excited to introduce several new products, including brake controls, 3" receiver accessories, 5th wheel products and a full line of RV harnesses for dinghy towing.

Each year, we not only develop new, innovative products, but we also put a great deal of effort into our carryover process, expanding the application range of our existing products to cover more and more vehicles. The CURT application guides are constantly expanding.

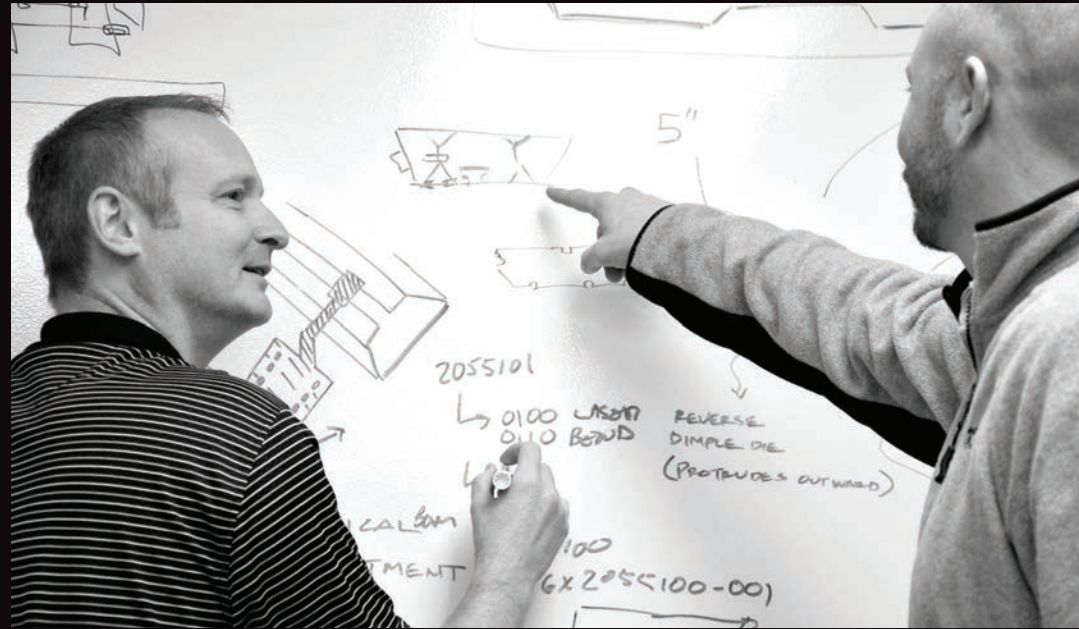

NEW PRODUCTS



Chevrolet / GMC 5th Wheel Roller Adapter

This adapter uses simple quarter-turn anchors to easily drop into the GM puck system and provide a mounting platform for any CURT 5th wheel roller. **Page 300**



5th Wheel Hitch Lock

Compatible with all industry-standard base rails, this lock secures a 5th wheel into the rails without obstruction and operates with a 1/8-turn. **Page 225**



OEM-Style Gooseneck Hitches

Our new OEM-style goose for Ford Super Duty offers a one-person install and is made in the USA. We've also added a new OEM-style goose for Ram. **Page 280**



Light-Duty TruTrack™ & Brackets

We've added a new TruTrack™ WD with integrated sway control rated for 5,000 lbs., as well as new support brackets for wide-frame trailers. **Page 319**



Custom-Fit Trailer Hitches

Custom hitches are at the heart of our new product efforts. We offer many first-to-market designs, in-house testing and an industry-leading finish. **Page 32**



3" Ball Mounts

Fully tested and rated to 21,000 lbs., we have added three new ball mounts to fit 3" x 3" receiver tubes – 4", 6" and 8" drop options. **Page 203**



3" Receiver Tube Accessories

For 3" x 3" receiver tubes, we've added a 21K-rated 5/8" hitch pin and a reducer sleeve set that accepts 2" or 2 1/2" shanks. **Pages 227 and 213**



Tow Hook Mounts

We have added two new tow hook mounts – one for 2" receivers and one for 2 1/2". Both have powder-coated, solid steel construction. **Page 210**



Ratcheting Tray-Style Bike Racks

These new bike racks feature highly secure, key-operated, ratcheting arms that lock down onto the bike frames for safe travel and theft protection. **Page 350**



Spectrum™ Brake Control

This proportional brake control offers an integrated OE look, featuring a control knob that mounts in the dash and has ten tri-color LEDs. **Page 238**



Assure™ Brake Control

This proportional brake control features a high-quality 128 x 64 dot matrix OLED display screen and a pressure-sensitive manual override button. **Page 239**



Potted Enclosures

We've added a new potted converter for water and vibration resistance, and we've introduced more custom wiring harnesses with potted enclosures. **Page 254**



RV Harnesses

We've added a line of towed-vehicle RV harnesses for dinghy towing. They connect the vehicle's taillights to the RV and offer a vehicle-specific fit. **Page 252**



24-Volt Converter

This new taillight converter is designed for use with 24V systems primarily found in busses, trucks and cab-and-chassis systems. **Page 255**



Heavy-Duty Connectors

We have introduced three new heavy-duty 7-way RV blades, including a USCAR socket. The sockets feature a weather-resistant cover. **Page 265**



Coiled Adapters

These adapters feature a coiled extension harness for a farther reach without dragging on the ground. They are available in 7-to-4-way and 7-to-5-way. **Page 259**



Custom Wiring

We continue to advance our plug-and-play, custom wiring line with new technology, like potted housings and many first-to-market applications. **Page 32**

5th wheel, base rails	302
5th wheel, bracket kits	302
5th wheel, hitches	306
5th wheel, lock	311
5th wheel, lube plate	312
5th wheel, OEM-style legs	298
5th wheel, OEM-style roller products	300
5th wheel, rollers	301
5th wheel, accessories	311
Adapter, 4-way flat	256
Adapter, 4-way round	257
Adapter, 6-way round	258
Adapter, 7-way round & RV blade	260
Adapter, Dodge factory harness	246
Adapter, for LED trailer lights	259
Adapter, with LED dust covers	258
Anti-rattle kits	226
Ball mount, 1 1/4" class 1 & 2	199
Ball mount, 1 1/4" euro mounts	198
Ball mount, 2" adjustable	206
Ball mount, 2" class 3	200
Ball mount, 2" class 4	202
Ball mount, 2" dual-length	201
Ball mount, 2" forged	203
Ball mount, 2" fusion mounts	208
Ball mount, 2" loaded	208
Ball mount, 2" multi-ball	207
Ball mount, 2" reversible	207
Ball mount, 2" right angle	201
Ball mount, 2" specialty mount	211
Ball mount, 2" D-ring	210
Ball mount, 2 1/2" Commercial Duty	202
Ball mount, 2 1/2" forged	203
Ball mount, 3" forged	203
Ball mount, ATV	211
Ball mount, channel mount	204
Ball mount, reducer sleeve	213
Ball mount, tongue sleeve	213
Ball mount, towing starter kits	197
Ball mount, tri-ball	206
Ball mount, vertical	209
Bearing protectors	340
Bike rack, accessories	354
Bike rack, clamp-on	354
Bike rack, hitch-mounted, towable	353
Bike rack, tray-style	350
Brake control harnesses	241
Brake controls	237
Breakaway batteries and cases	245
Breakaway kits, push-to-test	244
Cable lock	225
Cargo bags	349
Cargo carrier, ATV	348
Cargo carriers, basket-style	347

Cargo carriers, tray-style	346
Cargo nets	349
Cargo straps	358
Chain, bulk	333
Chain, custom	333
Clevis hooks	335
Converters, taillight	254
Couplers	328
Coupler, latch lock	224
Coupler, trailer lock	224
Custom wiring	246
Electrical, 7-way OEM extensions	250
Electrical, brackets, Easy-Mount	266
Electrical, brackets, mounting	267
Electrical, breakers	271
Electrical, bonded 4-wire spool	269
Electrical, butt connectors	270
Electrical, flashers and fuses	271
Electrical, quick connectors	270
Electrical, slit loom	271
Electrical, snap locks	270
Electrical, tape	271
Electrical, terminals	270
Electrical, testers	269
Extension harness, 7-way RV blade	250
Fabrication components	229
Gooseneck, 5th wheel rail	290
Gooseneck, over-bed fixed ball	288
Gooseneck, over-bed flat plate	288
Gooseneck, over-bed folding ball	288
Gooseneck, over-bed install brkts	289
Gooseneck, OEM-style anchors	276
Gooseneck, OEM-style hitches	280
Gooseneck, Double Lock Original	282
Gooseneck, Double Lock EZr™	278
Gooseneck, Quick Goose II	286
Gooseneck, under-bed folding ball	286
Gooseneck, under-bed install brkts	284
Gooseneck, X5 adapter plates	281
Hitch bars	229
Hitch pins & clips, 1/2" and 5/8"	227
Hitch tube covers	231
Hitch lock	223
Jack, accessories	332
Jack, A-frame and marine	330
Jack, swivel and direct weld	331
Jack, repair parts	332
Lights, towing	268
Lights, trailer	268
Literature	365
Locks	222
Lunette eyes	217
Dual-output sockets, backup alarm	256
Pintle, mounts	215

Pintle, combination and regular	214
Pintle, replacement balls	220
Point-of-purchase, banners	366
Point-of-purchase, display stands	368
Point-of-purchase, display signage	368
Point-of-purchase, planogram	364
Point-of-purchase, posters	366
Point-of-purchase, window stickers	365
Point-of-purchase, header cards	367
Plugs & sockets, 2-way flat	261
Plugs & sockets, 4-way flat	261
Plugs & sockets, 4-way round	262
Plugs & sockets, 5-way flat	263
Plugs & sockets, 6-way round	264
Plugs & sockets, 6-way square	264
Plugs & sockets, 7-way	265
Pro finishing pack	230
Quick links	338
Receiver tube adapters	212
Receiver tube extenders	212
Reducer bushings	213
Roof rack	348
Rope hooks and rings	359
RV harnesses	252
Safety cable	335
Safety chain	334
Safety hooks	337
Safety pins	228
Sway control, unit and repl. Parts	316
Tow bar, adjustable	232
Tow hooks and straps	210
Tow mirror, extended view	233
Trailer balls	218
Trailer ball, covers	220
Trailer ball, replacement parts	220
Trailer ball, switch ball	219
Trailer ball, wrench	220
Trailer hitch, bumper mount	20
Trailer hitch, Commercial Duty	15
Trailer hitch, front mount	16
Trailer hitch, front mount accessory	23
Trailer hitch, multi-fit	17
Trailer hitch, rear mount, app guide	32
Trailer hitch, RV	16
Trailer hitch, universal weld-on	20
Trailer hitch, Xtra Duty	15
USCAR replacement products	247
Weight distribution, TruTrack™	318
Weight distribution, trunnion bar	320
Weight distribution, round bar	322
Weight distribution, repl. shanks	324
Wheel bearing kits	340
Wheel chock lock	226
Winches and straps	339

UNDERSTANDING TOWING

Towing basics and electrical guides

006 - 011

TRAILER HITCHES

Rear and front mount, multi-fit and RV hitches

012 - 029

APPLICATION GUIDE

Hitch and wiring applications listed by make and model

030 - 193

TOWING ACCESSORIES

Ball mounts, trailer balls, locks, pintles and more

194 - 233

TOWING ELECTRICAL

Brake controls, custom wiring, adapters and connectors

234 - 271

GOOSENECK HITCHES

OEM puck system kits, Double Lock EZr™ and more

272 - 291

5TH WHEEL HITCHES

OEM puck system options, A-, Q- and E-series hitches

292 - 313

WEIGHT DISTRIBUTION

TruTrack™ systems, WD hitch kits and sway control

314 - 325

TRAILER PARTS & ACCESSORIES

Jacks, couplers, safety chains, bearing protectors and more

326 - 343

CARGO MANAGEMENT

Cargo carriers, bike racks, cargo straps and tie-downs

344 - 361

MARKETING MATERIALS

Literature, signage and display stands

362 - 375

NUMERICAL TRAILER HITCHES

Numerical listing of front and rear mount trailer hitches

376 - 385

NUMERICAL PRODUCTS

Complete, numerically sorted product listing

386 - 392

NUMERICAL CUSTOM WIRING

Custom wiring listed numerically

393 - 400



UNDERSTANDING TOWING

CONFIDENCE TO BRING IT®

It is CURT's goal, first and foremost, to provide you with a complete line of quality products. We also strive to give you the resources needed to educate your customers, so they can Bring It® safely and confidently. Understanding Towing offers information on towing components, weight capacities, vehicle-trailer wiring and much more.

FOR MORE INFORMATION

TOWING 101
A beginner's guide to towing

TOWING GLOSSARY
Over 500 terms and definitions



Towing 101

This beginner's guide is perfect for educating new employees. It covers all key aspects of towing, from hitch selection to trailer hook-up.

Towing glossary

If you're looking for a term related to the towing industry, you'll likely find it here. This glossary contains over 500 definitions and images.

Product support team

If you have questions about CURT products or how to use them, our Product Support Team is standing by.

SECTION INDEX



8

The Basics of Towing a Trailer



9

Tow Electrical Subcategory Color Guide

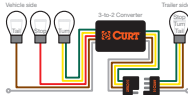

10

Electrical Wiring Systems



11

Electrical Connector Wiring Guide

THE BASICS OF TOWING A TRAILER

Gross trailer weight (GTW)

The gross trailer weight is the total weight of a trailer and its cargo. For example, GTW = boat + trailer + cooler + fishing gear. It is vitally important to know the GTW to ensure safe towing. It can be measured by putting the fully loaded trailer on a vehicle scale.

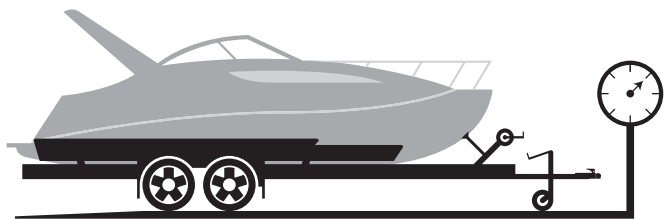

Weight carrying capacity (WC)

The weight carrying capacity is the total weight a trailer hitch is safely rated to tow without the assistance of a weight distribution system. When towing, always use the lowest weight capacity rating of the towing system.

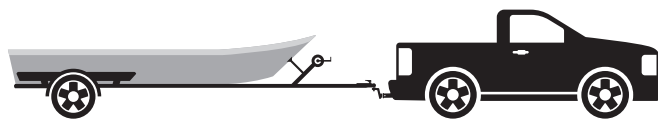

Tongue weight (TW)

Tongue weight is the downward force of the trailer at the coupling point. Proper TW should be about 10% to 15% of the GTW. To measure TW, use a commercial scale or a bathroom scale. In the method shown below, multiply the scale reading by three.

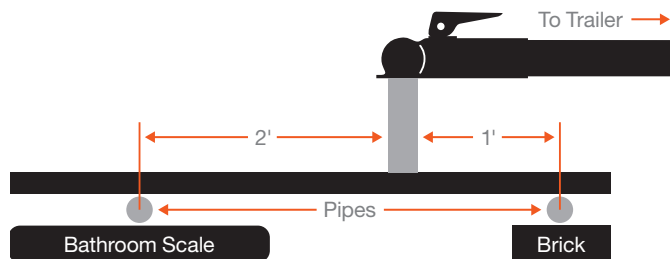

Weight distribution capacity (WD)

The weight distribution capacity is the maximum amount of weight a trailer hitch can safely tow with a weight distribution hitch installed. A weight distribution hitch distributes a portion of the TW across the vehicle and trailer. See page 317 for WD products.

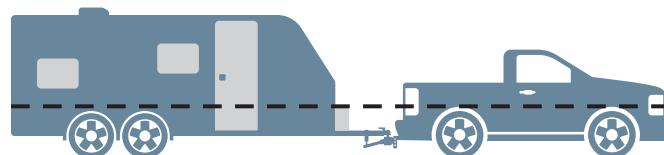

With weight distribution

Measuring ball mount drop & rise

When selecting a ball mount, it is important to determine drop / rise for leveling the trailer. Use the diagram below to find this value. B minus A equals C. If C is negative, this indicates the amount of drop needed. If positive, it indicates rise.

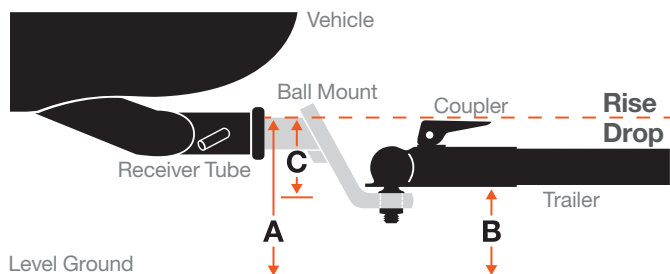

Level towing

Using a ball mount with the proper amount of drop or rise will allow for level towing across both trailer and vehicle. Without a level vehicle-trailer combination, the trailer can tend to wander and can even impair the driver's control over the vehicle.

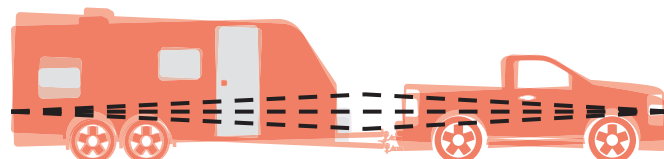

With too much rise or drop

TOWING ELECTRICAL SUBCATEGORY COLOR GUIDE

Towing Electrical

Page 235

CURT has identified seven subcategories within the towing electrical category to make it easier for retail customers to find the correct products. Each sub-category is given a unique color that we apply in our literature and retail packaging for easy visibility.

Brake controls

Page 237

Many trailers are equipped with electric trailer brakes, and to properly use them, a brake control is needed. A brake control regulates the trailer brakes from the dash of the vehicle and serves as an interface for the driver. There are two basic types: inertia-based and time-based. For more information, see page 237.

Custom wiring

Page 246

If your customer's vehicle is not equipped with a factory-installed connector, custom wiring is the ideal solution. Custom wiring (or a 'T-connector') plugs into the vehicle's electrical system, using the taillights or an OEM socket, and provides a trailer wiring connector. See the application guide, starting on page 32.

RV harnesses

Page 252

When dinghy towing a vehicle behind an RV, syncing the taillights is essential. This requires an electrical connection from the vehicle to the RV. CURT RV harnesses plug into the vehicle, using vehicle-specific plugs, and provide a standard 4-way flat to plug into the RV socket. See page 252 for a complete listing.

Electrical converters

Page 254

If a custom wiring harness is not available for a certain vehicle, an electrical converter may be required. A converter is designed to splice into a vehicle's wiring and convert the signals to be compatible with the trailer wiring, providing a standard 4-way flat socket. See page 254 for a complete listing of CURT converters.

Plugs & sockets

Page 261

A plug and socket are the basic components that allow a vehicle wiring system to connect to a trailer. Plugs and sockets can use anywhere from two to seven wires. When preparing to tow, the plug is inserted into the socket and supplies power to the trailer lights and other electronics. See page 261 for our plugs & sockets.

Electrical adapters

Page 256

An adapter allows a connection to be made between a mismatched trailer plug and vehicle socket. For example, a vehicle may be equipped with a 7-way, while the trailer may have a 4-way. An adapter can easily be installed to bridge the connection. For our full selection of adapters, see page 256.

Accessories & testers

Page 268

When installing CURT electrical products, certain electrical components may be required. For splicing, snap locks, wire nuts, terminals and butt connectors provide a reliable connection. When installing a trailer wiring connector or experiencing electrical problems, be sure to test the connection with an electrical tester.

ELECTRICAL WIRING SYSTEMS

Vehicles today use different wiring systems to carry out electrical functions, specifically for taillights, stop or brake lights and turn signals. As vehicles have advanced, these wiring systems have changed. To provide a proper wiring connection for towing a trailer, often times an electrical converter is needed. Below are the common wiring systems used in vehicles today, as well as the types of converters used.

Two-Wire System

The two-wire system is the simplest form of vehicle and trailer wiring and is still used by some vehicles today. This system sends the stop and turn signals along one wire, and the taillight signal along a second wire.



Three-Wire System

The three-wire system is the most common in the automotive industry. It sends the stop, taillight and turn signals along three separate wires. Vehicles with a this system usually require a converter.

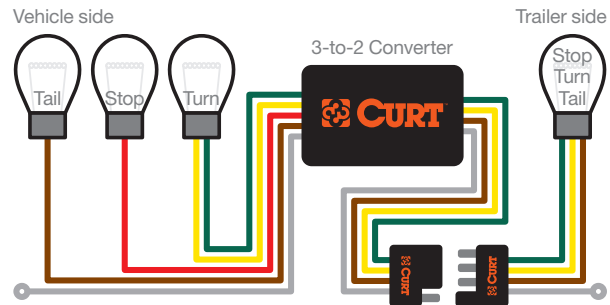

PWM Systems

More and more vehicles today use a PWM (pulse width modulation) system. Sometimes called a 'multiplex', this type of wiring is able to control multiple lighting functions through a single wire by varying the signal intensity. PWM systems can use incandescent or LED lights. There are generally two types: ST systems and STT systems. See the application guide on page 32 for a detailed listing of vehicles with ST and STT systems

ST system

The ST system (stop / tail) uses a single wire to control the stop and taillight signals. Separate wires are used to control the left and right turn signals.

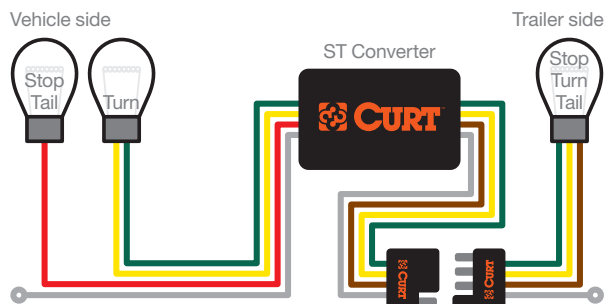

STT system

The STT system (stop / turn / tail) uses a single wire to control all three lighting functions: the stop or brake lights, turn signals and taillights.

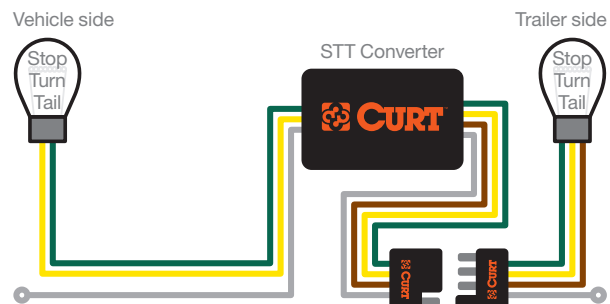

ELECTRICAL CONNECTOR WIRING GUIDE

There are several formats used for connecting trailer wiring, and each offers slightly different electrical functions. 'Socket' refers to the vehicle-side connection, and 'plug' is used to refer to the trailer side. While most plugs and sockets come with standard color-coded wires, the colors illustrated below may not reflect all vehicles and trailers.

7-way RV blade traditional configuration

Vehicle side Trailer side

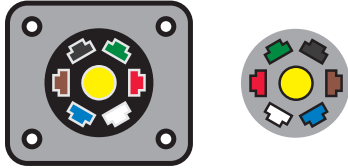

Function	Color
+12 volt	Black
Electric brakes	Blue
Reverse lights	Yellow
Left turn / brakes	Red
Right turn / brakes	Brown
Taillights	Green
Ground	White

7-way RV blade SAE J2863 configuration

Vehicle side Trailer side

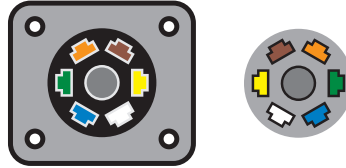

Function	Color
+12 volt	Orange
Electric brakes	Blue
Reverse lights	Grey
Left turn / brakes	Yellow
Right turn / brakes	Green
Taillights	Brown
Ground	White

The difference in configurations

Traditional configuration

The traditional 7-way RV blade format is typically used on 5th wheel trailers, travel trailers and campers.

SAE J2863 configuration

The SAE J2863 7-way RV blade format is typically used on gooseneck trailers, utility trailers, cargo trailers and equipment trailers.

7-way round

Vehicle side Trailer side

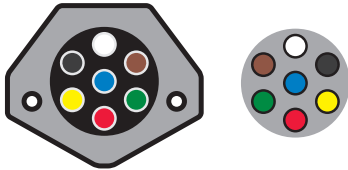

Function	Color
Auxiliary power	Red
Electric brakes	Blue
Reverse lights	Black
Left turn / brakes	Yellow
Right turn / brakes	Green
Taillights	Brown
Ground	White

6-way round

Vehicle side Trailer side

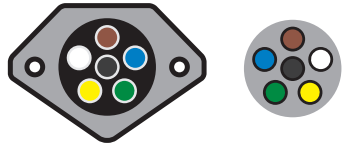

Function	Color
+12 volt	Black
Electric brakes	Blue
Left turn / brakes	Yellow
Right turn / brakes	Green
Taillights	Brown
Ground	White

6-way square

Vehicle side Trailer side

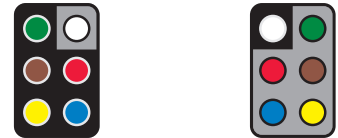

Function	Color
+12 volt	Red
Electric brakes	Blue
Left turn / brakes	Yellow
Right turn / brakes	Green
Taillights	Brown
Ground	White

5-way flat

Vehicle side Trailer side



Function	Color
Reverse lights	Blue
Left turn / brakes	Yellow
Right turn / brakes	Green
Taillights	Brown
Ground	White

4-way flat

Vehicle side Trailer side



Function	Color
Left turn / brakes	Yellow
Right turn / brakes	Green
Taillights	Brown
Ground	White

4-way round

Vehicle side Trailer side

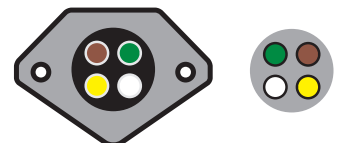

Function	Color
Left turn / brakes	Yellow
Right turn / brakes	Green
Taillights	Brown
Ground	White



TRAILER HITCHES

TESTED. PROVEN. SAFE.

CURT manufactures over 1,000 unique hitch models to provide a custom fit for nearly every vehicle on the road today. We engineer and rigorously test each one to SAE J684 protocols for safety. We protect each hitch, inside and out, with an industry-leading, rust-resistant finish, and we do all of this in the USA. CURT hitches are available in five classes with a range of weight capacities and receiver tube sizes. We also offer front mount, RV and multi-fit hitches for a complete range of towing options.

FEATURED PRODUCTS



Rear mount hitches

CURT is the industry leader in first-to-market hitch designs, and each one is engineered and tested to the highest safety standards.



Multi-fit hitches

Perfect for the retail setting, multi-fit hitches fit a wide range of applications and are available in several different weight capacities.



Front mount hitches

CURT front mount hitches are vehicle-specific and provide a useful receiver for a cargo carrier, snow plow or even for parking a trailer.

PRODUCT INDEX



14

Class 1 & 2
Trailer Hitches

Made in USA



15

Class 3 & 4
Trailer Hitches

Made in USA



15

Class 5
Trailer Hitches

Made in USA



17

Multi-Fit
Trailer Hitches



20

Weld-On
Trailer Hitches

Made in USA



21

Bumper
Hitches

Made in USA



21

Adjustable
RV Hitches

Made in USA



22

RV Towing
Products



23

Front Mount
Hitches

Made in USA



Trailer hitch weight ratings vary by part number and are limited to vehicle manufacturer's stated capacities.

For trailer hitch application guide go to page 32



CUSTOM-FIT TRAILER HITCHES

CURT custom hitches are broken out into five distinct classes, based on their receiver tube size and weight ratings. Despite these classes, weight ratings may vary by part number. Each hitch is made for vehicle-specific application and is always limited by the lowest rated towing component.

Product Details

- Made with a vehicle-specific design for a custom fit
- Tested for safety in accordance with SAE J684
- Precisely welded for superior strength and fit
- Co-cured in a rust-resistant liquid Bonderite® coating
- Strengthened with a cast, welded, seamless collar
- Open-back receiver for easy cleaning
- [Limited lifetime warranty](#)



Advantages of CURT trailer hitches



Proud to manufacture all of our custom hitches in the USA



Precision robotic welding for superior strength and fit



Liquid Bonderite® applied inside and out for max rust resistance



Industry-leading safety and performance testing



1 1/4
INCH

CLASS 1 & 2 TRAILER HITCHES

- 1 1/4" X 1 1/4" receiver tube opening
- Pin & clip included
- Protected by a durable high-gloss black powder coat finish
- Available with included ball mount (see page 30 for ordering options)

Class 1 weight ratings

GTW Up to 2,000 lbs.

TW Up to 200 lbs.

Class 2 weight ratings

GTW Up to 3,500 lbs.

TW Up to 350 lbs.





Trailer hitch weight ratings vary by part number and are limited to vehicle manufacturer's stated capacities.

For trailer hitch application guide go to page 32



2

INCH

CLASS 3 & 4 TRAILER HITCHES

- 2" x 2" receiver tube opening
- Protected by a durable high-gloss black powder coat finish

Class 3 weight ratings

GTW

Up to 8,000 lbs.

TW

Up to 800 lbs.

WD

Up to 12,000 lbs.

WD TW

Up to 1,200 lbs.

Class 4 weight ratings

GTW

Up to 10,000 lbs.

TW

Up to 1,000 lbs.

WD

Up to 12,000 lbs.

WD TW

Up to 1,200 lbs.



2

INCH

&

2 1/2

INCH

CLASS 5 TRAILER HITCHES

- 2" x 2" receiver tube opening on Xtra Duty and 2 1/2" x 2 1/2" on Commercial Duty
- Constructed with a large, powerful main body
- Protected by a highly durable carbide powder coat finish
- Features wide safety chain openings for heavy-duty hooks
- Includes strong, grade 8 installation hardware

Xtra Duty weight ratings

GTW

16,000 to 17,000 lbs.

TW

2,400 to 2,550 lbs.

WD

17,000 lbs.

WD TW

2,400 to 2,550 lbs.

Commercial Duty weight ratings

GTW

18,000 to 20,000 lbs.

TW

2,700 lbs.

WD

18,000 to 20,000 lbs.

WD TW

2,700 lbs.





Trailer hitch weight ratings vary by part number and are limited to vehicle manufacturer's stated capacities.



2
INCH

FRONT MOUNT HITCHES

For front mount hitch applications go to page 23

- 2" x 2" receiver tube opening
- Made with a vehicle-specific design for a custom fit
- Ideal for attaching a snow plow, cargo carrier or other accessory
- Allows for easy maneuvering of a trailer into a tight spot
- Tested for safety in accordance with SAE J684
- Durable black powder coat finish
- [Limited lifetime warranty](#)

Front mount weight ratings

GTW	Up to 5,000 lbs.	TW	Up to 500 lbs.
SLP	9,000 lbs. straight line pull	WD	Not available



2
INCH

ADJUSTABLE RV HITCHES

See page 21 for part number listing

- Built with a three-piece, adjustable design
- Designed for towing a trailer or small vehicle behind an RV
- Strengthened with a cast, welded, seamless collar
- Durable gloss black powder coat finish
- [Limited lifetime warranty](#)

RV hitch weight ratings

GTW	3,500 to 5,000 lbs.	TW	350 to 500 lbs.
WD	6,000 lbs.	WD TW	600 lbs.





1 1/4
INCH

12923 CLASS 2 MULTI-FIT HITCH

- Provides a 1 1/4" x 1 1/4" receiver tube opening on the rear of the vehicle
- 3,500 lbs. GTW and 350 lbs. TW
- Adjustable frame to fit a variety of vehicles
- Requires no drilling on most models
- Robotically welded for superior strength and fit
- Includes mounting hardware
- [Limited lifetime warranty](#)



12923

Make / Model	Style	Years
Chevrolet / GMC		
1500 / 2500 pickups,	Excl. step-sides and King cab	88 - 98
Astro	Extended chassis	85 - 05
Pickup	Full-size, excl. step-side and 1-ton	62 - 87
S-10 Blazer / S-15 Jimmy	--	83 - 94
S-10 pickup	8' bed, excl. Baja	83 - 03
S-15 / Sonoma Pickups	8' bed	88 - 04
Safari	Standard chassis	85 - 05
Suburban	--	92 - 05
Venture	--	97 - 04
Chrysler		
Town & Country	Excl. Stow-n-Go	88 - 07
Dodge		
Caravan	Excl. Stow-n-Go	88 - 07
Dakota	--	86 - 04
Pickups	Full-size, excl. 1-ton	67 - 02
Ramcharger	--	78 - 93

Make / Model	Style	Years
Ford		
Bronco	Full-size	78 - 97
Bronco II	--	85 - 90
Pickups	Excl. step-sides and 1-ton	74 - 97
Ranger	--	83 - 11
E-series vans	Excl. 1-ton	80 - 98
Jeep		
Wagoneer	--	87 - 90
Nissan		
Pickup	6' bed	87 - 94
Oldsmobile		
Bravada	--	91 - 94
Silhouette	--	97 - 05
Plymouth		
Trail Duster	--	74 - 91
Voyager	--	88 - 98
Pontiac		
6000	--	82 - 84
Transport / Montana	--	97 - 05
Toyota		
Pickup	6' bed, excl. T100	87 - 95

2

INCH

13903 CLASS 3 MULTI-FIT HITCH

- Provides a 2" x 2" receiver tube opening on the rear of the vehicle
- Provides a comprehensive retail option for pickups when combined with the 13902
- 8,000 lbs. GTW and 800 lbs. TW
12,000 lbs. WD and 1,200 lbs. WDTW
- Fits all F-150 models from 2006 through 2018
- Features two sets of mounting brackets (only one set will be used, based on the application)
- Robotically welded for superior strength and fit
- Includes mounting hardware
- [Limited lifetime warranty](#)



13903

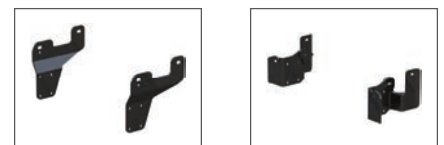

Application-specific side plates included

Make / Model	Years
Ford	
F-150	06 - 18

2

INCH

13902 CLASS 3 MULTI-FIT HITCH

- Provides a 2" x 2" receiver tube opening on the rear of the vehicle
- Provides a comprehensive retail option for pickups when combined with the 13903
- 8,000 lbs. GTW and 800 lbs. TW
12,000 lbs. WD and 1,200 lbs. WDTW
- Fits most full-size pickups from Ford, GM and Ram, including the latest models
- Robotically welded for superior strength and fit
- Includes mounting hardware
- [Limited lifetime warranty](#)



13902

Make / Model	Years
Chevrolet / GMC	
Silverado / Sierra 1500	99 - 18
Silverado / Sierra 2500	99 - 18
Silverado / Sierra 3500	01 - 18
Dodge	
Ram 1500	02 - 10
Ram 2500 / 3500	03 - 10

Make / Model	Years
Ford	
F-150	98 - 05
F-150 Heritage	04 - 04
F-250 / F-350 Super Duty	00 - 16
F-450 Super Duty	99 - 16
Ram	
1500 / 2500 / 3500	11 - 18

2

INCH

13901 CLASS 3 MULTI-FIT HITCH

- Provides a 2" x 2" receiver tube opening on the rear of the vehicle
- 5,000 lbs. GTW and 500 lbs. TW
7,500 lbs. WD and 750 lbs. WDTW
- Features multiple mounting holes to fit a variety of vehicles
- Requires no drilling on most models
- Robotically welded for superior strength and fit
- Includes mounting hardware
- [Limited lifetime warranty](#)



13901

Make / Model	Years
Chevrolet / GMC	
C1500 / K1500	99 - 99
C2500 / K3500	99 - 00
C3500 HD	01 - 02
Silverado / Sierra 1500	99 - 18
Silverado / Sierra 1500 Classic	07 - 07
Silverado / Sierra 1500 HD	05 - 06
Silverado / Sierra 1500 HD	01 - 03
Silverado / Sierra 1500 HD Classic	07 - 07
Silverado / Sierra 2500	99 - 04
Silverado / Sierra 2500 HD	01 - 14

Make / Model	Years
Chevrolet / GMC (continued)	
Silverado / Sierra 3500	01 - 06
Silverado / Sierra 2500 HD / 3500 HD Classic	07 - 07
Silverado / Sierra 3500 HD	07 - 14
Ford	
F-150	97 - 05
F-150 Heritage	04 - 04
F-250	97 - 99
F-250 / F-350 / F-450 Super Duty	99 - 16

2

INCH

13900 CLASS 3 MULTI-FIT HITCH

- Provides a 2" x 2" receiver tube opening on the rear of the vehicle
- 5,000 lbs. GTW and 500 lbs. TW
- Adjustable frame to fit a variety of vehicles
- Requires no drilling on most models
- Robotically welded for superior strength and fit
- Includes mounting hardware
- Limited lifetime warranty



13900

Make / Model	Style	Years
Chevrolet / GMC		
Astro	Extended chassis	85 - 05
Blazer	--	92 - 94
Blazer / Jimmy	Full-size	80 - 91
Pickup	Full-size, 8' bed, excl. step-side and 1-ton	87 - 98
Pickup	Full-size, excl. step-side and 1-ton	62 - 87
S-10	Short bed 4x4	98 - 04
S-10	Long bed	83 - 04
S-10	Crew cab	01 - 04
S-15	Short bed 4x4	98 - 00
S-15	Long bed	88 - 04
S-15	Crew cab	01 - 04
Safari	Spare tire may need relocating	85 - 05
Safari	Extended cab	85 - 99
Silverado / Sierra 1500	Classic body, 8' bed	99 - 07
Silverado / Sierra 2500HD / 3500	Full-size, 8' bed, excl. step-side	01 - 07
Silverado / Sierra 2500LD	8' bed	99 - 07
Suburban	--	92 - 06
Tahoe	--	95 - 06
G-Series	Full-size van	78 - 96
Express / Savana	Full-size van	96 - 17
Venture	--	97 - 04
Yukon / Yukon XL	--	92 - 06
Chrysler		
Town & Country	Excl. Stow-n-Go	88 - 07
Dodge		
Caravan	Excl. Stow-n-Go	84 - 07
Dakota	--	86 - 04
Dakota	Quad cab	00 - 01
Pickup	Full-size, excl. 1-ton	62 - 87
Ramcharger	--	78 - 93

Make / Model	Style	Years
Ford		
Aerostar	Extended cab	86 - 97
Bronco	Full-size	78 - 97
Bronco II	--	84 - 90
Escape	--	01 - 04
F-150	Step-sides with 6' bed, spare tire may need relocating	97 - 03
F-150	8' bed	99 - 03
F-250	6' bed	99 - 16
F-250 / F-350	8' bed, excl. 20" spare tire	99 - 16
Pickup	6' and 8' beds, excl. step-sides and 1-ton	74 - 97
Ranger	Excl. 98 - 06 flare side	83 - 06
Ranger	8' bed only, spare tire needs relocating	83 - 11
E-series vans	Excl. 1-ton	80 - 15
Windstar	--	99 - 03
Isuzu		
Hombre	Short bed 4x4	98 - 00
Jeep		
Cherokee XJ	--	84 - 01
Grand Cherokee	--	93 - 98
Liberty	--	02 - 06
Mazda		
Pickup	Excl. 98 - 06 flare side	90 - 06
Tribute	--	01 - 04
Nissan		
Pickup and Frontier	56" bed	87 - 04
Pickup and Frontier	75" bed	87 - 04
Plymouth		
Trail Duster	--	74 - 91
Voyager	--	01 - 03
Voyager	--	84 - 03
Toyota		
Pickup	8' bed, excl. T100	87 - 94
Tundra	--	00 - 06



2
INCH

CLASS 5 MULTI-FIT HITCHES

- Provides a 2" x 2" receiver tube opening with 5 1/2" drop (#15510) or 7 1/2" drop (#15511) on the rear of the vehicle
- 15,000 lbs. GTW and 1,500 lbs. TW
16,000 lbs. WD and 1,600 lbs. WDTW
- Multiple mounting holes to fit a variety of vehicles
- Robotically welded for superior strength and fit
- Includes strong, grade 8 mounting hardware
- Protected by a durable carbide powder coat finish
- [Limited lifetime warranty](#)



15510



15511

Make / Model	Style	Years	Part#
Chevrolet / GMC			
Cab & Chassis	34" frame (O.D.)	88 - 99	15510 or 15511
Pickup	Full-size, excluding short bed	62 - 87	15510 or 15511
Dodge			
Pickup	Full-size	72 - 93	15510 (5 1/2" drop)
Pickup	Full-size	72 - 96	15511 (7 1/2" drop)
Ford			
F-450 Cab & Chassis	2WD only	99 - 07	15510 or 15511
Pickup	Full-size, old body	67 - 99	15510 or 15511



2
INCH

UNIVERSAL WELD-ON TRAILER HITCHES

- Adjustable frame fits a variety of vehicles (side plates do not come pre-welded)
- Great for use with utility boxes
- Protected by a durable carbide powder coat finish
- [Limited lifetime warranty](#)



15901



15902



15903

Part#	GTW / TW	Drop	Maximum Width	Minimum Width
15901	15,000 / 1,500 lbs.	3 1/8"	43"	18"
15902	15,000 / 1,500 lbs.	11 1/2"	43"	18"
15903	15,000 / 1,500 lbs.	11 1/2"	60"	18"



Side plates come unattached to allow for easy adjustment



2
INCH

BUMPER HITCHES

- Bolts onto the bottom of the truck's step bumper (#19030 and #19031)
- Fits flush to factory bumpers on 1994 - 2002 Dodge trucks (#19050)
- Includes safety chain hookups and mounting hardware
- Limited lifetime warranty



19030



19031



19050

Pkg#	GTW / TW	Bolt Pattern	Years	Fits
19030	5,000 / 500 lbs.	8 1/2" width on center	--	Most factory steel bumpers
19031	5,000 / 500 lbs.	10 1/2" width on center	--	Westin and DMI bumpers
19050	4,000 / 400 lbs.	8" width on center	94 - 02	Dodge pickups with one-piece factory-formed steel step bumper



2
INCH

RV BUMPER HITCHES

- Includes safety chain hookups and mounting hardware
- Limited lifetime warranty

Pkg#	GTW / TW	Fits
19100	3,500 / 350 lbs.	4" x 4" channel bumpers
19101	3,500 / 350 lbs.	2" x 4" channel bumpers



19100



19101



2
INCH

ADJUSTABLE RV TRAILER HITCHES

- Three-piece, adjustable design fits multiple frame sizes
- Designed for towing a trailer or small vehicle behind an RV
- Limited lifetime warranty



13701



13702



13703

Part#	GTW / TW	WD / WDTW	Fits Frames	Drop
13701	5,000 / 500 lbs.	6,000 / 600 lbs.	Up to 51" wide	2"
13702	5,000 / 500 lbs.	6,000 / 600 lbs.	Up to 51" wide	--
13703	3,500 / 350 lbs.	--	Up to 72" wide	--



ADJUSTABLE TOW BAR

- Ideal for dingy towing a small vehicle behind an RV
- Adjusts in width from 26" to 41"
- Features a 2" heavy-duty coupler
- Lightweight, only weighs 31 lbs.
- Brackets bolt to the towed vehicle's bumper
- Universal bumper brackets and mounting hardware included



19745



19746



21500



19748



Tow bars adjust to fit different vehicles

Bulk#	Pkg#	Capacity	Ball Diameter	Finish	Dimensions	Description
--	19745	5,000 lbs.	2"	Gloss black	Adjusts from 26" to 41" in width	Adjustable tow bar
19746	--	--	--	Zinc-plated	1/2" diameter / 3" length	Replacement safety pin (new style)
21500	21501	--	--	Zinc-plated	5/8" diameter	Replacement pin & clip (old style)
19748	--	--	--	Gloss black	--	Bumper brackets (new style)



RV HARNESSES

- Connects a towed vehicle to an RV using a standard 4-way flat trailer plug
- Simple plug-and-play design eliminates the need for cutting or splicing
- Integrated block diodes isolate sensitive vehicle electronics from RV signals
- Uses towed vehicle's existing taillights, brake lights and turn signals
- Includes harness, 4-flat extension, mounting bracket and hardware
- See page 252 for application guide

NEW



58901

58902



TOWING LIGHTS

- Easily adds tow lights to a vehicle being dinghy towed
- Non-scratch magnetic base protects vehicle finish
- See page 268 for more information

Bulk#	Pkg#	Length	Plug	Description
53200	53204*	20'	4-way flat	Auxiliary towing lights



53204

53200

2 FRONT MOUNT ACCESSORIES

- Fits any 2" x 2" receiver tube opening
- Designed for use with front mount hitches
- Can also be used with rear mount hitches when not towing a trailer
- Also see cargo carriers on pages 346 and 347



Part#	Description
31006	Spare tire mount (mounting hardware not included)
31001	Step pad with anti-skid surface
31002	License plate holder
31007	Skid shield
31010	Winch mount
31005	Winch mount handles
31009	Winch mount with handles



Step pad provides easy under the hood access (31001)



Provides protection for the front end and hitch (31007)



Allows a winch to be easily attached to a receiver (31009)



24" height accepts multiple tire sizes (31006)



2 INCH

FRONT MOUNT HITCHES

- 2" x 2" receiver tube opening
- Up to 5,000 lbs. GTW and 500 lbs. TW / 9,000 lbs. straight line pull
- Provides a convenient mount for a snowplow or hitch accessory
- Allows for easy maneuvering of a trailer into a tight spot
- Tested for safety in accordance with SAE J684
- [Limited lifetime warranty](#)



Front Mount Hitches									
Make / Model	Style	Years	Part#	Foot Notes	GTW / TW (lbs.)	Price Code	Install Time	Main Body	
Buick									
Enclave	--	08 - 12	31045	D, ●	3500 / 350	35	30	Exposed	
Ranier	--	04 - 07	31055	D, ●	3500 / 350	71	45	Exposed	
Cadillac									
Escalade	Excluding Hybrid	07 - 14	31012	D	5000 / 500	37	45	Concealed	
	--	00 - 06	31302	D, ●	5000 / 500	55	60	Concealed	
Chevrolet									
Avalanche	Excluding Z71	07 - 13	31012	D	5000 / 500	37	45	Concealed	
	--	02 - 06	31302	D, ●	5000 / 500	55	60	Concealed	
Blazer	4WD, excluding ZR2	95 - 05	31021	●	3500 / 350	29	30	Exposed	
	Full-size SUV	92 - 94	31042	●	5000 / 500	41	30	Concealed	

D = Minor fascia trim
● = No drilling required

N = Continued while supplies last
Applications continued on the following page

Front Mount Hitches

Make / Model	Style	Years	Part#	Foot Notes	GTW / TW (lbs.)	Price Code	Install Time	Main Body
Chevrolet (continued)								
Colorado	--	15 - 17	31074	D, ●	5000 / 500	41	45	Concealed
	Z71 with front stabilizer bar	10 - 12	31030	D, ●	5000 / 500	29	20	Exposed
	Excl. Z71 with front stabilizer bar	10 - 12	31221	D, ●	5000 / 500	45	20	Concealed
	--	04 - 09	31221	●	5000 / 500	45	20	Concealed
Equinox	--	10 - 13	31032	D	3500 / 350	55	45	Concealed
Express	RV cutaway	03 - 03	31016	--	5000 / 500	25	35	Exposed
	--	96 - 02	31016	--	5000 / 500	25	35	Exposed
Pickup 1500 C / K Series	Old body	88 - 99	31042	●	5000 / 500	41	30	Concealed
Pickup 1500 Silverado	New body	14 - 18	31069	D	5000 / 500	37	45	Concealed
		14 - 18	31012	D	5000 / 500	37	45	Concealed
		07 - 13	31322	D, ●	5000 / 500	47	30	Concealed
	Classic body	99 - 07	31302	D, ●	5000 / 500	55	60	Concealed
Pickup 1500HD Silverado	Classic body	01 - 07	31108	D, ●	5000 / 500	47	30	Concealed
Pickup 2500 / 3500 C Series	Old body and 2WD	88 - 00	31043	--	5000 / 500	47	30	Exposed
Pickup 2500 / 3500 K Series	Old body and 4WD	88 - 00	31042	●	5000 / 500	41	30	Concealed
Silverado 2500 HD	High Country	15 - 15	31071	●	5000 / 500	37	25	Concealed
	LT	15 - 18	31071	●	5000 / 500	37	25	Concealed
	LTZ	15 - 18	31071	●	5000 / 500	37	25	Concealed
	WT	15 - 18	31071	●	5000 / 500	37	25	Concealed
	--	11 - 14	31023	D, ●	5000 / 500	17	30	Concealed
	New body	07 - 10	31109	●	5000 / 500	41	20	Concealed
	Classic body	00 - 07	31108	D, ●	5000 / 500	47	30	Concealed
Silverado 3500 HD	High Country	15 - 18	31071	●	5000 / 500	37	25	Concealed
	LT	15 - 18	31071	●	5000 / 500	37	25	Concealed
	LTZ	15 - 18	31071	●	5000 / 500	37	25	Concealed
	WT	15 - 18	31071	●	5000 / 500	37	25	Concealed
	--	11 - 14	31023	D, ●	5000 / 500	17	30	Concealed
	New body	07 - 10	31109	●	5000 / 500	41	20	Concealed
	Classic body	00 - 07	31108	D, ●	5000 / 500	47	30	Concealed
S-10 Pickup	4WD, excluding ZR2	94 - 04	31021	●	3500 / 350	29	30	Exposed
Suburban	--	15 - 17	31073	D	5000 / 500	37	45	Concealed
	Excluding Hybrid	07 - 14	31012	D	5000 / 500	37	45	Concealed
	--	00 - 06	31302	D, ●	5000 / 500	55	60	Concealed
	Old body and 2WD	92 - 99	31043	--	5000 / 500	47	30	Exposed
		92 - 99	31042	●	5000 / 500	41	30	Concealed
Suburban 2500 Series	--	01 - 06	31108	D, ●	5000 / 500	47	30	Concealed
Tahoe	LS	15 - 17	31073	D	5000 / 500	37	45	Concealed
	LT	15 - 17	31073	D	5000 / 500	37	45	Concealed
	Premier	17 - 17	31073	D	5000 / 500	37	45	Concealed
	LTZ	15 - 16	31073	D	5000 / 500	37	45	Concealed
	--	07 - 14	31012	D	5000 / 500	37	45	Concealed
		00 - 06	31302	D, ●	5000 / 500	55	60	Concealed
		Old body	95 - 99	31042	●	5000 / 500	41	30
Trailblazer	--	02 - 09	31055	D, ●	3500 / 350	71	45	Exposed
Traverse	--	09 - 12	31045	D, ●	3500 / 350	36	30	Exposed
Chrysler								
Aspen	--	06 - 09	31297	D, ●	5000 / 500	69	30	Exposed

D = Minor fascia trim
● = No drilling required

N = Continued while supplies last
Applications continued on the following page

Front Mount Hitches

Make / Model	Style	Years	Part#	Foot Notes	GTW / TW (lbs.)	Price Code	Install Time	Main Body
Dodge								
Dakota	--	08 - 10	31230	D, ●	3500 / 350	75	20	Exposed
		05 - 07	31228	D, ●	5000 / 500	91	30	Exposed
	4WD	00 - 04	31080	●	3500 / 350	63	40	Concealed
	--	98 - 99	31097	D, ●	3500 / 350	55	20	Exposed
Durango	Without OE tow hooks	14 - 17	31033	D	3000 / 300	57	35	Concealed
	Citadel, without OE tow hooks	11 - 13	31033	D	3000 / 300	57	35	Concealed
	Crew, without OE tow hooks	11 - 13	31033	D	3000 / 300	57	35	Concealed
	Express, without OE tow hooks	11 - 11	31033	D	3000 / 300	57	35	Concealed
	Special service, without OE tow hooks	12 - 13	31033	D	3000 / 300	57	35	Concealed
	SXT, without OE tow hooks	13 - 13	31033	D	3000 / 300	57	35	Concealed
	--	07 - 09	31297	D, ●	5000 / 500	69	30	Exposed
		04 - 06	31297	●	5000 / 500	69	30	Exposed
		00 - 03	31080	●	3500 / 350	63	40	Concealed
	98 - 99	31097	D, ●	3500 / 350	55	20	Exposed	
Ram 1500	Laramie, 4WD	09 - 10	31374	D	5000 / 500	41	30	Concealed
	SLT, 4WD	09 - 10	31374	D	5000 / 500	41	30	Concealed
	Sport, 4WD	09 - 10	31374	D	5000 / 500	41	30	Concealed
	ST, 4WD	09 - 10	31374	D	5000 / 500	41	30	Concealed
	TRX4, 4WD	09 - 10	31374	D	5000 / 500	41	30	Concealed
	Excluding Mega cab	06 - 08	31320	D	5000 / 500	47	30	Concealed
	Sport	06 - 07	31321	--	5000 / 500	47	30	Concealed
	--	02 - 05	31320	D, ●	5000 / 500	47	30	Concealed
		02 - 02	31604	--	5000 / 500	63	45	Concealed
		97 - 96	31604	--	5000 / 500	63	45	Concealed
	Laramie	97 - 01	31604	--	5000 / 500	63	45	Concealed
	SS/T 5.9L	97 - 98	31604	--	5000 / 500	63	45	Concealed
	ST	97 - 01	31604	--	5000 / 500	63	45	Concealed
	WS	97 - 01	31604	--	5000 / 500	63	45	Concealed
Ram 1500	Mega cab	06 - 08	31017	D	3500 / 350	53	30	Exposed
Ram 2500	4WD, incl. 2012 with OE winch	10 - 10	31015	D, ●	5000 / 500	49	30	Concealed
	Including Mega cab	03 - 09	31017	D	3500 / 350	53	30	Exposed
Ram 3500	--	10 - 10	31065	D	3500 / 350	45	45	Exposed
	Excluding Laramie	03 - 09	31017	D	3500 / 350	53	30	Exposed
Ram Pickup	--	94 - 02	31604	D, ●	5000 / 500	63	45	Exposed
Ford								
E-150	--	08 - 14	31053	D	5000 / 500	35	30	Exposed
	Including RV cutaway	91 - 07	33055	--	5000 / 500	35	20	Concealed
E-250	--	08 - 14	31053	D	5000 / 500	35	30	Exposed
	Including RV cutaway	91 - 07	33055	--	5000 / 500	35	20	Concealed
E-350 Super Duty	--	08 - 14	31053	D	5000 / 500	35	30	Exposed
	Including RV cutaway	91 - 07	33055	--	5000 / 500	35	20	Concealed
Edge	--	11 - 12	31050	D	3500 / 350	53	30	Concealed
Escape	--	11 - 12	31025	D	3500 / 350	41	40	Exposed
		05 - 10	31650	D	3500 / 350	55	90	Exposed
Excursion	Fog light removal required	00 - 05	31114	●	5000 / 500	75	45	Concealed

D = Minor fascia trim
● = No drilling required

N = Continued while supplies last
Applications continued on the following page

Front Mount Hitches

Make / Model	Style	Years	Part#	Foot Notes	GTW / TW (lbs.)	Price Code	Install Time	Main Body
Ford (continued)								
Expedition	--	09 - 17	31068	D, ●	5000 / 500	45	30	Exposed
	4WD	07 - 08	31368	D, ●	5000 / 500	45	30	Concealed
	4WD with OE tow hooks	03 - 08	31352	D, ●	5000 / 500	45	30	Concealed
		99 - 02	31038	●	5000 / 500	49	45	Concealed
		97 - 98	31049	●	5000 / 500	47	30	Concealed
Explorer	Excluding 2.0L EcoBoost	11 - 16	31052	D	3500 / 350	55	30	Exposed
	--	07 - 10	31545	●	5000 / 500	59	30	Concealed
	Excluding Sport	02 - 06	31540	D	5000 / 500	37	30	Concealed
	--	97 - 01	31051	--	3500 / 350	53	30	Concealed
Explorer Sport Trac	--	07 - 10	31545	●	5000 / 500	59	30	Concealed
		01 - 06	31029	--	5000 / 500	41	30	Exposed
		01 - 06	31407	●	3500 / 350	33	20	Exposed
F-150	King Ranch	15 - 18	31070	D, ●	5000 / 500	45	45	Concealed
	Lariat	15 - 18	31070	D, ●	5000 / 500	45	45	Concealed
	Limited	16 - 18	31070	D, ●	5000 / 500	45	45	Concealed
	Platinum	15 - 18	31070	D, ●	5000 / 500	45	45	Concealed
	SSV	16 - 18	31070	D, ●	5000 / 500	45	45	Concealed
	XL	15 - 18	31070	D, ●	5000 / 500	45	45	Concealed
	XLT	15 - 18	31070	D, ●	5000 / 500	45	45	Concealed
	--	09 - 14	31068	D, ●	5000 / 500	45	30	Exposed
	4WD EcoBoost only	11 - 13	31057	S, ●	5000 / 500	33	20	Exposed
	Excluding Heritage Edition	04 - 08	31352	D, ●	5000 / 500	45	30	Concealed
	4WD with OE tow hooks	99 - 03	31038	●	5000 / 500	49	45	Concealed
	--	97 - 98	31049	●	5000 / 500	47	30	Concealed
		92 - 96	31026	--	5000 / 500	53	30	Concealed
F-150 Heritage Edition	4WD	04 - 04	31038	●	5000 / 500	49	45	Concealed
F-250	New body	99 - 03	31038	●	5000 / 500	49	45	Concealed
		97 - 98	31049	●	5000 / 500	47	30	Concealed
	Old body, 4WD	97 - 97	31310	●	5000 / 500	41	30	Concealed
	Old body, 2WD	97 - 97	31311	●	5000 / 500	45	25	Exposed
	4WD	92 - 96	31310	●	5000 / 500	41	30	Concealed
	2WD	92 - 96	31311	●	5000 / 500	45	25	Exposed
F-250 Super Duty	King Ranch	17 - 18	31078	D, ●	5000 / 500	53	30	Concealed
	Lariat	17 - 18	31078	D, ●	5000 / 500	53	30	Concealed
	Platinum	17 - 18	31078	D, ●	5000 / 500	53	30	Concealed
	XL	17 - 18	31078	D, ●	5000 / 500	53	30	Concealed
	XLE	17 - 18	31078	D, ●	5000 / 500	53	30	Concealed
	4WD	11 - 16	31018	D, ●	5000 / 500	57	45	Concealed
	--	08 - 10	31008	D, ●	5000 / 500	37	20	Concealed
	Without blocker beam, fog light removal required	99 - 07	31114	--	5000 / 500	75	60	Concealed
	With blocker beam only	99 - 03	31014	--	5000 / 500	75	45	Concealed
F-350	F-350HD, 4WD	97 - 97	31310	●	5000 / 500	41	30	Concealed
	2WD Diesel	97 - 97	31311	●	5000 / 500	45	25	Exposed
	4WD	92 - 96	31310	●	5000 / 500	41	30	Concealed
	2WD	92 - 96	31311	●	5000 / 500	45	25	Exposed

D = Minor fascia trim
● = No drilling required

N = Continued while supplies last
Applications continued on the following page

Front Mount Hitches

Make / Model	Style	Years	Part#	Foot Notes	GTW / TW (lbs.)	Price Code	Install Time	Main Body	
Ford (continued)									
F-350 Super Duty	King Ranch	17 - 18	31078	D, ●	5000 / 500	53	30	Concealed	
	Lariat	17 - 18	31078	D, ●	5000 / 500	53	30	Concealed	
	Platinum	17 - 18	31078	D, ●	5000 / 500	53	30	Concealed	
	XL	17 - 18	31078	D, ●	5000 / 500	53	30	Concealed	
	XLE	17 - 18	31078	D, ●	5000 / 500	53	30	Concealed	
	4WD	11 - 16	31018	D, ●	5000 / 500	57	45	Concealed	
	--	08 - 10	31008	D, ●	5000 / 500	37	20	Concealed	
	Without blocker beam, fog light removal required	99 - 07	31114	--	5000 / 500	75	60	Concealed	
	With blocker beam only	99 - 03	31014	--	5000 / 500	75	45	Concealed	
F-350 Super Duty Cab & Chassis	With 34" Frame (O.D.)	08 - 10	31008	D, ●	5000 / 500	37	20	Concealed	
		99 - 07	31114	--	5000 / 500	75	60	Concealed	
F-450 Super Duty	--	17 - 17	31078	D, ●	5000 / 500	53	30	Concealed	
		08 - 10	31008	D, ●	5000 / 500	37	20	Concealed	
F-450 Super Duty Cab & Chassis	With 34" Frame (O.D.)	08 - 10	31008	D, ●	5000 / 500	37	20	Concealed	
		99 - 07	31114	--	5000 / 500	75	60	Concealed	
F-550 Super Duty Cab & Chassis	With 34" Frame (O.D.)	08 - 10	31008	D, ●	5000 / 500	37	20	Concealed	
		99 - 07	31114	--	5000 / 500	75	60	Concealed	
Ranger	Will not fit models with front cross member or Canadian built 2WD models	92 - 11	31063	D	3500 / 350	53	30	Concealed	
GMC									
Acadia	--	09 - 12	31045	D, ●	3500 / 350	35	30	Exposed	
Canyon	--	15 - 17	31074	D, ●	5000 / 500	41	45	Concealed	
		Z71 with front stabilizer bar	10 - 12	31030	D, ●	5000 / 500	29	20	Exposed
		Excl. Z71 with front stabilizer bar	10 - 12	31221	D, ●	5000 / 500	45	20	Concealed
		--	04 - 09	31221	●	5000 / 500	45	20	Concealed
Envoy	--	02 - 09	31055	D, ●	3500 / 350	71	45	Exposed	
Jimmy	4WD, excluding ZR2	94 - 01	31021	●	3500 / 350	29	30	Exposed	
Pickup 1500 C / K Series	Old body	88 - 99	31042	●	5000 / 500	41	30	Concealed	
Pickup 1500 Sierra	New body	14 - 18	31069	D	5000 / 500	37	45	Concealed	
		14 - 18	31012	D	5000 / 500	37	45	Concealed	
		07 - 13	31322	D, ●	5000 / 500	47	30	Concealed	
	Classic body	99 - 07	31302	D, ●	5000 / 500	55	60	Concealed	
Pickup 1500HD Sierra	Classic body	01 - 07	31108	D, ●	5000 / 500	47	30	Concealed	
Pickup 2500 / 3500 C Series	Old body and 2WD	88 - 00	31043	--	5000 / 500	47	30	Exposed	
Pickup 2500 / 3500 K Series	Old body and 4WD	88 - 00	31042	●	5000 / 500	41	30	Concealed	
Sierra 2500 HD	Base	15 - 18	31071	●	5000 / 500	37	25	Concealed	
	Denali	15 - 18	31071	●	5000 / 500	37	25	Concealed	
	SLE	15 - 18	31071	●	5000 / 500	37	25	Concealed	
	SLT	15 - 18	31071	●	5000 / 500	37	25	Concealed	
	--	11 - 14	31023	D, ●	5000 / 500	17	30	Concealed	
	New body	07 - 10	31109	●	5000 / 500	41	20	Concealed	
	Classic body	00 - 07	31108	D, ●	5000 / 500	47	30	Concealed	
	Sierra 3500 HD	Base, Denali, SLE	15 - 18	31071	●	5000 / 500	37	25	Concealed
		SLT	15 - 18	31071	●	5000 / 500	37	25	Concealed
11 - 14			31023	D, ●	5000 / 500	17	30	Concealed	
New body		07 - 10	31109	●	5000 / 500	41	20	Concealed	
Classic body		00 - 07	31108	D, ●	5000 / 500	47	30	Concealed	

D = Minor fascia trim
● = No drilling required

N = Continued while supplies last
Applications continued on the following page

Front Mount Hitches

Make / Model	Style	Years	Part#	Foot Notes	GTW / TW (lbs.)	Price Code	Install Time	Main Body
GMC (continued)								
Savana	RV cutaway	03 - 03	31016	--	5000 / 500	25	35	Exposed
	--	96 - 02	31016	--	5000 / 500	25	35	Exposed
Sonoma	4WD, excluding ZR2	94 - 04	31021	●	3500 / 350	29	30	Exposed
Terrain	--	10 - 13	31032	D	3500 / 350	55	45	Concealed
Yukon	--	15 - 17	31073	D	5000 / 500	37	45	Concealed
	Excluding Hybrid	07 - 14	31012	D	5000 / 500	37	45	Concealed
	New body	00 - 06	31302	D, ●	5000 / 500	55	60	Concealed
	Old body	92 - 00	31042	●	5000 / 500	41	30	Concealed
Yukon XL	--	15 - 17	31073	D	5000 / 500	37	45	Concealed
Yukon XL 1500	Excluding Hybrid	07 - 14	31012	D	5000 / 500	37	45	Concealed
	--	00 - 06	31302	D, ●	5000 / 500	55	60	Concealed
Yukon XL 2500	--	01 - 06	31108	D, ●	5000 / 500	47	30	Concealed
Honda								
Pilot	--	12 - 15	31064	--	3500 / 350	37	60	Exposed
		09 - 11	31024	D	3500 / 350	33	60	Exposed
		03 - 08	33328	D, ●	3500 / 350	55	35	Exposed
Ridgeline	--	17 - 17	31082	D	5000 / 500	55	30	Exposed
		05 - 14	33328	D, ●	3500 / 350	55	35	Exposed
Hummer								
H3	--	06 - 10	31270	●	3000 / 300	45	30	Exposed
Hyundai								
Santa Fe	--	10 - 11	31034	D, N	3500 / 350	47	45	Exposed
		07 - 09	31035	N	3500 / 350	49	45	Exposed
Jeep								
Cherokee	Excluding Grand Cherokee	84 - 01	31084	D	3000 / 300	25	30	Exposed
Comanche	--	86 - 92	31084	D	3000 / 300	25	30	Exposed
Commander	4WD	06 - 10	31056	--	3500 / 350	53	45	Exposed
Grand Cherokee	Laredo, Limited, Overland, without OE tow hooks	11 - 17	31033	D	3000 / 300	57	35	Concealed
	Summit, without OE tow hooks	14 - 17	31033	D	3000 / 300	57	35	Concealed
	75th Anniversary, without OE tow hooks	16 - 16	31033	D	3000 / 300	57	35	Concealed
	Overland Summit, without OE tow hooks	12 - 12	31033	D	3000 / 300	57	35	Concealed
	--	05 - 10	31047	D	3000 / 300	49	90	Exposed
	--	02 - 04	31048	--	3500 / 350	49	45	Concealed
Liberty	--	08 - 13	31020	D	3000 / 300	57	20	Concealed
	4WD	02 - 07	31022	--	3500 / 350	35	30	Exposed
Wagoneer	Excluding Grand Wagoneer	84 - 90	31084	D	3000 / 300	25	30	Exposed
Wrangler	With Hard Rock bumper only	07 - 17	31433	●	3500 / 525	47	20	Exposed
	Excl. Rock Hard / 75th Anni. bumpers	07 - 17	31432	D, ●	3500 / 350	47	45	Concealed
	--	97 - 06	31028	--	3500 / 350	45	30	Exposed
	--	87 - 06	31408	D, ●	3500 / 350	25	30	Exposed
Lincoln								
Mark LT	--	06 - 08	31352	D, ●	5000 / 500	45	30	Concealed
Navigator	--	09 - 17	31068	D, ●	5000 / 500	45	30	Exposed
	4WD	07 - 08	31368	D, ●	5000 / 500	45	30	Concealed
Mazda								
Tribute	--	05 - 11	31650	D	3500 / 350	55	90	Exposed

D = Minor fascia trim
● = No drilling required

N = Continued while supplies last
Applications continued on the following page

Front Mount Hitches

Make / Model	Style	Years	Part#	Foot Notes	GTW / TW (lbs.)	Price Code	Install Time	Main Body	
Mercury									
Mariner	--	11 - 11	31025	D	3500 / 350	41	40	Exposed	
		05 - 10	31650	D	3500 / 350	55	90	Exposed	
Mountaineer	--	07 - 10	31545	●	5000 / 500	59	30	Concealed	
Mitsubishi									
Raider	--	08 - 09	31230	D, ●	3500 / 350	75	20	Exposed	
Nissan									
Armada	--	17 - 17	31081	●	5000 / 500	55	30	Exposed	
Frontier	--	05 - 17	31241	●	3500 / 350	37	35	Exposed	
Pathfinder	--	05 - 12	31241	●	3500 / 350	37	35	Exposed	
Titan	4WD	09 - 15	31061	--	5000 / 500	69	45	Exposed	
	--	04 - 08	31199	--	5000 / 500	49	45	Exposed	
Titan XD	--	16 - 17	31077	●	5000 / 500	45	20	Exposed	
Xterra	--	05 - 15	31514	●	3500 / 350	59	35	Exposed	
Ram									
Ram 1500	Big Horn, 4WD	11 - 17	31374	D	5000 / 500	41	30	Concealed	
	Express, 4WD	12 - 17	31374	D	5000 / 500	41	30	Concealed	
	Laramie, 4WD	11 - 18	31374	D	5000 / 500	41	30	Concealed	
	Laramie Limited, 4WD	14 - 15	31374	D	5000 / 500	41	30	Concealed	
	Laramie Longhorn, 4WD	11 - 18	31374	D	5000 / 500	41	30	Concealed	
	Limited, 4WD	15 - 18	31374	D	5000 / 500	41	30	Concealed	
	Lone Star, 4WD	14 - 17	31374	D	5000 / 500	41	30	Concealed	
	Outdoorsman, 4WD	11 - 16	31374	D	5000 / 500	41	30	Concealed	
	Rebel, 4WD	15 - 18	31374	D	5000 / 500	41	30	Concealed	
	SLT, 4WD	11 - 18	31374	D	5000 / 500	41	30	Concealed	
	Special Service, 4WD	14 - 18	31374	D	5000 / 500	41	30	Concealed	
	Sport, 4WD	11 - 18	31374	D	5000 / 500	41	30	Concealed	
	ST, 4WD	--	18 - 18	31374	D	5000 / 500	41	30	Concealed
			11 - 12	31374	D	5000 / 500	41	30	Concealed
Tradesman, 4WD	11 - 18	31374	D	5000 / 500	41	30	Concealed		
Ram 2500	4WD, incl. 2012 with factory winch	11 - 16	31015	D, ●	5000 / 500	49	30	Concealed	
Ram 3500	--	17 - 17	31067	D, ●	5000 / 500	61	30	Both	
	Crew, extended and standard cabs	13 - 16	31067	D, ●	5000 / 500	61	30	Both	
	--	11 - 12	31065	D	3500 / 350	45	45	Exposed	
Suzuki									
Equator	4WD	09 - 12	31241	●	3500 / 350	37	35	Exposed	
Toyota									
4Runner	TRD Off-Road	17 - 17	31076	●	3500 / 350	63	20	Exposed	
	Limited	10 - 17	31054	●	3500 / 350	61	30	Exposed	
	SR5	--	10 - 13	31054	●	3500 / 350	61	30	Exposed
			14 - 17	31076	●	3500 / 350	63	20	Exposed
			14 - 16	31076	●	3500 / 350	63	20	Exposed
	Trail	--	07 - 09	31367	●	3500 / 350	61	30	Exposed
			10 - 13	31367	●	3500 / 350	61	30	Exposed
07 - 14			31367	●	3500 / 350	61	30	Exposed	
FJ Cruiser	--	07 - 14	31367	●	3500 / 350	61	30	Exposed	
Sequoia	--	08 - 17	31198	●	5000 / 500	17	20	Exposed	
		01 - 07	31180	--	5000 / 500	49	40	Exposed	
Tacoma	--	16 - 17	31075	D, ●	3500 / 350	47	30	Exposed	
		05 - 15	31313	●	3500 / 350	75	35	Exposed	
		01 - 04	31013	--	5000 / 500	45	45	Exposed	
Tundra	--	07 - 17	31198	●	5000 / 500	17	20	Exposed	
		00 - 06	31180	--	5000 / 500	49	40	Exposed	

D = Minor fascia trim
● = No drilling required

N = Continued while supplies last



APPLICATION GUIDE

TRAILER HITCHES & CUSTOM WIRING

With over 1,000 different custom-fit hitch designs and over 400 custom wiring products, CURT offers applications for almost every vehicle available. The Application Guide makes it easy to locate the correct part for your customer's vehicle, simply using the make, model, style and year. It is ordered alphabetically by make and model. It provides all applicable part numbers for any given vehicle, including the custom hitch and wiring options. It also offers pertinent information about each product and its installation requirements.

With CURT's first-to-market focus, our product line is ever-expanding. To keep you up-to-date on the latest hitch and wiring applications, we offer an online version of our Application Guide that is updated on a regular basis. You and your customers can also use our vehicle lookup tool found at the top of each page of our website.

CLASS 1 & 2 TRAILER HITCH ORDERING OPTIONS

Standard

Hitch only - no ball mount



Option one

Hitch with 1 7/8" ball Euro Mount®



Option two

Hitch with 2" ball Euro Mount®



Option three

Hitch with old-style ball mount



Ordering Option	Add-On Number	Example of Order Number	Description of Contents
Standard	None	12226	12226 trailer hitch, no ball mount
Option one	1	122261	12226 trailer hitch, Euro Mount® with 1 7/8" trailer ball
Option two	2	122262	12226 trailer hitch, Euro Mount® with 2" trailer ball
Option three	3	122263	12226 trailer hitch, old-style ball mount

All of the options listed above include a pin & clip

ADVANTAGES OF THE EURO MOUNT®

If your customer is looking for a simple, maintenance-free 1 1/4" ball mount option, the Euro Mount® is the perfect choice. With the Euro Mount®, there are fewer installation requirements, and it is easy to choose the right fit. Take a look at the full line on page 198 to find the Euro Mount® that works best for your customer's towing needs.



No tools or torque specs required



Permanently attached trailer ball



Engineered with a sleek, modern look

Each Euro Mount® was designed to replace a common, old-style ball mount, making trailer ball installation unnecessary

The comparisons below illustrate which Euro Mount® replaces a common, old-style ball mount



45561 Euro Mount® vs 45520 old-style



45591 Euro Mount® vs 45522 old-style



45571 Euro Mount® vs 45521 old-style



45581 Euro Mount® vs 45521 old-style



45551 Euro Mount® vs 45518 old-style

HOW TO CONFIRM VEHICLE MODEL YEAR

Each VIN (vehicle identification number) is unique and has become standard in all vehicles manufactured since 1981. Of this 17-digit number, the 10th digit represents the model year. Use the table below to find the year that corresponds with each letter or number. **Note:** A VIN will never contain the letters I (i), O (o), Q (q), U (u) or Z (z).

Example VIN tag

DATE: 06/18	GVWR 7200LB / 3266KG
FRONT GAWR: 3750LB	REAR GAWR: 3850LB
1701 KB	WITH 1745KG
P275 / 65R18	TIRES WITH P275/65R18
18X7.5J	RIMS WITH 18X7.5J
AT 240 KPO/35PSI COLD	AT 240 KPO/35PSI COLD

THIS VEHICLE CONFORMS TO ALL APPLICABLE FEDERAL MOTOR VEHICLE SAFETY STANDARDS IN EFFECT ON THE DATE OF MANUFACTURE SHOWN ABOVE.

VIN: XXXXXXXXXJXXXXXXX
TYPE: TRUCK

J indicates a 2018 model year

VIN-to-year chart

Code	Year	Code	Year	Code	Year	Code	Year
A	1980	L	1990	Y	2000	A	2010
B	1981	M	1991	1	2001	B	2011
C	1982	N	1992	2	2002	C	2012
D	1983	P	1993	3	2003	D	2013
E	1984	R	1994	4	2004	E	2014
F	1985	S	1995	5	2005	F	2015
G	1986	T	1996	6	2006	G	2016
H	1987	V	1997	7	2007	H	2017
J	1988	W	1998	8	2008	J	2018
K	1989	X	1999	9	2009	K	2019



FEATURED PRODUCTS



3" ball mounts

These heavy-duty ball mounts are the perfect complement to trailer hitches with a 3" x 3" receiver tube opening.



3" reducer sleeve set

To allow 3" receivers to work with a variety of CURT ball mounts and other products, this set reduces from 3" to 2 1/2" or 2".



Adjustable channel mounts

Our patented channel mounts are highly adjustable and have a built-in anti-rattle. We carry 2" and 2 1/2" shank options.

PRODUCT INDEX



197
Ball
Mounts



203
Forged Ball
Mounts



204
Adjustable
Channel Mounts



210
Tow Hook
Mounts



212
Extenders
& Adapters



214
Pintles &
Lunette Eyes



218
Trailer
Balls



222
Hitch & Coupler
Lock Sets



227
Hitch
Pins & Clips



229
Fab
Components



230
Trailer Hitch
Accessories



232
RV Towing
Products

ACCESSORIES OVERVIEW

Ball Mounts

The majority of our ball mounts are made in the USA. We use CNC-forming and robotic welding for the utmost accuracy, and each is protected with a durable powder coat finish.

- 1 1/4", 2", 2 1/2" and 3" shank options
- GTW capacities ranging from 2,000 up to 20,000 lbs.
- [See page 197 for ball mounts](#)



Pintles & Lunette Eyes

Pintle hitches are widely used in agriculture, construction and the military. We offer standard pintle hooks and mounts, ball and pintle combinations and receiver-mount pintles.

- GTW capacities up to 60,000 lbs.
- 2" and 2 1/2" shank options available
- [See page 214 for pintle products](#)

Towing Security

CURT carries several styles of hitch locks and coupler locks to fit any receiver tube or coupler latch. We also offer a number of specialty locks, including 5th wheel hitch locks.

- Pins available to fit 1 1/4", 2", 2 1/2" and 3" receivers
- Convenient 1/4-turn lock activation on most models
- [See page 222 for towing security products](#)

Hitch Accessories

Some of the other trailer hitch accessories we offer include front mount accessories, hitch tube covers, fish wire and a finishing pack for trailer hitch and electrical installations.

- Front accessories include winch and skid plates
- Hitch tube covers for 1 1/4", 2", 2 1/2" and 3"
- [See page 230 for hitch accessories](#)

Trailer Balls

We offer trailer balls for any and every job. They are available in three different finish options, including stainless steel, and all are tested to meet U.S. VESC specifications for safety.

- Standard diameters of 1 7/8", 2" 2 5/16" and 3"
- GTW capacities ranging from 2,000 up to 30,000 lbs.
- [See page 218 for trailer balls](#)

Fab Components

CURT fabrication components are the perfect building blocks for a variety of DIY welding project. Most components are made in the USA and come with a raw finish for ready welding.

- Hitch bars ranging from 8" to 24" long
- Receiver tubing available in 1 1/4", 2" and 2 1/2"
- [See page 229 for fabrication components](#)

RV Towing

CURT has what your customers need to outfit their RV for the ultimate road trip. Our hitches, tow bars and electrical products make it easy to tow a trailer or dinghy tow a vehicle.

- Adjustable RV and bumper hitches with 2" receiver
- RV harnesses offer a custom fit for dinghy towing
- [See page 232 for RV towing products](#)

BALL MOUNTS

Measuring a ball mount

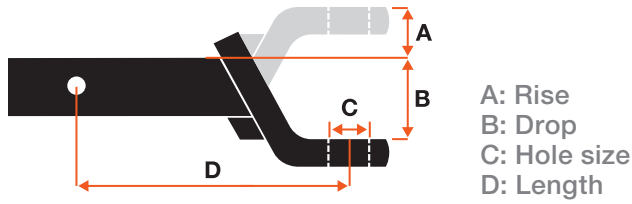

1 1/4 INCH & 2 INCH TOWING STARTER KITS

- Includes all the accessories needed to complement a trailer hitch in one kit
- Reusable case is able to be shelved or hung on pegs (#45534, #45554)



Part#	Shank Size	GTW / TW	Ball Diameter	Drop	Rise	Length	Included Parts
45141	2"	7,500 / 750 lbs.	2"	2"	--	7 1/2"	45134 Fusion ball mount, 23021 hitch lock
45142	2"	7,500 / 750 lbs.	2"	4"	--	8 1/8"	45154 Fusion ball mount, 23021 hitch lock
45148	1 1/4"	3,500 / 350 lbs.	2"	3 1/4"	2 5/8"	7 1/4"	45521 ball mount, 40003 trailer ball, 21403 pin & clip
45147	1 1/4"	3,500 / 350 lbs.	2"	1 1/4"	3/4"	9 3/4"	45519 ball mount, 40003 trailer ball, 21403 pin & clip
45534*	2"	7,500 / 750 lbs.	2"	2"	3/4"	8 1/4"	45030 ball mount, 40037 trailer ball, 23515 hitch lock, 22272 hitch tube cover, 21500 pin & clip, case
45554*	2"	7,500 / 750 lbs.	2"	4"	2"	8 1/4"	45050 ball mount, 40037 trailer ball, 23515 hitch lock, 22272 hitch tube cover, 21500 pin & clip, case

*Sturdy, reusable case included

ADVANTAGES OF THE EURO MOUNT®

If your customer is looking for a simple, maintenance-free 1 1/4" ball mount option, the Euro Mount® is the perfect choice. With the Euro Mount®, there are fewer installation requirements, and it is easy to choose the right fit. Take a look below to find the Euro Mount® that works best for your customer's towing needs.



No tools or torque specs required



Permanently attached trailer ball



Engineered with a sleek, modern look

Each Euro Mount® was designed to replace a common, old-style ball mount, making trailer ball installation unnecessary

The comparisons below illustrate which Euro Mount® replaces a common, old-style ball mount



45561 Euro Mount® vs 45520 old-style



45591 Euro Mount® vs 45522 old-style



45571 Euro Mount® vs 45521 old-style



45581 Euro Mount® vs 45521 old-style



45551 Euro Mount® vs 45518 old-style

Measuring a Euro Mount®

Required Ball Height = A - B

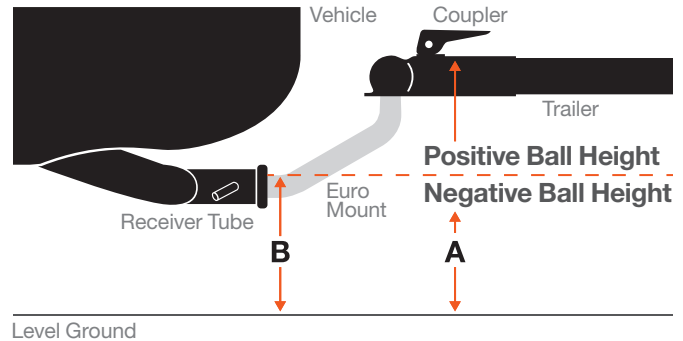

1 1/4 INCH EURO MOUNT® BALL MOUNTS

- Fits any 1 1/4" x 1 1/4" receiver tube opening
- Installs easily with no tools or torque specifications required
- Permanently attached trailer ball cannot be loosened or stolen
- Protected by a highly durable carbide powder coat finish
- Patents: D610,051 S; D610,492 S; D610,493 S; D610,494 S; D610,954 S

Part#	GTW / TW	Ball Diameter	Ball Height	Length
45551	3,500 / 350 lbs.	1 7/8"	2 3/4"	10"
45571	3,500 / 350 lbs.	1 7/8"	4 5/8"	7 1/4"
45561	3,500 / 350 lbs.	1 7/8"	5 1/8"	9 3/4"
45591	3,500 / 350 lbs.	1 7/8"	5 1/8"	11 1/4"
45581	3,500 / 350 lbs.	1 7/8"	- 3/4"	8 3/4"
45552	3,500 / 350 lbs.	2"	2 3/4"	10"
45572	3,500 / 350 lbs.	2"	4 5/8"	7 1/4"
45562	3,500 / 350 lbs.	2"	5 1/8"	9 3/4"
45592	3,500 / 350 lbs.	2"	5 1/8"	11 1/4"
45582	3,500 / 350 lbs.	2"	- 3/4"	8 3/4"



45551 (1 7/8" ball)
45552 (2" ball)



45571 (1 7/8" ball)
45572 (2" ball)



45561 (1 7/8" ball)
45562 (2" ball)



45591 (1 7/8" ball)
45592 (2" ball)



45581 (1 7/8" ball)
45582 (2" ball)

1 1/4
INCH

CLASS 1 & 2 BALL MOUNTS

- Fits any 1 1/4" x 1 1/4" receiver tube opening
- Multiple drop and rise options to accommodate various vehicle-trailer combinations
- Hollow shanks can be used with an anti-rattle kit



Part#	GTW / TW	Drop	Rise	Length	Hole Size	Shank Type	Finish
Class 1 Ball Mounts							
45018	2,000 / 200 lbs.	1 1/4"	5/8"	6 3/4"	3/4"	Hollow	Gloss black
45019	2,000 / 200 lbs.	1 1/4"	5/8"	9 3/4"	3/4"	Hollow	Gloss black
45027	2,000 / 200 lbs.	3 1/4"	2 5/8"	6 1/4"	3/4"	Hollow	Gloss black
45022	2,000 / 200 lbs.	3 1/4"	2 5/8"	7 1/4"	3/4"	Hollow	Gloss black
45026	2,000 / 200 lbs.	3 1/4"	2 5/8"	9 3/8"	3/4"	Hollow	Gloss black
45028	2,000 / 200 lbs.	6"	4 5/8"	5 9/16"	3/4"	Solid	Gloss black
45021	2,000 / 200 lbs.	--	3"	9 1/2"	3/4"	Solid	Gloss black
45023	2,000 / 200 lbs.	--	3 3/4"	11 1/2"	3/4"	Solid	Gloss black
45024	2,000 / 200 lbs.	--	5"	9 9/16"	3/4"	Solid	Gloss black
45025	2,000 / 200 lbs.	--	5"	11 9/16"	3/4"	Solid	Gloss black
Class 2 Ball Mounts							
45503	3,500 / 350 lbs.	1"	3/8"	7 13/16"	3/4"	Solid	Gloss black
45518	3,500 / 350 lbs.	1 1/4"	3/4"	6 3/4"	3/4"	Solid	Gloss black
45519	3,500 / 350 lbs.	1 1/4"	3/4"	9 3/4"	3/4"	Solid	Gloss black
45017	3,500 / 350 lbs.	3 1/4"	2 5/8"	6 1/4"	3/4"	Solid	Gloss black
45521	3,500 / 350 lbs.	3 1/4"	2 5/8"	7 1/4"	3/4"	Solid	Gloss black
45016	3,500 / 350 lbs.	3 1/4"	2 5/8"	9 3/8"	3/4"	Solid	Gloss black
45520	3,500 / 350 lbs.	--	3 1/8"	9 3/4"	3/4"	Solid	Gloss black
45510	3,500 / 350 lbs.	--	3 1/8"	10 5/16"	3/4"	Solid	Gloss black
45522	3,500 / 350 lbs.	--	3 1/8"	11 1/4"	3/4"	Solid	Gloss black
45000	3,500 / 350 lbs.	--	3 7/8"	13 1/2"	3/4"	Solid	Gloss black
45014	3,500 / 350 lbs.	--	5"	9 5/8"	3/4"	Solid	Gloss black
45015	3,500 / 350 lbs.	--	5"	11 5/8"	3/4"	Solid	Gloss black

2

INCH

CLASS 3 BALL MOUNTS

- Fits any 2" x 2" receiver tube opening
- Multiple drop and rise options to accommodate various vehicle-trailer combinations
- Increased drop on select models allows for level towing with lifted vehicles
- Hollow shanks can be used with an anti-rattle kit
- White box kits include a pin & clip



45080



45100



45112



45010



45020



45250



45030



45290



45033



45040



45260



45050



45296



45060



45270



45012



45011



45032



45031



45052



45051

Black Bulk#	Chrome Bulk#	Retail Pkg#	White Box Kit#	With Pin & Clip Poly Bag#	GTW / TW	Drop	Rise	Length	Hole Size
45030	45290	45031	45032	45033	7,500 / 750 lbs.	2"	3/4"	7 1/2"	1"
45010	--	45011	45012	--	7,500 / 750 lbs.	2"	3/4"	8 1/4"	1"
45040	--	--	--	--	7,500 / 750 lbs.	2"	3/4"	10 1/4"	1"
45020	--	--	--	--	7,500 / 750 lbs.	2"	3/4"	10 1/4"	1"
45260	--	--	--	--	7,500 / 750 lbs.	2"	3/4"	12 1/4"	1"
45250	--	--	--	--	7,500 / 750 lbs.	2"	3/4"	12 1/4"	1"
45050	45296	45051	45052	--	7,500 / 750 lbs.	4"	2"	8 1/4"	1"
45060	--	--	--	--	7,500 / 750 lbs.	4"	2"	10 1/4"	1"
45270	--	--	--	--	7,500 / 750 lbs.	4"	2"	13"	1"
45070	45297	--	--	--	7,500 / 750 lbs. drop 6,000 / 600 lbs. rise	6"	4"	9 1/4"	1"
45080	--	--	--	--	7,500 / 750 lbs. drop 6,000 / 600 lbs. rise	6"	4"	12 1/4"	1"
45280	--	--	--	--	7,500 / 750 lbs. drop 6,000 / 600 lbs. rise	6"	4"	14 1/4"	1"
45090	--	--	--	--	5,000 / 500 lbs. drop 3,500 / 350 lbs. rise	8"	6"	11 1/2"	1"
45100	--	--	--	--	5,000 / 500 lbs. drop 3,500 / 350 lbs. rise	8"	6"	13"	1"
45110	--	--	--	--	5,000 / 500 lbs. drop 3,500 / 350 lbs. rise	10"	8"	13"	1"
45112	--	--	--	--	5,000 / 500 lbs. drop 3,500 / 350 lbs. rise	10"	8"	14"	1"

2 INCH RIGHT-ANGLE BALL MOUNTS

- Fits any 2" x 2" receiver tube opening
- Angled shank allows for easier insertion into the receiver tube
- Hollow shanks can be used with an anti-rattle kit



Part#	GTW / TW	Drop	Rise	Length	Hole Size	Finish
45047	7,500 / 750 lbs.	2"	3/4"	10 1/4"	1"	Gloss black
45067	7,500 / 750 lbs.	4"	2"	10 1/4"	1"	Gloss black
45087	7,500 / 750 lbs. drop	6"	4"	12 1/4"	1"	Gloss black
	6,000 / 600 lbs. rise					



2 INCH DUAL-LENGTH BALL MOUNTS

- Fits any 2" x 2" receiver tube opening
- Two hitch pin holes for varying length
- Hollow shanks can be used with an anti-rattle kit



Part#	GTW / TW	Drop	Rise	Length	Hole Size	Finish
45220	7,500 / 750 lbs.	2"	3/4"	7 1/2" or 10 1/2"	1"	Gloss black
45230	7,500 / 750 lbs.	4"	2"	8 1/8" or 11 1/8"	1"	Gloss black
45240	7,500 / 750 lbs. drop	6"	4"	9 1/4" or 12 1/4"	1"	Gloss black
	6,000 / 600 lbs. rise					



2

INCH

CLASS 4 BALL MOUNTS

- Fits any 2" x 2" receiver tube opening
- Increased drop allows for level towing with lifted vehicles
- Hollow shanks can be used with an anti-rattle kit



Part#	GTW / TW	Drop	Rise	Length	Hole Size	Shank Type	Finish
45310	10,000 / 1,000 lbs.	2"	1"	9 3/8"	1 1/4"	Hollow	Gloss black
45311	10,000 / 1,000 lbs.	4"	2 3/4"	9 3/8"	1 1/4"	Hollow	Gloss black
45336	10,000 / 1,000 lbs.	6"	4 3/4"	9 3/8"	1 1/4"	Hollow	Gloss black
45338	10,000 / 1,000 lbs.	8"	6 3/4"	9 3/8"	1 1/4"	Hollow	Gloss black
45312	12,000 / 1,200 lbs.	2"	1"	9 3/8"	1 1/4"	Solid	Gloss black
45313	12,000 / 1,200 lbs.	4"	3"	9 3/8"	1 1/4"	Solid	Gloss black
45446	12,000 / 1,200 lbs.	6"	5"	9 3/8"	1 1/4"	Solid	Gloss black
45448	12,000 / 1,200 lbs.	8"	7"	9 3/8"	1 1/4"	Solid	Gloss black

2½

INCH

COMMERCIAL DUTY BALL MOUNTS

- Fits any 2 1/2" x 2 1/2" receiver tube opening
- Ideal for CURT class 5 Commercial Duty trailer hitches (page 15)
- Shank constructed from solid steel for optimum strength



Part#	GTW / TW	Drop	Rise	Length	Hole Size	Finish
45425	15,000 / 1,500 lbs.	3"	1 1/2"	9 1/2"	1 1/4"	Carbide
45426	15,000 / 1,500 lbs.	5"	3 1/2"	10"	1 1/4"	Carbide
45427	15,000 / 1,500 lbs.	8"	6 1/4"	10 1/2"	1 1/4"	Carbide

2 INCH & 2½ INCH & 3 INCH FORGED BALL MOUNTS

- Fits 2", 2 1/2" or 3" receiver tube openings
- Ideal for CURT class 5 Xtra Duty and Commercial Duty trailer hitches (page 15)
- Constructed from solid, forged steel for superior strength



Part#	Shank Size	GTW / TW	Drop	Rise	Length	Hole Size	Finish
2" x 2" Xtra Duty Forged Ball Mounts							
45340	2" x 2"	17,000 / 2,550 lbs.	2"	1"	8 1/2"	1 1/4"	Carbide
45341	2" x 2"	17,000 / 2,550 lbs.	4"	3"	8 1/2"	1 1/4"	Carbide
45342	2" x 2"	17,000 / 2,550 lbs.	6"	5"	9 1/2"	1 1/4"	Carbide
2 1/2" x 2 1/2" Commercial Duty Forged Ball Mounts							
45456	2 1/2" x 2 1/2"	20,000 / 2,700 lbs.	2"	1/2"	8 1/2"	1 1/4"	Carbide
45458	2 1/2" x 2 1/2"	20,000 / 2,700 lbs.	4"	2 1/2"	8 1/2"	1 1/4"	Carbide
3" x 3" Industrial Duty Forged Ball Mounts							
45430	NEW 3" x 3"	21,000 / 2,800 lbs.	4"	2"	9"	1 1/4"	Carbide
45431	NEW 3" x 3"	21,000 / 2,800 lbs.	6"	4"	10"	1 1/4"	Carbide
45432	NEW 3" x 3"	21,000 / 2,800 lbs.	8"	6"	10 1/2"	1 1/4"	Carbide



2 INCH & **2 1/2** INCH **ADJUSTABLE CHANNEL MOUNTS**

⚠️ Weight capacities limited to the lowest rated towing component

- Adjustable channel mount allows for precise trailer leveling
- Shank can be flipped to maximize rise or drop
- Built-in anti-rattle helps promote quiet towing
- Channels measure 3" wide (I.D.) with holes spaced 1" on center
- Ball mount and dual-ball mounts include pins & clips
- Pintle mounts include safety pin (#25012)
- Protected by a durable carbide powder coat finish
- See page 205 for replacement parts
- Patent# US8,033,563 (#45900, #45901, #45902)
- **Five-year limited warranty (#45900, #45901, #45902)**



Built-in anti-rattle prevents shaking (45901 and 45902)



Built-in anti-rattle prevents shaking (45900)

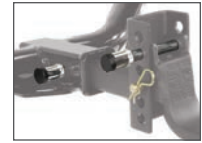

Locks secure mount (sold separately)



45901



45900



45902



45919
45920
45922

Pkg#	Shank Size	Ball Mount GTW / TW	2" Ball GTW / TW	2 5/16" Ball GTW / TW	Max Drop	Max Rise	Length	Hole Size
45901	2"	6,000 / 600 lbs.	--	--	6 3/4"	5 1/4"	11" and 12"	1"
45900	2"	--	10,000 / 1,000 lbs.	14,000 / 1,400 lbs.	6"	5 1/4"	11" and 12"	--
45902	2 1/2"	--	10,000 / 1,000 lbs.	20,000 / 2,000 lbs.	6"	5 1/4"	11" and 12"	--
45919*	--	--	10,000 lbs.	--	--	--	--	1 1/4"
45920*	--	--	--	13,000 lbs.	--	--	--	1 1/4"
45922*	--	--	--	20,000 lbs.	--	--	--	1 1/4"

* Pins not included (see page 205 for pin options)



2 INCH & **2 1/2** INCH

ADJUSTABLE CHANNEL MOUNT REPLACEMENT PARTS

- Shanks can be flipped to maximize rise or drop
- Built-in anti-rattle helps promote quiet towing
- Shank channels measure 3" wide (I.D.) with holes spaced 1" on center
- Shanks are protected by a highly durable carbide powder coat finish
- #23556 replaces adjustable channel mount pins for increased security
- #45916 replaces the anti-rattle kit for the adjustable channel mount #45901 or #45902
- #45925 replaces the pins for the adjustable channel mounts



Built-in anti-rattle prevents shaking



Pins & clips secure mount into place



Locks secure the mount from theft



Pkg#	Description	GTW / TW	Shank Size	Length	Fits
45910	Replacement shank	14,000 / 1,400 lbs.	2" x 2"	11" and 12"	45900
45911	Replacement shank	6,000 / 600 lbs.	2" x 2"	11" and 12"	45901
45917	Replacement shank	20,000 / 2,000 lbs.	2 1/2" x 2 1/2"	11" and 12"	45902
45912 NEW	Replacement dual-ball	See 45900	--	--	45910 & 45911 shanks
45923 NEW	Replacement dual-ball	See 45902	--	--	45917 shank
23556	Lock set, 5/8" diameter	--	--	--	2" and 2 1/2" receiver tubes and channel mounts
45915*	Replacement pins, 5/8" diameter	--	--	4 1/4"	2" channel mounts
45925	Replacement pins, 5/8" diameter	--	--	4 1/2"	2" and 2 1/2" channel mounts
45916	Anti-rattle replacement kit	--	--	--	All adjustable channel mounts

* Continued while supplies last

2

INCH

ADJUSTABLE TRI-BALL MOUNT

- Fits any 2" x 2" receiver tube opening
- Adjustable height allows for precise trailer leveling
- Includes three 5/8" diameter pins & clips



Bulk#	Pkg#	Description	GTW	Ball Diameter	Max Drop	Max Rise	Length
--	45799	Complete tri-ball assembly	6,000 / 7,500 / 10,000 lbs.	1 7/8", 2", 2 5/16"	5 3/4"	5 3/4"	16"
45800	--	Replacement tri-ball head for 45799	6,000 / 7,500 / 10,000 lbs.	1 7/8", 2", 2 5/16"	--	--	--
45059	--	Adjustable shank for 45799 or 45008	10,000 lbs.	--	5 3/4"	5 3/4"	8 3/4"
45802	--	Replacement tube mount for 45799	10,000 lbs.	--	--	--	--

2

INCH

ADJUSTABLE MULTI-PURPOSE BALL MOUNT

- Fits any 2" x 2" receiver tube opening
- Features two welded trailer balls and removable clevis bar for lunette eyes
- Adjustable height allows for precise trailer leveling
- Includes three 5/8" diameter pins & clips (#45049)
- Patent# 8,534,695



Bulk#	Pkg#	Description	Ball Diameter and Maximum GTW / TW		Max Drop	Max Rise	Length
			2"	2 5/16"			
--	45049	Complete mount and shank assembly	7,500 / 750 lbs.	10,000 / 1,000 lbs.	6 1/2"	6 11/16"	14 3/16"
45008	--	Replacement head for 45049	7,500 / 750 lbs.	10,000 / 1,000 lbs.	--	--	--
45059	--	Adjustable shank for 45008 or 45799	10,000 / 1,000 lbs. - no ball included		--	--	--

2

INCH

ADJUSTABLE BALL MOUNT

- Fits any 2" x 2" receiver tube opening
- Adjusts in 1 1/2" increments for precise trailer leveling
- Hollow shank can be used with an anti-rattle kit
- Includes pin & clip (#21500)

Part#	GTW / TW	Max Drop	Max Rise	Length	Hole Size	Finish
45812	5,000 / 500 lbs.	7 1/2"	6 1/4"	12 1/2"	1"	Gloss black



2 INCH MULTI-BALL MOUNTS

- Fits any 2" x 2" receiver tube opening
- Allows for quick switching between trailer ball sizes
- Permanently attached trailer balls cannot be loosened or stolen
- Hollow shanks can be used with an anti-rattle kit



Part#	Trailer Balls	Ball Diameter and Maximum GTW / TW			Length	Shank Type	Ball Finish	Shank Finish
		1 7/8"	2"	2 5/16"				
45660	2	--	7,500 / 750 lbs.	10,000 / 1,000 lbs.	8 1/2"	Solid	Black	Gloss black
45665	2	--	7,500 / 750 lbs.	10,000 / 1,000 lbs.	8 1/2"	Solid	Chrome	Gloss black
45002	2	--	7,500 / 750 lbs.	10,000 / 1,000 lbs.	8 1/2"	Hollow	Chrome	Gloss black
45675*	3	3,500 / 350 lbs.	5,000 / 500 lbs.	10,000 / 1,000 lbs.	7" and 8 1/2"	Solid	Chrome	Gloss black
45650	3	5,000 / 500 lbs.	7,500 / 750 lbs.	10,000 / 1,000 lbs.	7" and 8 1/2"	Solid	Black	Gloss black
45655	3	5,000 / 500 lbs.	7,500 / 750 lbs.	10,000 / 1,000 lbs.	7" and 8 1/2"	Solid	Chrome	Gloss black
45001	3	5,000 / 500 lbs.	7,500 / 750 lbs.	10,000 / 1,000 lbs.	7" and 8 1/2"	Hollow	Chrome	Gloss black

* Tow hook limited to trailer hitch capacity

2 INCH REVERSIBLE BALL MOUNTS

- Fits any 2" x 2" receiver tube opening
- Allows for quick switching between trailer ball sizes and drop or rise
- Permanently attached trailer balls cannot be loosened or stolen
- Hollow shanks can be used with an anti-rattle kit



Part#	Ball Diameter and Maximum GTW / TW			Drop	Rise	Length	Shank Type	Finish
	1 7/8"	2"	2 5/16"					
45643	6,000 / 600 lbs.	7,500 / 750 lbs.	--	4" (1 7/8" ball)	2" (2" ball)	10 1/2"	Hollow	Gloss black
45644	--	7,500 / 750 lbs.	7,500 / 750 lbs.	4" (2" ball)	2" (2 5/16" ball)	10 1/2"	Hollow	Gloss black

2

INCH

LOADED BALL MOUNTS

- Fits any 2" x 2" receiver tube opening
- Includes a factory-torqued trailer ball and pin & clip
- Three-packs include an informative point-of-purchase tray
- Hollow shanks can be used with an anti-rattle kit

45037
multi-pack45034 (1 7/8" ball)
45036 (2" ball)
45041 (2 5/16" ball)45293 (1 7/8" ball)
45295 (2" ball)45055 (1 7/8" ball)
45056 (2" ball)
45042 (2 5/16" ball)

45331



45332

Part#	White Box#	Three-Pack#	GTW / TW	Ball Diameter	Drop	Length	Shank Type	Finish
45034	--	45035	3,500 / 350 lbs.	1 7/8" (40002)	2"	8 1/4"	Hollow	Gloss black
--	45293	--	3,500 / 350 lbs.	1 7/8" (40002)	2"	8 1/4"	Hollow	Chrome
45036	--	45037	7,500 / 750 lbs.	2" (40037)	2"	8 1/4"	Hollow	Gloss black
--	45295	--	7,500 / 750 lbs.	2" (40037)	2"	8 1/4"	Hollow	Chrome
45041	--	45041003	7,500 / 750 lbs.	2 5/16" (40005)	2"	8 1/4"	Hollow	Gloss black
45331	--	--	15,000 / 1,500 lbs.	2 5/16" (40030)	2"	8 1/2"	Solid	Carbide
45055	--	--	3,500 / 350 lbs.	1 7/8" (40002)	4"	8 1/4"	Hollow	Gloss black
45056	--	45057	7,500 / 750 lbs.	2" (40037)	4"	8 1/4"	Hollow	Gloss black
45042	--	45042003	7,500 / 750 lbs.	2 5/16" (40005)	4"	8 1/4"	Hollow	Gloss black
45332	--	--	15,000 / 1,500 lbs.	2 5/16" (40030)	4"	8 1/2"	Solid	Carbide

2

INCH

FUSION BALL MOUNTS

- Fits any 2" x 2" receiver tube opening
- Includes a welded trailer ball and pin & clip
- Permanently attached trailer ball cannot be loosened or stolen
- Two-mount multi-packs include an informative point-of-purchase tray
- Hollow shanks can be used with an anti-rattle kit

45131 (1 7/8" ball)
45134 (2" ball)45151 (1 7/8" ball)
45154 (2" ball)45152 (1 7/8" ball)
45155 (2" ball)45136
Two-pack45158
Two-pack

Part#	Two-Pack#	GTW / TW	Ball Diameter	Drop	Rise	Length	Finish
45131	45136	5,000 / 500 lbs.	1 7/8"	2"	--	7 1/2"	Gloss black
45134	45139	7,500 / 750 lbs.	2"	2"	--	7 1/2"	Gloss black
45151	45156	5,000 / 500 lbs.	1 7/8"	4"	--	8 1/8"	Gloss black
45154	45158	7,500 / 750 lbs.	2"	4"	--	8 1/8"	Gloss black
45152	--	5,000 / 500 lbs.	1 7/8"	--	2"	8 1/8"	Gloss black
45155	--	7,500 / 750 lbs.	2"	--	2"	8 1/8"	Gloss black

2 INCH CLEVIS PIN BALL MOUNT

- Fits any 2" x 2" receiver tube opening
- Clevis pin accepts a tow hook or strap
- Can also be used as a standard ball mount
- Includes clevis pin (trailer ball sold separately)
- Solid steel shank for optimum strength



45821

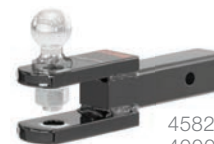

45821 shown with 40004 ball (not included)

Part#	GTW / TW	Length	Hole Size	Finish
45821	6,000 / 600 lbs.	8 3/4"	1"	Gloss black

2 INCH SWAY TAB BALL MOUNT

- Fits any 2" x 2" receiver tube opening
- Provides a mounting tab for a sway control trailer ball (ball sold separately)
- Hollow shank can be used with an anti-rattle kit
- See page 316 for sway control units and balls



45820



45820 shown with 40093 ball (not included)



Sway control 17200 attached

Part#	GTW / TW	Drop	Rise	Length	Hole Size
45820	7,500 / 750 lbs.	2"	3/4"	7 1/2"	1"

1 1/4 INCH & 2 INCH VERTICAL RECEIVER TUBE BALL MOUNTS

- Converts a vertical receiver tube into a ball mount tongue (#45507, #45003)
- Adapts a 2" vertical receiver into a 2" standard receiver (#45013)



45507



45003



45013

Part#	Shank Size	GTW / TW	Hole Size	Adapts From	Adapts To	Length	Finish
45507	1 1/4"	3,500 / 300 lbs.	3/4"	Vertical 1 1/4"	Ball mount tongue	9 3/4"	Gloss black
45003	2"	4,000 / 400 lbs.	1"	Vertical 2"	Ball mount tongue	9"	Gloss black
45013	2"	5,000 / 500 lbs.	--	Vertical 2"	Standard 2"	4 1/4"	Gloss black

2

INCH

WELDED D-RING BALL MOUNT

- Fits any 2" x 2" receiver tube opening
- Welded D-ring accepts tow straps or hooks
- Angled shank allows for easier insertion into the receiver tube
- Hollow shank can be used with an anti-rattle kit
- Patent# 8,226,107



45004

Part#	GTW / TW	Drop	Rise	Length	Hole Size	Finish
45004	7,500 / 750 lbs. drop	6"	4"	10"	1"	Gloss black
	6,000 / 600 lbs. rise					



Easy to insert into receiver tube

2

INCH

&**2 1/2**

INCH

TOW HOOK MOUNTS

- Fits 2" or 2 1/2" receiver tube openings
- GTW and TW are limited to trailer hitch capacity



45831

NEW

45832

NEW

45825



45500



45832 with strap

Part#	Shank Size	Description	Length	Finish
45831 NEW	2 1/2"	Use with tow straps, complete with shackle and solid shank	7 1/2"	Carbide
45832 NEW	2"	Use with tow straps, complete with shackle and solid shank	7 1/2"	Carbide
45825	2"	Use with 83066 vehicle recovery strap or similar	7 1/2"	Gloss black
45500	2"	Use with 83066 vehicle recovery strap or similar	10"	Carbide

TOW HOOKS & TOW STRAP

- Commonly used on 4WD pickups, SUVs and vans
- Constructed from forged, heat-treated steel
- Spring clip provides added security for rope or strap attachment

See page 335 for chain options



83066



22420



22430



22401



22411

Bulk#	Pkg#	Capacity	Break Strength	Finish	Description
--	22401	10,000 lbs.	--	Chrome-plated	Tow hook with hardware
--	22411	10,000 lbs.	--	Black	Tow hook with hardware
22420	--	10,000 lbs.	--	Chrome-plated	Tow hook
22430	--	10,000 lbs.	--	Black	Tow hook
83066	--	9,000 lbs. GVW	18,000 lbs.	Nylon	Tow strap, 2" wide by 30' long

2 INCH SPECIALTY MOUNTS

 Weight capacities limited to the lowest rated towing component

- Fits any 2" x 2" receiver tube opening
- Top receiver increases ground clearance for a cargo carrier or other hitch-mounted accessories
- Top receiver not for towing use
- Provides two receiver tubes for multiple accessories, such as a cargo carrier and a ball mount (#45792)
- Ideal for carrying a bike rack while towing a trailer (#45810)



45794



45792



45794 gives added ground clearance



45792 provides two receiver tubes



45810 provides a ball mount and receiver tube to tow a trailer and an additional accessory



45810

Part#	Description	GTW / TW	Drop	Rise	Length	Hole Size	Finish
45794	Raised receiver adapter	Not for towing use / 350 lbs.	--	4 1/4"	5 1/4"	--	Gloss black
45792	Dual receiver extender with pin & clip	3,500 / 350 lbs.	--	5 13/16"	8"	--	Gloss black
45810	Multi-use ball mount with pin & clip	7,500 / 750 lbs.	2"	5 13/16"	12 1/4"	1"	Gloss black

ATV

2 INCH

ATV TOWING STARTER KITS

- Includes 3-in-1 ATV ball mount, bolt-on ATV adapter and pin & clip
- Never exceed the ATV's maximum tow rating
- Ball mount features a trailer ball, 5/8" hole and a clevis pin
- Adapter bolts onto ATV tongue to provide a 2" x 2" receiver tube
- Welded D-ring accepts tow straps or hooks
- Patent# 8,915,514 and 8,276,932



45029



Installs on ATV and provides a variety of hook-up options



45005



Clevis pin accepts hook or strap for straight-line pull



45006



No-swivel design



Converts an ATV platform into a 2" receiver tube

Pkg#	Ball Diameter	Rise	Length	Hole Size	Finish
Starter Kits					
45029	1 7/8"	1/4"	6"	5/8"	Gloss black
45038	2"	1/4"	6"	5/8"	Gloss black
Ball Mounts					
45005	1 7/8"	1/4"	6"	5/8"	Gloss black
45009	2"	1/4"	6"	5/8"	Gloss black
Bolt-On Adapter					
45006	--	--	--	--	Gloss black

1 1/4
INCH

&

2
INCH

TRAILER HITCH RECEIVER TUBE EXTENDERS

- Provides added clearance for a trailer or hitch-mounted accessory
- Shank constructed from solid steel for optimum strength
- Protected by a durable powder coat finish



Part#	Extends	Shank Size	GTW / TW
45789	7"	1 1/4"	Not for towing use / 350 lbs.
45791	8"	2"	3,500 / 350 lbs.
45795	14"	2"	3,500 / 350 lbs.
45796	18"	2"	3,500 / 350 lbs.

Measuring extenders and adapters

Length is measured between pin-holes, from center to center



1 1/4
INCH

→

2
INCH

←

2 1/2
INCH

TRAILER HITCH RECEIVER TUBE ADAPTERS

- Adapts a receiver tube opening to a different size
- #45048 can be cut down from 34" to 24" and has integrated safety chain loops and an electrical bracket
- Protected by a durable powder coat finish



Part#	Adapts From	Adapts To	GTW / TW	Weight Dist. GTW / TW	Length	Finish
45785	1 1/4"	2"	Not for towing use / 350 lbs.	--	6 1/4"	Gloss black
45790	1 1/4"	2"	Not for towing use / 350 lbs.	--	10"	Gloss black
45770	2"	1 1/4"	3,500 / 350 lbs.	--	4"	Gloss black
45775	2"	1 1/4"	3,500 / 350 lbs.	--	9 1/2"	Gloss black
45780	2"	1 1/4"	3,500 / 350 lbs.	--	15"	Gloss black
45013	Vertical 2"	Standard 2"	5,000 / 500 lbs.	--	4 1/4"	Gloss black
45048	2 1/2"	2"	4,500 / 450 lbs.	6,000 / 600 lbs.	34"	Gloss black
			6,000 / 600 lbs.	8,000 / 800 lbs.	24"	

3 INCH → **2 1/2** INCH → **2** INCH **REDUCER SLEEVES**

- #45405 reduces a 2 1/2" x 2 1/2" receiver tube opening to fit a 2" x 2" shank
- #45408 two-piece set reduces a 3" receiver tube opening to fit a 2 1/2" shank or 2" shank
- GTW and TW are limited to trailer hitch capacity

Part#	Reduces From	Reduces To	Length	Finish
45405	2 1/2"	2"	5 1/2"	Carbide
45408 NEW	3"	2 1/2"	6 1/4"	Carbide
	2 1/2"	2"		

How to use a reducer sleeve

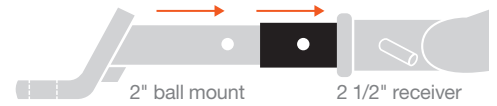

NEW



45405



45408



45408 set

REDUCER BUSHINGS

- Reduces hole size, allowing use of trailer balls with smaller shank diameters

Bulk/#	Pkg#	Reduces From	Reduces To	Finish
21100	21101	1"	3/4"	Yellow zinc-plated
21200	21201	1 1/4"	1"	Yellow zinc-plated
21300	21301	1 3/8"	1 1/4"	Yellow zinc-plated



21100



21200



21300



21301

BALL MOUNT TONGUE SLEEVE

- Allows for single-wrench trailer ball torquing
- For use with CURT and other 'wrench flat' trailer balls
- See our trailer ball hex-end wrench on page 220
- Patent# 8,376,387

Pkg#	Fits	Hole Size	Finish
45007	2 1/2" tongue width	1"	Gloss black



45007

TOW POUCH

- Stores ball mount, trailer balls, hitch pins and other accessories
- Keeps hands and vehicle interior clean



22200

Part#	Width	Length
22200	11 1/2"	17 1/2"

PINTLES & LUNETTE EYES

FORGED PINTLE HOOKS & COMBINATIONS

For pintle mount options go to page 215

- Mounts on any CURT adjustable pintle mount
- Spring-loaded locking arm for secure coupling
- Constructed from solid, forged steel for superior strength
- Changeable trailer ball features a hard chrome finish
- Includes safety pin and bolt kit



48180



48190



48200



Pintle hook coupled to a lunette eye



Ball & pintle combo attached to coupler



48205



48210



48215



48230

Bulk#	Pkg#	Pintle GTW	Vertical Load	Ball GTW	Ball Diameter	Fits Lunette Eye	Finish
Ball & Pintle Combinations							
--	48180	16,000 lbs.	1,600 lbs.	6,000 lbs.	1 7/8"	2 1/2" or 3" I.D.	Black
--	48190	16,000 lbs.	1,600 lbs.	10,000 lbs.	2"	2 1/2" or 3" I.D.	Black
--	48200	16,000 lbs.	1,600 lbs.	16,000 lbs.	2 5/16"	2 1/2" or 3" I.D.	Black
Pintle Hooks							
--	48205	10,000 lbs.	2,000 lbs.	--	--	2 1/2" or 3" I.D.	Black
--	48210	20,000 lbs.	4,000 lbs.	--	--	2 1/2" or 3" I.D.	Black
--	48215	30,000 lbs.	8,000 lbs.	--	--	2 1/2" or 3" I.D.	Black
--	48230*	60,000 lbs.	12,000 lbs.	--	--	2 1/2" or 3" I.D.	Black
Replacement Bolt Kits							
48330	-Four 12mm x 50mm hex bolts (class 10.9) -Four 12mm hex nuts (class 8) -Four 12mm lock washers						Yellow zinc-plated
48331*	-Four 12mm x 50mm socket head cap screws (class 12.9) -Four 12mm nylock hex nuts (class 8) -Four 12mm lock washers						Black oxide



48330

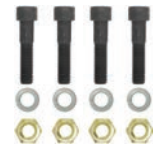

48331 - for part# 48230

* Required for #48230 to reach 60,000 lbs. gross trailer weight

2 INCH & 2 1/2 INCH ADJUSTABLE PINTLE MOUNTS

- Mounts any CURT adjustable pintle hook or ball & pintle combination
- Height adjustment allows for precise trailer leveling
- Bent face plate and solid shank provide superior strength (#48343, #48339)
- 2 1/2" shank options ideal for class 5 Commercial Duty hitches (page 15)
- Protected by a highly durable carbide powder coat finish
- Protective cardboard sleeve and full-color retail label

Measuring a pintle mount

See table for corresponding measurements

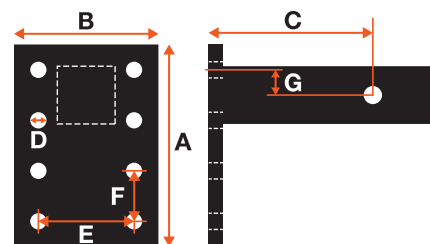

Part#	GTW	Pintle Positions	Plate Height (A)	Plate Width (B)	Shank Length (C)	Hole Size (D)	Hole Space (E)	Hole Space (F)	Top Hole Height (G)
For 2" x 2" Receiver Tube Openings									
48326	20,000 lbs.	1-position	3 1/2"	5"	6"	9/16"	3 5/16"	1 3/4"	7/8"
48327	20,000 lbs.	1-position	3 1/2"	5"	8"	9/16"	3 5/16"	1 3/4"	7/8"
48323	10,000 lbs.	3-position	7"	5"	6"	9/16"	3 5/16"	1 3/4"	7/8"
48324	10,000 lbs.	3-position	7"	5"	8"	9/16"	3 5/16"	1 3/4"	7/8"
48328	15,000 lbs.	3-position	7"	5"	6"	9/16"	3 5/16"	1 3/4"	7/8"
48325	15,000 lbs.	3-position	7"	5"	8"	9/16"	3 5/16"	1 3/4"	7/8"
48343	17,000 lbs.	3-position	7 1/4"	6 1/2"	6"	9/16"	3 5/16"	1 3/4"	7/8"
48341	10,000 lbs.	6-position	13"	5"	10"	9/16"	3 5/16"	1 3/4"	7/8"
48342	10,000 lbs.	6-position	13"	5"	12"	9/16"	3 5/16"	1 3/4"	7/8"
For 2 1/2" x 2 1/2" Receiver Tube Openings									
48340	20,000 lbs.	1-position	3 1/2"	5"	8"	9/16"	3 5/16"	1 3/4"	7/8"
48329	18,000 lbs.	3-position	7"	5"	8"	9/16"	3 5/16"	1 3/4"	7/8"
48339	20,000 lbs.	3-position	7 1/4"	6 1/2"	6 3/8"	9/16"	3 5/16"	1 3/4"	1 1/4"
Replacement Bolt Kit									
48330	-Four 12mm x 50mm hex bolts (class 10.9) -Four 12mm hex nuts (class 8) -Four 12mm lock washers								

2 INCH & **2 1/2** INCH

FORGED RECEIVER-MOUNT PINTLE HOOKS & COMBINATIONS

- Fits 2" or 2 1/2" receiver tube openings
- Spring-loaded locking arm for secure coupling
- Constructed from solid, forged steel for superior strength
- 2 1/2" shank ideal for class 5 Commercial Duty hitches (#48010, #48012)
- Protected by a durable powder coat finish
- Changeable trailer ball features a hard chrome finish
- Includes safety pin with chain or cable



Part#	GTW	Ball Capacity	Fits Receiver Tube Size	Ball Size	Overall Length	Ball Length	Hook Length	Fits Lunette Eye
Receiver-Mount Ball & Pintle Combinations								
48006	16,000 lbs.	12,000 lbs.	2"	2 5/16"	15 1/4"	11 1/4"	9 1/2"	2 1/2" or 3" I.D.
48007	16,000 lbs.	10,000 lbs.	2"	2"	15 1/4"	11 1/4"	9 1/2"	2 1/2" or 3" I.D.
48012	20,000 lbs.	20,000 lbs.	2 1/2"	2 5/16"	15"	11"	9 1/2"	2 1/2" or 3" I.D.
Receiver-Mount Pintle Hooks								
48005	10,000 lbs.	--	2"	--	14 1/2"	--	9 1/2"	2 1/2" I.D.
48004	20,000 lbs.	--	2"	--	14 1/2"	--	9 1/2"	2 1/2" I.D.
48010	20,000 lbs.	--	2 1/2"	--	14 3/4"	--	9 1/2"	2 1/2" I.D.

FORGED MOUNT-STYLE LUNETTE EYES

- Smooth back plate for flush mounting
- Four-bolt pattern for simple, secure attachment
- Constructed from forged steel alloy for superior strength



Pkg#	GTW	Eye Hole Size	Ring Thickness	Bolt Hole Spacing	Base Size	Finish
48550	35,000 lbs.	2 1/2" I.D.	1 1/2"	4 1/2" center to center	6" square	Black
48560	60,000 lbs.	3" I.D.	1 1/2"	4 1/2" center to center	6" square	Black

FORGED LUNETTE EYES

- Single stud eliminates need for a swivel-type pintle hook
- Threaded shank and castle nut for secure attachment to trailer
- Flat design allows drawbar to bolt quickly and easily to a trailer tongue
- Constructed from forged steel alloy for superior strength



48520



48530



48510



Using pintle hook



Using clevis bar

Part#	GTW	Eye Hole Size	Bar Width	Bar Length	Bar Thickness	Finish	Description
48520	15,000 lbs.	2 1/2" I.D.	--	--	--	Black	Lunette eye with nut
48530	45,000 lbs.	3" I.D.	--	--	--	Black	Lunette eye with nut
48510	22,000 lbs.	3" I.D.	3"	13"	1 5/8"	Black	Lunette eye drawbar, seven-bolt

CHANNELS & FORGED LUNETTE EYES

- Height adjustment allows for precise trailer leveling
- 2" bolt pattern spread for simple, secure attachment
- Constructed from forged steel for superior strength
- Channel brackets feature one-piece, formed steel construction



48601



48660



48610



48650



48630



48631



48640



48620

Bulk#	Pkg#	GTW	Number of Positions	Eye Hole Size	Bolt Hole Spacing	Channel Width	Channel Height	Description
48600	--	12,000 lbs.	--	3" I.D.	--	--	--	Forged lunette eye
48601	--	12,000 lbs.	--	3" I.D.	--	--	--	Forged lunette eye, black
48660	--	24,000 lbs.	--	3" I.D.	--	--	--	Forged lunette eye
48631	48630	12,000 lbs.	3-position	3" I.D.	2" on center	3 1/2" I.D.	7 1/2"	Forged lunette eye with channel
48610	--	--	3-position	--	2" on center	3 1/2" I.D.	7 1/2"	Formed channel
48650	--	--	5-position	--	2" on center	3 1/2" I.D.	11 3/4"	Formed channel
48640	--	12,000 lbs.	5-position	3" I.D.	2" on center	3 1/2" I.D.	11 3/4"	Forged lunette eye with channel
48620	Grade-8 bolt kit includes two of each of the following: hex bolts (5/8" x 5 1/2"), hex bolts (1/2" x 1 1/2"), nylock hex nuts (5/8"), flat washers (1/2") and flat washers (5/8")							

TRAILER BALLS

- Chrome-plated, stainless steel or raw trailer balls available
- Fine threads provide superior holding strength
- Tested for safety to meet U.S. VESC specifications

Stainless steel



40051
Bulk tag



40081
Packaged

Chrome-plated



40090
Bulk tag



40069
Packaged

Raw



40088
Bulk tag

Measuring a trailer ball

- A: Ball diameter
- B: Shank length
- C: Shank diameter
- D: Rise

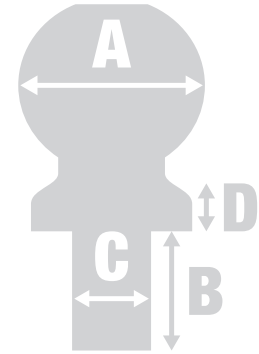

Torque specs (lb. - ft.)

- 3/4" shank: 160
- 1" shank: 250
- 1 1/4" shank: 450
- 2" shank: 4,550

Shank Diameter	Shank Length	Rise	GTW	Chrome Bulk#	Chrome Pkg#	Stainless Bulk#	Stainless Pkg#	Raw Bulk#
1 7/8" Ball Diameter								
3/4"	1 5/8"	0"	2,000 lbs.	40001	40061	--	--	--
3/4"	2 1/8"	0"	2,000 lbs.	40015	40063	40050	40080	--
3/4"	3"	0"	2,000 lbs.	40016	40071	--	--	--
1"	2 1/8"	0"	3,500 lbs.	40002	40062	40051	40081	--
1"	2 1/8"	2"	3,500 lbs.	40032	--	--	--	--
1"	2 3/16"	1"	3,500 lbs.	40031	--	--	--	--
1"	3"	0"	3,500 lbs.	40017	40072	--	--	--
2" Ball Diameter								
3/4"	1 3/4"	0"	3,500 lbs.	40003	40064	--	--	--
3/4"	2 1/8"	0"	3,500 lbs.	40018	40065	40052	40082	--
3/4"	3"	0"	3,500 lbs.	40019	40073	--	--	--
1"	2 1/8"	0"	6,000 lbs.	40004	40066	40053	40083	--
1"	2 1/8"	0"	7,500 lbs.	40037	--	--	--	--
1"	2 1/8"	1"	6,000 lbs.	40033	--	--	--	--
1"	2 1/8"	2"	6,000 lbs.	40034	--	--	--	--
1"	2 1/4"	0"	12,000 lbs.	40038*	--	--	--	--
1"	3"	0"	6,000 lbs.	40020	40074	--	--	--
1 1/4"	2 5/8"	0"	10,000 lbs.	40090	40069	--	--	--
2 5/16" Ball Diameter								
1"	2 1/8"	0"	7,500 lbs.	40005	40067	40054	40084	--
1"	2 1/4"	0"	10,000 lbs.	40007	--	--	--	--
1"	2 1/4"	0"	12,000 lbs.	40039*	--	--	--	40042*
1"	3"	0"	6,000 lbs.	40021	40075	--	--	--
1 1/4"	2 5/8"	0"	10,000 lbs.	40006	40068	--	--	--
1 1/4"	2 5/8"	0"	15,000 lbs.	40030*	--	--	--	--
1 1/4"	2 3/4"	0"	20,000 lbs.	40008*	--	--	--	--
1 1/4"	2 5/8"	0"	30,000 lbs.	--	--	--	--	40085*
1 1/4"	2 5/8"	1"	10,000 lbs.	40035	--	--	--	--
1 1/4"	2 5/8"	1"	25,000 lbs.	--	--	--	--	40086*
1 1/4"	2 5/8"	2"	10,000 lbs.	40036	--	--	--	--
1 1/4"	2 5/8"	2"	25,000 lbs.	--	--	--	--	40087*
1 1/4"	3"	0"	6,000 lbs.	40022	40076	--	--	--
2"	3 1/2"	0"	30,000 lbs.	--	--	--	--	40088**
3" Ball Diameter								
2"	3 1/2"	0"	30,000 lbs.	--	--	--	--	40089**

*Heat-treated

**Heat-treated, coarse-threaded

SWITCH BALL™ TRAILER BALLS

- Exclusive 'J' groove design for secure attachment to the shank
- No tools, coins or pins required for trailer ball install or removal
- Shank bears the weight, freeing the coupler from binding
- Built from high-strength steel
- Protected by a premium grade, nickel chrome-plated finish
- Neck covers protect the Switch Ball™ neck from the elements when not in use
- Tested for safety in accordance with SAE J684
- U.S. patent# 5,169,168; Canadian patent# 1,325,445

Features

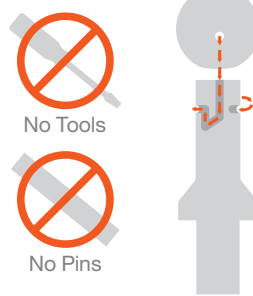

Measuring a Switch Ball™

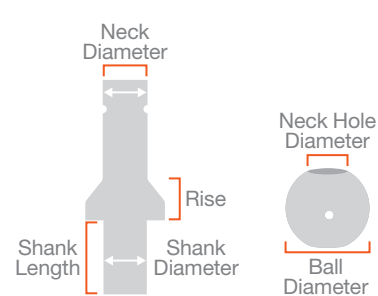

Place the ball on the shank



Twist the ball down onto the shank to lock



Bulk#	Pkg#	Ball Diameter and GTW			Shank GTW	Shank Length	Shank Diameter	Neck Diameter	Neck Hole Diameter	Rise	Finish
		1 7/8"	2"	2 5/16"							
Switch Ball™ Trailer Ball Sets											
--	42178	3,500 lbs.	6,000 lbs.	--	--	2 1/4"	1"	1"	--	0"	Chrome-plated
--	42225	3,500 lbs.	6,000 lbs.	8,000 lbs.	--	2 1/4"	1"	1 1/8"	--	3/4"	Chrome-plated
--	42280	--	6,000 lbs.	8,000 lbs.	--	2 1/4"	1"	1 1/8"	--	3/4"	Chrome-plated
-	41782	3,500 lbs.	6,000 lbs.	--	--	1 5/8"	3/4"	1"	--	0"	Chrome-plated
--	41783	3,500 lbs.	6,000 lbs.	--	--	2 1/4"	3/4"	1"	--	0"	Chrome-plated
Switch Ball™ Neck Covers											
--	41352	--	--	--	--	--	--	1"	--	--	Black rubber
--	41353	--	--	--	--	--	--	1"	--	--	Red rubber
--	41354	--	--	--	--	--	--	1 1/8"	--	--	Black rubber
--	41355	--	--	--	--	--	--	1 1/8"	--	--	Red rubber
Replacement Trailer Balls											
41780	--	6,000 lbs.	--	--	--	--	--	--	1"	--	Chrome-plated
42780	--	8,000 lbs.	--	--	--	--	--	--	1 1/8"	--	Chrome-plated
41200	--	--	6,000 lbs.	--	--	--	--	--	1"	--	Chrome-plated
42200	--	--	8,000 lbs.	--	--	--	--	--	1 1/8"	--	Chrome-plated
42203	--	--	--	8,000 lbs.	--	--	--	--	1 1/8"	--	Chrome-plated
Replacement Shanks											
41340	--	--	--	--	3,500 lbs.	1 5/8"	3/4"	1"	--	0"	Chrome-plated
41341	--	--	--	--	3,500 lbs.	2 1/4"	3/4"	1"	--	0"	Chrome-plated
42100	--	--	--	--	6,000 lbs.	2 1/4"	1"	1"	--	0"	Chrome-plated

TRAILER BALL COVERS

- Protects trailer ball when not in use

Bulk#	Pkg#	Finish	Fits
21800	21801	Black rubber	1 7/8" and 2" trailer balls
21810	21811	Black rubber	2 5/16" trailer balls



REPLACEMENT NUTS & WASHERS

- Fits trailer ball shanks with fine threads
- Helical lock washer ensures a secure mount
- Constructed from zinc-plated steel
- Tested for safety to meet U.S. VESC V-5 specifications



Pkg#	Torque Specification	Description
40103	160 ft. lbs.	3/4" nut and lock washer
40104	250 ft. lbs.	1" nut and lock washer
40105	450 ft. lbs.	1 1/4" nut and lock washer

REPLACEMENT PINTLE BALLS

- Fits lunette eyes with a 2 1/2" or 3" inside diameter
- Fine threads and self-securing nylock nut provide secure mounting
- Constructed from high-strength, drop-forged steel
- Protected by a hard chrome-plated finish



Bulk#	Ball Diameter	Shank Diameter	GTW
48810	1 7/8"	1 1/4"	6,000 lbs.
48820	2"	1 1/4"	10,000 lbs.
48830	2 5/16"	1 1/4"	12,000 lbs.

TRAILER BALL BOX-END WRENCH

- Six-point design ensures the best grip and protects against rounding of the nut
- Forged, hardened steel construction with a durable chrome plating



Part#	Length	Wrench Sizes	Fits
20001	15 1/2"	1 1/8" and 1 1/2"	3/4" and 1" shanks

REPLACEMENT SWAY CONTROL BALL

- Fits the sway control unit #17200, sway tab ball mount #45820 or weld-on sway tab #45822
- Sway control helps reduce lateral trailer movement
- Constructed from zinc-plated steel



Bulk#	Ball Diameter	Shank Diameter	Shank Length
40093	1 1/4"	5/8"	1 3/4"

DOUBLE LOCK GOOSENECK BALLS

- Trailer balls fit all original Double Lock gooseneck hitches
- #60616 also fits Double Lock EZr™ gooseneck hitches



60616



60602



60603

Bulk#	Pkg#	Description	Ball Size	Ball Rise	Ball Offset	GTW / Vertical Load
60616	--	Replacement ball for EZr™ and Double Lock goosenecks	2 5/16"	--	--	30,000 / 7,500 lbs.
--	60602	Moves pivot point rearward for added cab clearance	2 5/16"	--	4"	20,000 / 5,000 lbs.
--	60603	Adds clearance for trucks with plastic or rubber bed liners	2 5/16"	1"	--	30,000 / 7,500 lbs.

REPLACEMENT OEM PUCK SYSTEM GOOSENECK BALLS

- Requires OEM puck system to install into the vehicle
- Installs easily with quarter-turn latch locking system
- Retention balls keep shank fully locked into the hitch
- Constructed from strong, machine-forged steel alloy
- Protected by a polished chrome-plated mirror finish
- Tested for safety to meet U.S. VESC V-19 specifications
- Patent# 8,955,866



60601 factory-style gooseneck ball operates with a simple, 1/4-turn latch-locking system



60601

60629

Part#	Make	Ball Size	Description	Finish	GTW / Vertical Load
60601	Ford and Ram	2 5/16"	OEM-compatible gooseneck ball	Chrome-plated	30,000 / 7,500 lbs.
60629	Chevrolet / GMC, Ford and Nissan	2 5/16"	OEM-compatible gooseneck ball	Chrome-plated	30,000 / 7,500 lbs.

WELD-ON GOOSENECK BALL

- Constructed from high-strength, ready-to-weld steel alloy
- Heat-treated for optimum strength and durability
- Tested for safety to meet U.S. VESC V-5 specifications



40094

Part#	Ball Size	GTW	Fits
40094	2 5/16"	30,000 lbs	2 5/16" gooseneck couplers

TOWING SECURITY

HITCH & COUPLER LOCK SETS

- Locks keyed alike for convenient one-key operation
- Easy-to-operate, 1/4-turn lock activation
- Watertight dust caps prevent internal corrosion
- Four keys included for added convenience
- Space-saving, retail packaging



Pkg#	Fits Receiver Tube Opening	Fits Latch Span	Fits Coupler	Lock Pin Diameter	Coupler Pin Diameter	Finish	Description
23526	2" x 2"	7/8"	--	5/8"	1/4"	Chrome-plated	Hitch lock (23515) & coupler lock (23520)
23527	2" x 2"	2 1/2"	--	5/8"	1/4"	Chrome-plated	Hitch lock (23515) & coupler lock (23522)
23505	2" x 2"	Adjustable from 1" to 3"	--	5/8"	1/4"	Chrome-plated	Hitch lock & coupler lock (23503)
23086	2" x 2"	Adjustable from 1/2" to 2 1/2"	1 7/8" & 2" flat lip couplers	5/8"	1/4"	Chrome-plated (hitch & coupler lock) Grey powder coat (trailer coupler lock)	Hitch lock, coupler lock & trailer coupler lock (23079)
23088	2" x 2"	Adjustable from 1/2" to 2 1/2"	2" & 2 1/2" flat lip couplers	5/8"	1/4"	Chrome-plated (hitch & coupler lock) Grey powder coat (trailer coupler lock)	Hitch lock, coupler lock & trailer coupler lock (23081)

HITCH LOCKS

- Easy-to-operate, 1/4-turn lock activation
- Watertight dust cap prevents internal corrosion
- Two keys included for added convenience
- Space-saving, full-color retail packaging



Pkg#	Fits Receiver Tube Opening	Pin Diameter	Finish	Lock Style
23020	1 1/4" x 1 1/4"	1/2"	Chrome-plated	Dead bolt
23501	1 1/4" x 1 1/4"	1/2"	Chrome-plated	Barbell
23024	1 1/4" x 1 1/4"	1/2"	Chrome-plated	Dead bolt with adapter sleeve
	2" x 2"	5/8"		
23517	1 1/4" x 1 1/4"	1/2"	Stainless steel	Barbell with adapter sleeve
	2" x 2"	5/8"		
23506	1 1/4" x 1 1/4"	1/2"	Chrome-plated	Barbell, right angle with adapter sleeve
	2" x 2"	5/8"		
23515	2" x 2"	5/8"	Chrome-plated	Barbell
23530*	2" x 2"	5/8"	Chrome-plated	Barbell with anti-rattle
23516	2" x 2"	5/8"	Stainless steel	Barbell
23518	2" x 2"	5/8"	Black	Barbell
23502	2" x 2"	5/8"	Stainless steel with blue anodized aluminum	Barbell, right angle
23510	2" x 2"	5/8"	Chrome-plated	Barbell, right angle
23021	2" x 2"	5/8"	Chrome-plated	Dead bolt
	2 1/2" x 2 1/2"			
23528	2" x 2"	5/8"	Chrome-plated	Barbell
	2 1/2" x 2 1/2"			
23519	2" x 2"	5/8"	Stainless steel	Barbell
	2 1/2" x 2 1/2"			
23504	2" x 2"	5/8"	Chrome-plated	Barbell, right angle
	2 1/2" x 2 1/2"			

* Continued while supplies last

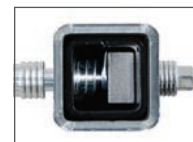

23530 assembled in trailer hitch receiver tube

COUPLER LATCH LOCKS

- Easy-to-operate, 1/4-turn lock activation
- Watertight dust cap prevents internal corrosion
- Two keys included for added convenience
- Space-saving, full-color retail packaging



Pkg#	Fits Latch Span	Pin Diameter	Finish	Lock Style
23546	3/4"	1/4"	Solid brass	Padlock
23022	3/4"	1/4"	Brass-plated	Padlock
23521	3/4"	1/4"	Black	Padlock
23520	7/8"	1/4"	Chrome-plated	Barbell
23522	2 1/2"	1/4"	Chrome-plated	Barbell
23523	3 3/8"	1/4"	Chrome-plated	Barbell
23503	Adjustable from 1" to 3"	1/4"	Chrome with blue anodized aluminum	Barbell, right angle



23503 coupler lock shown in trailer coupler

TRAILER COUPLER LOCKS

- Designed to deter trailer theft by preventing a trailer ball from being inserted into the coupler
- Two keys included for added convenience



Two different designs fit multiple coupler sizes to secure unattended trailers



Pkg#	Fits	Finish	Description
23079	1 7/8" and 2" couplers	Grey powder coat	Aluminum lock for flat lip couplers
23081	2" and 2 5/16" couplers	Grey powder coat	Aluminum lock for flat lip couplers
23659	Universal	Hammer-tone epoxy	Die-cast trailer lock with dual-ratchet locking system
23179	Universal	Ballistic grade nylon	Solid, hardened steel trailer lock with dual-ratchet locking system

5TH WHEEL HITCH LOCK

- Locks a 5th wheel hitch into the rails, taking the place of a pin & clip
- Extra-long 1/2" diameter pin fits all industry-standard base rails
- Rust-free aluminum housing with a durable black powder coat finish
- Weather-resistant dust cap helps prevent internal corrosion
- Easy-to-operate, 1/8-turn lock activation
- Includes two keys for added convenience

NEW



Locks a 5th wheel to industry-standard rails



23256

Pkg#	Pin Diameter	Finish
23256 NEW	1/2"	Black powder-coated aluminum

KINGPIN LOCK

- Locks on to 5th wheel kingpin to deter theft of 5th wheel trailer
- Universal design fits most 5th wheel trailer kingpins
- Built with an aluminum body for excellent corrosion resistance
- Two keys included for added convenience
- Space-saving, full-color retail packaging



23255 on kingpin



23255

Pkg#	Description	Finish
23255	5th wheel trailer kingpin lock	Chrome-plated

MULTI-USE CABLE LOCK

- Secures bike racks, cargo and other belongings to deter theft
- Features versatile locking and cinching capabilities
- 6' length allows for great use as a bike lock
- Constructed from 3/8" high-strength braided steel cable
- Protected by a vinyl coating for rust resistance
- Two keys included for added convenience



23666 on bike frame



23666

Pkg#	Length	Cable	Finish
23666	6'	3/8" diameter	Vinyl-coated, braided steel

SPARE TIRE LOCK

- Secures spare tires to prevent theft
- Protected by a durable chrome-plated finish
- Two keys included for added convenience



23562 exploded



23562

Pkg#	Fits	Finish
23562	Side-mount spare tires	Chrome-plated

WHEEL CHOCK LOCK

- Secures unattended trailers, RVs or vehicles by clamping onto the wheel
- Chocks and locks the wheel to prevent roll-away
- Expandable width fits most tire sizes
- Red rubber-coated arms protect the wheel's finish
- Three keys included for added convenience

Pkg#	Fits Tire Sizes		Finish
23175	4.8" - R12	215 / 70R15	Yellow powder coat with red rubber-coated arms
	7.5" - R16	225 / 75R15	
	195 / 75R14	235 / 75R15	
	205 / 60R16	235 / 80R16	
	205 / 70R15	33" x 12.5" - R15	



23175 in use



23175

WHEEL CHOCK SET

- Ideal for chocking wheels on a parked trailer
- Perfect for adding safety during vehicle maintenance
- Raised tread offers a better grip on the wheel
- Saw-tooth edges on the base provide solid traction on the ground
- Always to be used with vehicle brake
- Not for commercial use

Part#	Description
22800	For use with wheels up to 17" wide



22800 in use



22800

ANTI-RATTLE HITCH PINS

- Stops rattling and prevents swaying of load when using a hollow shank
- Compatible with CURT cargo carriers and other hollow-shank accessories
- Threaded pin allows bracket to be tightly installed

Pkg#	Fits Receiver Tube Opening	Finish
22315	1 1/4" x 1 1/4"	Yellow zinc-plated
22321	2" x 2"	Yellow zinc-plated

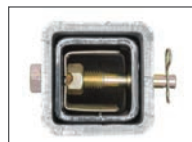

22321 in use



22315

22321

HITCH PINS & CLIPS

- Secures ball mounts and other receiver tube inserts
- Bent handle for an easier grip



Bulk#	Pkg#	Three-Pack#	Fits Receiver Tube Opening	Pin Diameter	Finish	Clip Attachment
21400	21401	--	1 1/4" x 1 1/4"	1/2"	Zinc-plated	Hole
21403	21404	--	1 1/4" x 1 1/4"	1/2"	Zinc-plated	Groove
21410	21411	--	1 1/4" x 1 1/4"	1/2"	Zinc-plated, coated grip	Hole
--	21502	--	1 1/4" x 1 1/4"	1/2"	Zinc-plated	Hole
			2" x 2"	5/8" adapter		
21500	21501	--	2" x 2"	5/8"	Zinc-plated	Hole
21504	21505	--	2" x 2"	5/8"	Zinc-plated	Groove
21510	21511	--	2" x 2"	5/8"	Zinc-plated, coated grip	Hole
21578	21579	--	2" x 2"	5/8"	Black zinc-plated	Hole
21580	21581	--	2" x 2"	5/8"	Zinc-plated	Hole
			2 1/2" x 2 1/2"			
21582	21583	--	2" x 2"	5/8"	Zinc-plated	Groove
			2 1/2" x 2 1/2"			
21507 NEW	21506 NEW	--	2 1/2" x 2 1/2"	5/8"	Zinc-plated	Groove
			3" x 3"			
21600	21601	21602	--	Fits 1/2" or 5/8"	Zinc-plated	--

SWIVEL HITCH PINS

- Quickly secures ball mounts and other receiver tube inserts with no clip needed
- Permanently attached swivel clip cannot be lost
- Bent handle for an easier grip



Pkg#	Fits Receiver Tube Opening	Pin Diameter	Finish	Description
21541	1 1/4" x 1 1/4"	1/2"	Chrome-plated	Swivel pin
23581	1 1/4" x 1 1/4"	1/2"	Stainless steel	Swivel pin
21551	2" x 2"	5/8"	Chrome-plated	Swivel pin
23582	2" x 2"	5/8"	Stainless steel	Swivel pin
21561	1 1/4" x 1 1/4"	1/2"	Zinc-plated	Swivel pin with adapter sleeve
	2" x 2"	5/8"		

SAFETY PINS

- Quickly secures coupler latches, pintle hooks, jack legs or caster wheels
- Square retainer wire clip provides added clearance
- Protected by a durable zinc-plated finish



Bulk#	Pkg#	Pin Diameter	Pin Length	Chain Length
25080	25081	1/4"	2 3/4"	--
25012	25013	1/4"	2 3/4"	12"
25010	25011	5/16"	3"	--
25034	25035	5/16"	3"	12"
28278	28279	3/8"	2 3/4"	--
28000	28001	3/8"	3"	12"



Securing a coupler latch (25034)



Securing a jack foot (28278)

FAB COMPONENTS



RAW STEEL RECEIVER TUBING

- Raw finish allows for immediate welding
- 1/2" reinforcing collar for increased strength
- Features a pre-drilled hitch pin hole



Part#	Finish	Receiver Tube Opening	Tube Length
49506	Raw	1 1/4" x 1 1/4"	6"
49512	Raw	1 1/4" x 1 1/4"	12"
49524	Raw	1 1/4" x 1 1/4"	24"
49060	Raw	2" x 2"	6"
49090	Raw	2" x 2"	9"
49120	Raw	2" x 2"	12"
49180	Raw	2" x 2"	18"
49240	Raw	2" x 2"	24"
49360	Raw	2" x 2"	36"
49480	Raw	2" x 2"	48"
49510	Raw	2 1/2" x 2 1/2"	10"



2 INCH RAW STEEL HITCH BARS

- Raw finish allows for immediate welding
- Rounded corners for easier insertion into the receiver
- Constructed from high-strength, hot-rolled steel
- Features a pre-drilled hitch pin hole



Part#	Finish	Bar Length	Description
49537	Raw	8"	Solid steel square bar
49529	Raw	10"	Solid steel square bar
49530	Raw	12"	Solid steel square bar
49531	Raw	14"	Solid steel square bar
49532	Raw	16"	Solid steel square bar
49533	Raw	18"	Solid steel square bar
49534	Raw	20"	Solid steel square bar
49535	Raw	22"	Solid steel square bar
49536	Raw	24"	Solid steel square bar



2 INCH HITCH BOX

- Raw finish for immediate welding
- Pre-drilled hitch pin hole
- High-strength steel



Part#	GTW / TW	Receiver Tube Size	Finish
49717	5,000 / 500 lbs.	2" x 2"	Raw



2 INCH REINFORCEMENT COLLAR

- Strengthens receiver tube opening
- Raw finish for immediate welding
- High-strength steel



Part#	Receiver Tube Size	Finish
49770	2" x 2"	Raw



STAKE POCKET

- Adds a tie-down for straps and chains
- Accepts 2x4 studs
- Raw finish for immediate welding



Part#	Inside Width	Inside Depth	Finish
83072	3 1/2"	1 5/8"	Raw

SAFETY CHAIN LOOP

- Provides a safety chain attachment point
- Raw finish for immediate welding



Part#	Capacity	Finish
49950	10,000 lbs.	Raw

HITCH ACCESSORIES

2 INCH FRONT MOUNT ACCESSORIES

- Fits any 2" x 2" receiver tube opening
- Designed for use with front mount hitches
- Can also be used with rear mount hitches when not towing a trailer
- Also see cargo carriers on pages 346 and 347



Part#	Description
31006	Spare tire mount (mounting hardware not included)
31001	Step pad with anti-skid surface
31002	License plate holder
31007	Skid shield
31010	Winch mount
31005	Winch mount handles
31009	Winch mount with handles



Step pad provides easy under the hood access (31001)



Provides protection for the front end and hitch (31007)



Allows a winch to be easily attached to a receiver (31009)



24" height accepts multiple tire sizes (31006)

FISH WIRE

- Makes it easier to lead bolts through tough-to-reach holes
- Ideal for installing a trailer hitch on a vehicle with a hollow frame
- Coiled end accepts threaded bolts
- Constructed from spring steel for versatile twisting and bending
- Includes one per poly bag



Part#	Length	Coil Diameter	Material
58390	18"	3/8"	Spring steel
58410	18"	7/16"	Spring steel
58400	18"	1/2"	Spring steel
58430	18"	5/8"	Spring steel

PROFESSIONAL FINISHING PACK

- Great for hitch and wiring installations
- Features 11 commonly used automotive trim panel retainers and frame hole plugs
- Contains 50 total pieces in a poly bag



Pkg#	Description
22322	50 automotive finishing pieces

1 1/4" & 2" & 2 1/2" RUBBER HITCH TUBE COVERS

- Protects 1 1/4", 2" or 2 1/2" receiver tube opening when not in use
- Adds a clean, finished look and keeps debris out
- Friction fit does not require a pin & clip to hold in place
- Features a convenient holder to mount a 4-way flat connector (#21728)

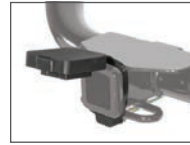

21728 in use



21728

Bulk#	Pkg#	Fits Receiver Tube Size	Finish
Rubber Hitch Tube Covers			
22271	22275	1 1/4" x 1 1/4"	Black rubber
22272	22276	2" x 2"	Black rubber
22277	22278	2 1/2" x 2 1/2"	Black rubber
Hitch Tube Cover with 4-Way Flat Holder			
--	21728	2" x 2"	Black rubber



22271 friction fit



22275

22276

22278

1 1/4" & 2" HITCH TUBE COVERS

- Protects 1 1/4" or 2" receiver tube opening when not in use
- Adds a clean, finished look and keeps debris out
- Constructed from high-strength steel (select models)
- Made from plastic to be completely rust-free (select models)
- Securely mounts using a pin and clip (not included)



22750 in use



21900



21901



22101



22111



22751

Bulk#	Pkg#	Fits Receiver Tube Size	Finish
Steel Hitch Tube Covers			
21900	21901	1 1/4" x 1 1/4"	Chrome-plated
22100	22101	2" x 2"	Chrome-plated
22110	22111	2" x 2"	Chrome-plated
22750	22751	2" x 2"	Black
Plastic Hitch Tube Covers			
22170	22171	2" x 2"	Chrome-plated
22180	22181	2" x 2"	Black



22171



22181

RV TOWING



2
INCH

ADJUSTABLE RV TRAILER HITCHES

- Three-piece, adjustable design fits multiple frame sizes
- Designed for towing a trailer or small vehicle behind an RV



13701



13702



13703

Part#	GTW / TW	WD / WDTW	Fits Frames	Drop
13701	5,000 / 500 lbs.	6,000 / 600 lbs.	Up to 51" wide	2"
13702	5,000 / 500 lbs.	6,000 / 600 lbs.	Up to 51" wide	--
13703	3,500 / 350 lbs.	--	Up to 72" wide	--

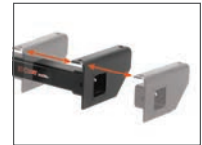

ADJUSTABLE TOW BAR

- Ideal for dingy towing a small vehicle behind an RV
- Adjusts in width from 26" to 41"
- Features a 2" heavy-duty coupler
- Lightweight design only weighs 31 lbs.
- Brackets bolt to the towed vehicle's bumper
- Universal bumper brackets and mounting hardware included



19745



19746



21500



19748



Tow bars adjust to fit different vehicles

Bulk#	Pkg#	Capacity	Ball Diameter	Finish	Dimensions	Description
--	19745	5,000 lbs.	2"	Gloss black	Adjusts from 26" to 41" in width	Adjustable tow bar
19746	--	--	--	Zinc-plated	1/2" diameter / 3" length	Replacement safety pin (new style)
21500	21501	--	--	Zinc-plated	5/8" diameter	Replacement pin & clip (old style)
19748	--	--	--	Gloss black	--	Bumper brackets



RV HARNESSSES

- Connects a towed vehicle to an RV using a standard 4-way flat trailer plug
- Simple plug-and-play design eliminates the need for cutting or splicing
- Integrated block diodes isolate sensitive vehicle electronics from RV signals
- Uses towed vehicle's existing taillights, brake lights and turn signals
- Includes harness, 4-flat extension, mounting bracket and hardware
- See page 252 for application guide

NEW



TOWING LIGHTS

- Easily adds tow lights to a vehicle being dinghy towed
- Non-scratch magnetic base protects vehicle finish
- Perfect for boats, RVs and flat towing applications
- 20' cord with 4-way flat plug allows for plug-and-play convenience
- Snap locks included for simple, secure splice-in connection
- Patent# D355,270



Bulk#	Pkg#	Length	Plug	Description
53200	53204*	20'	4-way flat	Auxiliary towing lights

* Includes a sturdy, reusable case

EXTENDED VIEW TOW MIRROR

- Attaches to side mirror to expand view with a trailer
- Compatible with pickup or SUV left or right side mirror
- Fully adjustable design can be used in horizontal or vertical position
- Articulating head allows precise angling
- Hinging arm and elastic straps provide easy and secure installation



Pkg#	Mirror Dimensions	Description
20002	Extends from 5" to 7 1/2"	Tow mirror for trucks and SUVs



TOWING ELECTRICAL

EMPOWERING THEIR PASSION

Get your customers plugged in with CURT electrical. New for 2018, we are introducing a complete line of vehicle-specific RV harnesses for dinghy towing. We have also added several new custom wiring harnesses with watertight potted enclosures, two new brake controls and three new heavy-duty 7-way connectors. CURT electrical products are fully supported by our online and in-print product guides, detailed installation instructions and our knowledgeable Product Support team ready to take your call.

FEATURED PRODUCTS



Spectrum™ brake control

The interface of this innovative control is a simple rotary knob, while the main module installs behind the dash, completely out of view.



Assure™ brake control

This new inertia-based control features a high-quality 128 x 64 dot matrix OLED display and a tri-axis accelerometer for smooth stops.



RV towing harnesses

Designed for vehicle-specific application, CURT RV harnesses make towing a vehicle behind an RV simple and safe.

PRODUCT INDEX



237
Brake Controls



241
Brake Control Harnesses



244
Breakaway Kits



246
Custom Wiring



246
USCAR Products



250
Wiring Harness Extensions



252
RV Harnesses



254
Taillight Converters



256
Electrical Adapters



261
Plugs, Sockets & Brackets



268
Towing Lights



269
Accessories & Testers

TOWING ELECTRICAL SUBCATEGORY COLOR GUIDE

CURT has identified seven subcategories within the towing electrical category to make it easier for retail customers to find the correct products. Each sub-category is given a unique color that we apply in our literature and retail packaging for easy visibility.



ELECTRICAL CONNECTOR WIRING GUIDE

- Rear views of plugs & sockets shown in the representative illustrations below
- Colors illustrated may not represent the colors found on the tow vehicle or trailer
- For more information on connector types see page 11

7-way RV blade traditional configuration

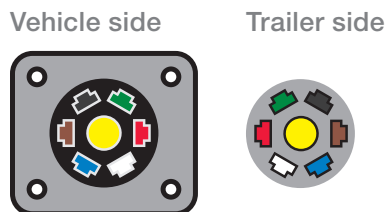

Function	Color
+12 volt	Black
Electric brakes	Blue
Reverse lights	Yellow
Left turn / brakes	Red
Right turn / brakes	Brown
Taillights	Green
Ground	White

6-way round

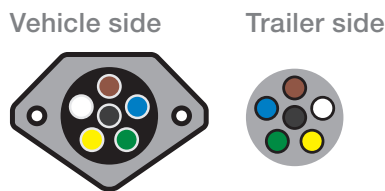

Function	Color
+12 volt	Black
Electric brakes	Blue
Left turn / brakes	Yellow
Right turn / brakes	Green
Taillights	Brown
Ground	White

4-way flat



Function	Color
Left turn / brakes	Yellow
Right turn / brakes	Green
Taillights	Brown
Ground	White

WIRING SYSTEMS

Two-wire system

The two-wire system is the simplest form of vehicle and trailer wiring and is still used by some vehicles today. This system sends the stop and turn signals along one wire, and the taillight signal along a second wire.

Three-wire system

The three-wire system is the most common in the automotive industry. It sends the stop, taillight and turn signals along three separate wires. Vehicles with a this system usually require a converter.

PWM system

More and more vehicles today use a PWM (pulse width modulation) system. Sometimes called a 'multiplex', this type of wiring is able to control multiple lighting functions through a single wire by varying the signal intensity. PWM systems can use incandescent or LED lights. There are generally two types: ST systems and STT systems.

See page 10 for more details

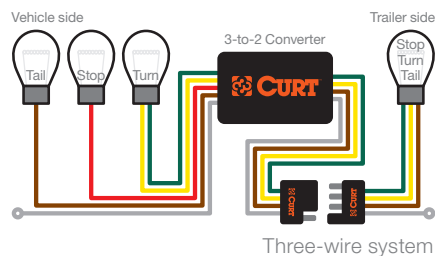

HOW TO SELECT A BRAKE CONTROL



Spectrum™



Assure™



TriFlex™



Reflex™



Discovery™



Venturer™

A brake control is a small electronic device that regulates the electric brakes of a trailer from the cab of the tow vehicle and allows the driver to activate and monitor trailer brake activity. There are two basic types of brake controls: inertia-based and time-based. Each type is classified by the method of activation the brake control uses.

Inertia-based activation

Inertia-based brake controls use accelerometers to measure the change in velocity or inertia of the tow vehicle when braking. The advantage of inertia-based activation is that once calibrated, the control can output the perfect amount of power needed to come to a smooth stop in any towing situation.

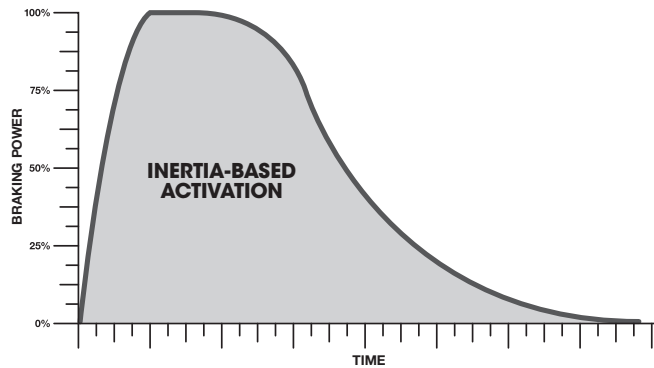

Time-based activation

Time-based brake controls apply a steadily increasing amount of brake power, based on the gain setting and sensitivity adjustment specified by the driver. Although they are effective and simple to use, time-based brake controls are generally not as precise as inertia-based brake controls.

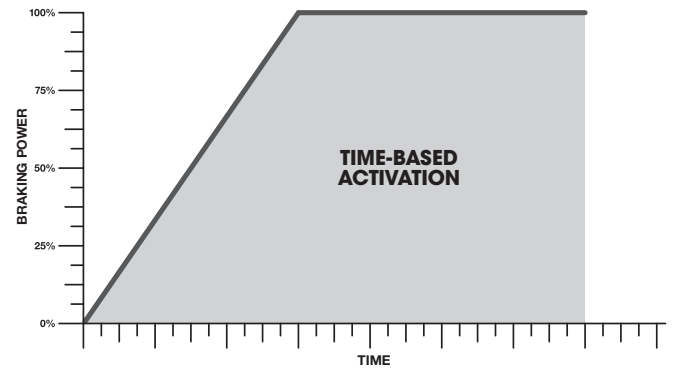

There are several factors to consider when selecting a brake control.

Answer the following questions to help determine which brake control is the best fit for your customer.

What are they towing?

Heavy-duty

If your customer is planning to tow heavy or fragile cargo, an inertia-based brake control is ideal. Inertia-based controls perform much smoother stops, resulting in less stress on the cargo and on the vehicle.

Light-duty

If your customer is planning to tow a relatively lightweight trailer, a time-based brake control may be sufficient. CURT's time-based controls are more budget-friendly and perform well with lighter loads.

How often do they tow?

Frequently

If your customer is planning to tow frequently or commercially, an inertia-based brake control is recommended. The precision of this type of control will help protect the life of the vehicle and trailer.

Occasionally

If your customer will only tow a few times a year, they may prefer the simplicity and relatively lower cost of a time-based control. Time-based controls also require very little effort to set up.

BRAKE CONTROLS

BRAKE CONTROLS

- Equipped with quick plugs for fast, easy installation
- Easily calibrated for all towing needs
- Compatible with anti-lock brakes and cruise control
- Includes mounting hardware
- Optional spare bracket allows for convenient use of the same brake control in multiple vehicles
- Informative, full-color retail packaging

QUICK PLUG EQUIPPED

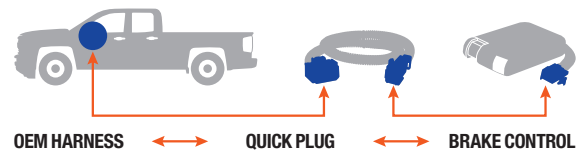

Dynamic power adjustment

Applies to Spectrum™, Assure™ and TriFlex™



4.0 User input power adjustment setting



4.0 → **3.2** Automatic power reduction for incline



4.0 → **5.3** Automatic power increase for decline

Note: Values represented are for illustration only. The actual preset and adaptive values may differ from those shown here.

Name	Retail Pkg#	Six-Pack#	Repl. Bracket#	Axles / Brakes	Activation Method	Display	Vertical Mount Angle	Level Adjust	Warranty
Spectrum™	51170 NEW	--	--	1 - 4 / 2 - 8	Tri-axis inertia	Tri-color LED	Any	Auto	Limited Lifetime
Assure™	51160 NEW	--	--	1 - 4 / 2 - 8	Tri-axis inertia	Dot matrix	Any	Auto	Limited Lifetime
TriFlex™	51140	51142	51144	1 - 4 / 2 - 8	Tri-axis inertia	Digital	-20° to +70°	Auto	Limited Lifetime
Relfex™	51130	51132	--	1 - 4 / 2 - 8	Dual-axis inertia	Digital	Any	Auto	Limited Lifetime
Venturer™	51120	51122	51124	1 - 4 / 2 - 8	Time-based	Digital	Any	Auto	Limited Lifetime
Discovery™	51110	--	51114	1 - 3 / 2 - 6	Time-based	LED	Any	Auto	Limited Lifetime

BRAKE CONTROLS

SPECTRUM™ BRAKE CONTROL

- Main module can be mounted anywhere, at any orientation, out of sight
- Separate user interface with 10 red, green and blue LEDs for sleek, clean, in-dash mounting
- Single rotary encoder knob with built-in push-button to control all settings
- Triple-axis, motion-sensing accelerometer for highly responsive, smooth stops
- Includes two mounting brackets for drill mount or surface adhesive mount
- User-selectable output and brake light activation
- Built-in dual-polarity and short-circuit protection
- Compatible with low voltage or PWM systems
- Tow vehicle 'low voltage' and trailer disconnect indicators



51170

NEW

Modes and indicators



Calibration (Ramp-up)



Overloaded (Flashing)



Disconnected (Flashing)



Manual



Brightness



Max Output



Aggressiveness

**BRAKE
CONTROLS**

ASSURE™ BRAKE CONTROL

- Pressure-sensitive manual override button for precise braking power
- High-quality 128 x 64 dot matrix OLED screen display
- Display can be tilted for different mounting options, above or below the dash
- Triple-axis, motion-sensing accelerometer for highly responsive, smooth stops
- Sleek, low-profile design with tactile buttons
- User-selectable power output and trailer brake light activation
- Nine levels of sensitivity adjustment for varying loads or driving conditions
- Auto sleep mode prevents battery drain
- Built-in dual-polarity and short-circuit protection
- Compatible with low voltage or PWM systems
- Tow vehicle 'low voltage' and trailer disconnect indicators

NEW



51160

**BRAKE
CONTROLS**

TRIFLEX™ BRAKE CONTROL

- Triple-axis, motion-sensing accelerometer for highly responsive, smooth stops
- Nine levels of sensitivity adjustment for varying loads or driving conditions
- User-selectable power output and trailer brake light activation
- Digital display with 0.1 increments
- Built-in dual-polarity and short-circuit protection
- Tow vehicle 'low voltage' and trailer disconnect indicators
- Compatible with low voltage or PWM systems
- Compact size: 3 1/4" wide, 4" deep, 7/8" tall



51140

**BRAKE
CONTROLS**

REFLEX™ BRAKE CONTROL



- Dual-axis, motion-sensing accelerometer for smooth stops
- Automatically adjusts brake output when going up or down a hill
- Adjustable power output allows use with multiple load sizes
- Digital display with 0.1 increments



51130

**BRAKE
CONTROLS**

DISCOVERY™ & VENTURER™ BRAKE CONTROLS

- Increases brake power based on gain setting and sensitivity adjustment
- Features fully adjustable power and ramp time
- No internal moving parts and no leveling required



51120

Digital display with 0.1 increments



51110

LED indicator lengthens as controller applies power

**BRAKE
CONTROLS**

COMPETITOR-TO-CURT ADAPTER

- Allows CURT brake controls to be used with Tekonsha, Reese, Draw-Tite or Pro Series vehicle-specific brake control harnesses

Pkg#	Description
51520	Connects CURT brake controls to competitor harnesses

The brands listed above are registered trademarks of Cequent Consumer Products™



**BRAKE
CONTROLS**

QUICK PLUG WITH PIGTAILS

- For vehicles not equipped with factory tow package wiring
- Splices into a vehicle for a quick plug brake control connection
- Compatible with any CURT brake control

Bulk#	Pkg#	Description
51515	51516	Quick plug with 24" pigtails



**BRAKE
CONTROLS**

UNIVERSAL BRAKE CONTROL WIRING KIT

- For vehicles not equipped with factory tow package wiring
- Compatible with 2, 4, 6 or 8-brake systems (1 - 4 axles)
- Brake control and trailer connector are not included



Pkg#	Includes							
51500	Duplex wire, 10 gauge Length: 10 feet	Cross-linked wire, 10 gauge Length: 20 feet	Circuit breaker, 30-amp	3/8" ring terminals, 12-10 gauge Qty: 2	10 ring terminals, 12-10 gauge Qty: 2	1/2" ring terminals, 12-10 gauge Qty: 2	Butt connectors, 12-10 gauge Qty: 3	Cable ties, 8 1/2" Qty: 8

Designed for use with 51515 / 51516 quick plug with pigtails, shown above

BRAKE CONTROL HARNESS APPLICATION GUIDE

- Quick plug harness installs in less than ten minutes
- Connects any CURT brake control to specific vehicle applications
- Includes 24" of 12-gauge wire for flexible installation
- Slit-loom sleeve keeps wires contained and protected



Make / Model	Style	Years	Foot Note	Bulk#	Pkg#	Loc.
Buick						
Enclave	--	08 - 17	--	51422	51423	BH1
Cadillac						
Escalade	--	14 - 17	--	51451	51452	BH3
		03 - 06	--	51352	51353	BH3
		02 - 02	--	51342	51343	BH3
Escalade ESV	--	14 - 16	--	51451	51452	BH3
Chevrolet						
Avalanche	--	03 - 06	--	51352	51353	BH3
		02 - 02	--	51342	51343	BH3
Silverado 1500	Custom	16 - 18	--	51451	51452	BH1
	High Country	14 - 18	--	51451	51452	BH1
	LS	15 - 18	--	51451	51452	BH1
	LT & LTZ	14 - 18	--	51451	51452	BH1
	SSV	15 - 18	--	51451	51452	BH1
	WT	14 - 17	--	51451	51452	BH1
	--	07 - 13	1, 4	See footnotes		
--	07 - 07	5	51352	51353	BH3	
--	03 - 06	--	51352	51353	BH3	
--	99 - 02	--	51342	51343	BH3	
Silverado 2500	--	03 - 06	--	51352	51353	BH3
		99 - 02	--	51342	51343	BH3
Silverado 2500 HD	High Country	15 - 18	--	51451	51452	BH1
	LT & LTZ	14 - 18	--	51451	51452	BH1
	WT	14 - 18	--	51451	51452	BH1
	--	07 - 13	1, 4	See footnotes		
	--	2007	5	51352	51353	BH3
	--	03 - 06	--	51352	51353	BH3
	--	01 - 02	--	51342	51343	BH3
Silverado 3500	--	03 - 06	--	51352	51353	BH3
		01 - 02	--	51342	51343	BH3
Silverado 3500 HD	High Country	15 - 18	--	51451	51452	BH1
	LT & LTZ	14 - 18	--	51451	51452	BH1
	WT	14 - 18	--	51451	51452	BH1
	--	07 - 13	1, 4	See footnotes		
	--	07 - 07	5	51352	51353	BH3
Suburban	--	15 - 17	--	51451	51452	BH3
Suburban 1500	--	15 - 16	--	51451	51452	BH3
		03 - 06	--	51352	51353	BH3
		00 - 02	--	51342	51343	BH3

Make / Model	Style	Years	Foot Note	Bulk#	Pkg#	Loc.
Chevrolet (continued)						
Suburban 2500	--	03 - 06	--	51352	51353	BH3
		00 - 02	--	51342	51343	BH3
Suburban 3500 HD	--	16 - 16	--	51451	51452	BH3
Tahoe	--	15 - 17	--	51451	51452	BH3
		03 - 06	--	51352	51353	BH3
		00 - 02	7	51342	51343	BH3
Traverse	--	09 - 17	2	51422	51423	BH3
Chrysler						
Aspen	--	07 - 09	2	51332	51333	BH1
Dodge						
Dakota	--	97 - 11	2	51332	51333	BH1
Durango	--	11 - 17	2	51446	51447	BH8
		98 - 09	--	51332	51333	BH1
Ram 1500 / 2500 / 3500	--	10 - 10	--	51438	51439	BH8
Ram Pickup	--	95 - 09	--	51332	51333	BH1
Ford						
Bronco	--	94 - 96	6	51322	51323	BH2
		92 - 93	6	51312	51313	BH1
E-150	--	09 - 14	--	51432	51433	BH5
		92 - 08	--	51322	51323	BH1
E-250	--	09 - 14	--	51432	51433	BH5
		92 - 08	--	51322	51323	BH1
E-350 / E-450 Super Duty	--	09 - 14	--	51432	51433	BH5
		92 - 08	--	51322	51323	BH1
Excursion	--	00 - 05	--	51322	51323	BH2
Expedition	--	13 - 17	--	51432	51433	BH5
		97 - 12	--	51322	51323	BH2
Explorer	--	02 - 16	2	51322	51323	BH2
F-150	--	09 - 17	--	51436	51437	BH7
		04 - 08	4	51322	51323	BH2
	Heritage Edition	--	04 - 04	--	51322	51323
F-150 / F-250 Light Duty	--	94 - 03	--	51322	51323	BH2

1. Not equipped with a brake control harness. Hardwire #51515 to blunt-cut wires under dash.
2. With factory tow package
3. Without factory trailer brakes
4. New body
5. Classic body
6. Full size
7. New body with amber turn signals

Applications continued on the following page

Make / Model	Style	Years	Foot Note	Bulk#	Pkg#	Loc.
Ford (continued)						
F-250 / F-350 Super Duty	--	17 - 17	3	51436	51437	BH5
		08 - 16	--	51432	51433	BH5
		05 - 07	--	51372	51373	BH4
		99 - 04	--	51322	51323	BH2
F-250 HD / F-350 HD	--	97 - 97	--	51322	51323	BH2
F-150 / F-250 / F-350	--	94 - 96	--	51322	51323	BH2
F-Series	--	92 - 93	6	51312	51313	BH1
F-450 / F-550 Super Duty	--	08 - 16	--	51432	51433	BH5
		05 - 07	--	51372	51373	BH4
Flex	--	12 - 15	2	51436	51437	BH7
		09 - 11	--	51322	51323	BH2
Windstar	--	95 - 03	2	51322	51323	BH2
GMC						
Acadia	Denali	11 - 18	--	51422	51423	BH1
	SL	16 - 18	--	51422	51423	BH1
		10 - 13	--	51422	51423	BH1
	SLE & SLT	07 - 18	--	51422	51423	BH1
	Limited	17 - 17	--	51422	51423	BH1
Sierra 1500	Base	14 - 18	--	51451	51452	BH1
	Denali	14 - 18	--	51451	51452	BH1
	SLE & SLT	14 - 18	--	51451	51452	BH1
	--	07 - 13	1, 4	See footnotes		
		07 - 07	5	51352	51353	BH3
		03 - 06	--	51352	51353	BH3
		99 - 02	--	51342	51343	BH3
Sierra 2500	--	03 - 06	--	51352	51353	BH3
		99 - 02	--	51342	51343	BH3
Sierra 2500 HD	Base	15 - 18	--	51451	51452	BH1
	Denali	14 - 18	--	51451	51452	BH1
	SLE & SLT	14 - 18	--	51451	51452	BH1
	WT	14 - 14	--	51451	51452	BH1
	--	07 - 13	1, 4	See footnotes		
		07 - 07	5	51352	51353	BH3
		03 - 06	--	51352	51353	BH3
		01 - 02	--	51342	51343	BH3
Sierra 3500	Base	15 - 18	--	51352	51353	BH3
	Denali	14 - 18	--	51352	51353	BH3
	SLE & SLT	14 - 18	--	51352	51353	BH3
	WT	14 - 14	--	51352	51353	BH3
	--	01 - 02	--	51342	51343	BH3
Sierra 3500 HD	--	14 - 17	--	51451	51452	BH1
		07 - 13	1, 4	See footnotes		
		07 - 07	5	51352	51353	BH3

Make / Model	Style	Years	Foot Note	Bulk#	Pkg#	Loc.
GMC (continued)						
Yukon	--	15 - 17	--	51451	51452	BH3
Yukon XL	--	15 - 17	--	51451	51452	BH3
		03 - 06	--	51352	51353	BH3
		00 - 02	7	51342	51343	BH3
Honda						
Pilot	--	06 - 16	--	51392	51393	BH1
Ridgeline	--	17 - 17	--	51392	51393	BH1
		06 - 14	--	51392	51393	BH1
Hummer						
H2	--	03 - 07	--	51352	51353	BH3
Infiniti						
QX56	--	04 - 13	--	51382	51383	BH1
QX60	Base	14 - 17	--	51382	51383	BH1
	Hybrid	14 - 14	--	51382	51383	BH1
QX80	--	14 - 17	--	51382	51383	BH1
Jeep						
Cherokee	--	14 - 16	--	51459	51460	BH1
Grand Cherokee	75th Anni.	16 - 16	--	51446	51447	BH8
	Laredo	11 - 18	--	51446	51447	BH8
	Limited	11 - 18	--	51446	51447	BH8
	Overland	11 - 18	--	51446	51447	BH8
	Overland Summit	12 - 12	--	51446	51447	BH8
	SRT	14 - 18	--	51446	51447	BH8
	SRT8	12 - 13	--	51446	51447	BH8
	Summit	14 - 18	--	51446	51447	BH8
	Trackhawk	18 - 18	--	51446	51447	BH8
	Trailhawk	14 - 18	--	51446	51447	BH8
Kia						
Borrego	--	09 - 11	--	51442	51443	BH1
Land Rover						
LR3	--	05 - 09	--	51322	51323	BH2
LR4	--	10 - 15	--	51322	51323	BH2
Range Rover	Incl. Sport	05 - 15	--	51322	51323	BH2
Range Rover Evoque	--	12 - 16	--	51322	51323	BH2
Lexus						
GX460	--	10 - 15	--	51362	51363	BH1
GX470	--	03 - 11	--	51362	51363	BH1
LX470	--	03 - 07	--	51362	51363	BH1
LX570	--	13 - 15	--	51362	51363	BH1
		08 - 11	--	51362	51363	BH1

- Not equipped with a brake control harness. Hardwire #51515 to blunt-cut wires under dash.
- With factory tow package
- Without factory trailer brakes
- New body
- Classic body
- Full size
- New body with amber turn signals

Applications continued on the following page

Make / Model	Style	Years	Foot Note	Bulk#	Pkg#	Loc.
Lincoln						
Mark LT	--	06 - 08	--	51322	51323	BH2
MKT	--	12 - 15	2	51436	51437	BH7
		10 - 11	--	51322	51323	BH2
Navigator	--	13 - 17	--	51432	51433	BH5
		98 - 12	--	51322	51323	BH2
Mercury						
Mountaineer	--	02 - 10	2	51322	51323	BH2
Nissan						
Armada	--	17 - 17	--	51382	51383	BH1
		04 - 15	--	51382	51383	BH1
Frontier	--	05 - 17	--	51382	51383	BH1
NV200	--	13 - 17	--	51382	51383	BH1
NV1500	--	12 - 17	--	51382	51383	BH1
NV3500	--	12 - 17	--	51382	51383	BH1
Pathfinder	--	04 - 17	--	51382	51383	BH1
Pathfinder Armada	--	04 - 04	--	51382	51383	BH1
Titan	--	04 - 15	--	51382	51383	BH1
Titan XD	--	16 - 16	--	51382	51383	BH1
Xterra	--	05 - 15	--	51382	51383	BH1

Make / Model	Style	Years	Foot Note	Bulk#	Pkg#	Loc.
Ram						
1500 / 2500 / 3500	--	15 - 17	--	51457	51458	BH2
		13 - 14	--	--	51453	BH8
		11 - 12	--	51438	51439	BH8
4500 / 5500	--	16 - 17	--	51457	51458	BH2
Saturn						
Outlook	--	07 - 09	--	51422	51423	BH1
Toyota						
4Runner	Limited, SR5 & TRD Pro	17 - 17	--	51362	51363	BH1
		--	03 - 16	--	51362	51363
Land Cruiser	--	13 - 17	--	51362	51363	BH1
		03 - 11	--	51362	51363	BH1
Sequoia	--	03 - 17	--	51362	51363	BH1
Tacoma	--	16 - 17	--	51455	51456	BH4
		07 - 15	--	51362	51363	BH1
Tundra	--	15 - 17	--	51455	51456	BH4
		03 - 14	--	51362	51363	BH1

1. Not equipped with a brake control harness. Hardwire #51515 to blunt-cut wires under dash.
2. With factory tow package
3. Without factory trailer brakes
4. New body
5. Classic body
6. Full size
7. New body with amber turn signals

Brake control harness locations

- BH1** - Under dash, left of steering column, near emergency brake pedal
- BH2** - Under dash, near center console
- BH3** - Under dash, in junction box left of steering column
- BH4** - Behind storage pocket, above ashtray

- BH5** - Under dash, behind center access panel on passenger side
- BH6** - Under dash, near brake pedal
- BH7** - Behind storage pocket in center of dash
- BH8** - Under dash, to right of emergency brake pedal

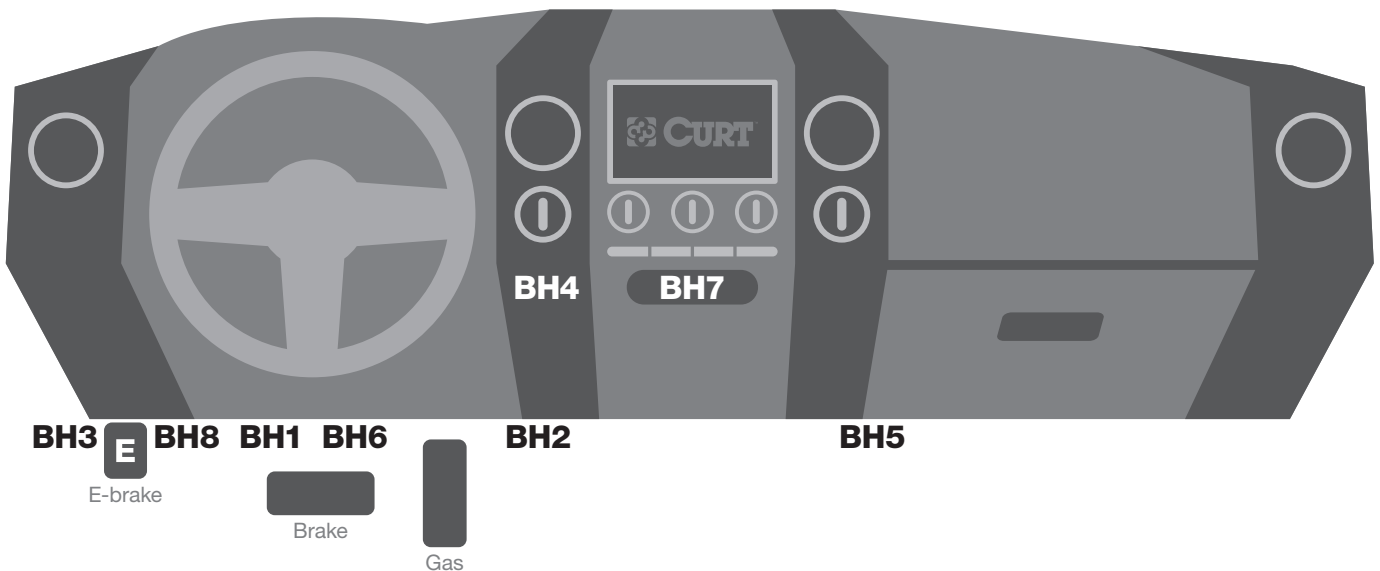

Check to ensure battery is charged before towing

- Activates electric trailer brakes in the event of a breakaway
- Meets DOT requirements for holding / breakaway situations
- Compatible with trailers with up to three axles
- LED lights indicate a good charge, battery charging or low battery (#52042, #52044)
- Bolt-on mounting system for secure installation on the trailer
- Required in most states



52044



52042



52040



52028

Pkg#	Loads From	Includes	Replacement Part#
Push-to-Test Breakaway Kits			
52044	Top	Push-to-test battery case	--
		12-volt 5-amp rechargeable battery	52023
		Built-in battery charger	52025
		Nylon breakaway switch	52010
		Mounting hardware	--
52042	Side	Includes the same parts as 52044	--
Soft-Trac 1 Breakaway Kits			
52040	Side	Lockable battery case	52027
		12-volt 5-amp rechargeable battery	52023
		Nylon breakaway switch	52010
		Battery charger	52025
		Mounting hardware	--
52041	Side	Includes the same parts as 52040 Battery charger not included	--
Soft-Trac 2 Breakaway Kits			
52028	Top	Battery case with mounting bracket	52029
		12-volt 5-amp rechargeable battery	52023
		Nylon breakaway switch	52010
		Battery charger	52025
52026	Top	Includes the same parts as 52028 Battery charger not included	--



52042 push-to-test, side load



52044 push-to-test, top load

**BRAKE
CONTROLS**

REPLACEMENT BATTERY CASES

- Protects battery and charger from the elements and corrosion
- Constructed from durable polyethylene plastic



52022



52090



52029



52027



52030

Bulk#	Width	Height	Depth	Description	Loads From	Includes
52029	5"	3 1/4"	3 7/8"	3 1/8" inside bracket depth	Top	Weldable metal bracket for easy mounting on A-frame or jack posts
52030	5"	3 1/4"	3 7/8"	--	Side	--
52027	5"	3 3/8"	3 3/4"	Watertight case with rubber gaskets and screw-tight lid	Top	Four-screw lid
52022	6"	5 1/2"	3 1/4"	--	Top	Lockable tab and a bolt-on mount
52090	5 7/8"	5 3/8"	3 1/2"	--	Top	Metal bracket and locking bar for security

**BRAKE
CONTROLS**

BREAKAWAY KIT REPLACEMENT PARTS

- For use with trailer breakaway systems
- Connects tow vehicle to trailer breakaway battery (#52010, #52011)
- Features a high-temp metal mounting tab and nylon pull-pin (#52020)



52023



52025



52010



52011



52020

Bulk#	Pkg#	Width	Height	Depth	Description	Includes
52010	52011	--	--	--	Breakaway switch with 10' leads	Nylon case with weldable high-temp, metal tab and silver contact points
52020	--	--	--	--	48" lanyard	--
52023	--	3 1/2"	4"	2 3/4"	Sealed lead acid battery for 1-3 axle trailers (12-volt, 5 amps per hour)	--
52025	--	--	--	--	12-volt battery charger	--

To find custom wiring for a specific vehicle, turn to the CURT Application Guide on page 32.

Two Types of Custom Wiring Products

Harnesses

A custom wiring harness (also called a T-connector) is a plug-and-play electrical device that provides a vehicle with a standard trailer wiring output, usually in the form of a 4-way flat. It uses vehicle-specific plugs to 'T' into the vehicle's taillight assembly, eliminating the need for cutting, splicing and soldering when installing vehicle-to-trailer wiring.

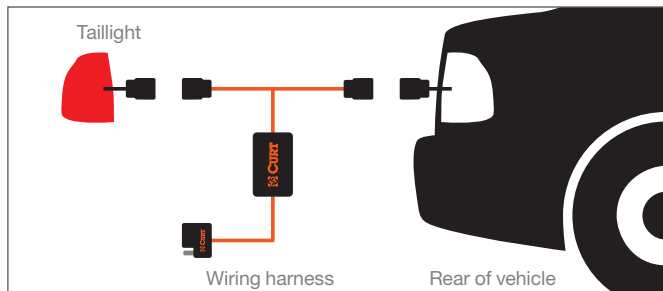

Custom wiring harnesses use multiple plugs to 'T' into the taillight assembly

Connectors

In some cases, while a vehicle may not be equipped with a standard wiring output for towing, it will have an original equipment socket that is specifically intended for hooking up trailer wiring. A CURT custom wiring connector is designed to use this OE socket. Like a custom wiring harness, no cutting, splicing or soldering is required.

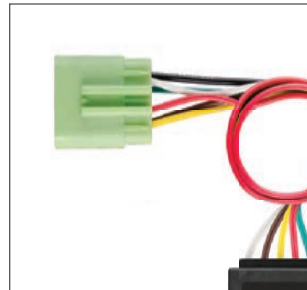

Custom wiring connectors use a single plug to plug into a specific OEM socket

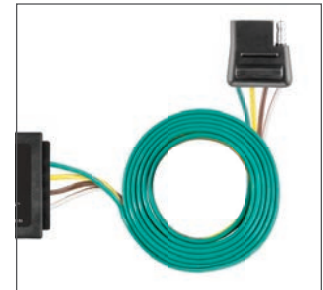

Harnesses and connectors both provide a standard trailer wiring connector, typically a 4-way flat

DODGE FACTORY HARNESS ADAPTER

- Adapts Dodge harness applications to fit USCAR replacement plugs (pictured right)
- Simple plug-and-play design eliminates the need for cutting or splicing
- Slit loom keeps wires contained and well protected
- See application guide below for a custom fit



Provides this USCAR socket

Make / Model	Years
Chrysler	
Aspen	07 - 08
Pacifica	04 - 08
Dodge	
Dakota	00 - 10
Durango	00 - 08
Ram 1500	00 - 08
Ram 2500 / 3500	00 - 09
Ram van 1500 / 2500 / 3500	01 - 03
Sprinter 2500 / 3500	03 - 09

Make / Model	Years
Freightliner	
Sprinter 2500 / 3500	03 - 09
Jeep	
Commander	06 - 10
Grand Cherokee	00 - 10
Liberty	05 - 08
Mitsubishi	
Raider	06 - 09



57300

CUSTOM WIRING

REPLACEMENT USCAR SOCKET

- Replaces damaged or missing USCAR vehicle harnesses
- Retrofits weatherproof USCAR-type 7-way to vehicles not equipped by using CURT part numbers 55415, 55515, 55664, 55774, 56514, 56515 or 57101

Pkg#	Length	Replaces	Provides
56229	24" wires	Existing vehicle harness connector	USCAR connector end



CUSTOM WIRING

ELECTRICAL ADAPTERS

DUAL-OUTPUT ADAPTERS WITH BACKUP ALARM

- Integrated backup alarm sounds when vehicle is in reverse (97 decibels)
- Provides a 7-way RV blade and 4-way flat
- Dust covers included to keep connectors clean when not in use
- Metal bracket securely mounts wiring to the vehicle or trailer hitch



57100 8-prong plug



Plugs into USCAR



Pkg#	Fits	Plugs Into	Output
Custom Wiring			
57100	Dodge, Chrysler, Jeep	Factory rectangular 8-prong	7-way RV blade and 4-way flat
57101	See USCAR replacement products on page 248	USCAR socket	7-way RV blade and 4-way flat
Adapter			
57102	Universal adapter	4-way flat, manual wiring needed	7-way RV blade and 4-way flat

USCAR CUSTOM WIRING HARNESSES & CONNECTORS

- Products listed fit the applications in the table on page 249
- Fits USCAR-equipped vehicles with factory tow plugs (shown below)
- See page 267 for USCAR mounting bracket #58520
- Weather-resistant dust cover features a rubber insert to seal out moisture (#55416)



All plug into this USCAR socket



55664



55774



57101

NEW



55416



55415



56415



55515



56515



55384



56584

Pkg#	Plugs Into	Provides	Output
55664	USCAR socket	Two output connections	6-way round and 4-way flat
55774	USCAR socket	Two output connections	7-way RV blade and 4-way flat
55515	USCAR socket	Replacement end	4-way flat
56515	USCAR socket	Replacement end	5-way flat
55384	T's into USCAR socket	Additional connection	Additional 4-way flat
56584	T's into USCAR socket	Additional connection	Additional 5-way flat
57101	USCAR socket	Two output connections and backup alarm (97 decibels)	7-way RV blade and 4-way flat
55416 NEW	USCAR socket	Heavy-duty replacement for Ford, GM and Nissan vehicles	7-way RV blade
55415	USCAR socket	Replacement for Ford, GM and Nissan vehicles	7-way RV blade
56415	USCAR socket	Replacement for twist-lock brackets	7-way RV blade

USCAR CUSTOM WIRING APPLICATION GUIDE

Make / Model	Style / Notes	Years
Audi		
Q7	--	17 - 17
Buick		
Enclave	--	08 - 17
Rainier	--	04 - 07
Cadillac		
Escalade	Including Hybrid	02 - 17
Escalade ESV	--	03 - 17
Escalade EXT	--	02 - 13
XT5	--	17 - 18
Chevrolet / GMC		
Acadia	Limited	17 - 17
Acadia	--	07 - 18
Avalanche	--	02 - 13
Colorado / Canyon	--	15 - 17 04 - 12
Envoy	--	02 - 09
Express / Savana	--	09 - 09
Express / Savana 3500	Cutaway	17 - 17
Silverado / Sierra	Including Hybrid, WT	99 - 18
Sierra	Hybrid	09 - 17
Suburban	Including Hybrid	00 - 17
Tahoe	Including Hybrid	00 - 17
Terrain	--	18 - 18
Trailblazer	--	02 - 09
Traverse	--	09 - 17
Yukon	Including Hybrid	00 - 17
Yukon XL	--	00 - 17
Chrysler		
Aspen	Starting late built 07 models	07 - 09
Dodge		
Durango	Starting late built 07 models	07 - 11
Durango	Excluding #55384	12 - 15
Ram 1500	--	09 - 10
Ram 2500 / 3500	--	10 - 10
Ford		
Econoline Van	--	97 - 10
Excursion	--	00 - 05
Expedition	--	97 - 17
Explorer	--	00 - 17
Explorer Sport Trac	--	09 - 09
F-150	--	97 - 18
F-250 Light Duty	--	97 - 99
F-250 / F-350 Super Duty	--	99 - 17
F-450 / F-550 Super Duty	May need CURT #56229	99 - 17
Flex	--	09 - 16
Ranger	--	00 - 11
Transit 150 / 250 / 350	Cargo and passenger	15 - 17

Make / Model	Style / Notes	Years
Hummer		
H2	--	03 - 09
H3	--	06 - 10
H3T	--	09 - 10
Infiniti		
QX56	--	04 - 13
QX60	--	14 - 17
QX80	--	14 - 17
Isuzu		
Ascender	--	03 - 08
Kia		
Borrego	--	09 - 11
Jeep		
Grand Cherokee	Excluding #55384	11 - 18
Lincoln		
Aviator	--	03 - 05
Mark LT	--	06 - 08
Navigator	--	98 - 17
Mercury		
Mountaineer	--	02 - 10
Nissan		
Armada	--	17 - 17
Armada	--	05 - 15
Pathfinder	--	05 - 17
Pathfinder Armada	--	04 - 04
Titan / Titan XD	--	04 - 17
Oldsmobile		
Bravada	--	02 - 04
Ram		
1500	--	11 - 17
2500 / 3500	--	11 - 17
3500 / 4500 / 5500	Chassis Cab	11 - 17
ProMaster	--	14 - 17
ProMaster	Chassis Cab	17 - 17
ProMaster	Cutaway	17 - 17
Saab		
9-7X	--	05 - 09
Saturn		
Outlook	--	07 - 10
Toyota		
4Runner	--	15 - 17
Sequoia	--	12 - 17
Tundra	--	10 - 18

CUSTOM WIRING HARNESS EXTENSIONS

- Routes a 7-way RV blade socket into truck bed while retaining use of rear socket
- Simple plug-and-play design eliminates the need for cutting or splicing
- Allows for easy connection of 5th wheel or gooseneck wiring
- Right-angle plug for easy installation
- Spring-loaded dust cover keeps connector clean when not in use
- Slit loom protects and contains wires



7' routes socket into rear of the truck bed



10' routes socket closer to truck cab



Right-angle plug for easy installation



56070 (7')
56000 (10')



56071 (7')
56001 (10')



Make / Model	Years	7' Pkg#	7' Bulk 10-Pack#	10' Pkg#	10' Bulk 10-Pack#
Chevrolet / GMC					
Silverado / Sierra	99 - 18	56070	56070010	56000	56000010
Dodge					
Dakota	95 - 10	56071	--	56001	--
Ram 1500 / 2500 / 3500	09 - 10	56070	56070010	56000	56000010
	95 - 08	56071	--	56001	--
Ford					
F-150	15 - 18	57008*	--	57010*	--
	97 - 14	56070	56070010	56000	56000010
F-150 Heritage	04 - 04	56070	56070010	56000	56000010
F-250 / F-350 Super Duty	17 - 18	57008*	--	57010*	--
	97 - 16	56070	56070010	56000	56000010
F-450 / F-550 Super Duty	99 - 17	56070	56070010	56000	56000010
Nissan					
Titan	04 - 17	56070	56070010	56000	56000010
Titan XD	16 - 17	56070	56070010	56000	56000010
Ram					
1500 / 2500 / 3500	11 - 17	56070	56070010	56000	56000010
Toyota					
Tundra	10 - 17	56070	56070010	56000	56000010

* Includes 57007 isolator kit to prevent corrosion of aluminum body

CUSTOM WIRING

CUSTOM WIRING HARNESS EXTENSION ISOLATOR KIT

- Neoprene well nuts isolate steel bolts from aluminum surfaces
- Securely mounts a 7-way RV blade extension harness in the truck bed
- Designed for specific Ford applications

Make / Model	Years	Part#
Ford		
F-150	15 - 18	57007
F-250 / F-350 Super Duty	17 - 18	57007



PLUGS & SOCKETS

7-WAY RV BLADE EXTENSION

- Routes existing 7-way RV blade socket into full-size pickup truck bed
- Universal size fits any 7-way RV blade socket
- Allows for easy connection of 5th wheel or gooseneck wiring
- 7' extension length accommodates virtually any size truck bed
- Spring-loaded dust cover keeps connector clean when not in use

Pkg#	Length	Fits
56080	7'	7-way RV blade socket



PLUGS & SOCKETS

REPLACEMENT 7-WAY RV BLADE HARNESSES

- Replaces the trailer-end plug of any 7-way harness
- Wires protected by heavy-duty, weather-resistant cable
- Cold-weather harnesses feature soft thermoplastic elastomer casing to remain flexible in cold temperatures (temperature rating from -40°F up to 221°F)

Bulk#	Pkg#	Length	Description
56601	56621	6'	Replacement harness
56602	56622	8'	Replacement harness
56603	56623	10'	Replacement harness
56611	--	6'	Cold-weather replacement harness
56612	--	8'	Cold-weather replacement harness
56613	--	10'	Cold-weather replacement harness



56621 (6')
56622 (8')
56623 (10')

56601 (6')
56602 (8')
56603 (10')



56611 (6')
56612 (8')
56613 (10')

- Connects a towed vehicle to an RV using a standard 4-way flat trailer plug
- Simple plug-and-play design eliminates the need for cutting or splicing
- Integrated block diodes isolate sensitive vehicle electronics from RV signals
- Uses towed vehicle's existing taillights, brake lights and turn signals
- Includes harness, 4-flat extension, mounting bracket and hardware
- Optional harness add-on equips vehicle with standard 4-way flat for towing a trailer (not available for all RV harnesses; see table)



58902



58946



58948

Make / Model	Style	Years	Part#	Add On
Acura				
CL	All	97 - 03	58949	--
Integra	All	94 - 01	58949	--
MDX	All	01 - 07	58949	--
RL	All	96 - 01	58949	--
TL	All	96 - 03	58949	--
Buick				
Enclave	All	13 - 17	58908	3
		08 - 12	58932	1
Rainier	All	04 - 07	58925	--
Cadillac				
Escalade	All	07 - 12	58927	--
Chevrolet				
Avalanche	All	07 - 12	58924	1
Captiva Sport	All	12 - 12	58933	3
Cobalt	Base, sedan	05 - 10	58931	1
	Coupe	05 - 10	58929	1
	LS, sedan	05 - 10	58931	1
	LT, sedan	05 - 10	58931	1
	LTZ	06 - 07	58931	1
	Sport, sedan	08 - 08	58931	1
Colorado	4WD	15 - 16	58910	--
	All	04 - 12	58926	2
Cruze	Diesel	14 - 15	58935	--
	Eco	11 - 15	58935	--
	L	15 - 15	58935	--
	LS, LT, LTZ	11 - 15	58935	--

Make / Model	Style	Years	Part#	Add On
Chevrolet (continued)				
Cruze Limited	All	16 - 16	58935	--
Equinox	All	10 - 17	58900	1
HHR	LS	06 - 11	58929	1
	LS panel	07 - 11	58929	1
	LT	06 - 11	58929	1
	LT panel	07 - 10	58929	1
Malibu	Classic LS and LT	08 - 08	58932	1
	Eco	13 - 14	58934	--
	Hybrid	08 - 10	58932	1
	LS and LT	13 - 15	58934	--
		08 - 12	58932	1
Malibu Limited	LS	16 - 16	58934	--
	LT	16 - 16	58934	--
Silverado 1500	All	07 - 13	58923	1
Sonic	All	12 - 16	58936	--
Suburban 1500	All	07 - 13	58927	--
Tahoe	LS	07 - 12	58927	--
	LT	07 - 12	58927	--
	LTZ	07 - 12	58927	--
	PPV	12 - 12	58927	--
	Trailblazer	All	02 - 08	58925
Traverse	All	13 - 17	58922	3
		09 - 12	58932	1

1. 58918 non-converter add-on compatible
2. 58919 non-powered converter add-on compatible
3. 58920 powered converter add-on compatible

Applications continued on the following page

Make / Model	Style	Years	Part#	Add On
Dodge				
Nitro	All	07 - 11	58937	2
Ram 1500	All	09 - 10	58916	--
Fiat				
500	All	12 - 17	58911	--
Ford				
Edge	All	11 - 14	58914	3
		07 - 10	58952	3
Escape	All	13 - 16	58943	3
Escape	All	05 - 12	58952	3
F-150	All	09 - 14	58912	--
Fiesta	Sedan	11 - 13	58946	--
Flex	Without EcoBoost	09 - 18	58941	1
Focus	Hatchback	12 - 14	58905	--
	Sedan	12 - 17	58944	3
Freestar	All	04 - 07	58952	3
Fusion	All	13 - 17	58945	3
		06 - 12	58942	3
GMC				
Acadia	All	13 - 16	58908	3
		07 - 12	58921	1
Acadia Limited	All	17 - 17	58908	3
Canyon	4WD	15 - 16	58910	--
	All	04 - 12	58926	2
Envoy	All	02 - 09	58925	--
Sierra 1500	All	07 - 13	58923	1
Terrain	All	10 - 17	58900	1
Yukon / Yukon XL 1500	All	07 - 14	58927	--
Honda				
Accord	All	94 - 02	58949	--
CR-V	All	12 - 16	58904	--
		07 - 11	58901	--
		97 - 06	58949	--
Element	All	07 - 11	58947	--
		03 - 04	58949	--
Fit	All	07 - 13	58948	2
Odyssey	All	95 - 04	58949	--
Pilot	All	03 - 08	58949	--
Prelude	All	01 - 01	58949	--
Isuzu				
i-280	All	06 - 06	58926	2
i-290	All	07 - 08	58926	2
i-350	All	06 - 06	58926	2
i-370	All	07 - 08	58926	2
Oasis	All	96 - 99	58949	--

Make / Model	Style	Years	Part#	Add On
Jeep				
Cherokee	75th Anniversary	16 - 16	58909	3
	Latitude, Limited. Sport & Trailhawk	14 - 18	58909	3
	Overland	16 - 18	58909	3
Compass	All	11 - 16	58938	3
Grand Cherokee	65th Anniversary	06 - 06	58939	2
	All	07 - 13	58940	1
		05 - 05	58939	2
		99 - 04	58915	2
	Laredo, Limited & Overland	14 - 15	58907	--
		06 - 06	58939	2
Liberty	All	08 - 12	58937	2
		02 - 07	58917	2
TJ	All	98 - 06	58902	1
Wrangler	All	98 - 06	58902	1
	Excl. right hand drive	07 - 17	58903	1
Lincoln				
MKX	All	11 - 15	58930	3
		07 - 10	58952	3
Mazda				
Tribute	All	08 - 11	58952	3
Mercury				
Mariner	All	05 - 11	58952	3
Oldsmobile				
Bravada	All	02 - 04	58925	--
Pontiac				
G5	Coupe	07 - 09	58929	1
	Sedan	07 - 10	58931	1
Pursuit	Coupe	05 - 06	58929	1
	Sedan	05 - 06	58931	1
Ram				
1500	4WD, with LED taillights	13 - 15	58906	--
	All	11 - 12	58916	--
	Without LED taillights	13 - 13	58916	--
Saturn				
Vue	All	08 - 10	58933	3
	Excluding CVT transmission	02 - 07	58928	2
Suzuki				
Grand Vitara	All	06 - 12	58950	2
SX4	All	07 - 11	58950	2
Toyota				
RAV4	All	06 - 12	58913	3

1. 58918 non-converter add-on compatible
2. 58919 non-powered converter add-on compatible
3. 58920 powered converter add-on compatible



On vehicles with two-wire electrical systems that require a powered converter, the converter's red wire is not used as a stoplight connection and needs to be grounded.

ELECTRICAL CONVERTERS

TAILLIGHT CONVERTERS

For vehicles that are not compatible with CURT custom wiring options, a taillight converter provides a reliable alternative. CURT taillight converters splice into the vehicle's wiring system and convert the signals to be compatible with a trailer's wiring system. Most converters provide a standard output connector, usually in the form of a 4-way flat.

Use the CURT Application Guide, starting on page 32 to find the right wiring solution for your customer.



Advantages of CURT potted enclosures

For increased quality and reliability, select CURT taillight converters feature a potted enclosure. The converter is filled with an epoxy resin that completely seals off the circuit board and gives the converter several advantages.

- Greatly increased protection against impacts and vibrations for longer life
- Impervious to weather and completely sealed off from moisture
- Allows converter to be mounted on the exterior of the vehicle

Application of surface mount technology

Surface mount technology is the most advanced technology for circuit designs, offering a number of benefits over the older through-hole-mount circuit boards. We apply SMT to most of our taillight converters and custom wiring.

- Creates little resistance, reducing heat, limiting voltage drop and extending life
- SMT circuitry efficiency ensures maximum trailer light intensity and life
- Improved mechanical performance under shake and vibration conditions

Bulk#	Bulk 30-Pack#	Pkg#	Pkg Kit#	Pkg Kit# Includes	Battery-Powered	Circuit-Protected	Potted Enclosure	Snap Locks	Left / Right Signal Circuit	Taillight Circuit
Three-Wire to Two-Wire										
--	56146030	56146	59146	55151	Yes	Yes	--	4	3.0 amps	6.0 amps
--	--	56496	NEW 59496	55151	Yes	Yes	Yes	4	3.0 amps	6.0 amps
55177*	--	55178*	55179*	--	--	--	--	--	2.1 amps	5.0 amps
--	56132	56130	--	--	--	--	--	4	3.0 amps	5.0 amps
--	--	56175	--	--	--	Yes	--	4	3.0 amps	5.0 amps
--	--	56187	59187	55151	Yes	--	--	4	3.0 amps	5.0 amps
--	--	56190	59190	55151	Yes	Yes	--	4	7.5 amps	7.5 amps
58240**	--	--	--	--	--	--	--	--	2.1 amps	5.0 amps
For Two-Wire, Three-Wire and PWM ST and STT Systems (Multi-Function)										
--	--	56236	59236	55152	Yes	Yes	Yes	4	5.0 amps	7.5 amps
For Low-Side Switching Systems										
--	--	56195	--	--	Yes	--	--	4	2.1 amps	4.2 amps
Two-Wire to Three-Wire for Dinghy Towing										
--	--	56196**	--	--	--	--	--	--	2.1 amps	5.0 amps
24-Volt Three-Wire to Two-Wire										
--	--	56424	NEW	--	--	--	--	--	2.1 amps	7.5 amps

* Does not use surface mount technology (SMT). See above for more information

** Comes with blunt-cut wires instead of 4-way flat output

**ELECTRICAL
CONVERTERS**

TAILLIGHT CONVERTERS

Standard converters

- Most constructed with surface mount technology
- No heavy-duty flasher required
- Includes converter, 4-way flat loop, four snap locks and four wire connectors (#55179)

Multi-function converter

- Microcontroller senses current to rapidly react to overload
- Provides improved overload, short-circuit and thermal protection
- Low-voltage operation allows function down to seven volts

NEW



56496

Potted converters

- Potted enclosure significantly increases water and vibration resistance
- Constructed with SMT circuitry for better performance and durability
- Provides improved overvolt, ESD and short-circuit protection

**ELECTRICAL
CONVERTERS**

24-VOLT TAILLIGHT CONVERTER

- Primarily used for 24V automotive systems, busses, trucks and cab and chassis wiring
- Equipped with a 24-volt, 3-wire to 2-wire taillight converter
- Designed to operate with both incandescent and LED trailer lighting systems
- 26" color-coded, 16-gauge wires for easy installation and reliable operation
- No heavy-duty flasher or direct battery connection required
- Trailer-side connector not included
- Does not reduce output to 12 volts

NEW



56424

**ELECTRICAL
CONVERTERS**

POWERED CONVERTER WIRING KITS

- Routes power from vehicle battery to powered converter
- Designed for use with battery-powered converters



55151



55152

Pkg#	Amps	Includes						
55151	10	Cross-linked wire, 12 gauge Length: 20 feet	In-line fuse holder, 10-amp (red)	ATC10 fuse, 10-amp (red)	3/8" ring terminal	Butt connector, 12-15 gauge	Cable tie, 14 1/2"	Cable ties, 6" Qty: 8
55152*	15	Cross-linked wire, 12 gauge Length: 20 feet	In-line fuse holder, 15-amp (yellow)	ATC10 fuse, 15-amp (blue)	3/8" ring terminal	Butt connector, 12-15 gauge	Cable tie, 14 1/2"	Cable ties, 6" Qty: 8

* Use with converter part number 56236, see above

4-WAY FLAT

- Single-output adapters adapt a 4-way flat vehicle socket to fit 5-way flat, 6-way round or 7-way RV blade trailer plugs
- Dual-output adapters add a 6-way round or 7-way RV blade to an existing 4-way flat vehicle socket
- Informative, full-color retail packaging

NEW



57186



57185



57187



57183



57184



57626



57676



57604



57624



57672



57674



57102

Pkg#	From Vehicle	To Trailer	Notes	Material
Single Output				
57184	4-way flat	7-way RV blade	See mounting brackets on page 266 and page 267	Plastic
57183	4-way flat	6-way round	See mounting brackets on page 266 and page 267	Die-cast
57185	4-way flat	7-way RV blade	Includes mounting bracket	Steel
57186	4-way flat	7-way RV blade	Includes wiring and components to splice in a brake control connection	Plastic
57187 NEW	4-way flat	5-way flat	--	Plastic
57626*	4-way flat	6-way round	Integrated test lamps display proper connections	Plastic
57676*	4-way flat	7-way RV blade	Integrated test lamps display proper connections	Plastic
Dual Output				
57604*	4-way flat	4-way flat 6-way round	--	Plastic
57624*	4-way flat	4-way flat 6-way round	Integrated test lamps display proper connections	Plastic
57672*	4-way flat	4-way flat 7-way RV blade	--	Plastic
57674*	4-way flat	4-way flat 7-way RV blade	Integrated test lamps display proper connections	Plastic
57102*	4-way flat	4-way flat 7-way RV blade	Audible back-up alarm when vehicle in reverse (97 decibels)	Plastic

* Includes mounting bracket and hardware

ELECTRICAL ADAPTERS

ACCESSORY SOCKET

- Powers accessories with the vehicle's 2-, 4- or 5-way flat connector
- Provides a cigarette lighter type socket

Bulk#	Pkg#	From Vehicle	To Trailer	Material
58312	58313	2-way flat	Accessory socket power adapter	Plastic
		4-way flat		
		5-way flat		



ELECTRICAL ADAPTERS

4-WAY ROUND

- Adapts a 4-way round vehicle socket to fit 4-way flat trailer plugs
- Simple plug-and-play design eliminates the need for cutting or splicing packaging



Bulk#	Pkg#	From Vehicle	To Trailer	Material
58414	--	4-way round	4-way flat	Plastic
57224	57225	4-way round	4-way flat	Plastic
57444	--	4-way round	4-way flat	Die-cast

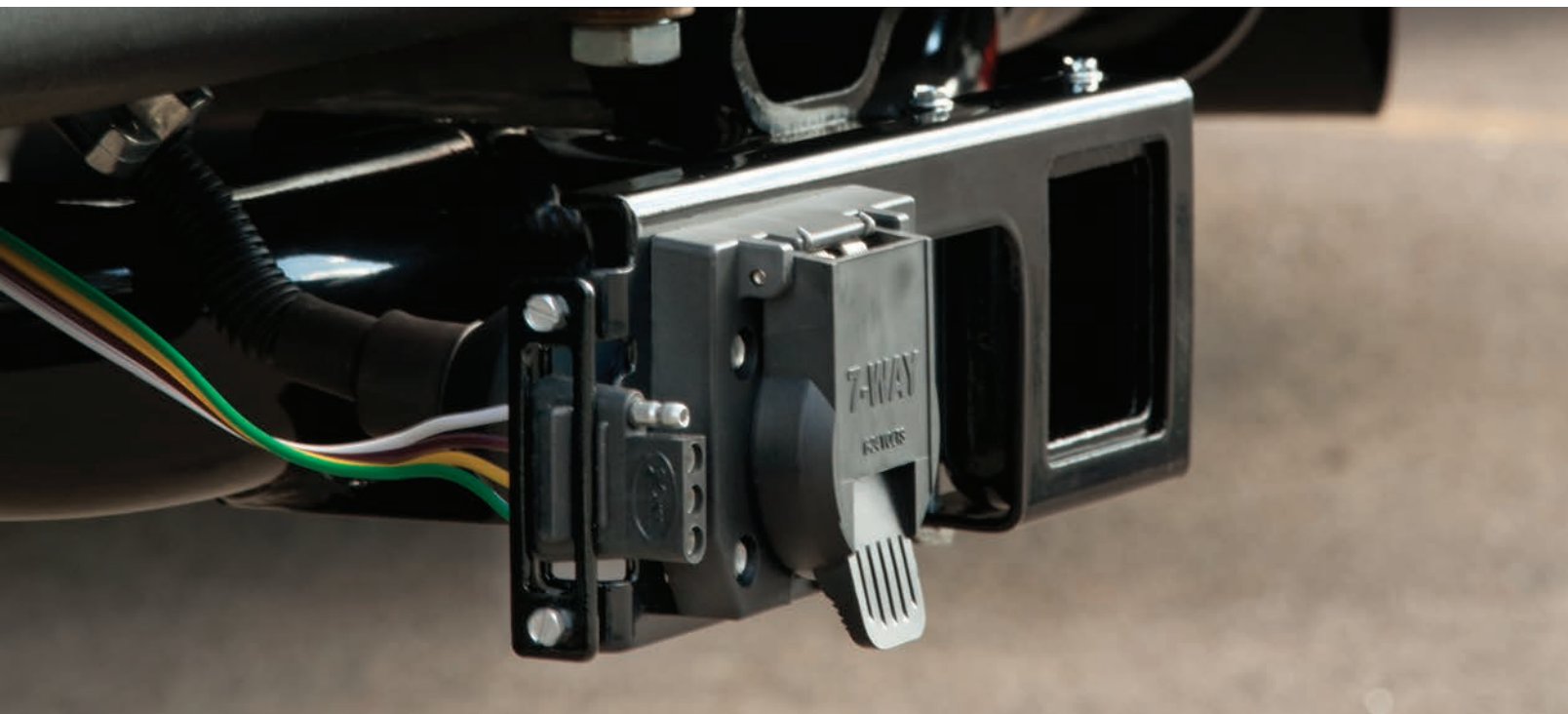

ELECTRICAL ADAPTERS

6-WAY ROUND

- Adapts a 6-way round vehicle socket to fit 4-way flat or 7-way RV blade trailer plugs
- Simple plug-and-play design eliminates the need for cutting or splicing



Bulk#	Pkg#	From Vehicle	To Trailer	Material
57620	57621	6-way round	4-way flat	Plastic
--	57667	6-way round	7-way RV blade	Die-cast and plastic

ELECTRICAL ADAPTERS

6- OR 7-WAY WITH LED DUST COVERS

- Adapts a 6-way round or 7-way RV blade vehicle socket to fit 4-way flat or 6-way round trailer plugs
- LED tester confirms proper vehicle and trailer electrical function
- Dust cover keeps connector clean when not in use
- Simple plug-and-play design eliminates the need for cutting or splicing



Pkg#	From Vehicle	To Trailer	Center Pin Function
57627	6-way round	4-way flat	--
57245	7-way RV blade	4-way flat	--
57255	7-way RV blade	6-way round	Auxiliary power
57265	7-way RV blade	6-way round	Brake lights



57265 LED cover

ELECTRICAL ADAPTERS

7-WAY RV BLADE ADAPTER HARNESSES

- Adapts 7-way RV blade vehicle socket to fit 4- or 5-way flat trailer plugs
- UV-resistant coiled cable extends up to 5' without scraping the ground
- Simple plug-and-play design eliminates the need for cutting or splicing
- Durable molded plastic housing resists corrosion



57271



57281

Pkg#	From Vehicle	To Trailer	Material
57271 NEW	7-way RV blade	4-way flat	Plastic
57281 NEW	7-way RV blade	5-way flat	Plastic

ELECTRICAL ADAPTERS

7-WAY RV BLADE FOR LED TRAILER LIGHTS

- Adapts a 7-way RV blade vehicle socket to fit 4- or 5-way flat, 6-way round or 7-way RV blade trailer plugs
- Enables vehicles with a 7-way RV blade socket to recognize LED trailer lights
- Built-in, integrated resistors for computers that do not recognize LED lights
- Simple plug-and-play design eliminates the need for cutting or splicing



57004



57005



57003

Pkg#	From Vehicle	To Trailer	Material
57003	7-way RV blade	7-way RV blade	Plastic
57004	7-way RV blade	4-way flat	Plastic
		5-way flat	
57005	7-way RV blade	6-way round	Plastic

ELECTRICAL ADAPTERS

7-WAY ROUND AND RV BLADE

- Adapts a 7-way vehicle socket to fit 4- or 5-way flat or 6-way round trailer plugs
- Integrated backup alarm sounds when vehicle is in reverse
- Simple plug-and-play design eliminates the need for cutting or splicing



57240 57241



57250



57251



57260



57261



57660



57661

Bulk#	Pkg#	From Vehicle	To Trailer	Center Pin Function
57240	57241	7-way RV blade	4-way flat	--
57250	57251	7-way RV blade	5-way flat	--
57260	57261	7-way RV blade	6-way round	Auxiliary power
57660	57661	7-way RV blade	6-way round	Brake lights
57040	57041	7-way round	4-way flat	--



57040



57041

ELECTRICAL ADAPTERS

7-WAY RV BLADE WITH BACKUP ALARM OPTION

- Adapts a 7-way vehicle socket to fit 4- or 5-way flat or 6-way round trailer plugs
- Integrated backup alarm sounds when vehicle is in reverse (97 decibels)
- Simple plug-and-play design eliminates the need for cutting or splicing



57724



57725



57720



57726

Pkg#	From Vehicle	To Trailer	Center Pin Function
57724	7-way RV blade	4-way flat	--
57725	7-way RV blade	5-way flat	--
57720	7-way RV blade	6-way round	Brake lights
57726	7-way RV blade	6-way round	Auxiliary power
57727	7-way RV blade	7-way RV blade (extender)	--



57727

PLUGS & SOCKETS

2-WAY FLAT

- Splices into existing wiring to supply power to an electrical accessory
- 18-gauge looped wire can also be used as an extension for an existing connector
- Constructed with bonded wires and durable molded rubber

Bulk#	Pkg#	Location	Wire Length	Description
58020	58021	Vehicle	12"	Socket with bonded loop
		Trailer		Plug with bonded loop



PLUGS & SOCKETS

4-WAY FLAT

- Splices into existing wiring to supply power from the vehicle to the trailer
- Looped wires can also be used as a wire extension for an existing connector
- Constructed with bonded wires and durable molded rubber
- Designed for use on vehicles and trailers with two-wire systems



Bulk#	Pkg#	Pkg Kit#	Location	Wire Length	Description
58030	58031	58033*	Trailer	12"	Plug with bonded wire
--	58348	58349*	Trailer	48"	Plug with bonded wire
58040	58041	58044*	Vehicle	60"	Socket with bonded wire
--	58304	58344*	Vehicle	12"	Socket with bonded wire
			Trailer	12"	Plug with bonded wire
--	58355	58305*	Vehicle	48"	Socket with bonded wire
			Trailer	12"	Plug with bonded wire
58050	58051	--	Vehicle	72"	Socket with bonded loop
			Trailer		Plug with bonded loop
58380	58381	--	Vehicle	12"	Socket with bonded loop
			Trailer		Plug with bonded loop
--	57220	--	Trailer	240"	Plug with bonded wire



*Includes four snap locks

PLUGS & SOCKETS

4-WAY FLAT LICENSE PLATE LIGHT PLUGS

- 1 1/4" plug fits a typical license plate light hole
- Dust cover keeps connector clean when not in use



Bulk#	Pkg#	Location	Wire Length	Description
58404	57404	Vehicle	--	Adapter, dust cap included
		Trailer		
58405	57405	Vehicle	36"	Socket with bonded wire, dust cap included
58406*	57406	Vehicle	60"	Socket with bonded wire, dust cap included

* Continued while supplies last

PLUGS & SOCKETS

4-WAY ROUND

- Splices into existing wiring to supply power from the vehicle to the trailer
- Concealed terminals help ensure a reliable connection
- Constructed from strong die-cast metal
- Dust- and water-resistant design to withstand the elements



Bulk#	Pkg#	Pkg Kit#	Location	Material	Description
58060	58061	--	Trailer	Die-cast	Round plug
58070	58071	--	Vehicle	Die-cast	Round socket
--	58671	58677*	Trailer	Die-cast	Round plug (58060)
			Vehicle	Die-cast	Round socket (58070)

* Includes mounting bracket, wiring and hardware

PLUGS & SOCKETS

4- & 5-WAY FLAT DUST COVERS

- Protects connector from water, dust and road grime when not in use
- Helps prevent internal corrosion for a long operating life
- Attachment loop allows for fast, easy installation
- Constructed from durable molded rubber



58200



58201



58750



58203

58761

Bulk#	Pkg#	Location	Material	Fits
58200	58201	Vehicle	Rubber	4-way flat
58750	--	Trailer	Rubber	4-way flat
--	58761	Vehicle	Rubber	4-way flat
		Trailer		
58202	58203	Vehicle	Rubber	5-way flat

PLUGS & SOCKETS

5-WAY FLAT

- Ideal for trailers with surge brakes, commonly found on larger boat trailers
- Splices into existing wiring to supply power from the vehicle to the trailer
- Looped wires can also be used as a wire extension for an existing connector



58530

58531



58540

58541



58550

58551

Bulk#	Pkg#	Location	Wire Length	Description
58530	58531	Vehicle	60"	Socket with wire
58540	58541	Trailer	48"	Plug with wire
58550	58551	Vehicle	72"	Socket with loop
		Trailer		Plug with loop

PLUGS & SOCKETS

6-WAY ROUND

- Splices into existing wiring to supply power from the vehicle to the trailer
- Concealed terminals help ensure a reliable connection
- Spring-loaded dust covers keep connectors clean when not in use



58120



58082



58083



58093



58130



58080



58081



58092



58090

58091

Bulk#	Pkg#	Pkg Kit#	Location	Material	Description
58080	58081	--	Trailer	Die-cast	Round plug
58120	--	--	Trailer	Plastic chrome	Round plug
58082	58083	--	Trailer	Die-cast	Round plug with spring
58090	58091	--	Vehicle	Die-cast	Round socket
58130	--	--	Vehicle	Plastic	Round socket
--	58092	58093*	Trailer	Die-cast	Round plug (58080)
			Vehicle	Die-cast	Round socket (58090)

* Includes electrical connectors, mounting bracket and hardware

PLUGS & SOCKETS

6-WAY SQUARE

- 6-way square connectors are commonly used on popup campers
- Splices into existing wiring to supply power from the vehicle to the trailer
- Looped wires can also be used as a wire extension for an existing connector



58034

Pkg#	Location	Wire Length	Description
58034	Vehicle	12"	Square socket with loop
	Trailer		Square plug with loop
58035	Vehicle	12"	Square socket with wire
58037	Trailer	12"	Square plug with wire



58035



58037

PLUGS & SOCKETS

7-WAY ROUND

- 7-way round connectors are commonly used on semi- and utility trailers
- Splices into existing wiring to supply power from the vehicle to the trailer
- Constructed from strong die-cast metal



58170



58160



58161



58180

58181

Bulk#	Pkg#	Location	Material	Description
58170	--	Vehicle	Die-cast	Round socket
58160	58161	Trailer	Die-cast	Round plug
58180	58181	Trailer	Die-cast	Round plug with spring

PLUGS & SOCKETS

7-WAY RV BLADE

- Concealed terminals help ensure a reliable connection
- Ergonomic design offers a comfortable, more secure grip (#58145)
- Weather-resistant dust cover features a rubber insert to seal out moisture (#58155)



58140



58141



58145



58155



58190



58220



58150

58151



58417



58152

Bulk#	Pkg#	Pkg Kit#	Location	Material	Description
58140	58141	--	Trailer	Plastic	RV blade plug
--	58145 NEW	--	Trailer	Plastic	Heavy-duty RV blade plug
58150	58151	--	Vehicle	Plastic	RV blade socket
--	58155 NEW	--	Vehicle	Plastic	Heavy-duty RV blade socket
58190	--	--	Trailer	Die-cast	RV blade plug
58220	--	--	Vehicle	Steel	RV blade socket
--	58417	--	Vehicle	Plastic	RV blade socket with mounting bracket
--	--	58152*	Trailer	Plastic	RV blade plug
			Vehicle	Plastic	RV blade socket

* Includes electrical connectors, mounting bracket and hardware

EASY-MOUNT ELECTRICAL BRACKETS

- Allows connectors to be hitch-mounted with no drilling or clamping required
- Two threaded stainless steel bolts provide secure attachment to the hitch
- Notched design allows convenient access to pin & clip
- Steel body will not break like competitive plastic products
- Protected by a durable powder coat finish
- Patent# 5,664,304
- Bulk retail boxes contain 10 poly-bagged units



Allows connectors to be hitch-mounted with no drilling or clamping required

Fits 1 1/4" receiver tubes and holds 4-way or 5-way flats



58002

Fits 2" receiver tubes and holds 4-way or 5-way flats

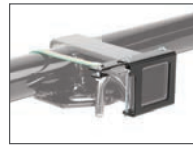

58001

Fits 2" receiver tubes and holds 4- or 5-way flats and 6- or 7-way sockets



58000

Fits 2 1/2" receiver tubes and holds 4- or 5-way flats and 6- or 7-way sockets

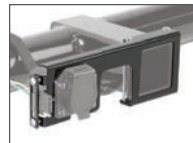

58003

Pkg#	Bulk Retail 10-Pack#	Receiver Tube Opening	Fits
58002	58002010	1 1/4" x 1 1/4"	4- or 5-way flat sockets
58001	58001010	2" x 2"	4- or 5-way flat sockets
58000	58000010	2" x 2"	4- or 5-way flat and 6- or 7-way sockets
58003	--	2 1/2" x 2 1/2"	4- or 5-way flat and 6- or 7-way sockets

58001010
10-pack



ELECTRICAL SOCKET MOUNTING BRACKETS

- Allows for secure connector attachment to the vehicle or trailer hitch
- Steel body will not break like competitive plastic products
- Mounting hardware not included



Bulk#	Bulk 12-Pack#	Pkg#	Fits	Description	Finish
For 4-Way Flat, 5-Way Flat and 6-Way Round Connectors					
58300	--	58301	4-way flat	--	Gloss black
--	57207	57208	4- or 6-way round sockets	--	Gloss black
58210	--	--	4- or 6-way round sockets	--	Zinc-plated
For 7-Way Round and 7-Way RV Blade Connectors					
58222	--	--	7-way round socket #58170	--	Zinc-plated
--	57205	57206	7-way RV blade socket #55415	Increased strength, slotted screw holes	Gloss black
58230	--	58231	7-way RV blade sockets #58150 and #58220	--	Zinc-plated
58290	--	58291	7-way RV blade sockets #58150 and #58220	--	Gloss black
58510	--	--	7-way RV blade sockets #58150 and #58220	Increased strength	Gloss black
58520	--	--	7-way USCAR factory Ford, GM and Nissan sockets	--	Gloss black
For Mounting Connector Brackets to Trailer Hitches					
--	57203	57204	4- or 5-way flat and 6-way round brackets	Short, universal clamp-on mount	Gloss black
--	57201	57202	7-way round or RV blade sockets	Long, universal clamp-on mount	Gloss black

ACCESSORIES & TESTERS

LENSES & COMBO LIGHTS

- Exceeds DOT requirements for stop, tail, rear and side reflectors, side markers and license plate illumination
- Two extra connections provide hookups for other lights
- Features a molded housing with standard red lenses
- Phosphor-bronze contacts for good connection in extreme conditions
- Bolt-on mounting system for secure installation on the trailer



Pkg#	Vehicle Side	Lens Color	License Plate Illumination
53440	Passenger	Red	No
53441	Driver	Red	Yes
53445	Rear replacement lens		
53515	Side replacement lens		

ACCESSORIES & TESTERS

SUBMERSIBLE COMBO LIGHTS

- Exceeds DOT requirements for stop, tail, rear and side reflectors, clearance and license plate illumination
- Watertight design allows for full water immersion
- Provides a great replacement light for boat trailers
- Bolt-on mounting system for secure installation on the trailer
- Legal for trailers over 80" wide



Pkg#	Vehicle Side	Lens Color	License Plate Illumination
53452	Passenger	Red	No
53453	Driver	Red	Yes

ACCESSORIES & TESTERS

TRAILER LIGHT KIT

- Exceeds DOT highway standards
- Designed to replace all necessary trailer lights on most trailers
- Easily connects to any standard automobile lighting system
- Frame mounting clips keep wires contained and protected
- Ideal for trailers up to 80" wide



Pkg#	Length	Plug	Includes
53540	20'	4-way flat	Two combination lights, two marker lights, license plate bracket and frame mounting clips

ACCESSORIES & TESTERS

TOWING LIGHTS

- Easily adds tow lights to a vehicle being dinghy towed
- Non-scratch magnetic base protects vehicle finish
- Perfect for boats, RVs and flat towing applications
- 20' cord with 4-way flat plug allows for plug-and-go convenience
- Snap locks included for simple, secure splice-in connection
- Patent# D355,270



Bulk#	Pkg#	Length	Plug	Description
	53200	53204*	20'	4-way flat
				Auxiliary towing lights

* Includes a sturdy, reusable case

ACCESSORIES & TESTERS

CONNECTOR TESTERS

- Confirms proper vehicle and trailer electrical function
- Constructed with LED lights for long-lasting use



Bulk#	Pkg#	Description	Material
58260	58261	LED 4-way flat	Plastic
57505	--	LED 5-way flat	Plastic
58650	--	LED 6-way round	Plastic
58270	58271	LED 7-way RV blade	Plastic

ACCESSORIES & TESTERS

BRAKE CONTROL TESTERS

- Tests vehicle wiring for battery voltage, brake voltage and signal circuits (#51498)
- Designed to bench test a brake control for proper function (#51521)
- Tests brake voltage, pedal activation, short-circuit / overload and disconnect (#51521)



Bulk#	Tests	Plug	Socket
51498	Vehicle-side wiring functions	7-way RV blade	--
51521	Brake control unit	--	Quick plug

ACCESSORIES & TESTERS

BONDED 4-WIRE SPOOL

- Standard 4-way wire for rewiring a trailer or a similar application



Pkg#	Gauge	Length	Description
57001	16	25'	Bonded four-wire spool (green, yellow, brown, white)

**ACCESSORIES
& TESTERS**

SNAP LOCKS & WIRE NUT

- Instantly splices two wires together using only a pliers
- Aluminum blade pierces both channels to eliminate any stripping or soldering
- Latching safety lock ensures a reliable connection
- Side gap allows for easy insertion of existing wire
- Constructed from high-impact plastic to protect against corrosion



Bulk#	Gauge	Description	Quantity
58280	18-14	Tap connector	100
59906	18-14	Double-run tap connector	100
59956	18-14	Tap connector with gel sealant	100
59905	12-10	Tap connector	100
59901	18-10	Wire nut	100

**ACCESSORIES
& TESTERS**

RING & SPADE TERMINALS

- Allows wires to be fastened down for a firm connection
- Perfect for installing towing electrical components or similar applications
- Vinyl-insulated to ensure a long-lasting connection
- Flared opening allows for easy wire insertion



Bulk#	Gauge	Stud Size	Color	Quantity
Ring Terminals				
59521	16-14	#10	Blue	100
59522	16-14	1/4"	Blue	100
59525	16-14	5/16"	Blue	100
59523	16-14	3/8"	Blue	100
59531	12-10	#10	Yellow	100
59534	12-10	1/4"	Yellow	100
59556	12-10	5/16"	Yellow	100
59538	12-10	3/8"	Yellow	100
Spade Terminals				
59611	22-18	#10	Red	100
59621	16-14	#10	Blue	100
59631	12-10	#10	Yellow	100

**ACCESSORIES
& TESTERS**

BUTT & QUICK CONNECTORS

- Quick connectors provide a firm wire connection with the option to disconnect later
- Butt connectors splice wires together with no taping required
- Perfect for installing towing electrical components or similar applications
- Vinyl-insulated to ensure a long-lasting connection
- Flared opening allows for easy wire insertion

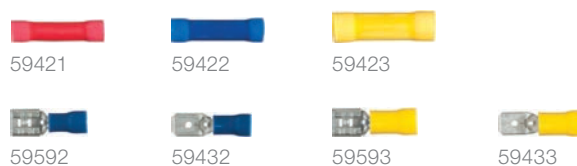

Bulk#	End	Gauge	Color	Quantity
Butt Connectors				
59421	--	22-18	Red	100
59422	--	16-14	Blue	100
59423	--	12-10	Yellow	100
Quick Connectors				
59592	Female	16-14	Blue	100
59432	Male	16-14	Blue	100
59593	Female	12-10	Yellow	100
59433	Male	12-10	Yellow	100

**ACCESSORIES
& TESTERS**

HEAVY-DUTY FLASHERS, CIRCUIT BREAKERS & FUSES

- Recommended for applications where over-current protection is required
- Turn signal flashers are 12-volt, two-terminal flashers



Bulk#	Amps	Description	Qty
Fuses and Holder			
58440	10 amps	ATC fuse	100
58450	15 amps	ATC fuse	100
58460	20 amps	ATC fuse	100
58470	10 amps	In-line fuse holder	12
Relays			
58480	35 amps	Relay, SPNO, 4-terminal, 12-volt DC	12
57000	--	Nissan '04 to present Armada and Titan without factory tow package	1

Bulk#	Amps	Description	Qty
Flashers			
58310	14 amps	Flasher 1-4 lamps or 2-8 hazard	1
58320	14 amps	Flasher 2-3 lamps or 2-6 hazard	1
Circuit Breaker			
58340	15 amps	Universal circuit breaker	1
58350	20 amps	Universal circuit breaker	1
58360	30 amps	Universal circuit breaker	1
58370	40 amps	Universal circuit breaker	1

**ACCESSORIES
& TESTERS**

SLIT LOOM & CLAMP

- Protects loose wires against vibration and damage
- Keeps multiple wires contained in a single channel
- Slit lengthwise for easy application to wires
- Stronger and easier to use than a braided sleeve or wire spiral wrap



Bulk#	Pkg#	Description	Amount
58823	--	1/4" convoluted slit loom	Per foot
59824	59825	3/8" convoluted slit loom	Per foot / 25'
59826	59827	1/2" convoluted slit loom	Per foot / 25'
--	59828	3/8" ID nylon loom clamp	25 per bag

**ACCESSORIES
& TESTERS**

ELECTRICAL TAPE & NYLON TIES

- Self-locking ties for securing wires and cables
- Zip tie mechanism allows for tight bundling
- Tapered end for easier insertion into lock



Bulk#	Length	Quantity	Specifications	Description
59728	7 1/4"	100	--	Nylon ties
59732	14 1/4"	100	--	Nylon ties
59740	60'	10-pack	7 mil x 3/4"	Electrical tape



GOOSENECK HITCHES

TESTING THE LIMITS

CURT gooseneck hitches are engineered and tested to keep up with your hardworking customers. New for 2018, we have added an OEM-style hitch made specifically for Ford Super Duty trucks. This hitch features a one-person install, a limited lifetime warranty and is made in the USA. We also continue to offer OEM puck system kits for Ford, GM, Nissan and Ram, and our easy-to-install, easy-to-operate Double Lock EZr™. See page 274 for a helpful hitch selection guide.

FEATURED PRODUCTS



OEM puck system kits

Equip your customers to tow gooseneck trailers instantly with an OEM puck system kit, available for Ford, GM, Nissan and Ram.



OEM-style hitches

With a custom-fit design, OEM-style hitches are fast and easy to install on your customer's truck. They are available for Ford and Ram.



Double Lock EZr™

Boasting a one-person, no-measure install and easy operation, the EZr™ is the gooseneck hitch of choice for both you and your customers.

PRODUCT INDEX

A B C



274
Selecting a
Gooseneck

276
OEM Puck
System Kits



278
Double Lock
EZr™ Hitches



280
OEM-Style
Hitches



281
X5 Gooseneck
Adapter Plates



282
Original Double
Lock Hitches



286
Quick Goose II
Hitches



288
Over-Bed
Hitches



290
5th Wheel Rail
Hitches



291
Gooseneck
Electrical

SELECTING A GOOSENECK HITCH

There are three basic methods for installing a gooseneck hitch in your customer's pickup truck:

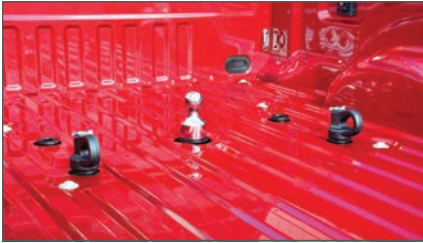

A Using an OEM puck system, if equipped



B Using brackets and a gooseneck head



C Using pre-existing 5th wheel base rails

A | INSTALLING WITH AN OEM PUCK SYSTEM

Many pickups today, specifically models from Ford, GM, Nissan and Ram, are factory equipped with a truck bed puck system. A puck system provides attachment points for both gooseneck and 5th wheel towing.

For trucks with a puck system, an OEM puck system gooseneck kit is the easiest way to tow a gooseneck trailer. The components can be installed or removed quickly when necessary.

See page 276 to select one of these kits.

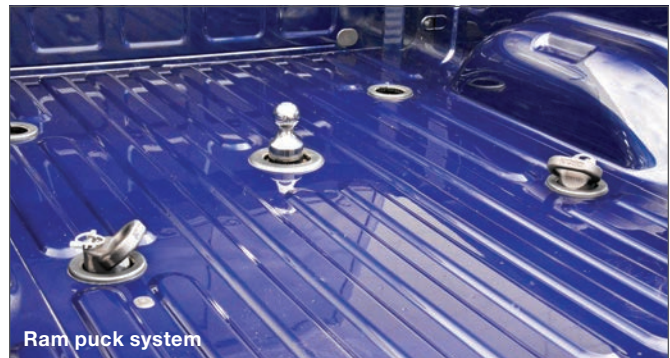

Ram puck system

Quarter-turn anchoring system



Step 1 - Lift and twist latch to release the retention balls



Step 2 - Drop the ball into OEM puck system hole



Step 3 - Return latch to lock the ball in place for towing



Large safety chain openings accept heavy-duty hooks

B | INSTALLING WITH CUSTOM BRACKETS

For trucks without a puck system, the traditional method for installing a gooseneck hitch is vehicle-specific brackets. The brackets bolt onto the frame of the truck to permanently mount the gooseneck hitch.

For the easiest installation available, we recommend our Double Lock EZr™. This hitch is uniquely designed for one-person installation, with no measuring required. It also has a flip-and-store trailer ball to not obstruct the truck bed.

To learn more about the Double Lock EZr™ and its one-person installation, see page 278.

The Double Lock EZr™ is not available for certain Ram and Ford trucks.

Refer to the table on page 280 for our available OEM-style gooseneck hitches.

CURT also offers a variety of other gooseneck hitches, such as our original Double Lock and Quick Goose II, providing coverage for a wide range of vehicles, including many older trucks.

See the rest of our gooseneck line, starting on page 282.



C | INSTALLING WITH EXISTING 5TH WHEEL BASE RAILS

For trucks with 5th wheel rails already installed, CURT offers 5th wheel rail gooseneck hitches. These 5th-wheel-to-gooseneck adapters feature a four-point mounting system to easily drop into any set of industry-standard 5th wheel base rails.

A 5th wheel rail gooseneck hitch provides a ball ready for towing a gooseneck trailer, and the hitch can easily be removed from the base rails whenever necessary to allow for 5th wheel towing.

See page 290 to select a 5th wheel rail gooseneck hitch.

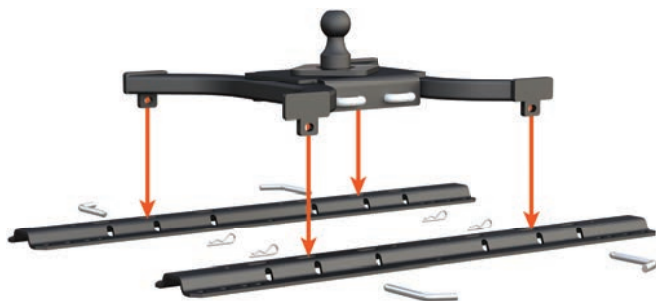

USING AN OEM PUCK SYSTEM

30k

GTW

OEM PUCK SYSTEM GOOSENECK KITS

These kits utilize the truck bed puck system built into certain models of Ford, GM, Nissan and Ram pickups. The ball and anchors easily drop into the pucks, lock into place and are immediately ready to couple to a gooseneck trailer.

See page 274 for a helpful gooseneck hitch selection guide.

Each kit includes:

- Gooseneck ball
- Two safety chain anchors
- Rubber hole cover
- Durable storage case



60692

Quarter-turn anchoring system



Step 1 - Lift and twist latch to release the retention balls



Step 2 - Drop the ball into OEM puck system hole



Step 3 - Return latch to lock the ball in place for towing



Large safety chain openings accept heavy-duty hooks

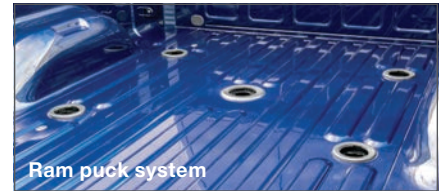

Installation of these products requires an OEM truck bed puck system (example above)

Product Details

Gooseneck ball

- Up to 30,000 lbs. GTW and 7,500 lbs. vertical load
- Weight ratings are limited to vehicle manufacturer's stated capacities
- Installs easily with quarter-turn latch locking system
- 2 5/16" ball couples to most gooseneck trailers
- Retention balls keep shank fully locked into the hitch
- Constructed from strong, machine-forged steel alloy
- Protected by a polished chrome-plated mirror finish
- Tested for safety to U.S. VESC V-19 specifications
- Patent# 8,955,866
- Limited lifetime warranty

Safety chain anchors

- Provides a reliable connection for gooseneck trailer safety chains
- Simple, drop-in install eliminates the need for tools
- Wide openings accept large safety chain hooks
- Constructed from heavy-duty, forged steel
- Durable carbide black powder coat finish
- Patent pending
- Limited lifetime warranty

30k
GTW

OEM PUCK SYSTEM GOOSENECK KITS



OEM puck system gooseneck components are easy to install whenever needed

Pkg#	Make	Ball GTW / Vertical Load	Ball Size	Ball Finish	Anchor Finish
60618	Ram	30,000 / 7,500 lbs.	2 5/16"	Chrome-plated	Carbide
60692	Chevrolet / GMC, Ford and Nissan	30,000 / 7,500 lbs.	2 5/16"	Chrome-plated	Carbide

OEM PUCK SYSTEM GOOSENECK KIT REPLACEMENT PARTS



Part#	Make	Ball Size	Description	Finish
60617	Ram	--	Two safety chain anchors	Carbide
60691	Chevrolet / GMC, Ford and Nissan	--	Two safety chain anchors	Carbide
60601	Ram	2 5/16"	OEM-style gooseneck ball	Chrome-plated
60629	Chevrolet / GMC, Ford and Nissan	2 5/16"	OEM-style gooseneck ball	Chrome-plated
66155	--	--	Replacement rubber hole cover	Black rubber



USING CUSTOM BRACKETS

30k

GTW

DOUBLE LOCK EZr™ GOOSENECK HITCH SYSTEM



60611

What makes the EZr™ different?

One-person installation



Easy-to-install clips eliminate the need for a second person to hold up the center section

- Retainer clips secure the bolts supporting the center section while attaching the installation kit
- Uses carriage bolts when possible for one-wrench tightening
- No need to lower exhaust on Ford, GM and most Dodge / Ram models
- No need to relocate cable hanger and ground wire on Dodge / Ram models

No measuring required



Exclusive Center Locator saves time

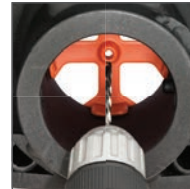

Simply drill up from under the bed

- Exclusive Center Locator eliminates the need to measure where the ball hole should be
- Safety chain loop holes are drilled from the underside of the truck bed
- No welding or truck bed removal required
- Center Locator covered by patent# D685,299 S

How is the EZr™ installed without measuring?

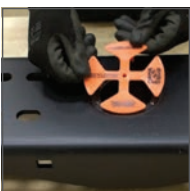

Step 1 - Place the Center Locator into the gooseneck hitch ball hole



Step 2 - Bolt the installation brackets and hitch to the vehicle frame



Step 3 - Drill a pilot hole up from under the bed, using the Center Locator



Step 4 - Use the pilot hole to drill down with no measuring required

Product Details & Operation

- Up to 30,000 lbs. GTW and 7,500 lbs. vertical load
- Weight ratings are limited to vehicle manufacturer's stated capacities
- Includes 2 5/16" ball, 5/8" safety chain loops and grade 8 hardware
- Protected by a durable carbide powder coat finish
- Tested for safety in accordance with SAE J2638
- Informative, full-color retail packaging
- Limited lifetime warranty



60680

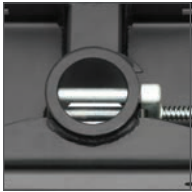

Engage the double locking pins for superior pin strength

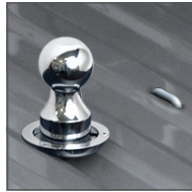

Retract the sturdy 3/8" handle and drop the ball into the hole

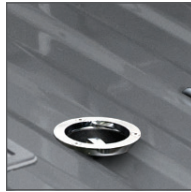

After towing, flip the ball over to eliminate obstructions

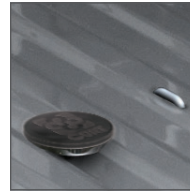

Install the hole cover to protect the ball from the elements



66165
Replacement rubber hole cover available



60616
Replacement gooseneck ball available

If a particular application is not listed in the table below, see the original Double Lock gooseneck hitch application guide on page 284

Make / Model	Style	Years	EZr™ Kit#	Notes	Bracket#	EZr™ Hitch#
Chevrolet						
Silverado 2500 HD / 3500 HD	High Country	15 - 18	60680	●, 1	60624	60611
	LT	11 - 18	60680	●, 1	60624	60611
	LTZ	11 - 18	60680	●, 1	60624	60611
	WT	11 - 18	60680	●, 1	60624	60611
	--	01 - 10	60681	●	60648	60619
Dodge						
Ram 2500 / 3500	--	03 - 10	60682 NEW	●, 1, 6, 7	60660	60619
Ford						
F-250 / F-350 Super Duty	--	11 - 16	60683 NEW	●	60645	60619
		99 - 10	60685 NEW	●	60647	60619
		17 - 17	See page 280 for OEM-style gooseneck hitch			
GMC						
Silverado 2500 HD / 3500 HD	Base	15 - 18	60680	●, 1	60624	60611
	Denali	11 - 18	60680	●, 1	60624	60611
	SLE	11 - 18	60680	●, 1	60624	60611
	SLT	11 - 18	60680	●, 1	60624	60611
	WT	11 - 14	60680	●	60624	60611
	--	01 - 10	60681	●	60648	60619
Ram						
2500	--	11 - 13	60682 NEW	●, 1, 6, 7	60660	60619
		14 - 17	See page 280 for OEM-style gooseneck hitch			
3500	--	11 - 12	60682 NEW	●, 1, 6, 7	60660	60619
		13 - 17	See page 280 for OEM-style gooseneck hitch			

1. Passenger-side wheel well flange must be bent for frame rail access

6. Check inverted ball clearance with heavy loads on two-wheel drive

7. Exhaust may have to be permanently lowered on power wagon and Mega Cab applications

● = No frame drilling required



30k
GTW

OEM-STYLE GOOSENECK HITCHES

OEM-style gooseneck hitches are designed for a unique, vehicle-specific fit. They quickly and securely bolt onto the vehicle's frame with no drilling or installation brackets required.

Product Details

- Up to 30,000 lbs. GTW and 7,500 lbs. vertical load
- Weight ratings are limited to vehicle manufacturer's stated capacities
- Quickly bolts on underneath the truck bed in 45 minutes or less (#60614, #60626)
- Easy, one-person installation requires no lowering of exhaust or spare tire (#60700)
- Requires no additional hardware or installation brackets
- No drilling necessary except the truck bed holes
- Installation also requires no welding, bed flange trimming or bed removal
- Included patented 2 5/16" ball eliminates the need for a side handle
- Heavy-duty 5/8" safety chain loops for a reliable connection
- Tested for safety in accordance with SAE J2638
- Not compatible with X5 adapters
- Protected by a highly durable, rust-resistant, liquid A-coat
- Limited lifetime warranty



NEW

60626



60614



NEW

60700

Quarter-turn gooseneck ball

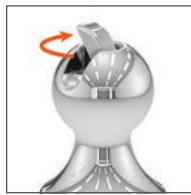

60601 factory-style gooseneck ball operates with a simple, 1/4-turn latch-locking system

66155 replacement

Part#	Make / Model	Description	Years	Ball Size	Finish	GTW / Vertical Load
60626 NEW	Ram 3500	Gooseneck hitch	13 - 17	2 5/16"	A-coat	30,000 / 7,500 lbs.
60614	Ram 2500	Gooseneck hitch	14 - 17	2 5/16"	A-coat	30,000 / 7,500 lbs.
60700 NEW	Ford	Gooseneck hitch	17 - 17	2 5/16"	A-coat	30,000 / 7,500 lbs.
60601	Ford and Ram	Replacement OEM-style ball	--	2 5/16"	Chrome-plated	30,000 / 7,500 lbs.
66155	--	Replacement rubber hole cover	--	--	Black rubber	--

20k
GTW

X5 GOOSENECK TO 5TH WHEEL ADAPTER PLATES

The X5 adapter plate allows a gooseneck hitch to become a mounting platform for a 5th wheel hitch. The X5 shank simply drops into the gooseneck ball hole and instantly provides a set of industry-standard 5th wheel base rails. See the table below for gooseneck hitch compatibility.

For more information about selecting a 5th wheel hitch, see page 294.

Product Details

- Converts a gooseneck hitch into a set of standard 5th wheel base rails
- Simple, secure design allows for fast installation and removal as needed
- For use with CURT and competitive 5th wheels up to 20,000 lbs.
- Capacity limited to lowest-rated towing component
- Accepts any standard CURT 5th wheel legs or roller (excludes OEM puck system)
- Protected by a durable carbide powder coat finish
- Co-cured in a rust-resistant liquid Bonderite® coating
- **Not compatible with OEM-style gooseneck hitches**
- **Not compatible with Sidewinder™ pin boxes**
(Trademark of Cequent Consumer Products™)



16210 - Fits CURT original Double Lock



16220 - Fits CURT Double Lock EZr™



16310 - Fits B&W Turnoverball®

Part#	Fits	Capacity	Shank Style
16210	CURT Double Lock 60607, 60615, 60620, 60625	20,000 lbs.	Round shank
16220	CURT Double Lock EZr™ 60611 and 60619	20,000 lbs.	Round shank
16310	B&W Turnoverball® gooseneck hitch (does not work with shallow models)	20,000 lbs.	Square shank



USING CUSTOM BRACKETS

30k

GTW

ORIGINAL DOUBLE LOCK GOOSENECK HITCHES

- Double locking pins for superior trailer and trailer ball security
- Flip-and store ball keeps truck bed free of obstructions
- Installation requires no welding or truck bed removal
- Heavy-duty handle can be positioned on either side of the vehicle
- Rubber hole cover helps prevent corrosion in trailer ball hole
- Includes spring-loaded safety chain loops and grade 8 hardware
- Protected by a durable carbide powder coat finish
- Limited lifetime warranty

Installation brackets required.
See guide on page 284



60607

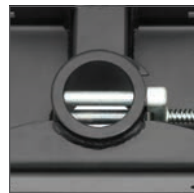

Engage the double locking pins for superior pin strength

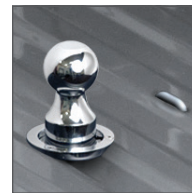

Retract the sturdy 3/8" handle and drop the ball into the hole



Chrome trim ring for a clean, professional finish

Part#	Make / Model	Style	Years	Ball Size	Finish	GTW / Vertical Load
60607*	See page 284 for full list of applications	--	--	2 5/16"	Carbide	30,000 / 7,500 lbs.
60615	Chevrolet Silverado / Sierra 1500 / 2500LD	New body	07 - 17	2 5/16"	Carbide	30,000 / 7,500 lbs.
60620	Nissan Titan	--	04 - 15	2 5/16"	Carbide	30,000 / 7,500 lbs.
60625	Toyota Tundra	--	00 - 06	2 5/16"	Carbide	30,000 / 7,500 lbs.

Installation brackets required for these products. See guide on page 284

* Informative, full-color retail packaging

ORIGINAL DOUBLE LOCK GOOSENECK HITCH ACCESSORIES

- Trailer balls fit all original Double Lock gooseneck hitches



60616



60602



60603



60606



66165

Bulk#	Pkg#	Description	Ball Size	Ball Rise	Ball Offset	GTW / Vertical Load
60616	--	Replacement ball for original Double Lock and EZr™ hitches	2 5/16"	--	--	30,000 / 7,500 lbs.
--	60602	Moves pivot point rearward for added cab clearance	2 5/16"	--	4"	20,000 / 5,000 lbs.
--	60603	Adds clearance for trucks with plastic or rubber bed liners	2 5/16"	1"	--	30,000 / 7,500 lbs.
60606	--	Supports gooseneck hitch for one-person installation	--	--	--	--
66165	--	Replacement rubber hole cover	--	--	--	--

See page 284 for original
Double Lock application guide





On two-wheel drive trucks, a clearance check must be performed when truck is loaded and unloaded to verify the inverted ball will not interfere with the top of the differential. See footnote 6 for more details.

30k
GTW

ORIGINAL DOUBLE LOCK KITS & APPLICATION GUIDE

Make / Model	Style	Years	Double Lock Kit#	Foot Notes	Double Lock Hitch#	Bracket#	
Chevrolet							
Silverado 1500	--	07 - 18	60711	●	60615	60632	
	Classic body	99 - 07	60712	●	60607	60652	
Silverado 1500 Classic	--	07 - 07	60712	●	60607	60652	
Silverado 1500 HD Classic	--	07 - 07	60712	●	60607	60652	
Silverado 2500	--	99 - 04	60712	●	60607	60652	
Silverado 2500 HD	High Country	15 - 18	60710	●	60607	60604	
	LT	11 - 18	60710	●	60607	60604	
	LTZ	11 - 18	60710	●	60607	60604	
	WT	11 - 18	60710	●	60607	60604	
	--	01 - 10	60712	●, 4	60607	60652	
Silverado 3500 HD	High Country	15 - 18	60710	●	60607	60604	
	LT	11 - 18	60710	●	60607	60604	
	LTZ	11 - 18	60710	●	60607	60604	
	WT	11 - 18	60710	●	60607	60604	
	--	01 - 10	60712	●, 4	60607	60652	
	Old body	99 - 00	60713	●	60607	60631	
Full Size Pickups	Excluding 34" frame (O.D.)	88 - 98	60713	●	60607	60631	
Dodge							
Ram 1500	Excluding factory air suspension	09 - 10	60730	●	60607	60657	
	--	02 - 08	60733	1, 2	60607	60659	
		94 - 01	60734	●	60607	60635	
Ram 2500	--	03 - 10	60732	●, 1, 2, 6	60607	60661	
		94 - 02	60734	●, 6	60607	60635	
Ram 3500	--	03 - 10	60732	●, 1, 2, 6	60607	60661	
		94 - 02	60734	●, 6	60607	60635	
Ford							
F-150	King Ranch	15 - 18	60724	●	60607	60649	
	Lariat	15 - 18	60724	●	60607	60649	
	Limited	16 - 18	60724	●	60607	60649	
	Platinum	15 - 18	60724	●	60607	60649	
	Raptor	17 - 18	60724	●	60607	60649	
	SSV	16 - 18	60724	●	60607	60649	
	XL	15 - 18	60724	●	60607	60649	
	XLT	15 - 18	60724	●	60607	60649	
	--		04 - 14	60721	●	60607	60641
			97 - 03	60722	●	60607	60637
			80 - 96	60723	●, 1	60607	60636
	Heritage Edition	04 - 04	60722	●	60607	60637	
F-250	New body	97 - 03	60722	●	60607	60637	
	Old body	80 - 98	60723	--	60607	60636	

All models: Brake, fuel and electrical lines may need to be loosened or repositioned. Heat shield requires modification or removal.

- | | |
|--|---|
| 1. Passenger-side wheel well must be notched for frame rail access | 4. Vacuum canister requires relocation (kit included) |
| 2. Parking brake cable bracket may require relocation | 5. Ball cannot be turned over. Brake lines must be cable-tied (ties included) |
| 3. Exhaust may have to be permanently lowered on 2005 and newer models | 6. Do not invert ball with heavy loads on 2 wheel drive models |
| | ● = No frame drilling required |

Make / Model	Style	Years	Double Lock Kit#	Foot Notes	Double Lock Hitch#	Bracket#
Ford (continued)						
F-250 & F-350 Super Duty	--	11 - 16	60720	●, 3	60607	60644
		99 - 10	60720	●, 3	60607	60644
F-350	Excluding overload springs	80 - 98	60723	●	60607	60636
	--	80 - 98	60723	--	60607	60636
F-450 Super Duty	Excluding cab & chassis	08 - 12	60720	●, 3	60607	60644
GMC						
Sierra 1500	--	07 - 18	60711	●	60615	60632
	Classic body	99 - 07	60712	●	60607	60652
Sierra 1500 Classic	--	07 - 07	60712	●	60607	60652
Sierra 1500 HD Classic	--	07 - 07	60712	●	60607	60652
Sierra 2500	--	99 - 04	60712	●	60607	60652
Sierra 2500 HD	Base	15 - 18	60710	●	60607	60604
	Denali	11 - 18	60710	●	60607	60604
	SLE and SLT	11 - 18	60710	●	60607	60604
	WT	11 - 14	60710	●	60607	60604
	--	01 - 10	60712	●, 4	60607	60652
Sierra 3500 HD	Base	15 - 18	60710	●	60607	60604
	Denali	11 - 18	60710	●	60607	60604
	SLE	11 - 18	60710	●	60607	60604
	SLT	11 - 18	60710	●	60607	60604
	WT	11 - 14	60710	●	60607	60604
	--	01 - 10	60712	●, 4	60607	60652
	Old body	99 - 00	60713	●	60607	60631
Full Size Pickups	Excluding 34" frame (O.D.)	88 - 98	60713	●	60607	60631
Nissan						
Titan	--	17 - 17	60740	●, 1	60620	60664
		04 - 15	60740	●, 1	60620	60664
Ram						
1500	Air suspension	13 - 16	60731	●	60607	60658
	Excluding factory air suspension	11 - 17	60730	●	60607	60657
2500	--	11 - 13	60732	●, 1, 2, 6	60607	60661
3500	--	11 - 12	60732	●, 1, 2, 6	60607	60661
Toyota						
Tundra	Base, 6.5' bed	07 - 13	60751	●, 5	60607	60667
	Limited, 6.5' bed	07 - 18	60751	●, 5	60607	60667
	SR, 6.5' bed	14 - 18	60751	●, 5	60607	60667
	SR5, 6.5' bed	14 - 18	60751	●, 5	60607	60667
	SR5, 6.5' bed	07 - 11	60751	●, 5	60607	60667
	TRD Pro, 6.5' bed	15 - 17	60751	●, 5	60607	60667
	--	00 - 06	60750	●, 6	60625	60665

All models: Brake, fuel and electrical lines may need to be loosened or repositioned. Heat shield requires modification or removal.

- | | |
|--|---|
| 1. Passenger-side wheel well must be notched for frame rail access | 4. Vacuum canister requires relocation (kit included) |
| 2. Parking brake cable bracket may require relocation | 5. Ball cannot be turned over. Brake lines must be cable-tied (ties included) |
| 3. Exhaust may have to be permanently lowered on 2005 and newer models | 6. Do not invert ball with heavy loads on 2 wheel drive models |
| | ● = No frame drilling required |

30k

GTW

UNDER-BED QUICK GOOSE II GOOSENECK HITCHES

- Two-handle operation for raising and lowering the gooseneck ball
- Dual handles eliminate the need to climb in and out of the truck bed
- Drop-ball storage keeps the truck bed free of obstruction
- Installation requires no welding or truck bed removal
- Heavy-duty handles can be positioned on either side of the vehicle
- Chrome-plated trim ring provides a finished look
- Rubber hole cover #66145 helps prevent corrosion in trailer ball hole
- Includes spring-loaded safety chain loops and grade 8 hardware
- Protected by a durable carbide powder coat finish
- Informative, full-color retail packaging
- Limited lifetime warranty

Installation brackets required.
See guide on page 287



60630



66145



Raise / lower the trailer ball without climbing in truck bed



Ball up, ready for coupling

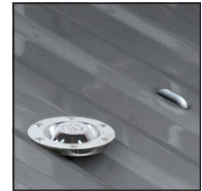

Ball stored, without included rubber cover

Bulk#	Pkg#	Description	Make	Ball Size	Finish	GTW / Vertical Load
--	60630	Quick Goose II gooseneck hitch	Chevrolet / GMC and Ford	2 5/16"	Carbide	30,000 / 7,500 lbs.
--	60640	Quick Goose II gooseneck hitch	Dodge / Ram and Ford	2 5/16"	Carbide	30,000 / 7,500 lbs.
66145	--	Replacement rubber hole cover	--	--	Black rubber	--

30k

GTW

UNDER-BED FOLDING BALL GOOSENECK HITCH

- Folding ball design keeps truck bed free of obstructions
- Permanently attached gooseneck ball cannot be loosened or stolen
- Chrome-plated 2 5/16" trailer ball fits all standard gooseneck trailers
- Includes spring-loaded safety chain loops and grade 8 hardware
- Protected by a highly durable carbide powder coat finish
- Patent# D656,437 and D664,076
- Informative, full-color retail packaging
- Limited lifetime warranty

Installation brackets required.
See guide on page 287



61652



Pull ball pin, raise cover



Lower ball, close cover



Ball stored

Pkg#	Ball Size	Finish	GTW / Vertical Load
61652	2 5/16"	Carbide	30,000 / 7,500 lbs.



On two-wheel drive trucks, a clearance check must be performed when truck is loaded and unloaded to verify the inverted ball will not interfere with the top of the differential. See footnote 6 for more details.

QUICK GOOSE II & FOLDING BALL APPLICATION GUIDE

- Weight ratings are limited to vehicle manufacturer's stated capacities
- Vehicle-specific design optimizes strength and installation time
- Protected by a rust-resistant liquid Bonderite® coating
- Includes grade 8 mounting hardware



60667

Make / Model	Style	Years	Bracket#	Quick-Goose II Hitch#	Folding Ball Hitch#	Foot Notes
Chevrolet / GMC						
Silverado / Sierra 1500	Classic body	99 - 07	60652	60630	61652	●
Silverado / Sierra 2500	--	99 - 04	60652	60630	61652	●
Silverado / Sierra 2500HD / 3500	--	01 - 10	60652	60630	61652	●, 4
Silverado / Sierra 2500 / 3500	Old body	01 - 10	60652	60630	61652	●, 4
		99 - 00	60631	60630	61652	●
Full-size pickup trucks	Excluding 34" frame (O.D.)	88 - 98	60631	60630	61652	●
Dodge						
Ram 1500	--	02 - 08	60659	60640	--	1, 2
		94 - 01	60635	60640	--	●
Ram 2500	--	03 - 10	60661	--	61652	●, 1, 2, 6
		94 - 02	60635	60640	--	●, 6
Ram 3500	--	03 - 10	60661	--	61652	●, 1, 2, 6
		94 - 02	60635	60640	--	●, 6
Ford						
F-150	--	04 - 14	60641	60630	61652	●
		97 - 03	60637	60630	61652	●
		80 - 96	60636	60630	61652	●, 1
F-250	Heritage Edition	04 - 04	60637	60630	61652	●
	New body	97 - 03	60637	60630	61652	●
F-250 / F-350 Super Duty	Old body	80 - 98	60636	60630	61652	--
		--	11 - 16	60644	60630	61652
F-350	Excluding overload springs	99 - 10	60644	60640	--	●, 3
		--	80 - 98	60636	60630	61652
F-450 Super Duty	Excluding cab & chassis	80 - 98	60636	60630	61652	--
		08 - 12	60644	60640	--	●, 3
Ram						
2500	--	11 - 13	60661	--	61652	●, 1, 2, 6
3500	--	11 - 12	60661	--	61652	●, 1, 2, 6

All models: Brake, fuel and electrical lines may need to be loosened or repositioned. Heat shield requires modification or removal.

1. Passenger-side wheel well must be notched for frame rail access
 2. Parking brake cable bracket may require relocation
 3. Exhaust may have to be permanently lowered on 2005 and newer models
 4. Vacuum canister requires relocation (kit included)
 5. Ball cannot be turned over. Brake lines must be cable-tied (ties included)
 6. Do not invert ball with heavy loads on 2 wheel drive models
- = No frame drilling required

30k

GTW

OVER-BED FOLDING BALL GOOSENECK HITCH

- Folding ball design keeps truck bed free of obstructions
- Stainless steel safety pin and pivot spring prevent binding
- Permanently attached gooseneck ball cannot be loosened or stolen
- Chrome-plated 2 5/16" trailer ball fits all standard gooseneck trailers
- Includes spring-loaded safety chain loops and grade 8 hardware
- Protected by a highly durable carbide powder coat finish
- Patent#: 5,571,270; 5,755,452; 5,435,585
- Informative, full-color retail packaging
- Limited lifetime warranty

Installation brackets required.
See guide on page 289



61052

Pkg#	Plate Size	Ball Size	Finish	GTW / Vertical Load
61052	12" x 14"	2 5/16"	Carbide	30,000 / 7,500 lbs.

30k

GTW

OVER-BED FIXED BALL GOOSENECK HITCH

- Reinforcement required to reach max gross trailer weight rating
- Safety chain hook-ups sold separately
- Protected by a highly durable carbide powder coat finish

Installation brackets required.
See guide on page 289



61100

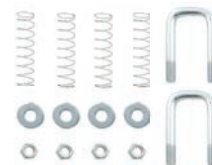

66113

Part#	Description	Plate Size	Ball Size	Finish	GTW / Vertical Load
61100	Flat plate with fixed trailer ball	12" x 12"	2 5/16"	Carbide	30,000 / 7,500 lbs.
66113	Safety chain U-bolt kit	--	--	--	--

30k

GTW

OVER-BED FLAT PLATE GOOSENECK HITCH

- Reinforcement required to reach max gross trailer weight rating
- Flat plate with fixed trailer ball and two 1/2" forged D-rings
- Protected by a highly durable carbide powder coat finish

Installation brackets required.
See guide on page 289



65500

Part#	Plate Size	Ball Size	Finish	GTW / Vertical Load
65500	13" x 48"	2 5/16"	Carbide	30,000 / 7,500 lbs.

30k
GTW

OVER-BED GOOSENECK APPLICATION GUIDE

- Up to 30,000 lbs. GTW (limited to vehicle capacities)
- Vehicle-specific design optimizes strength and installation time
- Constructed from high-strength, laser-cut steel for a precise fit
- Protected by a rust-resistant liquid Bonderite® coating
- Includes grade 8 mounting hardware



61301

Make / Model	Style	Years	Bracket#	Foot Notes
Chevrolet / GMC				
C/K Series 1500	Long bed	88 - 98	61503	--
	Short bed	88 - 98	61504	--
Silverado / Sierra 1500	--	07 - 18	61331	--
	Classic body	99 - 07	61341	●
Silverado / Sierra 1500 / 1500 HD Classic	--	07 - 07	61331	--
C/K Series 2500 / 3500	Long bed, old body	88 - 00	61503	--
	Short bed, old body	88 - 00	61504	--
Silverado / Sierra 2500 HD / 3500	--	11 - 18	61301	●
	--	01 - 10	61341	●
Silverado / Sierra 2500 LD	Classic body	99 - 07	61341	●
Dodge				
Ram 1500	--	02 - 08	61319	●
	--	94 - 01	61509	--
Ram 2500 / 3500	--	03 - 10	61529	--
	--	94 - 02	61509	--
Ford				
F-150	--	04 - 13	61321	●
	--	97 - 03	61506	--
	--	80 - 96	61505	--
	Heritage Edition	04 - 04	61506	--
F-250	Old body	97 - 98	61505	--
	--	80 - 96	61505	--
F-350	--	97 - 98	61505	--
	--	80 - 96	61505	--
F-250 / F-350 Super Duty	--	99 - 16	61332	●
F-450 Super Duty	Excluding cab & chassis	08 - 11	61332	●
Ram				
2500 / 3500	--	11 - 12	61529	--
Universal				
Universal rail kit	Raw finish	--	61502	--

● = No frame drilling required

WELD-ON GOOSENECK BALL

- Constructed from high-strength, ready-to-weld steel alloy
- Heat-treated for optimum strength and durability
- Tested for safety to meet U.S. VESC V-5 specifications



40094

Part#	Ball Size	GTW	Fits
40094	2 5/16"	30,000 lbs	2 5/16" gooseneck couplers

USING EXISTING 5TH WHEEL RAILS

25k

GTW

5TH WHEEL RAIL GOOSENECK HITCHES

- Allows pickup trucks equipped with 5th wheel rails to tow gooseneck trailers
- Mounts to all industry-standard 5th wheel rails
- Four-pin installation and removal for easy truck bed access
- Features a welded 2 5/16" trailer ball
- #16055 can be positioned over the axle or flipped to provide a 3" rearward offset
- Includes safety chain hookups, pins & clips
- Protected by a durable carbide powder coat finish
- Tested for safety in accordance with SAE J2638
- Informative, full-color retail packaging

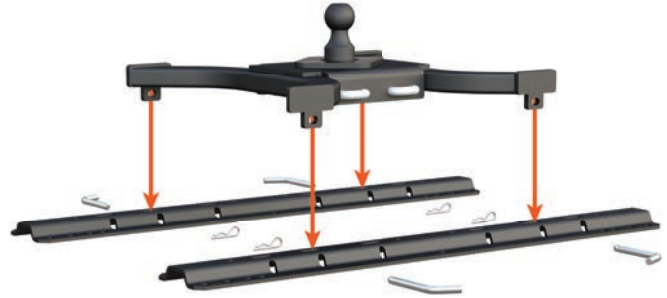

Pkg#	Description	Ball Size	Finish	GTW
16085	Spyder gooseneck hitch	2 5/16"	Carbide	25,000 lbs.
16055	Bent plate gooseneck hitch with 3" offset	2 5/16"	Carbide	25,000 lbs.
16902	Replacement rail pins & clips	--	Yellow zinc	--

CUSTOM 5TH WHEEL BRACKETS

See page 302 to select custom brackets

CURT custom brackets are designed to bolt onto the vehicle's frame and provide a set of permanent base rails in the truck bed to mount a 5th wheel hitch. Each set of brackets is designed to fit a specific vehicle application.

- Provides a solid mounting point for 5th wheel base rails and a 5th wheel hitch
- Brackets designed to be used in combination with CURT base rails #16104 or #16204
- Vehicle-specific application reduces or eliminates drilling to cut installation time in half
- Protected by a rust-resistant liquid Bonderite® coating
- Includes mounting hardware



GOOSENECK ELECTRICAL



CUSTOM WIRING HARNESS EXTENSIONS

- Routes a 7-way RV blade socket into truck bed while retaining use of rear socket
- Simple plug-and-play design eliminates the need for cutting or splicing
- Neoprene well nuts isolate steel bolts from aluminum surfaces (#57007)
- See page 250 for more information



Right-angle plug for easy installation



7-WAY RV BLADE EXTENSION

- Routes existing 7-way RV blade socket into full-size pickup truck bed (7' length)
- Universal size fits any 7-way RV blade socket
- Allows for easy connection of 5th wheel or gooseneck wiring
- See page 251 for more information



REPLACEMENT 7-WAY RV BLADE HARNESSES

- Replaces the trailer-end plug of any 7-way harness
- Wires protected by heavy-duty, weather-resistant cable
- Cold-weather harnesses feature soft thermoplastic elastomer casing to remain flexible in cold temperatures (temperature rating from -40°F up to 221°F)
- See page 251 for more information



BRAKE CONTROLS

- Equipped with quick plugs for fast, easy installation
- Easily calibrated for all towing needs
- See page 238 for our complete brake control line

NEW



51170

NEW



51160

Name	Retail Pkg#	Six-Pack#	Repl. Bracket#	Axles / Brakes	Activation Method	Display	Vertical Mount Angle	Level Adjust	Warranty
Spectrum™	51170 NEW	--	--	1 - 4 / 2 - 8	Tri-axis inertia	Tri-color LED	Any	Auto	Limited Lifetime
Assure™	51160 NEW	--	--	1 - 4 / 2 - 8	Tri-axis inertia	Dot matrix	Any	Auto	Limited Lifetime
TriFlex™	51140	51142	51144	1 - 4 / 2 - 8	Tri-axis inertia	Digital	-20° to +70°	Auto	Limited Lifetime
Relfex™	51130	51132	--	1 - 4 / 2 - 8	Dual-axis inertia	Digital	Any	Auto	Limited Lifetime
Venturer™	51120	51122	51124	1 - 4 / 2 - 8	Time-based	Digital	Any	Auto	Limited Lifetime
Discovery™	51110	--	51114	1 - 3 / 2 - 6	Time-based	LED	Any	Auto	Limited Lifetime



5TH WHEEL HITCHES

TESTED FOR ADVENTURE

CURT 5th wheel towing products offer the superior towing power and stable ride your customers need to Bring It®. New for 2018, we have added a GM puck system roller adapter and several new kitted options for our existing 5th wheel hitches. We have also introduced a new 5th wheel hitch base rail lock. CURT hitches are available in capacities of 16K to 25K and with a range of mounting options. See page 296 for a helpful hitch selection guide.

FEATURED PRODUCTS



A25 5th wheel hitch

The A25 is our best 5th wheel yet, featuring a 25K rating, a patented head design, a self-resetting handle and an easier-than-ever setup.



5th wheel hitch lock

This industry-first lock is specially designed to deter 5th wheel hitch theft, featuring a unique, flush-mount body and extra-long pin.



OEM puck system products

OEM puck system legs and roller products streamline 5th wheel towing and are available for Chevy, Ford, GMC, Nissan and Ram.

PRODUCT INDEX



296
Mounting a
5th Wheel Hitch



298
Puck System
Legs



300
Puck System
Roller Products



301
Roller
Units



302
Brackets
& Base Rails



305
X5 Adapter
Plate



306
A-Series
5th Wheels



308
Q-Series
5th Wheels



310
E-Series
5th Wheels



311
5th Wheel
Accessories



313
5th Wheel
Electrical

5TH WHEEL HITCHES

CURT 5th wheel hitches are designed for versatile application, and each one is compatible with a variety of mounting options. **For a helpful guide in selecting a 5th wheel hitch, see page 296.**



A-SERIES

The A-series is named for its articulating head design. The head is built on a patented cast yoke that offers a stable, quiet ride, even with large 5th wheel trailers. This cast yoke also features torsion springs and poly-torsion inserts to support the head and add even more stability to the connection.

- Lockable, self-resetting handle for fewer steps while coupling
- One-pin head attachment for easy removal and relocation
- High-strength interlocking jaws to add security and reduce noise
- Compatible with Sidewinder™ pin boxes (see page 311)

See page 306 for all A-series features and benefits



Q-SERIES

The Q-series is designed to offer the quietest towing possible. It features a spherical axial bearing that allows the head to tilt in any direction needed to ensure a smooth ride. The head is also equipped with three grease fittings for continuous lubrication and thick rubber stoppers to cushion the head.

- Lockable, short-throw, single-handle operation
- Self-aligning head offers a wide opening for easy coupling
- Dual jaws provide 360° kingpin contact to resist chucking noises

See page 308 for all Q-series features and benefits



E-SERIES

The E-series is designed to be a more economical option for our budget-conscious customers. The E-series operates on a dual-pivoting head that provides 10° of lateral movement for smooth towing. The head also features an anti-rattle skid plate with rubber stoppers to help promote a quiet ride.

- Easy, single-handle operation
- Automatic locking mechanism for simple, secure coupling
- Four height adjustment positions to adapt to each unique truck bed
- Compatible with Sidewinder™ pin boxes (see page 311)

See page 310 for all E-series features and benefits

QUICK COMPARISON

Feature	A-Series	Q-Series	E-Series
Pivoting Mechanism	Cast yoke with two pivot points	Spherical axial bearing	10° dual-pivoting head
Handle Operation	Single-throw, self-resetting handle	Short-throw, single handle	Single handle
Head Opening	Extra wide, self-aligning	Extra wide, self-aligning	Self-aligning
Jaw Type	Dual, interlocking	Dual	Locking bar
Coupling Indicator	Yes	Yes	No
Head Removal	One-pin	Two-pin	Two-pin
Sidewinder™ Compatible	Yes (wedge required)	No	Yes (wedge required)
GTW Options	16K, 20K, 25K	20K, 24K, 25K	16K
Warranty	Limited lifetime	Ten-year	Five-year

5TH WHEEL MOUNTING OPTIONS

OEM Puck System Products

Puck system legs and roller products use a simple quarter-turn anchor system to easily and securely drop into the truck bed pucks built into many pickups today.

- Options available for Ford, GM, Nissan and Ram
- Compatible with most CURT 5th wheel hitches
- **See page 298 for long-bed options and 300 for short-bed options**



5th Wheel Rollers

CURT 5th wheel rollers are true rolling units, operating on solid rods and wheels to resist binding. They add 12" of clearance when making tight turns.

- Adds turning clearance for short-bed trucks
- Available in 16K, 20K and 24K capacities
- **See page 301 for full features and benefits**



Custom Under-Bed Brackets

Each designed to fit a specific vehicle application, our custom brackets install in less time and provide a solid mount for our industry-standard base rails.

- Vehicle-specific fit reduces or eliminates drilling
- Protected by a rust-resistant liquid Bonderite® coating
- **See page 302 for application information**



Industry-Standard Base Rails

CURT industry-standard base rails accept any CURT 5th wheel legs or roller, as well as any competitor 5th wheel with industry-standard mounting points.

- Gloss black or carbide black powder coat finish
- Co-cured in a rust-resistant liquid Bonderite® coating
- **See page 302 for application information**



X5 Adapter Plates

X5 adapter plates allow a gooseneck hitch to become a 5th wheel mount. They drop into the gooseneck hole and provide a set of industry-standard base rails.

- Available for EZr™, Double Lock and competitor models
- Compatible with CURT 5th wheels up to 20,000 lbs.
- **See page 305 for full features and benefits**



5th Wheel Accessories

We offer a number of accessories to help improve 5th wheel operation and safety while towing, including 5th wheel wedges and more.

- Lube plates and sound pads for smooth operation
- Safety chain loops and electrical for improved safety
- **See page 311 for all 5th wheel accessories**



MOUNTING A 5TH WHEEL HITCH

There are several components that make up a 5th wheel hitch, and these components are determined by truck type and customer preferences. Answer the following questions to help choose the right hitch for your customer.

What size is the truck bed?

The length of the truck bed will determine which type of mounting platform the 5th wheel hitch requires: legs or a roller. **Note: A roller may be required for long-bed trucks. Review each configuration before purchase.**

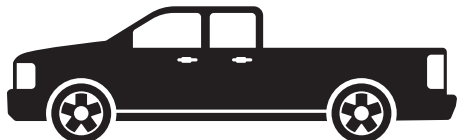

LONG-BED

5th wheel legs are the standard 5th wheel mounting method. A long-bed truck will provide the necessary room for this option.

For long-bed trucks, follow the orange path.



SHORT-BED

A 5th wheel roller is recommended on short-bed trucks. A roller adds clearance between the cab and the trailer when turning.

For short-bed trucks, follow the blue path.

A | OEM PUCK SYSTEM OPTIONS

Many trucks today, specifically from Ford, GM, Nissan and Ram, come with a built-in mounting platform in the bed called a puck system. A puck system makes installing a CURT 5th wheel hitch very easy.

If the truck does not have a puck system, continue to page 302 for rail system options.

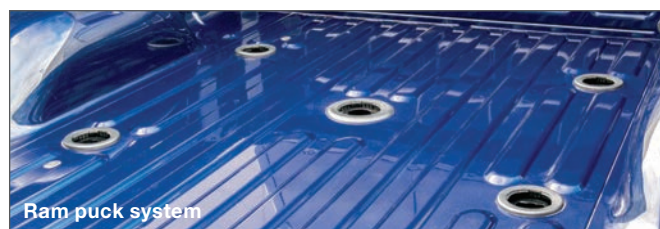

LONG-BED WITH OEM PUCK SYSTEM

If the long bed has a puck system, select a 5th wheel hitch with OEM puck system legs.

See page 298 for our complete kits.



SHORT-BED WITH OEM PUCK SYSTEM

If the short bed has a puck system, select an OEM puck system roller to mount the 5th wheel hitch.

See page 300 for our available roller options.

B | PERMANENT RAIL SYSTEMS

If your customer prefers fixed rails in the truck bed, select a vehicle-specific, under-bed bracket kit and corresponding base rails to mount the 5th wheel hitch.

LONG-BED

1. See page 303 for available bracket applications.
2. See page 302 for corresponding base rails.
3. Select a 5th wheel hitch from the 'Long-Bed Options' starting on page 307.

3. 5th wheel with legs



2. Above-bed base rails



1. Custom under-bed brackets



SHORT-BED

1. See page 303 for available bracket applications.
2. See page 302 for corresponding base rails.
3. Select a 5th wheel hitch from the 'Short-Bed Options' starting on page 307.

3. 5th wheel with roller



2. Above-bed base rails



1. Custom under-bed brackets



C | REMOVABLE RAIL SYSTEMS

If your customer prefers the option of easily removing the base rails for an unobstructed truck bed, select a gooseneck hitch kit and an X5 adapter plate to mount the 5th wheel hitch.

LONG-BED

1. See page 273 for available gooseneck hitches.
2. See page 305 for a corresponding X5 adapter.
3. Select a 5th wheel hitch from the 'Long-Bed Options' starting on page 307.

3. 5th wheel with legs



2. Above-bed X5 adapter



1. Under-bed gooseneck hitch kit



SHORT-BED

1. See page 273 for available gooseneck hitches.
2. See page 305 for a corresponding X5 adapter.
3. Select a 5th wheel hitch from the 'Short-Bed Options' starting on page 307.

3. 5th wheel with roller



2. Above-bed X5 adapter

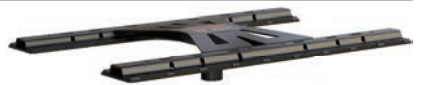

1. Under-bed gooseneck hitch kit



PUCK SYSTEMS FOR **LONG-BED**

OEM PUCK SYSTEM 5TH WHEEL HITCH KITS

5th wheel kits are available for Ford, GM, Nissan Titan XD and Ram trucks with the OEM puck system. These kits come with puck system legs and are designed to fit long-bed trucks. For short-bed trucks with the puck system, a 5th wheel roller will be needed.

See page 300 for our OEM puck system 5th wheel roller products.

How OEM puck system legs work



Step 1 - Drop legs into the truck bed puck system



Step 2 - Close the anchor levers to lock legs into place

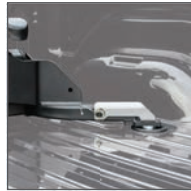

Step 3 - Secure levers with attached safety pins



Ram legs installed in a long-bed truck with Q20 head (16045)

Product Details

- Legs allow CURT 5th wheel hitches to fit the OEM puck system
- Quarter-turn anchors allow for quick installation and removal
- Anchors can be adjusted to eliminate chocking between the legs and under-bed platform
- Protected by a durable carbide powder coat finish



16069 - GM legs with Q25 head

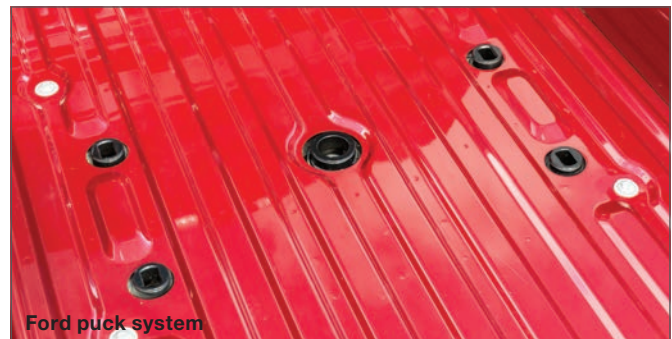

Ford puck system

Installation of these products requires an OEM truck bed puck system



16034 - Ford legs with A20 head



16049 - Ram legs with Q25 head



16074 - Nissan legs with A20 head

Step 1 - Verify vehicle make and puck system compatibility

Step 2 - Determine the weight capacity required

Step 3 - Select a 5th wheel kit. See comparison on page 294

Kit#	GTW / Vertical Load	5th Wheel Head	OEM Puck System Legs	Height	Warranty
Chevrolet / GMC					
16063	16,000 lbs. / 4,000 lbs.	A16 head (16520)	Chevrolet / GMC legs (16025)	13" - 17"	Limited lifetime
16061	16,000 lbs. / 4,000 lbs.	E16 head (16515)	Chevrolet / GMC legs (16025)	11 1/2" - 13 1/2"	Five-year limited
16064	20,000 lbs. / 5,000 lbs.	A20 head (16540)	Chevrolet / GMC legs (16025)	13" - 17"	Limited lifetime
16065	20,000 lbs. / 5,000 lbs.	Q20 head (16530)	Chevrolet / GMC legs (16025)	13" - 17"	Ten-year limited
16067	24,000 lbs. / 6,000 lbs.	Q24 head (16545)	Chevrolet / GMC legs (16025)	13" - 17"	Ten-year limited
16066	25,000 lbs. / 6,250 lbs.	A25 head (16580)	Chevrolet / GMC legs (16025)	13" - 17"	Limited lifetime
16069	25,000 lbs. / 6,250 lbs.	Q25 head (16565)	Chevrolet / GMC legs (16025)	13" - 17"	Ten-year limited
Ford					
16033	16,000 lbs. / 4,000 lbs.	A16 head (16520)	Ford legs (16017)	13" - 17"	Limited lifetime
16031	16,000 lbs. / 4,000 lbs.	E16 head (16515)	Ford legs (16017)	11 1/2" - 13 1/2"	Five-year limited
16034	20,000 lbs. / 5,000 lbs.	A20 head (16540)	Ford legs (16017)	13" - 17"	Limited lifetime
16035	20,000 lbs. / 5,000 lbs.	Q20 head (16530)	Ford legs (16017)	13" - 17"	Ten-year limited
16037	24,000 lbs. / 6,000 lbs.	Q24 head (16545)	Ford legs (16017)	13" - 17"	Ten-year limited
16036	24,000 lbs. / 6,000 lbs.	A25 head (16580)	Ford legs (16017)	13" - 17"	Limited lifetime
Nissan Titan XD					
16073	16,000 lbs. / 4,000 lbs.	A16 head (16520)	Nissan Titan XD legs (16026)	13" - 17"	Limited lifetime
16071	16,000 lbs. / 4,000 lbs.	E16 head (16515)	Nissan Titan XD legs (16026)	11 1/2" - 13 1/2"	Five-year limited
16074	20,000 lbs. / 5,000 lbs.	A20 head (16540)	Nissan Titan XD legs (16026)	13" - 17"	Limited lifetime
16075	20,000 lbs. / 5,000 lbs.	Q20 head (16530)	Nissan Titan XD legs (16026)	13" - 17"	Ten-year limited
Ram					
16043	16,000 lbs. / 4,000 lbs.	A16 head (16520)	Ram legs (16021)	14" - 18"	Limited lifetime
16041	16,000 lbs. / 4,000 lbs.	E16 head (16515)	Ram legs (16021)	12 1/2" - 15 1/2"	Five-year limited
16044	20,000 lbs. / 5,000 lbs.	A20 head (16540)	Ram legs (16021)	14" - 18"	Limited lifetime
16045	20,000 lbs. / 5,000 lbs.	Q20 head (16530)	Ram legs (16021)	14" - 18"	Ten-year limited
16047	24,000 lbs. / 6,000 lbs.	Q24 head (16545)	Ram legs (16021)	14" - 18"	Ten-year limited
16046	25,000 lbs. / 6,250 lbs.	A25 head (16580)	Ram legs (16021)	14" - 18"	Limited lifetime
16049	25,000 lbs. / 6,250 lbs.	Q25 head (16565)	Ram legs (16021)	14" - 18"	Ten-year limited

OEM PUCK SYSTEM 5TH WHEEL LEGS ONLY

- Legs allow CURT 5th wheel hitches to fit the OEM puck system
- Quarter-turn anchors allow for quick installation and removal
- Anchors can be adjusted to eliminate chocking between the legs and under-bed platform



Part#	Fits	GTW / Vertical Load	Warranty
16017	Ford	Up to 24,000 lbs.	Limited lifetime
16021	Ram	Up to 25,000 lbs.	Limited lifetime
16025	Chevrolet / GMC	Up to 25,000 lbs.	Limited lifetime
16026	Nissan Titan XD	Up to 20,000 lbs.	Limited lifetime

PUCK SYSTEMS FOR SHORT-BED

24K

GTW

OEM PUCK SYSTEM 5TH WHEEL ROLLER PRODUCTS

The 5th wheel roller products below are for short-bed trucks with the OEM puck system. The Ford option has a built-in roller unit and is designed to accept a CURT 5th wheel head. The Ram and GM options are designed to accept a CURT 5th wheel roller. **See the table on page 301 to select OEM puck system roller products.**

How OEM puck system rollers work



Step 1 - Drop OEM product into the truck bed puck system



Step 2 - Close the anchor levers to lock roller into place



Step 3 - Secure levers with attached safety pins



Chevrolet / GMC roller adapter installed in a short-bed truck with A20 head and R20 roller kit (16669)

Product Details

Ford roller system

- Adapts any CURT 5th wheel head unit to fit the Ford puck system
- Features integrated roller to provide added clearance for short-bed trucks

Chevrolet / GMC & Ram roller adapters

- Adapts any CURT 5th wheel roller to fit the OEM puck system
- Requires a 5th wheel roller unit to mount the 5th wheel hitch

All roller products

- Quarter-turn anchors allow for quick installation and removal
- Anchors can be adjusted to eliminate chocking between the roller and under-bed platform
- Tested for safety in accordance with SAE J2638
- Protected by a durable carbide powder coat finish
- Capacity limited to lowest-rated towing component



Part#	Make	GTW	Description	Notes	Finish
16020	Ford	Up to 24,000 lbs.	OEM roller system (roller built in)	Hitch head sold separately	Carbide
16022	Ram	Up to 24,000 lbs.	OEM roller adapter legs	Hitch head and roller sold separately	Carbide
16023 NEW	Chevrolet / GMC	Up to 20,000 lbs.	OEM roller adapter legs	Hitch head and roller sold separately	Carbide

Step 1 - Verify vehicle make and puck system compatibility

Step 2 - Determine the weight capacity required

Step 3 - Select a 5th wheel kit. See comparison on page 294

Kit#		GTW / Vertical Load	5th Wheel Head & Roller Kits	OEM Puck System Product	Height	Limited Warranty
Chevrolet / GMC						
16667	NEW	16,000 / 4,000 lbs.	E16 head with R16 roller (16561)	Chev / GMC roller adapter (16023)	16" - 19"	Five-year
16668	NEW	16,000 / 4,000 lbs.	A16 head with R16 roller (16521)	Chev / GMC roller adapter (16023)	19" - 23"	Lifetime
16669	NEW	20,000 / 5,000 lbs.	A20 head with R20 roller (16541)	Chev / GMC roller adapter (16023)	19" - 23"	Lifetime
16671	NEW	20,000 / 5,000 lbs.	Q20 head with R20 roller (16536)	Chev / GMC roller adapter (16023)	19" - 23"	Ten-year
Ford						
16674	NEW	16,000 / 4,000 lbs.	E16 head (16515)	Ford roller (16020)	14" - 18"	Five-year
16675	NEW	16,000 / 4,000 lbs.	A16 head (16520)	Ford roller (16020)	17 1/2" - 21 1/2"	Lifetime
16676	NEW	20,000 / 5,000 lbs.	A20 head (16540)	Ford roller (16020)	17 1/2" - 21 1/2"	Lifetime
16677	NEW	20,000 / 5,000 lbs.	Q20 head (16530)	Ford roller (16020)	17 1/2" - 21 1/2"	Ten-year
16678	NEW	24,000 / 6,000 lbs.	Q24 head (16545)	Ford roller (16020)	17 1/2" - 21 1/2"	Ten-year
Ram						
16684	NEW	16,000 / 4,000 lbs.	E16 head with R16 roller (16561)	Ram roller adapter (16022)	16" - 19"	Five-year
16685	NEW	16,000 / 4,000 lbs.	A16 head with R16 roller (16521)	Ram roller adapter (16022)	19" - 23"	Lifetime
16686	NEW	20,000 / 5,000 lbs.	A20 head with R20 roller (16541)	Ram roller adapter (16022)	19" - 23"	Lifetime
16687	NEW	20,000 / 5,000 lbs.	Q20 head with R20 roller (16536)	Ram roller adapter (16022)	19" - 23"	Ten-year
16688	NEW	24,000 / 6,000 lbs.	Q24 head with R24 roller (16546)	Ram roller adapter (16022)	19" - 23"	Ten-year

5TH WHEEL ROLLERS ONLY

For short-bed trucks, a 5th wheel roller is used in place of 5th wheel legs to provide the extra clearance needed to make tight turns. A roller allows the hitch to slide backward several inches, allowing the truck and trailer to turn safely.

See our complete roller kits under the 'Short-Bed Options' table, starting on page 307.

Product Details

- Constructed with solid, non-binding rods that lock the hitch into position
- Designed to be a true rolling unit, not just a slider
- Provides 12" of travel
- Uses wheels to bear the weight
- Protected by a highly durable carbide powder coat finish

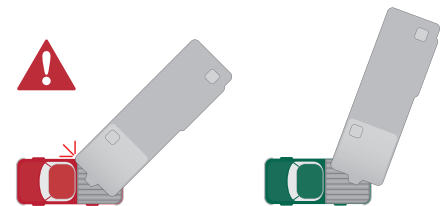

Pkg#	Description	GTW	Warranty	Finish
16560	R16 5th wheel roller unit	16,000 lbs.	Five-year limited	Carbide
16550	R20 5th wheel roller unit	20,000 lbs.	Ten-year limited	Carbide
16570	R24 5th wheel roller unit	24,000 lbs.	Ten-year limited	Carbide

PERMANENT RAIL SYSTEMS

CUSTOM UNDER-BED BRACKETS & INDUSTRY-STANDARD BASE RAILS

Custom brackets provide a set of permanent 5th wheel base rails in the truck bed. If your customer prefers removable rails for no obstructions in the truck bed, [see page 305 for our gooseneck adapter options.](#)

Custom brackets

- Designed to be used in combination with CURT base rails #16104 or #16204
- Vehicle-specific application reduces or eliminates drilling to cut installation time in half
- Protected by a rust-resistant liquid Bonderite® coating
- Includes mounting hardware



16400 brackets shown with 16204 base rails

Semi-custom brackets

- Designed to be used in combination with CURT universal brackets and base rails #16100 or #16200
- All semi-custom brackets require drilling to be installed

Step 1 - Pick vehicle-specific brackets starting on page 303

Step 2 - Select the base rails by finish preference

Step 3 - Start on page 294 to select a 5th wheel hitch

UNIVERSAL UNDER-BED BRACKETS & INDUSTRY-STANDARD BASE RAILS

- Intended for vehicle applications not covered by CURT custom brackets
- Compatible with CURT and most competitive 5th wheel hitches, rollers and gooseneck adapters
- All universal brackets require drilling to be installed



16104 gloss rails
16204 carbide rails
16101 brackets

Part#	Multi-Pack#	Finish	Description	Includes
5th Wheel Brackets and Base Rails				
16150	--	Gloss black	Two 5th wheel base rails, four-bolt	Brackets and hardware
16100	--	Gloss black	Two 5th wheel base rails, 10-bolt	Brackets and hardware (16101)
16200	--	Carbide	Two 5th wheel base rails, 10-bolt	Brackets and hardware (16101)
5th Wheel Base Rails Only				
16104	--	Gloss black	Two 5th wheel base rails, 10-bolt	--
16204	--	Carbide	Two 5th wheel base rails, 10-bolt	--
Replacement Parts				
16101	--	Zinc-plated	Installation brackets and hardware	--
16111	--	Zinc-plated	Replacement installation hardware kit	--
16103	16103010	Zinc-plated	Replacement bracket bolts, needed when installing new brackets	16103 - eight bolts 16103010 - 10 sets of eight bolts

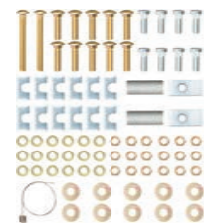

16111



16103

CUSTOM UNDER-BED BRACKETS APPLICATION GUIDE

Make / Model	Style	Years	Bracket Type	Bracket#	Foot Notes	Carbide Black Rail#	Gloss Black Rail#
Chevrolet							
Silverado 1500	--	07 - 18	Custom	16400	●	16204	16104
	Classic body	99 - 07	Custom	16418	Drill	16204	16104
Silverado 1500 Classic	--	07 - 07	Custom	16400	●	16204	16104
Silverado 1500 HD Classic	--	07 - 07	Custom	16400	●	16204	16104
Silverado 2500	--	99 - 04	Custom	16418	Drill	16204	16104
Silverado 2500 HD Classic	--	07 - 07	Custom	16418	Drill	16204	16104
Silverado 2500 HD	High Country	15 - 18	Custom	16411	●	16204	16104
	LT, LTZ, WT	11 - 18	Custom	16411	●	16204	16104
	--	01 - 10	Custom	16418	Drill	16204	16104
Silverado 3500	--	01 - 06	Custom	16418	Drill	16204	16104
Silverado 3500 Classic	--	07 - 07	Custom	16418	Drill	16204	16104
Silverado 3500 HD	High Country	15 - 18	Custom	16411	●	16204	16104
	LT, LTZ, WT	11 - 18	Custom	16411	●	16204	16104
	--	07 - 10	Custom	16418	Drill	16204	16104
Dodge							
Ram 1500	Excluding Crew cab	09 - 10	Custom	16422	Drill	16204	16104
	Mega cab	06 - 08	Custom	16420	●	16204	16104
	Excluding Mega cab	02 - 08	Custom	16419	●	16204	16104
	Excluding factory air suspension	09 - 10	Custom	16306	Drill	16204	16104
	--	02 - 08	Semi-custom	16303	Drill	16200	16100
Ram 2500 / 3500	--	03 - 10	Custom	16420	●	16204	16104
	--	03 - 10	Semi-custom	16301	Drill	16200	16100
Ford							
F-150	King Ranch, Lariat, Platinum, XL, XLT	15 - 18	Custom	16442	●	16204	16104
	Limited, SSV	16 - 18	Custom	16442	●	16204	16104
	Raptor	17 - 18	Custom	16442	●	16204	16104
	6.5' and 8' beds	04 - 14	Custom	16441	●	16204	16104
	--	97 - 03	Custom	16437	●	16204	16104
	Excluding Heritage Edition	04 - 11	Custom	16300	Drill	16204	16104
F-150 Heritage Edition	Heritage Edition	04 - 04	Custom	16437	●	16204	16104
F-250LD	New body	97 - 03	Custom	16437	●	16204	16104
F-250 Super Duty	King Ranch, Lariat, Platinum, XL, XLT	17 - 18	Custom	16428	●	16204	16104
	--	11 - 16	Custom	16424	●	16204	16104
	--	05 - 10	Custom	16448	Drill	16204	16104
	--	99 - 04	Custom	16443	Drill	16204	16104
F-350 Super Duty	King Ranch, Lariat, Platinum, XL, XLT	17 - 18	Custom	16428	●	16204	16104
	--	11 - 16	Custom	16424	●	16204	16104
	--	05 - 10	Custom	16448	Drill	16204	16104
	--	99 - 04	Custom	16443	Drill	16204	16104
F-450 Super Duty	Crew cab	17 - 17	Custom	16428	●	16204	16104
	Excluding cab & chassis	11 - 15	Custom	16424	●	16204	16104
		08 - 10	Custom	16448	Drill	16204	16104

● = No drill

Applications continued on the following page

CUSTOM UNDER-BED BRACKETS APPLICATION GUIDE (CONTINUED)

Make / Model	Style	Years	Bracket Type	Bracket#	Foot Notes	Carbide Black Rail#	Gloss Black Rail#
GMC							
Sierra 1500	--	07 - 18	Custom	16400	●	16204	16104
	Classic body	99 - 07	Custom	16418	Drill	16204	16104
Sierra 1500 Classic	--	07 - 07	Custom	16400	●	16204	16104
Sierra 1500 HD Classic	--	07 - 07	Custom	16400	●	16204	16104
Sierra 2500	--	99 - 04	Custom	16418	Drill	16204	16104
Sierra 2500 HD Classic	--	07 - 07	Custom	16418	Drill	16204	16104
Sierra 2500 HD	Base	15 - 18	Custom	16411	●	16204	16104
	Denali, SLE, SLT	11 - 18	Custom	16411	●	16204	16104
	WT	11 - 14	Custom	16411	●	16204	16104
	--	01 - 10	Custom	16418	Drill	16204	16104
Sierra 3500	--	01 - 06	Custom	16418	Drill	16204	16104
Sierra 3500 Classic	--	07 - 07	Custom	16418	Drill	16204	16104
Sierra 3500 HD	Base	15 - 18	Custom	16411	●	16204	16104
	Denali, SLE, SLT	11 - 18	Custom	16411	●	16204	16104
	WT	11 - 14	Custom	16411	●	16204	16104
	--	07 - 10	Custom	16418	Drill	16204	16104
Nissan							
Titan	--	17 - 17	Custom	16470	Drill	16204	16104
		04 - 15	Custom	16470	Drill	16204	16104
Ram							
1500	With factory air suspension	13 - 17	Custom	16444	Drill	16204	16104
	Excluding factory air suspension	11 - 17	Custom	16306	Drill	16204	16104
2500	Without factory prep package	14 - 17	Custom	16427	●	16204	16104
		13 - 13	Custom	16426	●	16204	16104
		11 - 12	Custom	16420	●	16204	16104
		11 - 12	Semi-custom	16301	Drill	16200	16100
3500	--	13 - 17	Custom	16426	●	16204	16104
		11 - 12	Custom	16420	●	16204	16104
		11 - 12	Semi-custom	16301	Drill	16200	16100
Toyota							
Tundra	Base, crew cab pickup, 6.5' bed	08 - 13	Custom	16468	Drill	16204	16104
	Base, standard cab pickup, 6.5' bed	07 - 13	Custom	16468	Drill	16204	16104
	Limited, crew cab pickup, 6.5' bed	07 - 18	Custom	16468	Drill	16204	16104
	SR, crew cab pickup, 6.5' bed	14 - 18	Custom	16468	Drill	16204	16104
	SR, standard cab pickup, 6.5' bed	14 - 17	Custom	16468	Drill	16204	16104
	SR5, crew cab pickup, 6.5' bed	14 - 18	Custom	16468	Drill	16204	16104
	SR5, crew cab pickup, 6.5' bed	07 - 11	Custom	16468	Drill	16204	16104
	TRD Pro, crew cab pickup, 6.5' bed	15 - 17	Custom	16468	Drill	16204	16104
	Strd. cab / ext. crew cab, 6' 5" bed	07 - 16	Semi-custom	16304	Drill	16200	16100
	Strd. cab cab / ext. crew cab, 8' bed	07 - 16	Semi-custom	16304	Drill	16200	16100
	Standard cab, 8' bed	00 - 06	Semi-custom	16302	Drill	16200	16100
		00 - 06	Custom	16465	●	16204	16104

● = No drill

REMOVABLE RAIL SYSTEMS

20k
GTW

X5 GOOSENECK TO 5TH WHEEL ADAPTER PLATES

The X5 adapter plate allows a gooseneck hitch to become a mounting platform for a 5th wheel hitch. The X5 shank simply drops into the gooseneck ball hole and instantly provides a set of industry-standard 5th wheel base rails.

See the table below for gooseneck hitch compatibility.

Product Details

- Converts a gooseneck hitch into a set of standard 5th wheel base rails
- Simple, secure design allows for fast installation and removal as needed
- For use with CURT and competitive 5th wheels up to 20,000 lbs.
- Capacity limited to lowest-rated towing component
- Accepts any standard CURT 5th wheel legs or roller (excludes OEM puck system)
- Protected by a durable carbide powder coat finish
- Co-cured in a rust-resistant liquid Bonderite® coating
- **Not compatible with OEM-style gooseneck hitches**
- **Not compatible with Sidewinder™ pin boxes**
(Trademark of Cequent Consumer Products™)



Step 1 - Pick a gooseneck hitch. If your customer has a gooseneck hitch, see step 2

Step 2 - Select the corresponding X5 adapter plate to match the gooseneck

Step 3 - See page 294 for our 5th wheel hitch selection guide



Part#	Fits	Capacity	Shank Style
16210	CURT Double Lock 60607, 60615, 60620, 60625	20,000 lbs.	Round shank
16220	CURT Double Lock EZr™ 60611 and 60619	20,000 lbs.	Round shank
16310	B&W Turnoverball® gooseneck hitch (does not work with shallow models)	20,000 lbs.	Square shank

See page 278 for original Double Lock gooseneck hitches. See page 282 for Double Lock EZr™ gooseneck hitches

A-SERIES HITCHES

See page 294 for A, Q and E-series hitch comparisons

16k GTW A16 HITCH



16120

20k GTW A20 HITCH



16140

25k GTW A25 HITCH



16180

Product Details

- GTW capacities up to 16,000, 20,000 and 25,000 lbs.
- Weight ratings are limited to vehicle manufacturer's stated capacities
- High-strength, interlocking cast jaws fully wrap the kingpin to minimize noise
- Extra wide head opening for easier coupling
- Constructed with a cast steel main body for a more precise build (A25 only)
- Offers three height adjustment positions to adapt to each unique truck bed
- Fast, one-pin head removal makes moving easy with smaller, lighter pieces
- Compatible with kingpin extension boxes, including common pivoting pin boxes (see page 311 for 5th wheel wedges)
- Includes a polyethylene lube plate to eliminate messy grease deposits
- Protected by a highly durable carbide powder coat finish
- Tested for safety in accordance with SAE J2638
- Patent# 8,827,298
- Limited lifetime warranty

Product Features



Lockable handle self-resets to the ready-to-couple position after the hitch is uncoupled



Fully articulating torsion head for controlled coupling and a stable, quiet ride



Alignment pegs and easy-access mounting bolts for simple leg-to-body attachment (A20 & A25 only)



Cast yoke and poly-torsion inserts suppress shock loads and reduce noise

Three-position coupling indicator



- UNCOUPLE** Jaws unlocked, ready to uncouple
- COUPLE** Jaws open, ready to couple
- TOW** Jaws locked, ready to tow

A-SERIES 5TH WHEEL HITCH OPTIONS

See page 296 for a hitch selection guide



16064



16669



16641

Part#	Description	GTW / Vertical Load	Height Range
Long-Bed Options			
16120	A16 5th wheel hitch	16,000 / 4,000 lbs.	13" - 17"
16121	A16 5th wheel hitch (16120) with base rails (16200)	16,000 / 4,000 lbs.	13" - 17"
16063	A16 head (16520) with Chevrolet / GMC puck system legs (16025)	16,000 / 4,000 lbs.	13" - 17"
16033	A16 head (16520) with Ford puck system legs (16017)	16,000 / 4,000 lbs.	13" - 17"
16073	A16 head (16520) with Nissan Titan XD puck system legs (16026)	16,000 / 4,000 lbs.	13" - 17"
16043	A16 head (16520) with Ram puck system legs (16021)	16,000 / 4,000 lbs.	14" - 18"
16140	A20 5th wheel hitch	20,000 / 5,000 lbs.	13" - 17"
16141	A20 5th wheel hitch (16140) with base rails (16200)	20,000 / 5,000 lbs.	13" - 17"
16064	A20 head (16540) with Chevrolet / GMC puck system legs (16025)	20,000 / 5,000 lbs.	13" - 17"
16034	A20 head (16540) with Ford puck system legs (16017)	20,000 / 5,000 lbs.	13" - 17"
16074	A20 head (16540) with Nissan Titan XD puck system legs (16026)	20,000 / 5,000 lbs.	13" - 17"
16044	A20 head (16540) with Ram puck system legs (16021)	20,000 / 5,000 lbs.	14" - 18"
16180	A25 5th wheel hitch	25,000 / 6,250 lbs.	13" - 17"
16181	A25 5th wheel hitch (16180) with base rails (16200)	25,000 / 6,250 lbs.	13" - 17"
16066	A25 head (16580) with Chevrolet / GMC puck system legs (16025)	25,000 / 6,250 lbs.	13" - 17"
16046	A25 head (16580) with Ram puck system legs (16021)	25,000 / 6,250 lbs.	14" - 18"
Short-Bed Options			
16521	A16 head (16520) with R16 roller (16560)	16,000 / 4,000 lbs.	17 1/2" - 21 1/2"
16621	A16 head with R16 roller (16521) and base rails (16200)	16,000 / 4,000 lbs.	17 1/2" - 21 1/2"
16668 NEW	A16 head with R16 roller (16521) & Chev / GMC puck system roller adapter (16023)	16,000 / 4,000 lbs.	19" - 23"
16675 NEW	A16 head (16520) & Ford puck system roller (16020)	16,000 / 4,000 lbs.	17 1/2" - 21 1/2"
16685 NEW	A16 head with R16 roller (16521) & Ram puck system roller adapter (16022)	16,000 / 4,000 lbs.	19" - 23"
16541	A20 head (16540) with R20 roller (16550)	20,000 / 5,000 lbs.	17 1/2" - 21 1/2"
16641	A20 head with R20 roller (16541) and base rails (16200)	20,000 / 5,000 lbs.	17 1/2" - 21 1/2"
16669 NEW	A20 head with R20 roller (16541) & Chev / GMC puck system roller adapter (16023)	20,000 / 5,000 lbs.	19" - 23"
16676 NEW	A20 head (16540) & Ford puck system roller (16020)	20,000 / 5,000 lbs.	17 1/2" - 21 1/2"
16686 NEW	A20 head with R20 roller (16541) & Ram puck system roller adapter (16022)	20,000 / 5,000 lbs.	19" - 23"
Individual Components			
16520	A16 head only	16,000 / 4,000 lbs.	--
16920	A16 replacement leg kit and hardware	--	--
16540	A20 head only	20,000 / 5,000 lbs.	--
16906	A20 replacement leg kit and hardware	--	--
16580	A25 head only	25,000 / 6,250 lbs.	--
16907	A25 replacement leg kit and hardware	--	--
16902	Replacement rail pins & clips	--	--

For a guide in selecting the right 5th wheel for your customer's vehicle, see page 296

Q-SERIES HITCHES

See page 294 for A, Q and E-series hitch comparisons

20K GTW Q20 HITCH



16130

24K GTW Q24 HITCH



16245

25K GTW Q25 HITCH



16265

Product Details

- GTW capacities up to 20,000, 24,000 and 25,000 lbs.
- Weight ratings are limited to vehicle manufacturer's stated capacities
- Three easy-access grease fittings for lubrication
- Offers three height adjustment positions to adapt to each unique truck bed
- Includes a polyethylene lube plate to eliminate messy grease deposits
- Protected by a highly durable carbide powder coat finish
- Tested for safety in accordance with SAE J2638
- Ten-year limited warranty

Product Features



Spherical axial bearing allows the head to tilt in any direction needed for a smooth ride



Dual jaws fully wrap the kingpin to reduce chucking noises and increase towing security



Wide, self-aligning head helps eliminate errors when backing up to the trailer for easier coupling



Lockable, short-throw handle automatically engages with the kingpin to simplify operation

Three-position coupling indicator



- UNCOUPLE** Jaws unlocked, ready to uncouple
- △ COUPLE** Jaws open, ready to couple
- TOW** Jaws locked, ready to tow

Q-SERIES 5TH WHEEL HITCH OPTIONS

See page 296 for a hitch selection guide



16037



16677



16646

Part#	Description	GTW / Vertical Load	Height Range
Long-Bed Options			
16130	Q20 5th wheel hitch	20,000 / 5,000 lbs.	13" - 17"
16131	Q20 5th wheel hitch (16130) with base rails (16200)	20,000 / 5,000 lbs.	13" - 17"
16065	Q20 head (16530) with Chevrolet / GMC puck system legs (16025)	20,000 / 5,000 lbs.	13" - 17"
16035	Q20 head (16530) with Ford puck system legs (16017)	20,000 / 5,000 lbs.	13" - 17"
16075	Q20 head (16530) with Nissan Titan XD puck system legs (16026)	20,000 / 5,000 lbs.	13" - 17"
16045	Q20 head (16530) with Ram puck system legs (16021)	20,000 / 5,000 lbs.	14" - 18"
16245	Q24 5th wheel hitch	24,000 / 6,000 lbs.	13" - 17"
16246	Q24 5th wheel hitch (16245) with base rails (16200)	24,000 / 6,000 lbs.	13" - 17"
16067	Q24 head (16545) with Chevrolet / GMC puck system legs (16025)	24,000 / 6,000 lbs.	13" - 17"
16037	Q24 head (16545) with Ford puck system legs (16017)	24,000 / 6,000 lbs.	13" - 17"
16047	Q24 head (16545) with Ram puck system legs (16021)	24,000 / 6,000 lbs.	14" - 18"
16265	Q25 5th wheel hitch	25,000 / 6,250 lbs.	13" - 17"
16266	Q25 5th wheel hitch (16265) with base rails (16200)	25,000 / 6,250 lbs.	13" - 17"
16069	Q25 head (16565) with Chevrolet / GMC puck system legs (16025)	25,000 / 6,250 lbs.	13" - 17"
16049	Q25 head (16565) with Ram puck system legs (16021)	25,000 / 6,250 lbs.	14" - 18"
Short-Bed Options			
16536	Q20 head (16530) with R20 roller (16550)	20,000 / 5,000 lbs.	17 1/2" - 21 1/2"
16636	Q20 head with R20 roller (16536) and base rails (16200)	20,000 / 5,000 lbs.	17 1/2" - 21 1/2"
16671	NEW Q20 head with R20 roller (16536) & Chev / GMC puck system roller adapter (16023)	20,000 / 5,000 lbs.	19" - 23"
16677	NEW Q20 head (16530) & Ford puck system roller (16020)	20,000 / 5,000 lbs.	17 1/2" - 21 1/2"
16687	NEW Q20 head with R20 roller (16536) & Ram puck system roller adapter (16022)	20,000 / 5,000 lbs.	19" - 23"
16546	Q24 head (16545) with R24 roller (16570)	24,000 / 6,000 lbs.	17 1/2" - 21 1/2"
16646	Q24 head with R24 roller (16546) and base rails (16200)	24,000 / 6,000 lbs.	17 1/2" - 21 1/2"
16678	NEW Q24 head (16545) & Ford puck system roller (16020)	24,000 / 6,000 lbs.	17 1/2" - 21 1/2"
16688	NEW Q24 head with R24 roller (16546) & Ram puck system roller adapter (16022)	24,000 / 6,000 lbs.	19" - 23"
Individual Components			
16530	Q20 head only	20,000 / 5,000 lbs.	--
16904	Q20 replacement leg kit and hardware	--	--
16545	Q24 head only	24,000 / 6,000 lbs.	--
16913	Q24 replacement leg kit and hardware	--	--
16565	Q25 head only	25,000 / 6,250 lbs.	--
16963	Q25 replacement leg kit and hardware	--	--
16902	Replacement rail pins & clips	--	--

For a guide in selecting the right 5th wheel for your customer's vehicle, see page 296

16k

GTW

E16 5TH WHEEL HITCH

See page 294 for A, Q and E-series hitch comparisons

Product Details

- Up to 16,000 lbs. GTW / 4,000 lbs. vertical load
- Weight ratings are limited to vehicle manufacturer's stated capacities
- Pivots on dual axes for 10° of lateral movement
- Automatically locks for easy, secure coupling
- Operates using a single handle
- Mounts to all industry-standard base rails
- Offers four height adjustment positions to adapt to each unique truck bed
- Compatible with kingpin extension boxes, including common pivoting pin boxes (see page 311 for 5th wheel wedges)
- Protected by a highly durable carbide powder coat finish
- **Five-year limited warranty**



16115



16505

Included in 16515, 16516 and 16616 kits.
Adapts 16115 or 16116 head to CURT rollers



16071



16684



16616

Part#	Description	GTW / Vertical Load	Height Range
Long-Bed Options			
16115	E16 5th wheel hitch	16,000 / 4,000 lbs.	13" - 17"
16116	E16 5th wheel hitch (16115) with base rails (16200)	16,000 / 4,000 lbs.	13" - 17"
16061	E16 head (16515) with Chevrolet / GMC puck system legs (16025)	16,000 / 4,000 lbs.	11 1/2" - 13 1/2"
16031	E16 head (16515) with Ford puck system legs (16017)	16,000 / 4,000 lbs.	11 1/2" - 13 1/2"
16071	E16 head (16515) with Nissan Titan XD puck system legs (16026)	16,000 / 4,000 lbs.	11 1/2" - 13 1/2"
16041	E16 head (16515) with Ram puck system legs (16021)	16,000 / 4,000 lbs.	12 1/2" - 15 1/2"
Short-Bed Options (*16505 adapter included)			
16516*	E16 head (16515) with R16 roller (16560)	16,000 / 4,000 lbs.	14" - 17"
16616*	E16 head (16515) with R16 roller (16560) and base rails (16200)	16,000 / 4,000 lbs.	14" - 17"
16667* NEW	E16 head with R16 roller (16516) & Chev / GMC puck system roller adapter (16023)	16,000 / 4,000 lbs.	16" - 19"
16674 NEW	E16 head (16515) & Ford puck system roller (16020)	16,000 / 4,000 lbs.	14" - 18"
16684* NEW	E16 head with R16 roller (16516) & Ram puck system roller adapter (16022)	16,000 / 4,000 lbs.	16" - 19"
Individual Components			
16515*	E16 head only (16505 adapter included)	16,000 / 4,000 lbs.	--
16903	E16 replacement leg kit and hardware	--	--
16505	E16 head adapter (required for use with a roller)	--	--
16902	Replacement rail pins & clips	--	--

For a guide in selecting the right 5th wheel for your customer's vehicle, see page 296

5TH WHEEL ACCESSORIES

5TH WHEEL HITCH LOCK

- Locks a 5th wheel hitch into the rails, taking the place of a pin & clip
- Extra-long 1/2" diameter pin fits all industry-standard base rails
- Rust-free aluminum housing with a durable black powder coat finish
- Weather-resistant dust cap helps prevent internal corrosion
- Easy-to-operate, 1/8-turn lock activation
- Includes two keys for added convenience

NEW



Locks a 5th wheel to industry-standard rails



23256

Pkg#	Pin Diameter	Finish
23256 NEW	1/2"	Black powder-coated aluminum

KINGPIN LOCK

- Locks on to kingpin to deter theft of 5th wheel trailer
- Universal design fits most 5th wheel trailer kingpins
- Built with an aluminum body for corrosion resistance
- Two keys included for added convenience
- Space-saving, full-color retail packaging



23255 on kingpin



23255

Pkg#	Description	Finish
23255	5th wheel trailer kingpin lock	Chrome-plated

5TH WHEEL WEDGES

A rotating 5th wheel pin box creates an alternative pivot point for the 5th wheel connection, providing the 5th wheel trailer with a wider turn radius. However, because of this secondary pivot point, the original pivot point must be fixed to keep the trailer from wandering. A 5th wheel wedge bolts onto the pin box, locks up the kingpin and keeps it from swiveling.

- Allows CURT A25, A20, A16 or E16 to be used with Sidewinder™ pin boxes (Trademark of Cequent Consumer Products™)
- Prevents unsafe lateral movement between 5th wheel hitch and rotating pin box
- Securely bolts onto the pin box, behind the kingpin
- Protected by a durable carbide powder coat finish

Part#	Fits
16991	E-series 5th wheel hitch
16992	A-series 5th wheel hitches

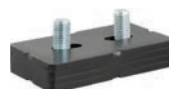

16991



16992

5TH WHEEL LUBE PLATES

- Provides a buffer between 5th wheel hitch head plate and kingpin pin box
- Reduces normal wear and tear when towing
- Eliminates messy grease deposits on hitch head plate
- 12" plate features self-cleaning grooves to maintain good lubrication
- Easily fits on any standard kingpin
- Constructed from tough polyethylene

Bulk#	25-Pack Tray#	Description
16721	16721025	10" 5th wheel lube plate
16722	--	12" 5th wheel lube plate



16721 installation



16722



16721



16721025

5TH WHEEL SAFETY CHAIN LOOPS

- Provides a solid attachment point for 5th wheel safety chains in your truck bed
- Installs easily onto 5th wheel rails with pins & clips
- Constructed with a universal design to fit most 5th wheel rails
- Features wide openings to accept heavy-duty hooks and chains
- Protected by a durable carbide powder coat finish



16000 on base rails



16000

Pkg#	GTW	Description
16000	20,000 lbs.	5th wheel safety chain loops

5TH WHEEL RAIL SOUND-DAMPENING PADS

- Designed to be placed between a 5th wheel hitch and base rails to dampen sound
- Helps eliminate clanking and rattling common in 5th wheel towing
- Compatible with all CURT 5th wheel legs and rollers (except OEM puck system products)
- Constructed from tough neoprene rubber



16900 installed



16900

16901

Bulk#	Pkg#	Description
16900	16901	Four 5th wheel sound-dampening pads

5TH WHEEL ELECTRICAL



CUSTOM WIRING HARNESS EXTENSIONS

- Routes a 7-way RV blade socket into truck bed while retaining use of rear socket
- Simple plug-and-play design eliminates the need for cutting or splicing
- Neoprene well nuts isolate steel bolts from aluminum surfaces (#57007)
- See page 250 for more information



Right-angle plug for easy installation



7-WAY RV BLADE EXTENSION

- Routes existing 7-way RV blade socket into full-size pickup truck bed (7' length)
- Universal size fits any 7-way RV blade socket
- Allows for easy connection of 5th wheel or gooseneck wiring
- See page 251 for more information



56080



REPLACEMENT 7-WAY RV BLADE HARNESSES

- Replaces the trailer-end plug of any 7-way harness
- Wires protected by heavy-duty, weather-resistant cable
- Cold-weather harnesses feature soft thermoplastic elastomer casing to remain flexible in cold temperatures (temperature rating from -40°F up to 221°F)
- See page 251 for more information



56602

56612



BRAKE CONTROLS

- Equipped with quick plugs for fast, easy installation
- Easily calibrated for all towing needs
- See page 238 for our complete brake control line

NEW



51170

NEW



51160

Name	Retail Pkg#	Six-Pack#	Repl. Bracket#	Axles / Brakes	Activation Method	Display	Vertical Mount Angle	Level Adjust	Warranty
Spectrum™	51170 NEW	--	--	1 - 4 / 2 - 8	Tri-axis inertia	Tri-color LED	Any	Auto	Limited Lifetime
Assure™	51160 NEW	--	--	1 - 4 / 2 - 8	Tri-axis inertia	Dot matrix	Any	Auto	Limited Lifetime
TriFlex™	51140	51142	51144	1 - 4 / 2 - 8	Tri-axis inertia	Digital	-20° to +70°	Auto	Limited Lifetime
Relfex™	51130	51132	--	1 - 4 / 2 - 8	Dual-axis inertia	Digital	Any	Auto	Limited Lifetime
Venturer™	51120	51122	51124	1 - 4 / 2 - 8	Time-based	Digital	Any	Auto	Limited Lifetime
Discovery™	51110	--	51114	1 - 3 / 2 - 6	Time-based	LED	Any	Auto	Limited Lifetime



WEIGHT DISTRIBUTION

A PROVEN LINK TO THEIR LIFESTYLE

Towing equipment should never be the limiting factor for your customers. That is why CURT has developed a robust line of weight distribution hitches, offering the perfect fit for any application. Our WD line is spearheaded by our TruTrack™ system with integrated sway control. New for 2018, we have added a new 8K TruTrack™. We also offer our standard trunnion bar and round bar WD hitches in a variety of capacities, and replacement shanks to fit any towing setup or budget.



FEATURED PRODUCTS



TruTrack™

With integrated sway control and weight distribution, TruTrack™ offers smooth, safe towing and is now available in 8K, 10K and 15K options.



TruTrack™ 8" & 10" brackets

Replacement support brackets for the TruTrack™ weight distribution hitch are now available to fit 8" and 10" trailer frames.



MV round bar

This round bar WD hitch features grease zerk fittings built into the head to provide continuous lubrication and a quiet ride.

PRODUCT INDEX



316

Sway Control



318

TruTrack™ WD Systems



320

Trunnion Bar WD Hitches



322

Round Bar WD Hitches



324

Replacement Shanks



325

Brackets & Chains

WEIGHT DISTRIBUTION HITCH FEATURES

CURT weight distribution hitches are designed to distribute the tongue weight of a trailer across all axles of the vehicle-trailer combination, allowing for more control and safer towing. Our TruTrack™ weight distribution system is one of the most advanced weight distribution hitches in the industry. It combines precise weight distribution with integrated sway control to deliver the smoothest, safest ride possible.

- Heavy-duty head and forged steel spring bars
- 2" adjustable shank with 2 1/2" replacement option
- Protected by a durable black powder coat finish
- Kits include a pre-torqued 2 5/16" trailer ball and sway control unit

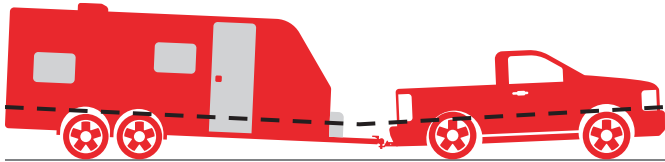

Without weight distribution

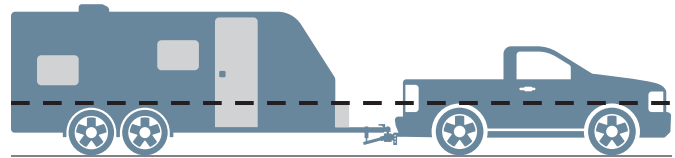

With weight distribution

SWAY CONTROL & REPLACEMENT PARTS

Sway control units reduce lateral movement, commonly caused by the wind, while pulling a trailer. The diagrams below illustrate the effectiveness of using sway control units. Two sway control units should be used for maximum control and stability.



17200

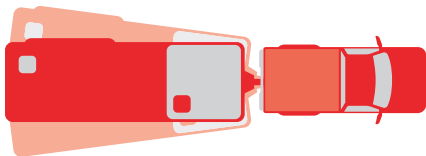

Without sway control



With sway control



45820 with 40093 ball (sold separately)

Bulk#	Pkg#	Description
Sway Control Kit		
--	17200	Kit includes: - Sway control unit - Trailer-mounted attachment ball and bolts (17201) - Hitch-mounted attachment ball (40093) - Weld-on tab (45822) - Mount reinforcement plate - Spring clips
Sway Tab Ball Mount		
45820	--	See page 209 for more information
Sway Control Replacement Parts		
17201	--	Trailer-mounted attachment ball with four self-tapping bolts and two spring clips
40093	--	Sway control attachment ball
45822	--	Weld-on sway tab

WEIGHT DISTRIBUTION HITCH COMPARISON



TruTrack™

- Actively controls trailer sway and levels the vehicle-trailer combination
- GTW capacities ranging from 5,000 up to 15,000 lbs.
- See page 318 for more info



Trunnion bar

- Standard weight distribution with sway control attachment options available
- GTW capacities ranging from 5,000 up to 15,000 lbs.
- See page 320 for more info



Pin-style trunnion bar

- Pin-style spring bars for highly secure attachment and improved durability
- GTW capacities ranging from 5,000 up to 15,000 lbs.
- See page 321 for more info



MV round bar

- Equipped with grease zerk fittings for easy, continuous lubrication
- GTW capacities ranging from 5,000 up to 14,000 lbs.
- See page 322 for more info



Round bar

- Standard weight distribution with sway control attachment options available
- GTW capacities ranging from 5,000 up to 14,000 lbs.
- See page 323 for more info



TRUTRACK™ WEIGHT DISTRIBUTION SYSTEMS

The CURT TruTrack™ weight distribution system is one of the most advanced weight distribution hitches in the industry. It combines precise weight distribution with integrated sway control to deliver the smoothest, safest ride possible. By integrating both features, the TruTrack™ eliminates the need to purchase a separate sway control unit.

Features & Benefits

- Actively controls trailer sway and levels both the vehicle and trailer
- Uses spring & cam system with hardened components, instead of metal friction
- Adjustable brackets provide fixed support unlike spring bar chain models
- Weight capacities available up to 15,000 lbs.
- 12" adjustable shank fits 2" receiver tube openings
- 2 1/2" replacement shank available (see page 324)
- Highly durable carbide powder coat finish
- Informative, full-color retail packaging
- Ten-year limited warranty



True integrated sway control

The spring & cam system and fixed support brackets offer true four-point sway control and weight distribution.



Long-lasting construction

The hardened spring & cam components and cast head are less subject to wear than competitor models.



Quiet operation

Each TruTrack™ hitch is equipped with grease zerk fittings for continuous lubrication and a quiet ride.

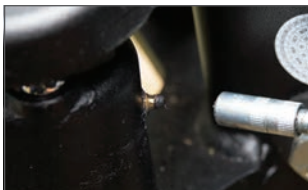

Easy, versatile setup

The TruTrack™ has two neutral bar settings and adjustable castle nuts to accommodate different trailer sizes.



TRUTRACK™ WEIGHT DISTRIBUTION SYSTEMS & REPLACEMENT PARTS



Bulk#	Pkg#	GTW	TW	Bars	Description
TruTrack™ Weight Distribution Systems					
--	17499 NEW	5,000 - 8,000 lbs.	500 - 800 lbs.	35 9/16"	WD system only
--	17500	8,000 - 10,000 lbs.	800 - 1,000 lbs.	35 9/16"	WD system (17500) and pre-torqued 2 5/16" trailer ball (40006)
--	17501	10,000 - 15,000 lbs.	1,000 - 1,500 lbs.	35 9/16"	WD system (17501) and pre-torqued 2 5/16" trailer ball (40030)
TruTrack™ Replacement Parts					
17535 NEW	--	5,000 - 8,000 lbs.	500 - 800 lbs.	35 9/16"	Replacement spring bar for 17501
17536	--	8,000 - 10,000 lbs.	800 - 1,000 lbs.	35 9/16"	Replacement spring bar for 17500
17537	--	10,000 - 15,000 lbs.	1,000 - 1,500 lbs.	35 9/16"	Replacement spring bar for 17501
17506 NEW	--	8,000 lbs.	800 lbs.	--	Replacement head for 17499
17507	--	10,000 lbs.	1,000 lbs.	--	Replacement head for 17500
17509	--	15,000 lbs.	1,500 lbs.	--	Replacement head for 17501
17512	--	--	--	--	Replacement lift handle
17508	--	--	--	--	Repl. support brackets, up to 6" (two brackets)
17515 NEW	--	--	--	--	Replacement support brackets, 8" (two brackets)
17516 NEW	--	--	--	--	Replacement support brackets, 10" (two brackets)
17513 NEW	--	--	--	--	Replacement L-pins & clips
17550	--	--	--	--	Replacement bolt kit for 17500 and 17499
17554	--	--	--	--	Replacement bolt kit for 17501
17100	--	Shanks do not have individual ratings	--	--	Replacement shank (additional shanks found on page 324)



TRUNNION BAR KITS & WD HITCHES

- Up to 15,000 lbs. GTW / 1,500 lbs. TW
- Weight ratings are limited to vehicle manufacturer's stated capacities
- Equipped with trunnion-style, forged steel spring bars
- Heavy-duty, formed head can be adjusted for precise leveling
- Features built-in sway control attachment tabs
- 12" adjustable shank fits 2" receiver tube openings
- 2 1/2" WD replacement shank available (see page 324)
- Snap-up brackets and lift handle allow for easy leveraging of spring bars
- Highly durable carbide powder coat finish
- Informative, full-color retail packaging



Bulk#	Pkg#	GTW	TW	Bars	Description
Trunnion Bar Weight Distribution Kits					
--	17322	8,000 - 10,000 lbs.	800 - 1,000 lbs.	28 3/8"	WD hitch (17332), sway control (17200), pre-torqued 2 5/16" trailer ball (40006) and chains pre-assembled to spring bars
--	17422	10,000 - 15,000 lbs.	1,000 - 1,500 lbs.	28 3/8"	WD hitch (17333), sway control (17200), pre-torqued 2 5/16" trailer ball (40030) and chains pre-assembled to spring bars
Trunnion Bar Weight Distribution Hitches					
--	17300	5,000 - 6,000 lbs.	500 - 600 lbs.	30 5/8"	Weight distribution hitch only
--	17301	6,000 - 8,000 lbs.	600 - 800 lbs.	30 5/8"	Weight distribution hitch only
--	17302	8,000 - 10,000 lbs.	800 - 1,000 lbs.	30 5/8"	Weight distribution hitch only
--	17330	5,000 - 6,000 lbs.	500 - 600 lbs.	28 3/8"	Weight distribution hitch only
--	17331	6,000 - 8,000 lbs.	600 - 800 lbs.	28 3/8"	Weight distribution hitch only
--	17332	8,000 - 10,000 lbs.	800 - 1,000 lbs.	28 3/8"	Weight distribution hitch only
--	17333	10,000 - 15,000 lbs.	1,000 - 1,500 lbs.	28 3/8"	Weight distribution hitch only
Trunnion Bar Replacement Parts					
17309	--	5,000 - 6,000 lbs.	500 - 600 lbs.	30 5/8"	Replacement spring bar with pre-assembled chain
17308	--	6,000 - 8,000 lbs.	600 - 800 lbs.	30 5/8"	Replacement spring bar with pre-assembled chain
17303	--	8,000 - 10,000 lbs.	800 - 1,000 lbs.	30 5/8"	Replacement spring bar with pre-assembled chain
17334	--	5,000 - 6,000 lbs.	500 - 600 lbs.	28 3/8"	Replacement spring bar with pre-assembled chain
17335	--	6,000 - 8,000 lbs.	600 - 800 lbs.	28 3/8"	Replacement spring bar with pre-assembled chain
17336	--	8,000 - 10,000 lbs.	800 - 1,000 lbs.	28 3/8"	Replacement spring bar with pre-assembled chain
17337	--	10,000 - 15,000 lbs.	1,000 - 1,500 lbs.	28 3/8"	Replacement spring bar with pre-assembled chain
17307	--	15,000 lbs.	1,500 lbs.	--	Replacement head
17008	--	--	--	--	Replacement hookup bracket (single)
17112	--	--	--	--	Replacement lift handle
17312	--	--	--	--	Head angle adjustment rod kit
17314	--	--	--	--	Conical washers (set of four)
17350	--	--	--	--	Replacement bolt kit
17100	--	Shanks do not have individual ratings	--	--	Replacement shank (additional shanks found on page 324)

2

INCH

PIN-STYLE TRUNNION BAR WD HITCHES

- Up to 15,000 lbs. GTW / 1,500 lbs. TW
- Weight ratings are limited to vehicle manufacturer's stated capacities
- Pin-style spring bars for highly secure attachment and improved durability
- Tilt adjustment feature simplifies setup and installation
- Equipped with trunnion-style, forged steel spring bars
- Heavy-duty, cast head can be adjusted for precise leveling
- Features built-in sway control attachment tabs
- 12" adjustable shank fits 2" receiver tube openings
- 2 1/2" WD replacement shank available (see page 324)
- Snap-up brackets and lift handle allow for easy leveraging of spring bars
- Highly durable carbide powder coat finish
- Informative, full-color retail packaging



Pin-style spring bars improve strength



Tilt adjustment for easy setup & install



17340

Bulk#	Pkg#	GTW	TW	Bars	Description
Pin-Style Weight Distribution Hitches					
--	17340*	5,000 - 6,000 lbs.	500 - 600 lbs.	30 1/2"	Weight distribution hitch only
--	17341*	6,000 - 8,000 lbs.	600 - 800 lbs.	30 1/2"	Weight distribution hitch only
--	17342*	8,000 - 10,000 lbs.	800 - 1,000 lbs.	30 1/2"	Weight distribution hitch only
--	17347*	10,000 - 15,000 lbs.	1,000 - 1,500 lbs.	30 1/2"	Weight distribution hitch only
Pin-Style Replacement Parts					
17427*	--	8,000 - 10,000 lbs.	800 - 1,000 lbs.	30 1/2"	Replacement spring bar with pre-assembled chain
17407*	--	10,000 lbs.	1,000 lbs.	--	Replacement pin-style head for 17323, 17340, 17341 and 17342
17008	--	--	--	--	Replacement hookup bracket (single)
17112	--	--	--	--	Replacement lift handle
17100	--	Shanks do not have individual ratings	--	--	Replacement shank (additional shanks found on page 324)

* Continued while supplies last



2

INCH

MV ROUND BAR WD HITCHES & KITS

- Up to 14,000 lbs. GTW / 1,400 lbs. TW
- Weight ratings are limited to vehicle manufacturer's stated capacities
- Grease zerk fitting provides easy, continuous lubrication
- Equipped with round, forged steel spring bars for reliable strength
- Heavy-duty, fabricated head can be adjusted for precise leveling
- Features built-in sway control attachment tabs
- 12" adjustable shank fits 2" receiver tube openings
- 2 1/2" WD replacement shank available (see page 324)
- Snap-up brackets and lift handle allow for easy leveraging of spring bars
- Highly durable carbide powder coat finish



Easily accessible grease zerk fittings



17063

Bulk#	Pkg#	GTW	TW	Bars	Description
MV Round Bar Weight Distribution Kits					
--	17062	8,000 - 10,000 lbs.	800 - 1,000 lbs.	31 3/16"	WD hitch (17052), sway control (17200), pre-torqued 2 5/16" trailer ball (40006) and chains pre-assembled to spring bars
--	17063	10,000 - 14,000 lbs.	1,000 - 1,400 lbs.	31 3/16"	WD hitch (17057), sway control (17200), pre-torqued 2 5/16" trailer ball (40030) and chains pre-assembled to spring bars
MV Round Bar Weight Distribution Hitches					
--	17050	5,000 - 6,000 lbs.	500 - 600 lbs.	31 3/16"	Round bar weight distribution hitch
--	17051	6,000 - 8,000 lbs.	600 - 800 lbs.	31 3/16"	Round bar weight distribution hitch
--	17052	8,000 - 10,000 lbs.	800 - 1,000 lbs.	31 3/16"	Round bar weight distribution hitch
--	17057	10,000 - 14,000 lbs.	1,000 - 1,400 lbs.	31 3/16"	Round bar weight distribution hitch
MV Round Bar Replacement Parts					
17071	--	5,000 - 6,000 lbs.	500 - 600 lbs.	31 3/16"	Replacement spring bar with pre-assembled chain
17072	--	6,000 - 8,000 lbs.	600 - 800 lbs.	31 3/16"	Replacement spring bar with pre-assembled chain
17073	--	8,000 - 10,000 lbs.	800 - 1,000 lbs.	31 3/16"	Replacement spring bar with pre-assembled chain
17074	--	10,000 - 14,000 lbs.	1,000 - 1,400 lbs.	31 3/16"	Replacement spring bar with pre-assembled chain
17075	--	14,000 lbs.	1,400 lbs.	--	Replacement head
17008	--	--	--	--	Replacement hookup bracket (single)
17112	--	--	--	--	Replacement lift handle
17076	--	--	--	--	Replacement bolt kit
17100	--	Shanks do not have individual ratings	--	--	Replacement shank (additional shanks found on page 324)

2

INCH

ROUND BAR WD HITCHES & KITS

- Up to 14,000 lbs. GTW / 1,400 lbs. TW
- Weight ratings are limited to vehicle manufacturer's stated capacities
- Equipped with round, forged steel spring bars for reliable strength
- Heavy-duty, formed head can be adjusted for precise leveling
- Features built-in sway control attachment tabs
- 12" adjustable shank fits 2" receiver tube openings
- 2 1/2" WD replacement shank available (see page 324)
- Snap-up brackets and lift handle allow for easy leveraging of spring bars
- Highly durable carbide powder coat finish
- Informative, full-color retail packaging



17222

Bulk#	Pkg#	GTW	TW	Bars	Description
Round Bar Weight Distribution Kits					
--	17022	8,000 - 10,000 lbs.	800 - 1,000 lbs.	31 5/8"	WD hitch (17002), sway control (17200), pre-torqued 2 5/16" trailer ball (40006) and chains pre-assembled to spring bars
--	17222	10,000 - 14,000 lbs.	1,000 - 1,400 lbs.	31 5/8"	WD hitch (17007), sway control (17200), pre-torqued 2 5/16" trailer ball (40030) and chains pre-assembled to spring bars
Round Bar Weight Distribution Hitches					
--	17000	5,000 - 6,000 lbs.	500 - 600 lbs.	31 5/8"	Round bar weight distribution hitch
--	17001	6,000 - 8,000 lbs.	600 - 800 lbs.	31 5/8"	Round bar weight distribution hitch
--	17002	8,000 - 10,000 lbs.	800 - 1,000 lbs.	31 5/8"	Round bar weight distribution hitch
--	17007	10,000 - 14,000 lbs.	1,000 - 1,400 lbs.	31 5/8"	Round bar weight distribution hitch
Round Bar Replacement Parts					
17101	--	5,000 - 6,000 lbs.	500 - 600 lbs.	31 5/8"	Replacement spring bar with pre-assembled chain
17113	--	6,000 - 8,000 lbs.	600 - 800 lbs.	31 5/8"	Replacement spring bar with pre-assembled chain
17115	--	8,000 - 10,000 lbs.	800 - 1,000 lbs.	31 5/8"	Replacement spring bar with pre-assembled chain
17117	--	10,000 - 14,000 lbs.	1,000 - 1,400 lbs.	31 5/8"	Replacement spring bar with pre-assembled chain
17107	--	14,000 lbs.	1,400 lbs.	--	Replacement head
17008	--	--	--	--	Replacement hookup bracket (single)
17112	--	--	--	--	Replacement lift handle
17109	--	--	--	--	Retainer package (two clips, two pins, two screws)
17114	--	--	--	--	Head adjustment spacer kit
17312	--	--	--	--	Head angle adjustment rod kit
17314	--	--	--	--	Conical washers (set of four)
17150	--	--	--	--	Replacement bolt kit
17100	--	Shanks do not have individual ratings	--	--	Replacement shank (additional shanks found on page 324)

2 INCH & **2 1/2** INCH

REPLACEMENT WD SHANKS

- Provides an adjustable mount for most weight distribution hitches
- Features multiple holes for adjustable head height
- Can be flipped to provide necessary drop or rise
- 2 1/2" shank ideal for class 5 Commercial Duty hitches (#17128) (page 15)
- 3/4" diameter holes are spaced 1 1/4" from center to center
- Constructed from solid steel for reliable strength
- Protected by a durable powder coat finish
- Limited to spring bar capacity



Measuring a WD shank

See table for corresponding measurements

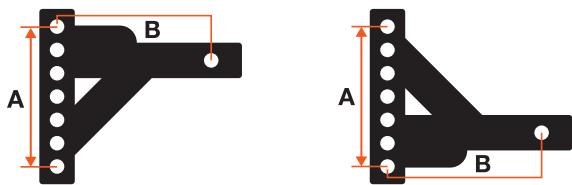

Measuring a WD shank with WD hitch head

See table for corresponding measurements

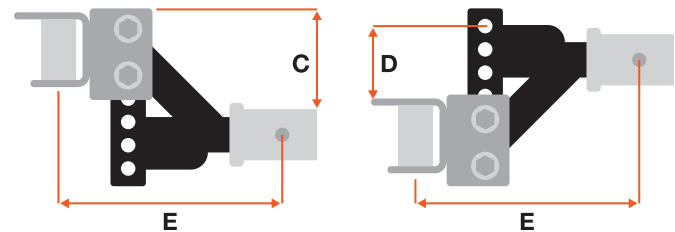

Part#	Measuring a WD Shank		Measuring a WD Shank with a WD Hitch Head		
	Height (A)	Length (B)	Rise (C)	Drop (D)	Length (E)
For 2" x 2" Receiver Tube Openings					
17100	7 1/2"	8"	6"	2"	12"
17102	7 1/2"	12"	6"	2"	14"
17103	7 1/2"	14"	6"	2"	16"
17120	8 3/4"	10"	8 7/8"	5 5/8"	12"
17121	10"	12"	10 1/4"	6"	14"
17122	10"	14"	10 1/4"	6"	16"
17123	11 1/4"	7"	10 1/2"	7"	9"
17124	6 1/4"	9"	N/A	8 3/4"	11"
17125	6 1/4"	8"	N/A	14 1/2"	10"
For 2 1/2" x 2 1/2" Receiver Tube Openings					
17128	7 1/2"	8"	6"	2"	12"

HOOKUP BRACKETS & ACCESSORIES

- Replaces original brackets
- Hardware included



Bulk#	Pkg#	Description	Finish
--	17003	Clamp-on chain hangers	Carbide
--	17005	Bolt-on chain hangers	Carbide
17008	--	Replacement hookup bracket (single)	Carbide
17208*	--	Replacement hookup brackets (pair)	Carbide
17111	--	Chain kit (includes four 3/8" - 16 lock nuts, four 3/8" flat washers, two chains and two U-bolts)	Zinc-plated
17112	--	Replacement lift handle	Carbide
17109	--	Retainer package (two clips, two pins, two screws)	Carbide

*For use on trailers with LP tanks or other obstructions





TRAILER PARTS & ACCESSORIES

WHERE SAFETY MEETS FREEDOM

From tongue to back, CURT has everything your customers need to keep their trailer towing in optimal condition. We offer jacks, safety chains and couplers in a variety of styles and capacities to accommodate virtually any type of trailer – everything from utility haulers and popup campers to horse trailers and 5th wheel RVs. We also offer a number of accessories to fully equip your customers for the road ahead, including hand winches, wheel bearings, snap hooks and wheel chocks.

FEATURED PRODUCTS



Channel-mount couplers

Mounted on a CURT channel, channel-mount couplers make it easy to adjust the tongue height of a trailer and level the load.



Marine jacks

Ideal for boat trailers and other watercraft haulers, marine jacks are water-resistant and have a wheel for convenient mobility.



Safety cables

Safety cables feature the strength of our safety chains with the added convenience of a coiled design to avoid dragging on the ground.

PRODUCT INDEX



328
Couplers
& Repair Kits



330
Jacks &
Accessories



333
Safety Chains
& Cables



336
Hooks
& Latches



339
Hand Winches
& Straps



340
Wheel Bearing
Components



341
Cargo
Straps



342
Rings & Tie-
Down Anchors

STRAIGHT-TONGUE & A-FRAME COUPLERS

- Sleeve-lock latch system for optimum security
- Spring and nut posi-lock mechanism allows for easy adjustment
- Features holes to accept a safety pin or coupler lock
- Constructed from punched, die-cut steel
- Protected by a durable zinc-plated or gloss black powder coat finish
- Tested for safety in accordance with SAE-J684
- Three-year limited warranty



Part#	Class	GTW / TW	Ball Diameter	Latch Style	Channel Width	Finish
Straight-Tongue Couplers						
25105	1	2,000 / 200 lbs.	1 7/8"	Posi-lock	2 1/2"	Zinc-plated
25128	1	2,000 / 200 lbs.	1 7/8"	Posi-lock	2"	Zinc-plated
25131	1	2,000 / 200 lbs.	1 7/8"	Posi-lock	3"	Zinc-plated
25153	2	3,500 / 500 lbs.	2"	Posi-lock	2"	Zinc-plated
25135	2	3,500 / 500 lbs.	2"	Posi-lock	2 1/2"	Zinc-plated
25138	2	3,500 / 500 lbs.	2"	Posi-lock	3"	Zinc-plated
25100	3	5,000 / 700 lbs.	2"	Posi-lock	3"	Zinc-plated
A-Frame Couplers						
25101	3	5,000 / 700 lbs.	2"	Posi-lock	--	Zinc-plated
25210	3	5,000 / 700 lbs.	2"	Posi-lock	--	Gloss black
25217*	4	7,000 / 1,050 lbs.	2"	Sleeve-lock	--	Gloss black
25200	4	10,000 / 1,500 lbs.	2 5/16"	Easy-lock	--	Gloss black
25227*	4	12,500 / 1,875 lbs.	2 5/16"	Sleeve-lock	--	Gloss black
Replacement Part for #25101 and #25210 A-Frame Couplers						
25294	3	5,000 / 700 lbs.	2"	Posi-lock	--	Zinc-plated
Replacement Parts for Straight-Tongue Couplers						
25094	1	2,000 / 200 lbs.	1 7/8"	Posi-lock	--	Zinc-plated
25194	2	3,500 / 500 lbs.	2"	Posi-lock	--	Zinc-plated



*Solid neck for increased strength and greater corrosion resistance

CHANNEL-MOUNT COUPLERS

- Compatible with CURT channels #48610 and #48650
- Secured by a dual-bolt mounting system
- Channel-mount allows for easy height adjustment
- Safety pin hole can also accept a coupler lock
- Constructed from heavy-duty cast steel
- Protected by a durable black powder coat finish
- **Three-year limited warranty**



Part#	GTW / TW	Ball Diameter	Description
25319*	7,000 / 1,050 lbs.	2"	Sleeve-lock coupler
25329*	12,500 / 1,875 lbs.	2 5/16"	Sleeve-lock coupler
25330	14,000 / 2,100 lbs.	2 5/16"	Easy-lock coupler
25328	15,000 / 2,250 lbs.	2 5/16"	Easy-lock coupler
25388	--	--	Bolt kit includes: -Two 5/8" x 4 3/4" hex bolts (grade 8) -Two 5/8" nylock hex nuts (grade 5) -Four 5/8" flat washers (grade 5)

*Solid neck for increased strength and greater corrosion resistance

SAFETY PINS

- Quickly secures coupler latches, pintle hooks, jack legs or caster wheels
- Square retainer wire clip provides added clearance
- Protected by a durable zinc-plated finish



Bulk#	Pkg#	Pin Diameter	Pin Length	Chain Length
25080	25081	1/4"	2 3/4"	--
25012	25013	1/4"	2 3/4"	12" chain
25010	25011	5/16"	3"	--
25034	25035	5/16"	3"	12" chain
28278	28279	3/8"	2 3/4"	--
28000	28001	3/8"	3"	12" chain



#25034 securing a coupler latch



#28278 securing a jack foot

MARINE JACKS

- Caster wheel for trailer mobility and coupling
- Side-wind handle raises or lowers trailer coupler
- Swivel bracket allows jack to fully swing up and out of the way for travel
- Heavy-duty pull-pin locks jack securely in place
- Bolt-on hardware included for secure mounting
- Protected by a durable zinc-plated finish
- See page 332 for repair parts and accessories



28100



28101

Bulk#	Pkg#	Capacity	Wind	Travel	Bracket Height	Wheel Size	Finish
28100	28101	1,000 lbs.	Side	10"	12 11/16"	6"	Zinc-plated
28112	28113	1,200 lbs.	Side	10"	12 11/16"	6"	Zinc-plated
28115	28116	1,500 lbs.	Side	10"	12 11/16"	8"	Zinc-plated
28155	28156	1,500 lbs.	Side	10"	12 1/2"	Dual 6"	Zinc-plated

A-FRAME JACKS

- Designed to be mounted on an A-frame trailer tongue
- Can bolted or welded on (hardware not included)
- See page 332 for repair parts and accessories



28204
side-wind



28255
top-wind



28203
top-wind

Bulk#	Pkg#	Capacity	Wind	Travel	Bracket Height	Handle Type	Tube Size
28200	--	2,000 lbs.	Top	14"	8"	Straight	2"
28202	28203	2,000 lbs.	Top	15"	9"	Straight	2"
28204	--	2,000 lbs.	Side	14 1/2"	9"	Straight	2"
28250	--	5,000 lbs.	Top	14"	10 1/2"	Straight	2"
28255	--	5,000 lbs.	Top	15"	10 1/2"	Claw	2"

SWIVEL JACKS

- Swivel bracket allows jack to fully swing up and out of the way during travel
- Pull-pin keeps jack securely locked in place
- See page 332 for repair parts and accessories



28302
bracket mount



28354
pipe-mount



28351
pipe-mount

Bulk#	Pkg#	Capacity	Wind	Travel	Hole Size	Handle Type	Style
28320*	--	2,000 lbs.	Top	10"	9/16"	Claw	Pipe-mount
28350*	28351*	5,000 lbs.	Top	10"	9/16"	Claw	Pipe-mount
28356*	--	5,000 lbs.	Top	15"	5/8"	Claw	Pipe-mount
28322*	28323*	2,000 lbs.	Top	15"	9/16"	Claw	Pipe-mount
28321	--	2,000 lbs.	Side	10"	9/16"	Straight	Pipe-mount
28354	--	5,000 lbs.	Side	10"	5/8"	Straight	Pipe-mount
28358	--	5,000 lbs.	Side	15"	5/8"	Straight	Pipe-mount
28324	--	2,000 lbs.	Side	15"	9/16"	Straight	Pipe-mount
28300*	28301*	2,000 lbs.	Top	10"	--	Claw	Bracket-mount
28302	--	2,000 lbs.	Side	10"	--	Straight	Bracket-mount
28304*	28305*	2,000 lbs.	Top	15"	--	Claw	Bracket-mount
28306	--	2,000 lbs.	Side	15"	--	Straight	Bracket-mount

*Use replacement handle, bulk# 28937

DIRECT-WELD SQUARE JACKS

- Designed to weld directly to the trailer frame
- Drop leg with spring return for fast retraction (#28512)
- Pull-pin keeps jack leg securely locked in place
- See page 332 for repair parts and accessories



28512



28570



28575



28359

Part#	Support Capacity	Lift Capacity	Wind	Travel	Handle Type	Includes Jack Foot
28512	12,000 lbs.	10,000 lbs.	Side	12 1/2"	Straight	Yes
28570	8,000 lbs.	7,000 lbs.	Top	15"	Claw	Yes
28575	8,000 lbs.	7,000 lbs.	Side	15"	Straight	Yes
28359	5,000 lbs.	3,000 lbs.	Side	15"	Straight	No

JACK ACCESSORIES

- Caster assemblies (#28276 and #28277) are not designed as repair parts for marine jacks; use jack repair part number #28912



28270 28271



28273 28272



28275 28274



28277 28276



28278 28279

Bulk#	Pkg#	Capacity	Fits Tube	Height	Wheel Size	Diameter	Description
28270	28271	2,000 lbs.	2"	--	--	--	Jack foot, bolt-on
28272	28273	2,000 lbs.	2"	1 11/16"	--	--	Jack foot
28274	28275	2,000 lbs.	2"	8 1/2"	--	--	Jack foot
28276	28277	1,200 lbs.	2"	--	6" x 2"	--	Caster assembly with poly wheel
28278	28279	--	--	--	--	3/8"	Safety pin

JACK REPAIR PARTS



28913



28964



28951



28938



28940



28912

Part#	Description
Marine Jacks	
28910	Bolt-through jack mounting bracket
28911	Bolt-through jack mounting bars (two) and bolts (four)
28912	Replacement caster wheel with bolt and bushing
28913	Replacement handle for marine jacks (excluding continue-while-supplies-last jacks)
28914	Gear kit with shear pins
A-Frame Jacks	
28921	Handle for 28200, 28202, 28203, 28250
Swivel Jacks	
28922	Bearing for 2,000 lbs. and 5,000 lbs. top-wind jacks
28923	Handle for 2,000 lbs. and 5,000 lbs. side-wind jacks
28924	Gear kit with shear pins for 2,000 lbs. and 5,000 lbs. side-wind jacks
28930	Female pipe weld-on for 2,000 lbs. and 5,000 lbs. pipe-mounted swivel jacks
28931	Male pipe weld-on for 2,000 lbs. and 5,000 lbs. pipe-mounted swivel jacks, 9/16" pin hole
28932	Male pipe weld-on for 2,000 lbs. and 5,000 lbs. pipe-mounted swivel jacks, 5/8" pin hole
28934	9/16" pin with 3 1/2" long chain
28935	5/8" pin with 3 1/2" long chain
28938	Mounting bracket for bracket-mounted swivel jacks

Part#	Description
Direct-Weld Square Jacks	
28950	Gear kit with shear pins for 28512
28951	Handle for 28512
28952	Cap for 28512
28953	Handle clip for 28512
28954	Bearing for 28512
28955	Pull-pin assembly designed for 28512 (3/4" pull-pin, spring, washer and cotter pin)
28956	Threaded lift nut with grease retaining structure for 28512
28957	Inner pipes with drop leg, foot and pull-pin for 28512
28958	Gear kit with shear pins for 28575
28959	Side-wind handle with pins and bushings for 28575
28960	Side-wind handle with pins, bushings and gears for 28575
28961	Cap and screws for 28575
28962	Drop leg with foot for 28570 and 28575
28963	Drop leg foot pin for 28570 and 28575
28964	Handle kit for 28570
28965	Bearing for 28570
Miscellaneous Repair Parts	
28925	Plastic cap for 2,000 lbs. side-wind jacks
28926	Black handle knob and cap nut
28927	Black handle knob and cap nut for top-wind jacks
28937	Solid handle for top-wind jacks
28939	2" snap ring for 28100, 28304, 28302, 28300
28940	1/2" pull-pin for bracket-mounted swivel and marine jacks

BULK CHAIN

- High-test chain for wear and abrasion resistance
- Transport chain for binding applications
- Alloy chain for high work load limits
- All bulk chain is sold by the foot

Bulk#	Break Strength	Link Diameter	Grade	Finish
Proof Coil				
82116	3,200 lbs.	3/16"	30	Zinc-plated
82165	3,700 lbs.	5/0	30	Zinc-plated
82105	5,200 lbs.	1/4"	30	Zinc-plated
82170	7,600 lbs.	8/0	30	Zinc-plated
82110	7,600 lbs.	5/16"	30	Zinc-plated
82115	10,600 lbs.	3/8"	30	Zinc-plated
High-test				
82120	7,800 lbs.	1/4"	43	Zinc-plated
82125	11,700 lbs.	5/16"	43	Zinc-plated
82130	16,200 lbs.	3/8"	43	Zinc-plated
Transport				
82135	12,600 lbs.	1/4"	70	Yellow zinc-plated
82140	18,800 lbs.	5/16"	70	Yellow zinc-plated
82145	26,400 lbs.	3/8"	70	Yellow zinc-plated
82155	45,200 lbs.	1/2"	70	Yellow zinc-plated
Alloy				
82158	48,000 lbs.	1/2"	80	Raw
82160	72,400 lbs.	5/8"	80	Yellow zinc-plated



CUSTOM SAFETY CHAIN

Safety chains are required by law and should be crossed under the tongue of the trailer so that the tongue will not drop to the road if it becomes separated from the hitch. Always leave enough slack so the vehicle can safely turn. Never allow the safety chains to drag on the ground and never attach the chains to the bumper.

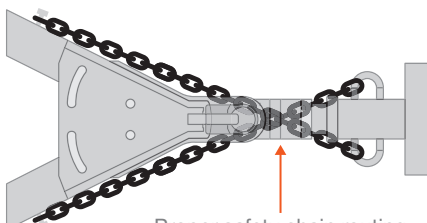

Proper safety chain routing crosses under the coupler

How to order custom safety chain:

- Step 1 - Determine the gross weight of the trailer
Example: 7,000 lbs. GTW
- Step 2 - Select chain required
Example: #82120 zinc-plated (7,800 lbs.)
Note: By law each individual chain must meet or exceed the GTW
- Step 3 - Determine the required length of chain
Note: The chains must be long enough to cross one over the other under the coupling point (see illustration to the left)
- Step 4 - Select hook(s) according to capacity and design
Example: #81900 clevis hook (7,800 lbs.)
- Step 5 - Contact your CURT sales rep for a quote



Federal law requires safety chains to be secured while towing.
Each individual chain or cable must meet or exceed the trailer weight.

SAFETY CHAIN WITH S-HOOKS

- Helps resist complete vehicle-trailer separation during a disconnect
- Protected by a durable zinc-plated finish



S-hook



Safety chains in use



Bulk#	Pkg#	Break Strength	Number of Chains	Total Length	Link Diameter	Hooks Per Chain	Hook Size	Chain Length	Grade	Finish
80020	--	2,000 lbs.	1	27"	3/16"	1 (81260)	3/8"	23"	30	Zinc-plated
80010	80011	2,000 lbs.	1	48"	3/16"	2 (81260)	3/8"	40"	30	Zinc-plated
80040	--	5,000 lbs.	1	27"	1/4"	1 (81270)	7/16"	23"	30	Zinc-plated
80030	80031	5,000 lbs.	1	48"	1/4"	2 (81270)	7/16"	40"	30	Zinc-plated
80300	--	7,000 lbs.	1	27"	8/0	1 (81620)	17/32"	23"	30	Zinc-plated
80301	--	7,000 lbs.	1	48"	8/0	2 (81620)	17/32"	40"	30	Zinc-plated

SAFETY CHAIN WITH SNAP HOOKS

- Helps resist complete vehicle-trailer separation during a disconnect
- Spring-loaded safety latch helps ensure secure attachment
- Protected by a durable zinc-plated finish
- Vinyl coating protects chains from rust and allows for easier handling (#19749)



19749



80312



80313



Snap hook

Bulk#	Pkg#	Break Strength	Number of Chains	Total Length	Link Diameter	Hooks Per Chain	Hook Size	Chain Length	Grade	Finish
80312	--	2,000 lbs.	One	27"	3/16"	1 (81266)	3/8"	24"	30	Zinc-plated
80313	--	5,000 lbs.	One	27"	1/4"	1 (81277)	7/16"	24"	30	Zinc-plated
--	19749	5,000 lbs.	Two	65"	1/4"	2 (81260)	7/16"	60"	30	Zinc-plated with rubber coating

SAFETY CABLES WITH SAFETY LATCH HOOKS

- Helps resist complete vehicle-trailer separation during a disconnect
- Coiled design keeps cables from dragging on the ground
- Nylon coating protects cables from rust and allows for easier handling
- Assembled with two safety latch hooks for secure attachment



Safety latch S-hook



Safety cables in use



80136



80151



80176

Pkg#	Break Strength	Number of Cables	Total Length	Cable Diameter	Hooks Per Cable	Hook Size	Cable Length	Cable Finish	Hook Finish
80136	3,500 lbs.	2	43 7/8"	1/4"	2 (81810)	3/8"	40 1/2"	Nylon-coated	Zinc-plated
80151	5,000 lbs.	2	44 1/2"	5/16"	2 (81820)	7/16"	40 1/2"	Nylon-coated	Zinc-plated
80176	7,500 lbs.	2	44"	3/8"	2 (81830)	17/32"	39 3/4"	Nylon-coated	Zinc-plated

SAFETY CHAIN WITH SAFETY LATCH CLEVIS HOOKS

- Helps resist complete vehicle-trailer separation during a disconnect
- Exclusive clevis design and spring-loaded safety latch help ensure secure attachment
- Hook pin and cotter pin provide an easy, secure attachment to safety chain
- Hooks constructed from high-strength, heat-treated, forged steel
- Protected by a durable zinc-plated finish



80315 with 45500



Zinc-plated



Yellow zinc-plated



Safety latch clevis hooks

Part#	Break Strength	Number of Chins	Total Length	Link Diameter	Hooks Per Chain	Hook Size	Chain Length	Grade	Chain Finish	Hook Finish
80302	7,800 lbs.	1	35"	1/4"	1 (81900)	1/4"	32"	43	Zinc-plated	Yellow zinc-plated
80314	11,700 lbs.	1	35"	5/16"	1 (81550)	5/16"	32"	43	Zinc-plated	Yellow zinc-plated
80303	12,600 lbs.	1	35"	1/4"	1 (81940)	1/4"	32"	70	Yellow zinc-plated	Yellow zinc-plated
80315	16,200 lbs.	1	35"	3/8"	1 (81560)	3/8"	31"	43	Zinc-plated	Yellow zinc-plated
80304	18,800 lbs.	1	35"	5/16"	1 (81950)	5/16"	32"	70	Yellow zinc-plated	Yellow zinc-plated
80316	24,000 lbs.	1	35"	3/8"	1 (81960)	3/8"	31"	70	Yellow zinc-plated	Yellow zinc-plated



Federal law requires safety chains to be secured while towing.
Each individual chain or cable must meet or exceed the trailer weight.

TRANSPORT BINDER SAFETY CHAIN

- Designed for tying down and binding heavy-duty cargo
- Grade 70 rating for superior tensile strength and abrasion resistance
- Assembled with two clevis grab hooks for secure attachment
- Protected by a durable yellow zinc-plated finish
- Do not exceed work load limit



80306



80308

Part#	Work Load	Break Strength	Total Length	Link Diameter	Hooks Per Chain	Hook Size	Chain Length	Grade	Finish
80305	4,700 lbs.	18,800 lbs.	14'	5/16"	2 (81503)	5/16"	162"	70	Yellow zinc
80306	4,700 lbs.	18,800 lbs.	16'	5/16"	2 (81503)	5/16"	186"	70	Yellow zinc
80307	4,700 lbs.	18,800 lbs.	20'	5/16"	2 (81503)	5/16"	234"	70	Yellow zinc
80308	4,700 lbs.	18,800 lbs.	25'	5/16"	2 (81503)	5/16"	294"	70	Yellow zinc
80309	6,600 lbs.	26,400 lbs.	14'	3/8"	2 (81438)	3/8"	162"	70	Yellow zinc
80310	6,600 lbs.	26,400 lbs.	16'	3/8"	2 (81438)	3/8"	186"	70	Yellow zinc
80311	6,600 lbs.	26,400 lbs.	20'	3/8"	2 (81438)	3/8"	234"	70	Yellow zinc

CLEVIS GRAB HOOKS

- Designed for use on transport binder safety chain to tie down heavy cargo
- Can also be used to connect safety chains from trailer to tow vehicle
- Meets requirements for high-test chain
- Hook pin and cotter pin provide an easy, secure attachment to safety chain
- Constructed from high-strength, heat-treated steel
- Protected by a durable zinc-plated finish



81330



81502



81340



81503



81350



81438

Part#	GTW	Hook Size	Grade	Finish
81330	2,600 lbs.	1/4"	43	Zinc-plated
81502	3,150 lbs.	1/4"	70	Yellow zinc-plated
81340	3,900 lbs.	5/16"	43	Zinc-plated
81503	4,700 lbs.	5/16"	70	Yellow zinc-plated
81350	5,400 lbs.	3/8"	43	Zinc-plated
81438	6,600 lbs.	3/8"	70	Yellow zinc-plated

SAFETY LATCH CLEVIS HOOKS

- Quickly and easily connects safety chains from trailer to tow vehicle
- Exclusive design and spring-loaded safety latch help ensure secure attachment
- Meets requirements for high-test chain
- Hook pin and cotter pin provide an easy, secure attachment to safety chain
- Built from high-strength, heat-treated, forged steel
- Protected by a durable yellow zinc-plated finish

Part#	GTW	Hook Size	Grade	Hook Size
Clevis Hooks				
81900	7,800 lbs.	1/2"	43	1/4"
81940	12,600 lbs.	1/2"	70	1/4"
81550	14,000 lbs.	3/4"	43	5/16"
81950	18,000 lbs.	3/4"	70	5/16"
81560	18,000 lbs.	1"	43	3/8"
81960	24,000 lbs.	1"	70	3/8"
81970	40,000 lbs.	1 1/3"	80	7/16"
81910	35,000 lbs.	1 1/4"	43	1/2"
81980	48,000 lbs.	1 1/4"	80	1/2"
81920	65,000 lbs.	1 1/4"	80	5/8"
Replacement Latch				
81999	Fits 81950 and 81960			



81999



81900



81940



81550



81950



81560



81960



81970



81910



81980



81920

CERTIFIED & SAFETY LATCH S-HOOKS

- Quickly and easily connects safety chains from trailer to tow vehicle
- Tested for safety in accordance with SAE-J684
- Wire safety latch helps ensure secure attachment
- Constructed from high-strength, heat-treated steel
- Protected by a durable zinc-plated finish

Part#	GTW	Hook Size	Safety Latch
81260	2,000 lbs.	3/8"	No
81810	2,000 lbs.	3/8"	Yes
81640	3,500 lbs.	13/32"	No
81840	3,500 lbs.	13/32"	Yes
81270	5,000 lbs.	7/16"	No
81820	5,000 lbs.	7/16"	Yes
81620	7,600 lbs.	17/32"	No
81830	7,600 lbs.	17/32"	Yes



81810



81260



81840



81640



81820



81270



81830



81620



Federal law requires safety chains to be secured while towing.
Each individual chain or cable must meet or exceed the trailer weight.

SNAP HOOKS

- Quickly and easily connects safety chains from trailer to tow vehicle
- Spring-loaded safety latch helps ensure secure attachment
- Patent# 5,664,304

Bulk#	Pkg#	GTW	Diameter
81266	81261	2,000 lbs.	3/8"
81277	81271	5,000 lbs.	7/16"
81288	81281	5,000 lbs.	9/16"
81360	--	3,500 lbs.	5/8" eye



QUICK LINKS

- Provides a quick connection for chains, cables, ropes or straps
- Threaded link ensures secure attachment with the option to disconnect later
- Requires no tools for installation
- Do not exceed work load limit

Bulk#	Pkg#	Two-Pack#	Work Load	Diameter	Finish
82610	82611	--	880 lbs.	1/4"	Zinc
82900	82901	82903	1,760 lbs.	5/16"	Zinc
82930	82933	--	2,200 lbs.	3/8"	Zinc
82931	--	--	2,640 lbs.	7/16"	Zinc
82932	--	--	3,300 lbs.	1/2"	Zinc



JOINING LINKS

- Constructed from 1038 steel
- Do not use for lifting

Part#	Finish	Size
82940	Raw	9/0
82942	Raw	7/16"
82943	Zinc-plated	9/0
82944	Zinc-plated	7/16"



HAND WINCHES

- Crank-style winch for boat trailers or hoisting applications
- Constructed from high-strength, cold-forged steel
- Equipped with a locking lever for increased safety
- Strong pinions eliminate gear-to-shaft bonding failures
- Broached pinion shaft securely engages the pinion gear
- Handle with plastic grip cover for easy, comfortable operation
- Base features slotted screw holes for flexible mounting
- Straps made from 2" wide, no-stretch nylon web
- Zinc-plated snap hook for easy, secure hookup



23423 pinion gear



23424 pinion gear



23427 crank handle



23438 locking lever



Pkg#	Capacity	Gear Ratio	Hub Diameter	Handle Length	Strap
29423	900 lbs.	3.25:1	3/4"	6 1/2"	No
29433	900 lbs.	3.25:1	3/4"	6 1/2"	Yes, 15' (29450)
29424	1,200 lbs.	4.2:1	3/4"	7 1/2"	No
29425	1,400 lbs.	4.2:1	3/4"	7 1/2"	No
29435	1,400 lbs.	4.2:1	3/4"	7 1/2"	Yes, 20' (29451)
29427	1,700 lbs.	5.1:1	1"	8"	No
29428	1,900 lbs.	5.1:1	1"	8"	No
29438	1,900 lbs.	5.1:1	1"	8"	Yes, 20' (29451)
29429	2,100 lbs.	5.1:1	1"	9 3/4"	No

WINCH STRAPS

- Made from 2" wide, no-stretch nylon web
- Zinc-plated snap hook for easy, secure hookup



Bulk#	Pkg#	Work Load	Break Strength	Strap Width	Strap Length
29007	--	1,333 lbs.	4,000 lbs.	2"	20'
--	29450	1,100 lbs.	3,300 lbs.	2"	15'
--	29451	1,100 lbs.	3,300 lbs.	2"	20'

WHEEL BEARING KITS

- Automatically maintains the correct internal pressure to avoid seal damage
- Includes two bearing cones, two bearing cups, a grease seal and cotter pin

Pkg#	Spindle O.D.	Kit Includes
23209	3/4"	(2) LM11910, (2) LM11949, seal, cotter pin
23210	1"	(2) L44643, (2) L44610, seal, cotter pin
23211	1 1/16"	(2) L44649, (2) L44610, seal, cotter pin



BEARING PROTECTORS & REPLACEMENT DUST COVERS

- Protects wheel bearings from dirt, water and road grime
- Maintains pressure and keeps bearing greased
- Features a small reservoir to keep bearings well-lubricated
- Covers prevent dust and debris from entering the bearing protector
- Includes two protectors and two dust covers



Bearing Protector#	Replacement Cover Two-Pack#	Hub Bore Size
22178	23178	1.78" diameter
22198	23198	1.98" diameter
22232	23232	2.32" diameter
22244	23244	2.44" diameter

WHEEL CHOCK SET

- Perfect for chocking wheels on a parked trailer or adding safety during vehicle maintenance
- Raised tread offers a better grip on the wheel
- Saw-tooth edges on the base provide solid traction on the ground
- Always to be used with vehicle brake
- Not for commercial use



Part#	Description
22800	For use with wheels up to 17" wide

CARGO STRAPS

- Perfect for securing cargo in trailers, truck beds and more
- Offers a superior tie-down method compared to bungee cords and rope
- Cambuckle mechanism allows for direct tension on lighter loads
- Ratchet mechanism allows for greater tension on heavy loads
- Straps constructed from high-strength, woven nylon
- Cinching components protected by a durable yellow zinc-plated finish



Secures cargo better than bungee cords or rope



Pkg#	Work Load	Break Strength	Strap Color	Strap Length	Strap Width	Hook Style	Hook Finish	Strap Quantity	Mechanism
83015	300 lbs.	900 lbs.	Dark green	15'	1"	S-hook	Rubber-coated	2	Cambuckle
83016	300 lbs.	900 lbs.	Dark green	16'	1"	S-hook	Rubber-coated	4	Cambuckle
83001	500 lbs.	1,500 lbs.	Red	10'	1"	S-hook	Rubber-coated	2	Ratchet
83002	500 lbs.	1,500 lbs.	Red	16'	1"	S-hook	Rubber-coated	4	Ratchet
83009	500 lbs.	1,500 lbs.	Black	10'	1"	S-hook	Rubber-coated	2	Ratchet
83010	500 lbs.	1,500 lbs.	Black	16'	1"	S-hook	Rubber-coated	4	Ratchet
83019	733 lbs.	2,200 lbs.	Blue	16'	1"	J-hook	Rubber-coated	1	Ratchet
83020	733 lbs.	2,200 lbs.	Blue	16'	1"	J-hook	Rubber-coated	2	Ratchet
83025	1,100 lbs.	3,300 lbs.	Orange	16'	1"	J-hook	Rubber-coated	1	Ratchet
83026	1,100 lbs.	3,300 lbs.	Orange	16'	1"	J-hook	Rubber-coated	2	Ratchet
83027	1,100 lbs.	3,300 lbs.	Lime green	16'	1"	S-hook	Rubber-coated	1	Ratchet
83028	1,100 lbs.	3,300 lbs.	Lime green	16'	1"	S-hook	Rubber-coated	2	Ratchet
83036	1,667 lbs.	5,000 lbs.	Yellow	14'	1 1/2"	J-hook	Yellow zinc-plated	1	Ratchet
83047	3,333 lbs.	10,000 lbs.	Yellow	27'	2"	J-hook	Yellow zinc-plated	1	Ratchet
83048	3,333 lbs.	10,000 lbs.	Yellow	27'	2"	Flat hook	Yellow zinc-plated	1	Ratchet

RINGS & TIE-DOWN ANCHORS

See page 343 for
part number table

Recessed rope rings

- Recessed design eliminates obstruction and provides a finished look
- Adds a convenient anchor point for ropes, bungee cords or straps
- Perfect for cargo management in trailers, trucks and vans
- Constructed from high-strength steel
- Protected by a durable zinc-plated finish
- Mounting screws not included



83601



83710



83600

D-rings

- Square holes accept 3/8" carriage bolts (#83740 and #83742)
- Adds a convenient anchor point for ropes, bungee cords or straps
- Perfect for cargo management in trailers, trucks and vans
- Constructed from high-strength steel
- Mounting screws not included



83740



83742



83730



83732



83731

Lashing rings

- Adds a heavy-duty anchor point for ropes, cables, straps or chains
- Perfect for heavyweight cargo management in trailers, trucks and vans
- Raw finish allows for ready welding of mounting bracket
- Large opening offers a reliable anchoring point
- Constructed from high-strength, forged steel



83750



83760



83770



83780



Shown on trailer

Backing plate

- Allows for more secure attachment of tie-down anchors
- Constructed from high-strength steel
- Compatible with #83600, #83740 and #83742
- Mounting screws not included



83607



83740 & 83607



83600 & 83607

Trim ring

- Provides a clean, finished look for recessed plate #83710
- Helps protect plate edges from damage and corrosion
- Constructed from durable black plastic



83720



83710 in 83720

RINGS & TIE-DOWN ANCHORS

Part#	Capacity	Break Strength	Finish	Base Size	Mount Hole Size	Mounting Hole Pattern	Ring I.D.	Ring Thickness
Recessed Rope Rings								
83710	1,000 lbs.	1,000 lbs.	Zinc-plated	3 1/2" x 3 1/2"	1/4"	1 3/16"	1 1/8" x 1 5/8"	1/4"
83601	1,200 lbs.	1,200 lbs.	Zinc-plated	5" x 3 1/2"	1/4"	4 1/16" x 1/4"	1 3/8" x 1 7/8"	1/4"
83600	5,000 lbs.	5,000 lbs.	Zinc-plated	4 7/8" x 4 1/2"	3/8"	3 3/8" x 2 7/8"	1 1/2" x 1 1/2"	1/2"
D-Rings								
83730	1,200 lbs.	1,200 lbs.	Zinc-plated	2 1/4" x 13/16"	1/4"	1 1/2"	1" x 1 1/4"	1/4"
83731*	1,200 lbs.	1,200 lbs.	Zinc-plated	2 1/4" x 13/16"	1/4"	1 1/2"	1" x 1 1/4"	1/4"
83732	1,200 lbs.	1,200 lbs.	Stainless	2 1/4" x 13/16"	1/4"	1 1/2"	1" x 1 1/4"	1/4"
83740	3,600 lbs.	11,000 lbs.	Yellow zinc-plated	1 3/4" x 3 11/16" x 7/8"	7/16"	2"	3" x 3"	1/2"
83742	3,600 lbs.	11,000 lbs.	Zinc-plated	1 3/4" x 3 11/16" x 7/8"	7/16"	2"	3" x 3"	1/2"
Lashing Rings								
83750	6,100 lbs.	18,000 lbs.	Raw steel	2 1/4" x 1 5/8" x 1 1/4"	--	--	3" x 3"	5/8"
83760	8,833 lbs.	26,500 lbs.	Raw steel	2 1/4" x 1 5/8" x 1 1/4"	--	--	3" x 3"	3/4"
83770	15,587 lbs.	46,760 lbs.	Raw steel	2 1/4" x 2 1/8" x 1 3/4"	--	--	3" x 3"	1"
83780	15,587 lbs.	46,760 lbs.	Raw steel	2 1/4" x 2 1/8" x 1 3/4"	--	--	3" x 4"	1"
Backing Plate and Trim Ring								
83607	--	--	Gloss black	6" x 6"	7/16"	3" x 3 1/4" (2" center)	--	--
83720	--	--	Plastic	--	--	--	3" x 3"	3/8"

* Packaged two-pack



CARGO MANAGEMENT

PACK IT UP AND LOCK IT DOWN

From weekend getaways to week-long excursions, CURT cargo management products give your customers the extra space and increased security to pack what they want. Our bike racks and cargo carriers add convenient storage room to any vehicle, using the hitch receiver tube. Your customers can also keep their cargo secure with our full line of cargo straps, tie-down anchors, waterproof cargo bags, cargo nets and hitch locks. Don't make them pack light. Equip your customers to Bring It® with CURT.

FEATURED PRODUCTS



Tray-style bike racks

Our tray-style bike racks are redesigned with a lockable, ratcheting system to keep bikes more secure than ever during travel.



Basket-style cargo carriers

Equipped with 6" tall sides, basket-style cargo carriers keep items fully secure and are available with a raised or folding shank.



Waterproof cargo bags

Available for our hitch-mounted and roof rack cargo carriers, these cargo bags help protect items from water, wind and even theft.

PRODUCT INDEX



346

Hitch-Mounted
Cargo Carriers



348

Roof Rack
Cargo Carrier



349

Cargo
Bags & Nets



350

Tray-Style
Bike Racks



351

Hitch-Mounted
Bike Racks



354

Clamp-on
Bike Rack



355

Bike Rack
Accessories



356

Extenders
& Adapters



357

Specialty
Mounts



357

Reducer
Sleeves



358

Cargo
Straps



360

Rings & Tie-
Down Anchors

1 1/4
INCH

&

2
INCH

TRAY-STYLE CARGO CARRIERS

- Frees up space inside the vehicle for passengers and cargo
- Easily bolts together for quick assembly
- Folding design allows carrier to be tilted up when not in use
- Mesh base for easy cleanup
- Features mounting holes for a cargo net or bungees
- #18100 is constructed from lightweight aluminum (shank made from powder-coated steel)
- Protected by a highly durable E-coat and carbide black powder coat finish



Easy-to-store fold-away design

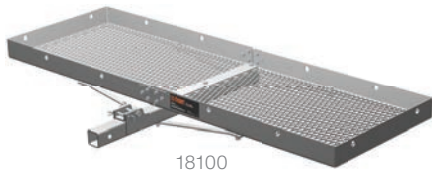

18100



18108



18108
rear view



18109



18110

Pkg#	Capacity	Dimensions	Shank Size	Shank	Finish	Material	Adapter Included
18100*	500 lbs.	60" x 20" x 2 3/4"	2" x 2"	Folding	Raw aluminum basket with a powder-coated shank	Aluminum basket with a steel shank	No
18108	500 lbs.	60" x 20" x 2 3/4"	2" x 2"	Fixed	Carbide	Steel	No
18109*	500 lbs.	60" x 20" x 2 3/4"	2" x 2"	Folding	Carbide	Steel	No
18110	300 lbs.	48" x 20" x 2 3/4"	1 1/4" x 1 1/4"	Fixed	Carbide	Steel	Yes
			2" x 2"				

* Rear-mounted spare tire may interfere with the folding feature

1 1/4
INCH

&

2
INCH

BASKET-STYLE CARGO CARRIERS

- 6" tall sides keep items more secure during travel
- Frees up space inside the vehicle for passengers and cargo
- Constructed from heavy-duty, tubular steel
- Folding shank allows carrier to be tilted up when not in use
- Angled shank elevates carrier for more ground clearance
- Mesh base for easy cleanup
- Built-in reflectors add visibility for increased safety
- Easily accepts a cargo bag, cargo net or bungees
- Protected by a highly durable E-coat and carbide black powder coat finish



Easy-to-store fold-away design



Frees up space inside the vehicle



18150



18151



18145



18152



18153



18153
rear view

Pkg#	Capacity	Dimensions	Shank Size	Shank	Finish	Material	Adapter Included
18150	500 lbs.	60" x 20" x 6"	2" x 2"	Fixed	Carbide	Steel	No
18151*	500 lbs.	60" x 20" x 6"	2" x 2"	Folding	Carbide	Steel	No
18152	500 lbs.	60" x 24" x 6"	2" x 2"	Fixed	Carbide	Steel	No
18153*	500 lbs.	60" x 24" x 6"	2" x 2"	Folding	Carbide	Steel	No
18145	500 lbs.	48" x 20" x 6"	1 1/4" x 1 1/4"	Fixed	Carbide	Steel	Yes
			2" x 2"				

*Rear-mounted spare tire may interfere with the folding feature

ROOF RACK CARGO CARRIER

- Frees up space inside the vehicle for passengers and cargo
- Mounts to most roof rack base rails
- Easily accepts a cargo bag, cargo net or bungees
- Lightweight and easy to install with included mounting brackets
- Two-piece design easily bolts together for quick assembly
- Protected by a durable E-coat and carbide black powder coat finish



Mounts to most roof rack base rails



Frees up space inside the vehicle



18115



18117

Pkg#	Capacity	Inside Dimensions	Storage Area	Finish	Material	Description
18115	Limited to vehicle	41 1/2" (L) x 37" (W) x 4" (H)	10 5/8 square feet	Carbide	Steel	Roof basket
18117	Limited to vehicle	21" (L) x 37" (W) x 4" (H)	Adds 5 3/8 square feet	Carbide	Steel	Extension

UNIVERSAL ATV CARGO CARRIER

- Universal design fits most ATV cargo racks
- 6" tall sides keep items more secure during travel
- Lightweight for easy installation and use
- Mesh base for easy cleanup
- Constructed from heavy-duty, tubular steel
- Protected by a highly durable E-coat and carbide black powder coat finish
- Includes universal mounting hardware
- White box with full-color retail label



18101

Pkg#	Capacity	Finish	Material	Dimensions
18101	Limited to ATV	Carbide	Steel	41" x 26" x 6 1/4"



Easy installation



Secures cargo



Adds extra space

CARGO BAGS

- Keeps cargo protected from water, dirt, wind damage and more
- Made from thick, 500 x 500 denier, UV-resistant vinyl
- Features welded seams to be truly waterproof
- Zip closure with hook-and-loop flap keeps inside completely dry
- Zippers feature large holes to accept a padlock
- Tie-down straps securely attach to cargo carrier frame



18210



18211



18220



18221



Waterproof exterior keeps cargo dry



Secure zip closure, hook-and-loop flap



Easily folds up for compact storage



Fits into CURT roof rack cargo carriers



Fits into most CURT cargo carriers



Pkg#	Dimensions	Storage	Straps	Description	Yarn Count	Weight	Thickness
18210	56" x 18" x 21"	12.25 cubic feet	6	Cargo carrier bag	500 denier	600 grams per square meter	0.45mm - 0.55mm
18211	56" x 22" x 21"	15.00 cubic feet	6	Cargo carrier bag			
18220	38" x 34" x 18"	13.50 cubic feet	4	Roof rack cargo carrier cargo bag			
18221	59" x 34" x 18"	21 cubic feet	6	Roof rack cargo carrier cargo bag			

CARGO NETS

- Secures cargo from dislodging during travel
- Provides more reliable security than bungee cords
- Attachment hooks feature holes for easy handling
- Elastic netting fits over a variety of cargo
- Durable, netted storage bag



Secures cargo from dislodging during travel



Hook holes for easy handling



18202

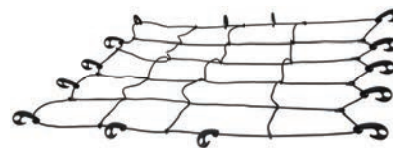

18200

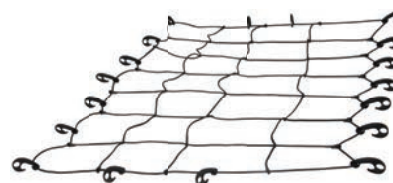

18201



Pkg#	Dimensions	Fits
18202	43" x 24"	60" wide carriers
18200	44" x 38"	Roof rack cargo carrier
18201	65" x 38"	Extended roof rack cargo carrier



Any bike rack used with a 1 1/4" receiver tube requires the use of a support strap (CURT #18050). Failure to use a support strap may void the warranty of the trailer hitch and / or bike rack.

1 1/4
INCH & **2**
INCH

TRAY-STYLE HITCH-MOUNTED BIKE RACKS

- Tray-style arms provide three points of contact to keep bikes fully secure
- Ratcheting arms lock down onto the frames and will not loosen during travel
- Key-operated ratchets also deter theft while the vehicle is left unattended
- Highly adjustable arms easily accommodate various bike sizes and styles
- Padded arms protect the bike frames from nicks and scratches
- Tray-style design allows for easy loading and unloading of bikes
- Threaded anti-wobble shank prevents bikes from swaying during travel
- Tilts away for convenient rear vehicle access
- Sides fold up when not in use for compact storage
- Protected by a durable black powder coat finish
- **Do not install on a trailer or other towed vehicle**



Pkg#	Number of Bikes	Max Load	Shank Size	Extendable
18085 NEW	2	90 lbs.	1 1/4" x 1 1/4" 2" x 2"	No
18087 NEW	4	180 lbs.	2" x 2"	Yes



Tilts away for rear vehicle access



Lockable, ratcheting arms will not loosen



Sides fold up for compact storage



Threaded shank prevents wobble



Removable 2-bike extension



Included adapter fits 2" receiver

TRAY-STYLE BIKE RACK CRADLES FOR FAT TIRES

- 4 7/8" inside width accepts most types of fat bike tires
- Replaces existing cradles
- Durable black powder coat finish
- Includes two cradles for holding one bike



Designed to replace existing cradles



18091

Pkg#	Fits	Inside width
18091	CURT Tray-style bike racks	4 7/8"

2 INCH PREMIUM HITCH-MOUNTED BIKE RACKS

- Tapered arms accommodate multiple bike sizes, including kids' bikes
- Adjustable rubber cradles will not scratch bike frames
- Tilts away for convenient rear vehicle access
- Arms fold down when not in use for compact storage
- Threaded anti-wobble shank prevents bikes from swaying during travel
- Built-in reflectors for added safety
- Protected by a durable black powder coat finish
- **Do not install on a trailer or other towed vehicle**



Tilts away for rear vehicle access



Threaded shank prevents wobble

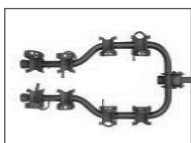

Tapered arms fit a range of bike sizes



Adjustable rubber cradles



Towable shank allows use of the bike rack while towing a trailer, see page 353 for details



18063



18064



18065

Pkg#	Number of Bikes	Max Bike Capacity	Shank Size	Towable Shank
18063	3	135 lbs.	2" x 2"	Compatible, not included
18064	4	180 lbs.	2" x 2"	Compatible, not included
18065	5	225 lbs.	2" x 2"	Not compatible

BIKE RAKE REPLACEMENT STRAPS

- Fastens to the bike rack cradles to secure bikes for travel
- Multiple holes allows for easy adjustment for different bike frame tube sizes
- Rubber construction will not scratch bike frames



18007 installed



18007

Part#	Fits
18007 NEW	CURT standard and premium hitch-mount bike racks



Any bike rack used with a 1 1/4" receiver tube requires the use of a support strap (CURT #18050). Failure to use a support strap may void the warranty of the trailer hitch and / or bike rack.

1 1/4" & 2" HITCH-MOUNTED BIKE RACKS

See page 353 for bike rack part numbers

- Adapter sleeve allows mounting on either 1 1/4" or 2" receiver tube (#18029, #18030, #18033, #18034)
- Towable shank allows use of the bike rack while towing a trailer (#18031 and #18035)
- 3/4" trailer ball hole accepts any trailer ball with a 3" shank (CURT #40016 recommended)
- Adjustable rubber cradles will not scratch bike frames
- Tilts away for convenient rear vehicle access
- Arms fold down when not in use for compact storage
- Threaded anti-wobble shank helps prevent bikes from swaying during travel
- Bolt-together post for compact storage
- Protected by a durable black powder coat finish
- Compact package makes part numbers #18029 and #18030 retail-friendly
- **Do not install on a trailer or other towed vehicle**



Tilts away for rear vehicle access



Adjustable rubber cradles



Threaded shank prevents wobble



Support strap included



Removable arm extenders save space



Bolt-together post for compact storage



Towable shank allows use of the bike rack while towing a trailer



1 1/4
INCH

&

2
INCH

HITCH-MOUNTED BIKE RACKS

Pkg#	Number of Bikes	Max Bike Capacity	Shank Size	Towable Shank	Towable Shank GTW / TW	Extendable
Hitch-Mounted Bike Racks						
18029	2	90 lbs.	1 1/4" x 1 1/4" 2" x 2"	Compatible, not included	--	No
18030	2 or 4	90 / 180 lbs.	1 1/4" x 1 1/4" 2" x 2"	Compatible, not included	--	Yes
18033	3	135 lbs.	1 1/4" x 1 1/4" 2" x 2"	Compatible, not included	--	No
18034	4	180 lbs.	1 1/4" x 1 1/4" 2" x 2"	Compatible, not included	--	No
Towable Hitch-Mounted Bike Racks						
18031	2 or 4	90 / 180 lbs.	2" x 2"	Included	2,000 / 200 lbs.	Yes
18035	4	180 lbs.	2" x 2"	Included	2,000 / 200 lbs.	No

2
INCH

TOWABLE BIKE RACK SHANK

- Allows for easy towing of a trailer while using a bike rack
- Fits trailer hitches with a 2" x 2" receiver tube opening
- Bike rack tilts away for rear vehicle access
- 3/4" trailer ball hole accepts any trailer ball with a 3" shank (CURT #40016 recommended)
- Hollow shank accepts an anti-rattle kit to prevent wobble
- Constructed from high-strength steel
- Bike rack and trailer ball not included



Tow a trailer while using the bike rack



18008

Part#	Shank Size	GTW / TW	Finish
18008	2" x 2"	2,000 / 200 lbs.	Gloss black





Any bike rack used with a 1 1/4" receiver tube requires the use of a support strap (CURT #18050). Failure to use a support strap may void the warranty of the trailer hitch and / or bike rack.

2 INCH CLAMP-ON BIKE RACK

- Clamps onto any 2" x 2" ball mount shank (ball mount not included)
- Adjustable rubber cradles will not scratch bike frames
- Easily accessible release handle allows for fast installation and removal
- Protected by a durable black powder coat finish
- Includes support straps
- **Do not install on a trailer or other towed vehicle**



Fits 2" x 2" ball mount shank



Adjustable rubber cradle



Support strap included



Easily accessible release handle



18013

Pkg#	Number of Bikes	Max Load
18013	3	135 lbs.

BOLT-ON BIKE RACK

- Bolts onto any trailer ball tongue with a 3/4" diameter hole (ball mount not included)
- Tilts away for convenient rear vehicle access
- Rubber-coated arms will not scratch bike frames
- Features a lockable arm for added security
- Protected by a durable black powder coat finish
- **Do not install on a trailer or other towed vehicle**

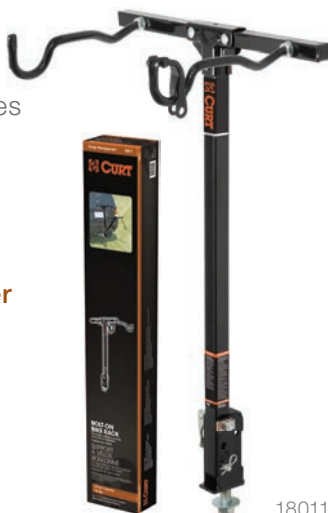

18011

Pkg#	Number of Bikes	Max Load	Bolt Size
18011	2	70 lbs.	3/4"

BIKE BEAM

- Allows bike with angled frame to be used on bike rack
- Compatible with various bike frames
- Extends from 22 1/2" to 31" to accommodate multiple bike sizes
- Made with high-strength steel construction



Helps mount angled-frame bikes



18016

Pkg#	Length	Finish
18016	Extends from 22 1/2" to 31"	Black

MULTI-USE CABLE LOCK

- Secures bike racks and cargo to deter theft
- Features versatile locking and cinching capabilities
- 6' length allows for great use as a bike lock
- Made of 3/8" high-strength braided steel cable
- Protected by a vinyl coating for rust resistance
- Includes two keys for added convenience



Locks bikes to deter theft



23666

Pkg#	Length	Cable	Finish
23666	6'	3/8" diameter	Vinyl-coated, braided steel

BIKE RACK SUPPORT STRAP

- Provides added stability and support for a hitch-mounted bike rack
- Features a generous 61" length
- Required for all 1 1/4" hitch-mounted bike racks (Recommended for all hitch-mounted bike racks)
- Failure to use a support strap with a 1 1/4" bike rack may void the warranty of the trailer hitch and bike rack



Supports 1 1/4" hitch-mounted racks



18050

Pkg#	Dimensions
18050	1" wide by 61" long

ANTI-RATTLE HITCH PINS

- Stops rattling and prevents swaying of load when using a hollow shank
- Compatible with CURT cargo carriers and other hollow-shank accessories
- Threaded pin allows bracket to be tightly installed



22315



22321

Pkg#	Fits Receiver Tube Opening	Finish
22315	1 1/4" x 1 1/4"	Yellow zinc-plated
22321	2" x 2"	Yellow zinc-plated

TRAY-STYLE BIKE RACK LOCKING KNOBS

- Locking knobs are designed to replace existing knobs
- Includes two keys for added convenience
- Compatible with CURT #18084 and #18086 only
- Includes two knobs per package



18090

Pkg#	Fits
18090*	18084 and 18086 tray-style bike racks

*Continued while supplies last

1 1/4 INCH & 2 INCH TRAILER HITCH RECEIVER TUBE EXTENDERS

- Provides added clearance for a trailer or hitch-mounted accessory
- Shank constructed from solid steel for optimum strength
- Protected by a durable powder coat finish



Part#	Extends	Shank Size	GTW / TW
45789	7"	1 1/4"	Not for towing use / 350 lbs.
45791	8"	2"	3,500 / 350 lbs.
45795	14"	2"	3,500 / 350 lbs.
45796	18"	2"	3,500 / 350 lbs.

Measuring extenders and adapters

Length is measured between pin-holes, from center to center



1 1/4 INCH ↔ 2 INCH ← 2 1/2 INCH TRAILER HITCH RECEIVER TUBE ADAPTERS

- Adapts a receiver tube opening to a different size
- #45048 can be cut down from 34" to 24" and has integrated safety chain loops and an electrical bracket
- Protected by a durable powder coat finish



Part#	Adapts From	Adapts To	GTW / TW	Weight Dist. GTW / TW	Length	Finish
45785	1 1/4"	2"	Not for towing use / 350 lbs.	--	6 1/4"	Gloss black
45790	1 1/4"	2"	Not for towing use / 350 lbs.	--	10"	Gloss black
45770	2"	1 1/4"	3,500 / 350 lbs.	--	4"	Gloss black
45775	2"	1 1/4"	3,500 / 350 lbs.	--	9 1/2"	Gloss black
45780	2"	1 1/4"	3,500 / 350 lbs.	--	15"	Gloss black
45013	Vertical 2"	Standard 2"	5,000 / 500 lbs.	--	4 1/4"	Gloss black
45048	2 1/2"	2"	4,500 / 450 lbs.	6,000 / 600 lbs.	34"	Gloss black
			6,000 / 600 lbs.	8,000 / 800 lbs.	24"	

2 INCH SPECIALTY MOUNTS

 Weight capacities limited to the lowest rated towing component

- Fits any 2" x 2" receiver tube opening
- Top receiver increases ground clearance for a cargo carrier or other hitch-mounted accessories
- Top receiver not for towing use
- Provides two receiver tubes for multiple accessories, such as a cargo carrier and a ball mount (#45792)
- Ideal for carrying a bike rack while towing a trailer (#45810)



45794



45792



45794 gives added ground clearance



45792 provides two receiver tubes



45810 provides a ball mount and receiver tube to tow a trailer and an additional accessory



45810

Part#	Description	GTW / TW	Drop	Rise	Length	Hole Size	Finish
45794	Raised receiver adapter	Not for towing use / 350 lbs.	--	4 1/4"	5 1/4"	--	Gloss black
45792	Dual receiver extender with pin & clip	3,500 / 350 lbs.	--	5 13/16"	8"	--	Gloss black
45810	Multi-use ball mount with pin & clip	7,500 / 750 lbs.	2"	5 13/16"	12 1/4"	1"	Gloss black

3 INCH → 2 1/2 INCH → 2 INCH REDUCER SLEEVES

- #45405 reduces a 2 1/2" x 2 1/2" receiver tube opening to fit a 2" x 2" shank
- #45408 set reduces a 3" x 3" receiver tube opening to fit a 2 1/2" x 2 1/2" shank or 2" x 2" shank
- Protected by a durable carbide powder coat finish
- GTW and TW are limited to trailer hitch capacity

How to use a reducer sleeve



Part#	Reduces From	Reduces To	Length	Finish
45405	2 1/2"	2"	5 1/2"	Carbide
45408 NEW	3"	2 1/2"	6 1/4"	Carbide
	2 1/2"	2"		

NEW



45405



45408



45408 set

CARGO STRAPS

- Perfect for securing cargo in trailers, truck beds and more
- Offers a superior tie-down method compared to bungee cords and rope
- Cambuckle mechanism allows for direct tension on lighter loads
- Ratchet mechanism allows for greater tension on heavy loads
- Straps constructed from high-strength, woven nylon
- Cinching components protected by a durable yellow zinc-plated finish



Secures cargo better than bungee cords or rope



83036



83047



83048



83015



83016



83001



83002



83009



83010



83019



83020



83025



83026



83027



83028

Pkg#	Work Load	Break Strength	Strap Color	Strap Length	Strap Width	Hook Style	Hook Finish	Strap Quantity	Mechanism
83015	300 lbs.	900 lbs.	Dark green	15'	1"	S-hook	Rubber-coated	2	Cambuckle
83016	300 lbs.	900 lbs.	Dark green	16'	1"	S-hook	Rubber-coated	4	Cambuckle
83001	500 lbs.	1,500 lbs.	Red	10'	1"	S-hook	Rubber-coated	2	Ratchet
83002	500 lbs.	1,500 lbs.	Red	16'	1"	S-hook	Rubber-coated	4	Ratchet
83009	500 lbs.	1,500 lbs.	Black	10'	1"	S-hook	Rubber-coated	2	Ratchet
83010	500 lbs.	1,500 lbs.	Black	16'	1"	S-hook	Rubber-coated	4	Ratchet
83019	733 lbs.	2,200 lbs.	Blue	16'	1"	J-hook	Rubber-coated	1	Ratchet
83020	733 lbs.	2,200 lbs.	Blue	16'	1"	J-hook	Rubber-coated	2	Ratchet
83025	1,100 lbs.	3,300 lbs.	Orange	16'	1"	J-hook	Rubber-coated	1	Ratchet
83026	1,100 lbs.	3,300 lbs.	Orange	16'	1"	J-hook	Rubber-coated	2	Ratchet
83027	1,100 lbs.	3,300 lbs.	Lime green	16'	1"	S-hook	Rubber-coated	1	Ratchet
83028	1,100 lbs.	3,300 lbs.	Lime green	16'	1"	S-hook	Rubber-coated	2	Ratchet
83036	1,667 lbs.	5,000 lbs.	Yellow	14'	1 1/2"	J-hook	Yellow zinc-plated	1	Ratchet
83047	3,333 lbs.	10,000 lbs.	Yellow	27'	2"	J-hook	Yellow zinc-plated	1	Ratchet
83048	3,333 lbs.	10,000 lbs.	Yellow	27'	2"	Flat hook	Yellow zinc-plated	1	Ratchet

FOLD-AWAY ROPE HOOK

- Adds a convenient anchor point for ropes, bungee cords or straps
- Perfect for cargo management in trailers, trucks and vans
- Fold-away design eliminates obstruction and provides a finished look
- Protected by a durable chrome-plated finish
- Includes mounting hardware



Folds out as needed and folds away to be completely unobtrusive

83060

83061

Bulk#	Pkg#	Capacity	Finish
83060	83061	1,200 lbs.	Chrome-plated

WELD-ON STAKE POCKET

- Adds a tie-down point for cargo straps and transport binder chains
- Perfectly sized to accept a 2x4 wood or metal stud
- Raw finish allows for immediate welding
- Made in the USA

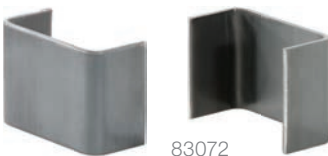

83072

Part#	Finish	Inside Width	Inside Depth
83072	Raw	3 1/2"	1 5/8"

RINGS & TIE-DOWN ANCHORS

See page 361 for
part number table

Recessed rope rings

- Recessed design eliminates obstruction and provides a finished look
- Adds a convenient anchor point for ropes, bungee cords or straps
- Perfect for cargo management in trailers, trucks and vans
- Constructed from high-strength steel
- Protected by a durable zinc-plated finish
- Mounting screws not included



83601



83710



83600

D-rings

- Square holes accept 3/8" carriage bolts (#83740 and #83742)
- Adds a convenient anchor point for ropes, bungee cords or straps
- Perfect for cargo management in trailers, trucks and vans
- Constructed from high-strength steel
- Mounting screws not included



83740



83742



83730



83732



83731

Lashing rings

- Adds a heavy-duty anchor point for ropes, cables, straps or chains
- Perfect for heavyweight cargo management in trailers, trucks and vans
- Raw finish allows for ready welding of mounting bracket
- Large opening offers a reliable anchoring point
- Constructed from high-strength, forged steel



83750



83760



83770



83780



Shown on trailer

Backing plate

- Allows for more secure attachment of tie-down anchors
- Constructed from high-strength steel
- Compatible with #83600, #83740 and #83742
- Mounting screws not included



83607



83740 & 83607

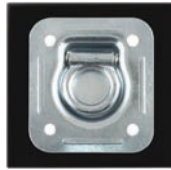

83600 & 83607

Trim ring

- Provides a clean, finished look for recessed plate #83710
- Helps protect plate edges from damage and corrosion
- Constructed from durable black plastic



83720



83710 in 83720

RINGS & TIE-DOWN ANCHORS

Part#	Capacity	Break Strength	Finish	Base Size	Mount Hole Size	Mounting Hole Pattern	Ring I.D.	Ring Thickness
Recessed Rope Rings								
83710	1,000 lbs.	1,000 lbs.	Zinc-plated	3 1/2" x 3 1/2"	1/4"	1 3/16"	1 1/8" x 1 5/8"	1/4"
83601	1,200 lbs.	1,200 lbs.	Zinc-plated	5" x 3 1/2"	1/4"	4 1/16" x 1/4"	1 3/8" x 1 7/8"	1/4"
83600	5,000 lbs.	5,000 lbs.	Zinc-plated	4 7/8" x 4 1/2"	3/8"	3 3/8" x 2 7/8"	1 1/2" x 1 1/2"	1/2"
D-Rings								
83730	1,200 lbs.	1,200 lbs.	Zinc-plated	2 1/4" x 13/16"	1/4"	1 1/2"	1" x 1 1/4"	1/4"
83731*	1,200 lbs.	1,200 lbs.	Zinc-plated	2 1/4" x 13/16"	1/4"	1 1/2"	1" x 1 1/4"	1/4"
83732	1,200 lbs.	1,200 lbs.	Stainless	2 1/4" x 13/16"	1/4"	1 1/2"	1" x 1 1/4"	1/4"
83740	3,600 lbs.	11,000 lbs.	Yellow zinc-plated	1 3/4" x 3 11/16" x 7/8"	7/16"	2"	3" x 3"	1/2"
83742	3,600 lbs.	11,000 lbs.	Zinc-plated	1 3/4" x 3 11/16" x 7/8"	7/16"	2"	3" x 3"	1/2"
Lashing Rings								
83750	6,100 lbs.	18,000 lbs.	Raw steel	2 1/4" x 1 5/8" x 1 1/4"	--	--	3" x 3"	5/8"
83760	8,833 lbs.	26,500 lbs.	Raw steel	2 1/4" x 1 5/8" x 1 1/4"	--	--	3" x 3"	3/4"
83770	15,587 lbs.	46,760 lbs.	Raw steel	2 1/4" x 2 1/8" x 1 3/4"	--	--	3" x 3"	1"
83780	15,587 lbs.	46,760 lbs.	Raw steel	2 1/4" x 2 1/8" x 1 3/4"	--	--	3" x 4"	1"
Backing Plate and Trim Ring								
83607	--	--	Gloss black	6" x 6"	7/16"	3" x 3 1/4" (2" center)	--	--
83720	--	--	Plastic	--	--	--	3" x 3"	3/8"

* Packaged two-pack



The **FIRST** Name
in Towing Products™



MARKETING MATERIALS

FULLY SUPPORTING YOUR BUSINESS

We believe in providing our customers with the highest quality products and fully supporting the sale of those products in-store and online. For in-store sales, we offer signage, display stands and literature to draw in more traffic and help your customers make an informed buying decision. We also have a large selection of planogram options. For online sales, we offer extensive image, video and content libraries available for your use. To use these resources on your website, please talk to your sales rep.

FEATURED PRODUCTS



Literature

Like our catalog, CURT literature is attractive and informative, giving your customers key information about each product line.



Banners

Promotional banners target your customers' lifestyle and draw traffic to your store with bold graphics and clear messaging.



Display stands

Displays are available for several products, including hitches, bike racks and accessories. Many are also free with certain purchases.

PRODUCT INDEX



364
Custom
Planograms



364
Promotional
Items



365
Literature
& Catalog



365
Window
Stickers



366
Banners
& Posters



367
Retail Signage
& Headers



368
Display Stands
& Signage



373
Gondola
Displays

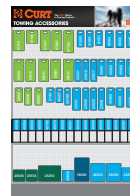

374
Pre-Designed
Planograms

PLANOGRAMS

Custom planograms

CURT offers custom planogram services tailored to your needs. Contact your CURT sales representative to discuss the questions listed below. Together we will create a unique planogram to perfectly complement the layout of your store. We will help you answer the following questions:

- Which categories or products should I display?
- Which display fixtures should I use?
- How many shelves are included?
- How much area will the planogram cover?
(Example: 48" wide by 72" tall)

Pre-designed planograms

CURT also offers pre-designed planograms to fit various retail needs. Layouts and pricing are available upon request. Please contact your sales representative.



OUT-OF-STOCK PEG TAGS

- Place behind your product to easily identify where CURT product should be restocked

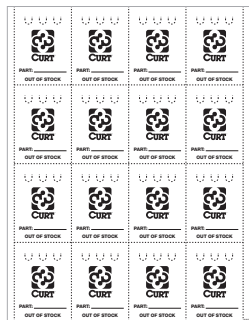

99139
full sheet



Individual tag

Part#	Description
99139	Sheet of 16 out-of-stock peg tags

PROMOTIONAL ITEMS

- Great for in-store use or to give away to customers



99035



99037



99100

Part#	Description
99035	Pen with CURT and ARIES logos
99037	Koozie with CURT and ARIES logos
99100	Laser-cut vinyl CURT logo, 5" wide

TRIFLEX™ BRAKE CONTROL COUNTERTOP DISPLAY

Part#	Requirements for a Free Display	Dimensions
99073*	Buy six 51140 TriFlex™ brake controls (Includes 12 of CURT 99074)	10" x 8" x 9 3/4"
99260	Extra brake control display brochure	3 1/2" x 8 1/2"

* Continued while supplies last



99073



99260

LITERATURE & CATALOG

- Tri-fold literature focuses on educating the consumer about the advantages of CURT's product lines
- Complete listing of CURT products and their vehicle-specific applications (#99270)
- Tri-fold: 8 1/2" x 3 1/2" finished size

Part#	Description	Content
Literature		
99067	Tri-fold	Trailer hitches
99088	Tri-fold	TruTrack™ weight distribution
99089	Tri-fold	Gooseneck hitches
99106	Tri-fold	RV towing
99260 NEW	Tri-fold	Brake controls
99261 NEW	Tri-fold	Cargo management
99262 NEW	Tri-fold	OEM puck system products
99263 NEW	Tri-fold	Towing electrical
99264 NEW	Tri-fold	Ball mounts
99265 NEW	Tri-fold	Towing accessories
Catalog		
99270 NEW	Catalog	2018 product listing and application guide



99067



99260



99261

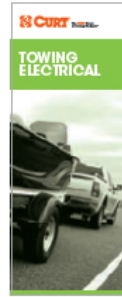

99263



99265

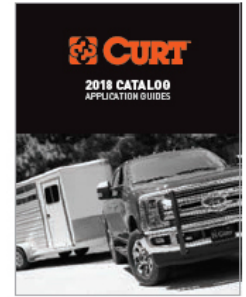

99270

LITERATURE HOLDERS

- Clear plastic stands to display CURT literature
- Sticker available for CURT brand awareness



99129



99137



99194

Part#	Description	Dimensions
99129	Single-tier, tri-fold literature holder	8 1/2" x 3 1/2"
99137	Logo sticker for literature holder	3" x 2"
99123	T-base adhesive sign holder	6" x 2" x 1 1/2"
99194	T-base adhesive sign holder	6" x 3/4" x 3/4"

WINDOW STICKERS

- Double-sided, adhesive window stickers to help promote CURT



99133



99191



99043

Part#	Description	Dimensions
99043	'CURT sold and installed here'	30" x 9"
99133	'CURT sold and installed here'	8" x 6"
99134	'CURT sold and installed here', French	8" x 6"
99191	'CURT sold here'	8" x 6"

PROMOTIONAL BANNERS

- Bold graphics and clear lifestyle messaging to draw attention to your store
- Various options designed to promote your CURT product offering



99042



99125



99128

Part#	Category	Content	Dimensions
99042	CURT brand	CURT logo only	5' x 2'
99125	Trailer hitches	Towing somewhere? Trailer hitches sold and installed here	5' x 2'
99128	RV towing products	Looking to get away? RV towing products sold & installed here	5' x 2'
99170	5th wheel hitches	Going off the grid? 5th wheel hitches sold and installed here	5' x 2'
99171	Gooseneck hitches	Getting your hands dirty? Gooseneck hitches sold and installed here	5' x 2'
99126	Trailer hitches, French	On se tire d'ici? Vente et installation d'attelages sur place	5' x 2'
99127	RV towing products, French	On cherche à s'en tirer? Nous vendons et installons des produits de remorquage pour vr	5' x 2'



99170



99171

PROMOTIONAL POSTERS

- Show off CURT product offerings while educating your customers



99124



99132



99174

Part#	Description	Dimensions
99124	Towing lifestyle	36" x 24"
99132	Trailer hitches	36" x 24"
99174	Double Lock EZr™ gooseneck hitch	36" x 24"

RETAIL SIGNAGE

- Attractive, single-sided counter mats help staff promote CURT (#99266 or #99267)
- Are you a 'CURT Professional Installer'? Let your customers know! (#99141 or #99269)
- For use on EZr™ gooseneck hitch displays (#99173)



99141 & 99269



99266



99267

Part#	Description	Promotes	Dimensions
99141	Outdoor sign	'Professional Hitch Installer' (metal)	24" x 18"
99269	Outdoor sign	'Professional Hitch Installer' (plastic)	24" x 18"
99266 NEW	Counter mat	Trailer hitches and accessories	18" x 12"
99267 NEW	Counter mat	Heavy-duty towing (5th wheel, gooseneck and WD)	18" x 12"
99173*	Table tent	Double Lock EZr™ gooseneck hitch	6" x 9" x 4"

* Continued while supplies last



99173

RETAIL HEADER CARDS

- Attractive header cards for use above your planograms
- Help your customers identify CURT product categories and connect them to towing lifestyles



99040



99048

Part#	Description	Dimensions
99009	Custom order trailer hitches	48" x 8"
99040	Hitches available	48" x 8"
99048	Towing electrical with sub-categories	48" x 8"
99052	Towing accessories, French	48" x 8"
99053	Hitches available, French	48" x 8"

Part#	Description	Dimensions
99122	Product categories (for endcap)	36" x 10"
99146*	Trailer balls	48" x 8"
99148	Towing accessories	48" x 8"
99150*	Towing security	48" x 8"

* Continued while supplies last

Receive free display stands by fulfilling the purchase requirements listed.
 Contact your sales representative for ordering information. Signage must be ordered separately.

TRAILER HITCH DISPLAY STAND, SIGNAGE & TUBE ADAPTERS

- Contact your CURT sales representative to determine the best hitch lineup tailored to your needs
- Accepts trailer hitches with 2" x 2" receiver tubes
- Quickly adapt the CURT #99143 trailer hitch stand to accept 1 1/4" or 2 1/2" receiver tube trailer hitches



99144



99157



99095



99145



99050



99143

Part#	Description / Requirements for a Free Display	Dimensions
Display Stand		
99143	Buy five hitches, five ball mounts and five pins & clips	--
Signage		
99144	Front mount trailer hitch sign for 99143	42" x 14"
99145	Trailer hitch sign for 99143	42" x 14"
99050	Trailer hitch sign for 99143, French	42" x 14"
Receiver Tube Adapters		
99157	Adapts 1 1/4" x 1 1/4" receiver tube openings to fit 2" x 2" (ball mount and pin & clip included)	--
99095	2 1/2" x 2 1/2" receiver tube openings to fit 2" x 2" (designed for CD and CD+ hitches)	--

5TH WHEEL HITCH DISPLAY STANDS & SIGNAGE

- For use with CURT A-series and Q-series 5th wheel hitches (#99156)
- Adapters required for A-series 5th wheel hitches. See table below.
- For use with CURT E16 5th wheel hitch (#99160)
- For use with all CURT R-series 5th wheel rollers (#99158)

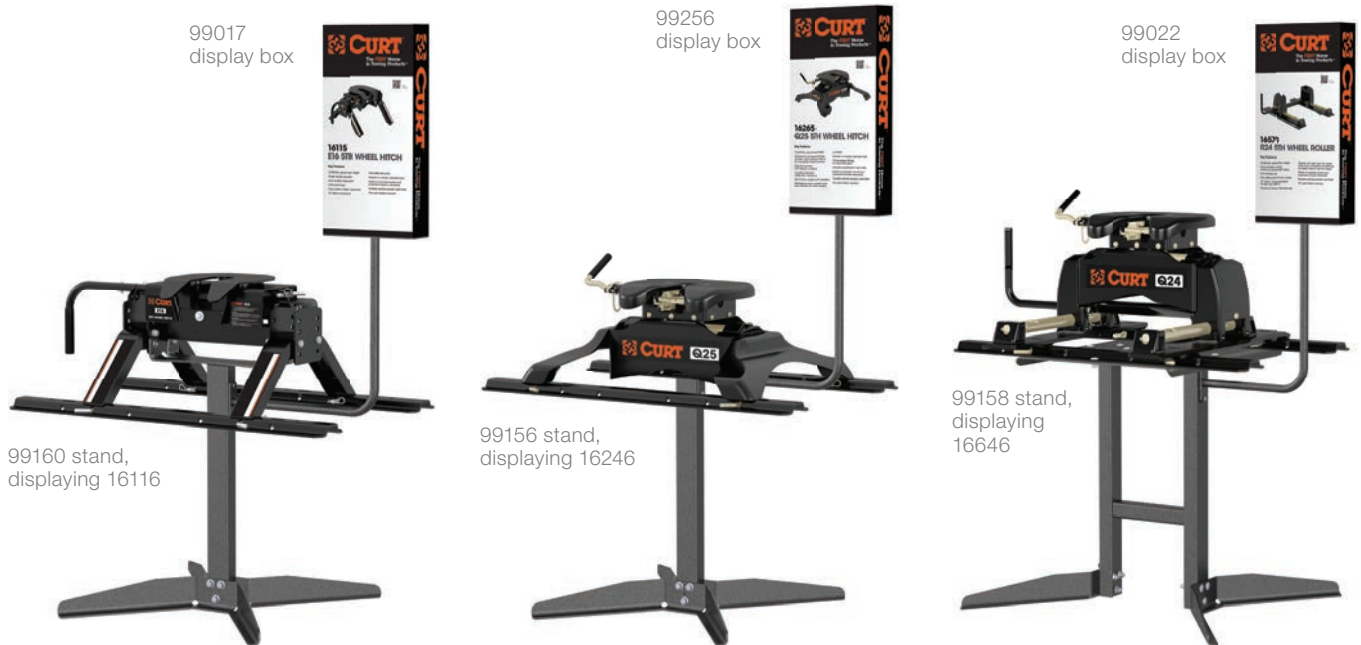

Part#	Description / Requirements for a Free Display	Dimensions
Display Stands		
99160	Buy four E16 5th wheels with rails (one for display, three for stock)	--
99156	Buy three Q-series 5th wheel hitches with rails (one for display, two for stock)	--
99183	A16 display adapter plate (Required to mount A16 5th wheel hitch to 99156 display)	--
99257	A20 and A25 display adapter plate (Required to mount A20 and A25 5th wheel hitches to 99156 display)	--
99158	Buy any two 5th wheel rollers (one for display, one for stock)	--
Signage		
99017	E16 5th wheel box sign for 99160	12 1/2" x 5" x 26"
99019	Q20 5th wheel box sign for 99156	12 1/2" x 5" x 26"
99021	Q24 5th wheel box sign for 99156	12 1/2" x 5" x 26"
99256	Q25 5th wheel box sign for 99156	12 1/2" x 5" x 26"
99236	Q20 and Q24 5th wheel box sign for 99156, French	12 1/2" x 5" x 26"
99184	A16 5th wheel box sign for 99156	12 1/2" x 5" x 26"
99258	A20 5th wheel box sign for 99156	12 1/2" x 5" x 26"
99259	A25 5th wheel box sign for 99156	12 1/2" x 5" x 26"
99233	Ford 5th wheel legs box sign for 99156	12 1/2" x 5" x 26"
99018	R16 roller box sign for 99158	12 1/2" x 5" x 26"
99020	R20 roller box sign for 99158	12 1/2" x 5" x 26"
99022	R24 roller box sign for 99158	12 1/2" x 5" x 26"



99183



99257

Receive free display stands by fulfilling the purchase requirements listed.
Contact your sales representative for ordering information. Signage must be ordered separately.

GOOSENECK DISPLAY STANDS & SIGNAGE

- For use with select CURT gooseneck hitches
See the table below for compatible gooseneck part numbers (#99180)
- Shows both the CURT Spyder and bent plate
5th wheel rail gooseneck hitches at the same time (#99159)

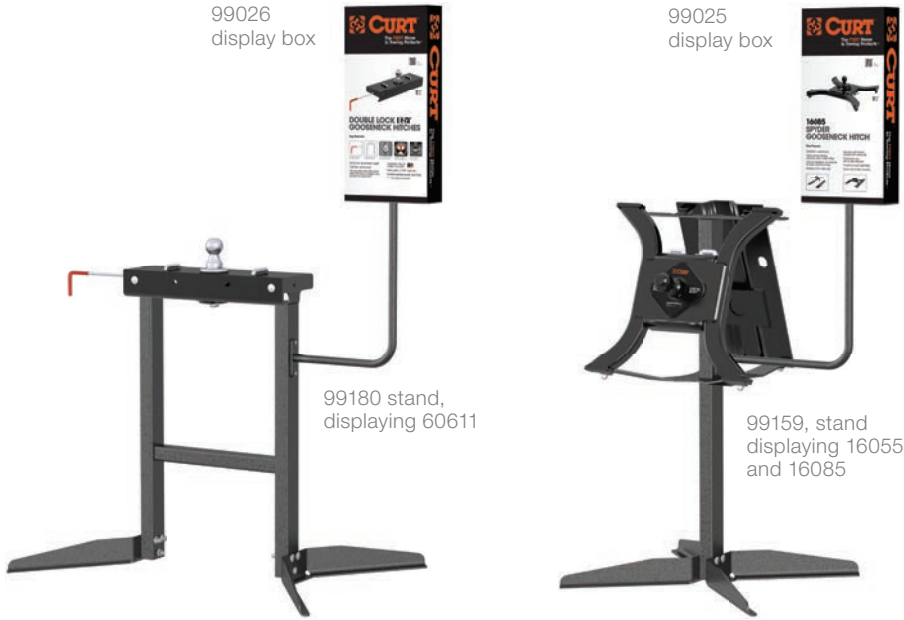

Part#	Description / Requirements for a Free Display	Dimensions
Display Stand		
99180	Buy four gooseneck hitches (one for display, three for stock) Compatible parts: 60607, 60611, 60619, 60630	--
99159	Buy three 16055 and three 16085 (one each for display, two each for stock)	--
Signage		
99026	Double Lock and EZr™ gooseneck box sign for 99180	12 1/2" x 5" x 26"
99237*	Double Lock and EZr™ gooseneck box sign for 99180, French	12 1/2" x 5" x 26"
99027	X5 5th wheel adapter plate box sign for 99180	12 1/2" x 5" x 26"
99025	Bent plate and Spyder goosenecks box sign for 99159	12 1/2" x 5" x 26"
Note: 60615, 60620, 60625 and 60640 do not fit the 99180 display stand		
*Continued while supplies last		

WEIGHT DISTRIBUTION DISPLAY STANDS & SIGNAGE

- Double-stack design allows for easy comparison between models (#99254)
- For use with all CURT weight distribution hitches
- Coupler accepts a 2 5/16" trailer ball (#99254)
- Receiver tube accepts 2" x 2" shanks (#99246)
- #99255 sign is included



Part#	Description / Requirements for a Free Display	Dimensions
Display Stands		
99254	Double-stack display Buy any four WD units, two for display, two for stock	--
99246*	Low-rise weight distribution display stand	--

* Continued while supplies last

CARGO CARRIER DISPLAY STAND & SIGNAGE

- For use with CURT cargo carriers
- Double-sided display

Part#	Desc. / Requirements for Free Display	Dimensions
Display Stand		
99152	Buy any eight 2" shank cargo carriers (four for display, four for stock)	--
Signage		
99153	Cargo carriers sign for 99152	42" x 14"



Receive free display stands by fulfilling the purchase requirements listed.
Contact your sales representative for ordering information. Signage must be ordered separately.

CARGO STRAP DISPLAY STAND & SIGNAGE

- For use with CURT cargo straps
- Includes display stand and peg hooks
- See page 358 for cargo straps



99209



99194



99193

Part#	Description	Dimensions
99193	Cargo strap display stand kit	--
99209	Cargo strap sign for 99193	23 1/2" x 6"

BIKE RACK DISPLAY STANDS & SIGNAGE

- For use with all CURT bike racks
- Includes five receiver tubes on each side of the display for multiple bike rack configurations (#99154)



99012 display sign

99039 stand, displaying 18030, 18065 and 18034



99155 display sign

99154 stand, displaying 18030, 18065 and 18034

Part#	Requirements for a Free Display	Dimensions
Display Stands		
99039	Single-sided display / Buy any three bike racks with a shank	--
99154*	Double-sided display / Buy any five bike racks with a shank	--
Signage		
99012	Bike rack sign for 99039	30" x 9 1/2"
99155*	Bike rack sign for 99154	42" x 14"

* Continued while supplies last

GONDOLA DISPLAYS

- All part numbers listed below fit Lozier gondola displays
- Use pegboard header cards listed on page 367

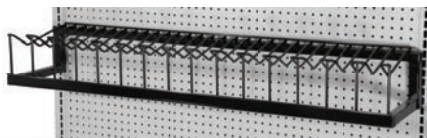

99028
empty

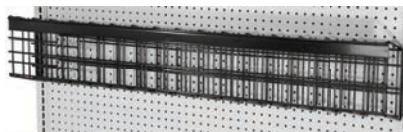

99015
empty



99028
loaded

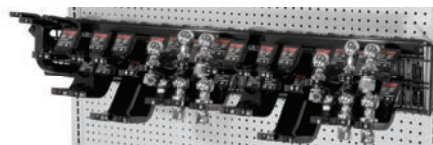

99015
loaded

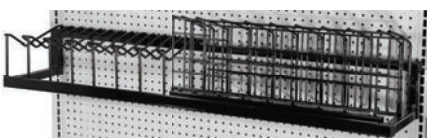

99029
empty



99162
empty



99029
loaded



99162
loaded



99030



99031

Part#	Description	Requirements for a Free Display	Notes	Dimensions
99028	Trailer ball Lozier grid rack	Buy any 30 bulk trailer balls	Holds up to 45 trailer balls	Use with 4' wide Lozier fixtures
99015	Ball mount Lozier grid rack	Buy any 20 ball mounts	Holds up to 32 ball mounts	Use with 4' wide Lozier fixtures
99029	Ball mount and trailer ball Lozier grid rack	Buy any 15 bulk trailer balls and any 10 ball mounts	Holds up to 21 trailer balls and 18 ball mounts	Use with 4' wide Lozier fixtures
99162	Ball mount Lozier fork rack	Buy any 45 ball mounts	Features 15 pegs to display various ball mounts	Use with 4' wide Lozier fixtures
99030	Foot jack Lozier shelf brackets	Buy any two foot-equipped jacks	Almond finish	--
99031	Overhead Lozier hitch brackets	Buy one 13514 trailer hitch	Black finish	--

PRE-DESIGNED PLANOGRAMS

CURT has arranged several different pre-designed planograms to provide a convenient retail solution ready to be implemented in your store. The designs are based on popular product arrangements and are organized to be easy for your customers to navigate.

Please contact your sales representative for more information about sizes and options or to discuss custom planogram options.

4 EXAMPLE PLANOGRAM

FOOT

- 4' x 5 1/2' pre-designed planogram
- See pages 367 and 373 for retail header cards and gondola displays
- See your sales representative for more information

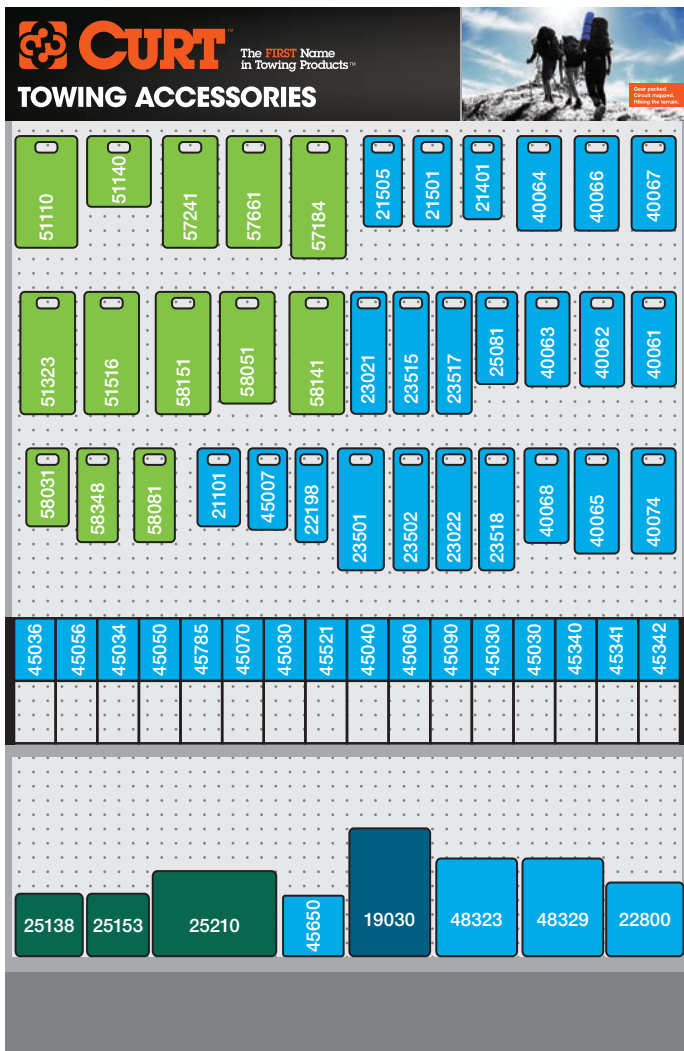

Product Category Color Guide

The icons below represent the CURT product line, with each color representing a specific product category. Retail packaging is also colored accordingly, keeping CURT planograms in your store well-organized and allowing your customers to find items more easily.



8 FOOT EXAMPLE PLANOGRAM

- 8' x 5 1/2' pre-designed planogram
- See pages 367 and 373 for retail header cards and gondola displays
- See your sales representative for more information

TOWING ACCESSORIES

TOWING ELECTRICAL

Sub-categories for TOWING ELECTRICAL: BRAKE CONTROLS, CUSTOM WINCH, RV HARNESSES, ELECTRICAL CONVERTERS, PULSE & SOCKETS, ELECTRICAL AMPLIFIERS, ACCESSORIES & TESTERS.

Product SKUs displayed on the planogram include:

- TOWING ACCESSORIES (Blue):** 21505, 21404, 21401, 21501, 21511, 21411, 21502, 40061, 40062, 40063, 40064, 22198, 23515, 23517, 23518, 23519, 23502, 23528, 23501, 23022, 23503, 23521, 23520, 40065, 40066, 40067, 40068, 45007, 23530, 23510, 23021, 23527, 25081, 23546, 40069, 40074, 40081, 40072, 21101, 45036, 45056, 45034, 45050, 45785, 45070, 45030, 45521, 45040, 45060, 45090, 45030, 45050, 45340, 45341, 45342, 45650, 45824, 48190, 48200, 48210, 48323, 48329, 48339.
- TOWING ELECTRICAL (Green):** 51120, 51140, 51323, 51333, 51516, 51353, 56146, 57183, 57241, 58151, 58051, 58141, 58081, 58048, 58031, 57672, 57261, 57184, 57251, 58000, 58003, 58001, 58261, 58261, 57661, 80011, 80031, 80136, 80151.
- Other Categories (Tan, Maroon, Grey-Blue, Dark Green, Brown):** 45002, 45900, 19030, 52044, 52042, 60609, 60618, 25138, 25153, 29433, 29435, 29438.

TRAILER HITCHES LISTED NUMERICALLY

Part#	Yrs From	Yrs To	Make / Model / Style	Repl By
11000	2010	2014	VOLKS GTI	--
	2010	2014	VOLKS GOLF	--
11001	2010	2016	MERCEDES E350 SED	--
11002	2010	2015	HONDA ACCORD CROSSTOUR	--
11005	1997	2002	SATURN SC, SL, SW COUPE/SED	--
11006	2007	2012	DODGE CAL 4DR LIFT BACK	--
11008	1992	1996	MITSU DIAMANTE	--
11010	1993	1999	VOLKS JETTA & WOLFSBURG	--
11011	1993	1999	VOLKS GOLF HATCH	--
11012	1994	1998	MITSU GALANT	--
11013	2010	2014	CAD CTS SPORT WAGON	--
	2012	2013	CAD CTS-V WAGON	--
11014	1997	2001	HONDA CRV	--
11017	2010	2012	LEXUS HS 250H	--
11019	2010	2013	KIA FORTE KOUP	--
11020	2008	2015	SMART FORTWO	--
11022	2010	2012	SUZUKI KIZASHI	--
11023	2010	2013	ACURA ZDX	--
11024	1999	2005	CHEV/GMC TRACK, SUZ VITARA	--
11025	2011	2014	HYUNDAI SONATA, INCL HYBRID	--
	2011	2015	KIA OPTIMA	--
11027	1995	2000	CHRYSLER CIRUS	--
	1995	2006	DODGE STRATUS	--
	1995	2000	PLYMOUTH BREEZE	--
11028	2006	2015	MAZDA MIATA MX-5 W/ POWER RETRACT HARDTOP	--
11030	2008	2011	MERCEDES C-CLASS SED	--
11031	2007	2010	KIA RONDO ALL	--
11033	2006	2011	BMW 325I	--
	2007	2011	BMW 328XI SED	--
	2007	2010	BMW 335XI SED	--
11034	1997	2001	CHEV/GMC CORVETTE	--
11036	1995	2001	CHEV/GMC GEO HATCH	--
11037	2008	2016	AUDI A5 COUPE W/ SINGLE MUF AUDI A5 QUATTRO COUPE W/ SINGLE MUFFLER	--
11038	1994	2010	DODGE PLYMOUTH	--
11039	2000	2005	DODGE NEON	--
11140	2006	2011	SAAB 9-3 SPORT COMBI WAGON W/ DUAL EXHAUST	--
11041	1994	2004	FORD MUSTANG	--
11047	2010	2013	LEXUS IS 250C CONVERT	--
11048	2010	2011	FORD MUSTANG	--
11050	2007	2015	TOYO YARIS LIFTBACK	--
11051	2010	2014	HONDA INSIGHT	--
11054	1998	2005	VOLKS PASSAT SED, EXCL 4MO	--
	1998	2005	VOLKS PASSAT WAG, EXCL 4MO	--
11055	2011	2012	FORD FIESTA SED	--
11057	1987	2000	JEEP WRANGLER	--
11058	2007	2008	HONDA FIT 5DR	--
11060	2006	2011	TOYO YARIS 4DR	--
11061	2011	2011	FORD MUST 5.0L CONVER ONLY	11048
11064	2009	2013	HONDA FIT 5DR	--
11065	2011	2013	VOLVO C70 T5 CONVERT	--
11066	1998	2010	VOLKS BEETLE	--
	2007	2009	VOLKS GOLF CITY (CAN ONLY)	--
	1999	2006	VOLKS GOLF HATCH	--
	1999	2005	VOLKS GTI 2DR HATCH	--
11067	2011	2016	FORD FIESTA HATCH	--
11068	2009	2013	INFINITI G37 CONVERT	--
	2014	2014	INFINITI Q60 CONVERT	--
11070	1999	2005	VOLKS JETTA SED	--
11072	2010	2014	VOLKS GOLF WAGON	11474
	2005	2016	VOLKS JETTA SED, EXCL TDI	--
	2009	2014	VOLKS JETTA SPORTWAGEN	--
11073	2011	2105	MAZDA 2	--
11074	2006	2009	VOLKS GTI	--
	2006	2009	VOLKS RABBIT	--
11076	2000	2005	VOLKS PASSAT 4-MOTION	--
11077	2011	2016	HONDA CR-Z	--
11079	2000	2002	VOLKS CABRIOLET CONVERT	--
11080	2006	2011	HYUNDAI AZERA SED	--
11081	2007	2010	CHRYSLER SEBRING SED	--
	2008	2010	DODGE AVENGER, ALL	--
11083	2001	2005	VOLKS JETTA WAGON	--
11085	2008	2012	HONDA ACCORD	--
	2011	2014	ACURA TSX SPORTWAGON	--
11086	2010	2016	HYUNDAI GENESIS COUPE	--

Part#	Yrs From	Yrs To	Make / Model / Style	Repl By
11087	2011	2013	SCION TC	--
11088	2011	2017	NISSAN JUKE S, AWD	--
	2011	2017	NISSAN JUKE SL, AWD	--
	2011	2017	NISSAN JUKE SV, AWD	--
11090	2007	2016	VOLKS EOS CONVERT, HARD TOP & SUN ROOF	--
11091	2012	2012	VOLKS CC EXECUTIVE	--
	2014	2015	VOLKS CC EXECUTIVE	--
	2013	2013	VOLKS CC LUX	--
	2012	2012	VOLKS CC LUX LTD	--
	2012	2012	VOLKS CC LUX PLUS	--
	2009	2011	VOLKS CC LUXURY	--
	2011	2016	VOLKS CC R-LINE	--
	2016	2017	VOLKS CC R-LINE EXECUTIVE	--
	2009	2017	VOLKS CC SPORT	--
	2013	2013	VOLKS CC SPORT PLUS	--
	2016	2016	VOLKS CC TREND	--
	2009	2010	VOLKS CC VR6	--
	2009	2010	VOLKS CC VR6 SPORT	--
	2006	2011	VOLKS PASSAT	--
11092	2006	2011	KIA RIO 5 HATCH	--
	2006	2011	HYUNDAI ACCENT HATCH	--
11094	2006	2011	KIA RIO 4DR	--
	2006	2011	HYUNDAI ACCENT 4DR	--
11096	2007	2010	VOLKS PASSAT WAGON, EXCL 3.6L 4MOTION	--
11099	2007	2009	VOLKS RABBIT	11074
11103	2007	2010	JEEP GRAND CHEROKEE SRT8	--
11105	1991	1999	FORD ESCORT	--
11106	2001	2004	FORD ESCAPE	--
11108	1991	1994	CHEV/GMC CAVALIER, EXCL Z24	--
11109	1995	2006	CHEV/GMC CAVALIER	--
	1995	2006	PONTIAC SUNFIRE	--
11110	2010	2013	KIA SOUL	--
11111	2011	2013	INFINITI M37X SED	--
	2014	2017	INFINITI Q70	--
11112	2008	2010	SATURN ASTRA 3-DR HATCH	--
	2008	2010	SATURN ASTRA 5DR HATCH	--
11113	1995	2000	FORD CONTOUR	--
11114	2007	2009	SATURN SKY REDLINE	--
11115	2003	2007	SATURN ION	--
11117	1982	2002	CHEV/GMC CAMARO	--
11119	2006	2009	PONTIAC SOLSTICE	--
	2007	2009	SATURN SKY	--
11120	2008	2011	SUBARU IMPREZA W/ QUAD EXH	--
	2012	2014	SUBARU IMPREZA HATCH WRX & WRX STI ONLY	--
11122	2010	2013	CHEV/GMC CAMARO	--
11124	2011	2013	KIA FORTE HATCH	--
11126	2002	2006	MINI COOPER HARD TOP EXCL S	--
	2005	2008	MINI COOPER CONVERT EXCL S	--
	2012	2015	MAZDA 5 HATCH	--
11128	1989	1998	CHEV/GMC TRACKER	--
11129	1989	1996	BUICK CENTURY	--
11130	2005	2010	MINI COOPER S HARDTOP	--
	2005	2010	MINI COOPER S CONVERT	--
11132	2000	2010	CHRYSLER PT CRUISE	--
11133	2011	2014	CHRYSLER 200	--
	2011	2014	DODGE AVENGER	--
11134	2011	2014	SCION XD	--
11138	2008	2009	PONTIAC G8	--
	2012	2015	CHEV CAPRICE	--
	2014	2017	CHEV SS	--
11141	1996	2005	TOYO RAV4	--
11143	1990	1991	ACURA INTEGRA HATCH	--
11145	1992	1993	ACURA INTEGRA HATCH	--
11146	1991	1997	TOYO PREVIA	--
11147	1994	2001	ACURA INTEGRA HATCH	--
11148	1996	1999	HYUNDAI ELANTRA	--
11150	1989	1995	MAZDA MPV	--
11153	1991	1995	ACURA LEGEND	--
11154	2002	2004	ACURA RSX HATCH	--
11155	1996	1998	ACURA TL SED	--
11158	2012	2012	FORD FOCUS SEL	--
	2017	2017	FORD FOCUS SEL	--
	2012	2017	FORD FOCUS S	--
	2012	2017	FORD FOCUS SE	--
	2012	2017	FORD FOCUS TITANIUM	--

Part#	Yrs From	Yrs To	Make / Model / Style	Repl By
11159	1996	2004	ACURA RL SED	--
11160	2009	2010	MINI COOPER CONVERT	--
	2007	2011	MINI COOPER HARD TOP	--
11164	2002	2006	AUDI A4 AVANT	--
	2002	2008	AUDI A4 SED	--
	2004	2008	AUDI S4 WAGON	--
11166	1999	2005	AUDI ALL ROAD WAGON	--
11167	1992	1994	AUDI 100/200/5000	--
	1995	1998	AUDI A6 SED & WAGON	--
11169	1998	2001	AUDI A4 SED & WAGON	--
11172	1996	1998	BMW 5 SERIES SED	--
11174	2000	2005	BMW 300 SERIES SED & WAG	--
11177	1994	1999	BMW 300 SERIES CONVERT, COUPE & SED	--
11178	2000	2004	BMW 3 SERIES CONVERT	--
11179	1999	2003	BMW 500 SERIES SED & WAGON, EXCL. M VERSION	--
11180	2007	2008	AUDI A4 AVANT 2.0 QUATTRO	--
11181	1993	2002	CHEV/GMC PRIZM	--
11182	2006	2007	BMW 530XI WAGON	--
11184	2008	2011	BMW 1 SERIES COUPE & CONV	--
11185	1996	2000	CHRYSLER SEBRING	--
11186	2009	2016	AUDI A4 QUATTRO SED	--
11187	2001	2002	DODGE AVENGER	--
	1995	2002	DODGE STATUS COUPE	--
	2010	2010	AUDI A5 CONVERT	--
	2008	2010	AUDI A5 COUPE	--
11188	2008	2016	AUDI A5 COUPE W/ DUAL MUF	--
	2010	2016	AUDI A5 CONVER W/ DUAL MUF	--
	2008	2016	AUDI A5 QUATTRO COUPE W/ DUAL MUFFLER	--
	2008	2016	AUDI A5 QUATTRO CONVERT W/ DUAL MUFFLER	--
11189	2011	2013	MERCEDES E350 WAGON	--
11190	2001	2006	CHRYSLER SEBRING	--
11191	1990	1994	EAGLE TALON	--
	1990	1994	MITSU ECLIPSE	--
11192	2006	2013	AUDI A3 SPORT BACK	--
11193	1995	1999	MITSU ECLIPSE	--
11194	2008	2010	BMW 535XI AWD SPORT SERIES WAGON	--
11195	2009	2013	AUDI A4 AVANT QUATTRO	--
	2013	2016	AUDI ALLROAD	--
11196	2011	2015	CAD CTS COUPE	--
11197	2012	2014	AUDI A7 QUATTRO BASE, GAS MODELS ONLY	--
	2015	2016	AUDI A7 QUATTRO PREMIUM PLUS, GAS MODELS ONLY	--
	2015	2016	AUDI Q7 QUATTRO PRESTIGE, GAS MODELS ONLY	--
11198	2004	2009	HONDA S2000 CONVERT	--
11199	2004	2009	AUDI A8	--
11200	2011	2017	LEXUS CT200H	--
11201	1990	1993	HONDA ACCORD	--
11202	2009	2014	NISSAN CUBE	--
11203	1994	1997	HONDA ACCORD	--
11204	2001	2005	HONDA CIVIC COUP, SED, HATCH	--
11205	1994	1997	HONDA ACCORD WAGON	--
11206	2002	2004	HONDA CIVIC	--
11207	1997	2000	ACURA EL 1.6	--
	1992	2000	HONDA CIVIC SED & COUPE, EXCL DELSOL	--
11208	1992	1998	HONDA PRELUDE	--
11209	1992	2000	HONDA CIVIC	--
11210	2011	2014	FORD MUST COUPE, CONVERT	--
11211	1995	1998	HONDA ODYSSEY	--
	1995	1998	ISUZU OASIS	--
11212	2000	2003	HONDA S2000 CONVERT	--
11213	2012	2012	HYUNDAI ACCENT SED	11250
11214	1995	2005	HYUNDAI ACCENT SED & HATCH	--
11215	1991	1995	HYUNDAI SCOUPE	--
	1990	1993	MITSU PRECIS HATCH	--
	1990	1994	HYUNDAI EXCEL HATCH & SED	--
11216	1999	2001	HYUNDAI SONATA	--
	2001	2006	OPTIMA SED	--
11217	1989	1994	HYUNDAI SONATA	--
11218	1997	2001	HYUNDAI TIBURON	--
11219	1995	1998	HYUNDAI SONATA	--

Part#	Yrs From	Yrs To	Make / Model / Style	Repl By
11220	2001	2006	HYUNDAI ELANTRA SED, HATCH	--
11221	2011	2015	CHEV VOLT	--
11222	2011	2015	CHEV CAMARO CONVERT	--
11223	1990	1991	LEXUS ES250 SED	--
	1986	1991	TOYO CAMRY SED, WAG, ALLTR	--
	1986	1989	TOYO CELICA HATCH	--
	1989	1992	TOYO COROLLA 2WD	--
	1990	1992	TOYO SUPRA HATCH	--
11224	1999	2002	INFINITI G20 SED	--
11225	1992	1996	LEXUS ES300/350 SED	--
11227	1989	1992	GEO PRIZM SED & HATCH	--
	1990	1994	LEXUS LS400	--
	1990	1999	TOYO CELICA ALL FWD, CONVE	--
	1987	1992	TOYO COROLLA SED	--
	1988	1992	TOYO COROLLA 4WD	--
	1987	1988	TOYO COROLLA 2WD	--
	1987	1990	TOYO TERCEL INCL 4WD	--
11228	1992	1996	TOYO CAMRY SED & WAGON	--
11232	2012	2015	VOLKS PASS SED EXCL DIESEL	--
11233	1992	2000	LEXUS SC300/400 COUPE	--
11234	2012	2016	VOLKS PASSAT	--
11235	1991	1994	MAZDA PROTÉGÉ 2WD SED	--
11237	1995	1998	MAZDA PROTÉGÉ	--
11238	1998	2005	LEXUS GS300/400/430 SED	--
11239	1983	1992	MAZDA 626 SED & MX6	--
11240	2012	2017	CHEV SONIC LS, SED	--
	2012	2017	CHEV SONIC LT, SED	--
	2012	2016	CHEV SONIC LTZ, SED	--
	2017	2017	CHEV SONIC PREMIER, SED	--
	2015	2016	CHEV SONIC RS, SED	--
11241	1993	2002	MAZDA 626	--
	1993	1997	MAZDA MX6	--
11242	1998	2004	KIA SEPHEA	--
	2000	2004	KIA SPECTRA	--
11243	1992	1998	MAZDA 929 SED	--
11244	1997	2002	MITSU DIAMANTE SED	--
11245	1992	1992	EAGLE SUMMIT WAGON	--
	1992	1995	MITSU EXPO & EXPO LRV	--
	1992	1994	PLYMOUTH VISTA VAN	--
11246	2000	2005	MITSU ECLIPSE, ALL	--
11248	1999	2003	MITSU GALANT SED	--
11249	2002	2003	MAZDA PROTÉGÉ 5 HATCH, 5DR	--
11250	2012	2017	HYUNDAI ACCENT	--
	2012	2017	KIA RIO SED	--
11251	1993	2001	NISSAN ALTIMA SED	--
11253	1989	1994	NISSAN MAXIMA SED	--
11254	2012	2016	HYUNDAI VELOSTER	--
11255	1995	1995	NISSAN MAXIMA SED	--
11256	2012	2017	NISSAN VERSA SED	--
11257	1991	1994	NISSAN SENTRA ALL INCL SE-R	--
11258	2012	2016	CHEV SONIC LS, HATCH	--
	2012	2016	CHEV SONIC LT, HATCH	--
	2012	2016	CHEV SONIC LTZ, HATCH	--
11259	1995	1996	NISSAN 200SX COUPE	--
	1995	1996	NISSAN SENTRA SED	--
11260	2012	2015	VOLKS BEETLE, EXCL. ADBLUE TANK MODEL	--
11261	1997	1998	NISSAN 200SX COUPE	--
	1997	1999	NISSAN SENTRA SED	--
11262	2012	2017	KIA RIO HATCH	--
11263	2000	2006	NISSAN SENTRA SED	--
11264	2004	2008	NISSAN MAXIMA SED	--
	2002	2006	NISSAN ALTIMA SED	--
11265	2003	2017	TOYO COROLLA	--
11267	2006	2008	BMW 7 SERIES SED	--
11270	2012	2012	VOLKS BEETLE TURBO	11354
11272	2012	2013	MINI COOPER HATCH, EXCL S	--
11275	1987	1994	SUBARU WAG 2&4WD, INCL LOY	--
11276	2010	2011	TOYO PRIUS	--
	2012	2015	TOYO PRIUS & PRIUS PLUG-IN	--
	2012	2017	TOYO PRIUS V	--
11277	1986	1995	SUZUKI SAMURAI	--
11278	2012	2015	CHEV ORLANDO	--
11280	2003	2007	SUBARU BAJA	--
11281	2013	2016	DODGE DART	--
11282	2011	2015	CHEV CRUZE, EXCL DIESEL	--
	2012	2017	BUICK VERANO EXCL DUAL EXH	--
11283	1993	1996	TOYO COROLLA WAGON	--
11285	1992	1995	TOYO PASEO	--
11286	2012	2015	SUBARU IMPREZA HATCH, EXCL WRX & WRX STI	--
	2013	2015	SUBARU XV CROSSTREK	--
11287	1991	1999	TOYO TERCEL SED & COUPE	--

Part#	Yrs From	Yrs To	Make / Model / Style	Repl By
11289	2000	2005	TOYO ECHO	--
	2000	2005	TOYO CELICA COUPE	--
11290	2001	2003	ACURA CL, CL2.2 COUPE	--
	1999	2003	ACURA TL SERIES	--
	1998	2007	HONDA ACCORD SED & COUPE	--
11291	2012	2015	SCION IQ	--
11292	2001	2003	KIA RIO SED	--
	2002	2005	KIA RIO CINCO WAGON	--
11293	2006	2012	MITSU ECLIPSE	--
11294	2001	2007	FORD FOCUS SED, HATCH	--
11296	2000	2007	FORD FOCUS WAGON	--
11298	2000	2005	SATURN L-SERIES SED & WAG	--
11299	2012	2015	TOYO PRIUS C	--
11300	1999	2003	MAZDA PROTÉGÉ SED	--
11301	2004	2006	CHEV/GMC AVEO SED	--
11302	2011	2017	NISSAN JUKE S, FWD	--
	2011	2017	NISSAN JUKE SL, FWD	--
	2011	2017	NISSAN JUKE SV, FWD	--
11303	2011	2016	HYUNDAI ELANTRA COUPE, SED	--
11304	2012	2017	HYUNDAI AZERA	--
11306	2004	2011	CHEV/GMC AVEO5 HATCH	--
	2009	2009	PONTIAC G3 HATCH	--
11307	2004	2014	CAD CTS	--
	2004	2011	CAD STS	--
11308	2003	2005	MAZDA 6 SED & SPORT WAGON	--
11309	2012	2012	NISSAN LEAF	11396
11310	2002	2005	HYUNDAI SONATA	--
11311	2013	2017	CAD ATS BASE	--
	2013	2017	CAD ATS LUXURY	--
	2013	2017	CAD ATS PERFORMANCE	--
	2013	2017	CAD ATS PREMIUM	--
11312	2005	2008	FORD MUSTANG, EXCL GT	--
11315	2008	2011	SUBARU IMPREZA 2.5I WAG, INCL WRX & OUTBACK SPORT, SINGLE EXHAUST	--
11316	2013	2015	CHEV SPARK	--
11317	2008	2011	SUBARU IMPREZA 2.5I SED	--
	2012	2014	DUAL EXHAUST SUBARU IMPREZA SED WRX & WRX STI ONLY	--
11318	2005	2006	SAAB 9-2X	--
	1993	2007	SUBARU IMPREZA INCL OUTBACK SPORT, WRX, & STI	--
11319	2008	2011	FORD FOCUS S, SE, SES	--
11320	2004	2006	SUZUKI VERONA	--
11321	2004	2008	ACURA TL SERIES SED 2.5 & 3.2	--
11322	2010	2010	TESLA ROADSTER	--
11325	2006	2010	HYUNDAI SONATA	--
11326	2003	2011	SAAB 9-3 SED & CONVERT, SINGLE EXHAUST	--
11328	2013	2015	MITSU LANCER	--
11329	2006	2009	FORD FUSION	--
	2007	2009	LINC MKZ	--
	2006	2009	LINC ZEPHYR	--
	2006	2008	MAZDA 6 SED	--
	2006	2009	MERCURY MILAN	--
11327	2003	2007	HONDA ACCORD SED & COUPE	--
11330	2005	2010	SCION TC	--
11331	2007	2011	CHEV/GMC AVEO SED	--
11333	2011	2016	MINI COOPER COUNTRYMAN	--
11334	2013	2015	CHEV SPARK W/O GROUND EFFECTS, EXCL. EV	--
11336	2005	2012	ACURA RL SED	--
11337	2011	2013	VOLVO C30	--
11338	2006	2010	MAZDA 5 SPORT	--
11339	2002	2008	JAGUAR X-TYPE SED	--
	2005	2005	JAGUAR X-TYPE WAGON	--
11340	2011	2015	MERCEDES E550	--
11344	2005	2011	AUDI A6 SED, WAG, INCL QUATT	--
11347	2012	2016	FIAT 500 ABARTH	--
11348	2007	2011	NISS VERSA S, SL SED, HATCH	--
	2012	2012	NISSAN VERSA HATCH ONLY	--
11349	2013	2016	NISSAN SENTRA FE-S	--
	2013	2014	NISSAN SENTRA FE-SV	--
	2013	2017	NISSAN SENTRA S	--
	2013	2017	NISSAN SENTRA SL	--
	2013	2017	NISSAN SENTRA SV	--
11351	2006	2009	KIA MAGENTA SED (CANADA)	--
	2006	2010	KIA OPTIMA SED	--
11352	2007	2013	NISSAN ALTIMA SED	--
	2014	2017	NISSAN ALTIMA	--
	2009	2014	NISSAN MAXIMA	--
	2016	2017	NISSAN MAXIMA	--

Part#	Yrs From	Yrs To	Make / Model / Style	Repl By
11353	2006	2009	MERCEDES CLK CABRIOLET 350, EXCL CLK 63 BLACK SERIES (723 CHASSIS)	--
11354	2012	2014	VOLKS BEETLE TURBOCHARGE, EXCL ADBLUE TANK	--
	2015	2017	VOLKS BEET EXCL ADBLUE TNK	--
11356	2014	2017	MAZDA 6	--
11357	2008	2013	NISSAN ALTIMA COUPE 3.6L V6, DUAL EXHAUST	--
11358	2013	2017	BUICK ENCORE	--
	2013	2017	CHEV TRAX	--
11359	2009	2013	MAZDA 6 SED	--
11362	2013	2017	LEXUS ES300H	--
	2013	2017	LEXUS ES350	--
11363	2016	2016	FIAT 500 C EASY	--
	2012	2012	FIAT 500 C GUCCI	--
	2012	2017	FIAT 500 C LOUNGE / POP	--
	2013	2017	FIAT 500 E	--
	2016	2016	FIAT 500 EASY	--
	2012	2012	FIAT 500 GUCCI	--
	2012	2017	FIAT 500 LOUNGE / POP	--
	2012	2016	FIAT 500 SPORT	--
	2013	2016	FIAT 500 TURBO	--
11364	2014	2017	FIAT 500L	--
11365	2009	2013	JAGUAR XF SED	--
11366	2013	2017	LEXUS GS350 BASE	--
11367	2014	2016	BMW 228I COUPE	--
	2015	2016	BMW 228I XDRIVE COUPE	--
	2013	2017	BMW 320I / 320I XDRIVE	--
	2012	2013	BMW 325I SED	--
	2014	2017	BMW 328D / 328D XDRIVE	--
	2011	2012	BMW 328I WAGON	--
	2012	2013	BMW 328I SED	--
	2014	2016	BMW 328I	--
	2011	2012	BMW 328I XDRIVE WAGON	--
	2013	2013	BMW 328I XDRIVE SED	--
	2014	2016	BMW 328I XDRIVE WAGON	--
	2014	2016	BMW 335I GT XDRIVE SPT WGN	--
	2013	2015	BMW 335I XDRIVE SED	--
	2016	2017	BMW 340I / 340I XDRIVE	--
	2014	2015	BMW 428I SED	--
	2014	2016	BMW 428I COUPE	--
	2015	2016	BMW 428I GRAN COUPE SPORTS WAGON	--
	2014	2016	BMW 428I XDRIVE COUPE	--
	2014	2015	BMW 428I XDRIVE CONVERT	--
	2015	2015	BMW 428I XDRIVE GRAN COUPE SPORTS WAGON	--
	2015	2016	BMW 435I GRAN COUPE	--
	2014	2016	BMW 435I	--
	2016	2016	BMW 435I COUPE	--
	2014	2014	BMW 435I XDRIVE	--
	2015	2016	BMW 435I XDRIVE COUPE/GRAN	--
11368	2014	2017	KIA FORTE	--
11369	2013	2016	FORD FIESTA SED	--
11370	2007	2012	NISSAN SENTRA	--
11371	2014	2015	CHEV CRUZE DIESEL	--
11372	2006	2006	LEXUS GS300	--
	2007	2011	LEXUS GS350	--
	2006	2006	LEXUS GS430	--
	2006	2009	LEXUS IS250	--
	2010	2013	LEXUS IS250 BASE	--
	2006	2009	LEXUS IS350	--
	2010	2012	LEXUS IS350 BASE	--
11373	2014	2015	CHEV CAMARO COUPE	--
11375	2014	2015	SCION TC	--
11376	2014	2014	MERCEDES SLK250	--
11377	2014	2018	MAZDA 3	--
11378	2014	2017	NISSAN VERSA NOTE	--
11379	2013	2016	SCION FR-S	--
	2013	2017	SUBARU BRZ	--
	2017	2017	TOYO 86	--
11380	2005	2013	CHEV/GMC CORV COUPE, CNVRT	--
11381	2011	2016	535I SED	--
	2011	2016	535I XDRIVE	--
	2011	2016	550I SED	--
	2011	2014	550I XDRIVE SED	--
11382	2014	2015	CAD CTS SED	--
11383	2010	2013	MAZ 3 SDR, INCL SPORT,SPEED	--
11386	2004	2009	MAZDA 3, EXCL MAZDASPEED	--
11387	2008	2014	MINI COOPER CLUBMAN	--

Part#	Yrs From	Yrs To	Make / Model / Style	Repl By
11389	2017	2017	LEXUS IS TURBO	--
	2016	2016	LEXUS IS200T	--
	2014	2015	LEXUS IS250 BASE / F SPORT	--
	2016	2017	LEXUS IS300	--
	2014	2017	LEXUS IS350 BASE / F SPORT	--
11390	2010	2012	FORD FUSION	--
	2010	2012	LINC MKZ SED	--
	2010	2011	MERCURY MILAN	--
11391	2006	2011	ACURA CSX	--
	2013	2017	ACURA ILX	--
	2006	2015	HONDA CIVIC	--
11392	2014	2016	KIA FORTE K0UP	--
11393	2010	2013	MAZDA 3 SED	--
11394	2014	2015	MITSU MIRAGE	--
	2017	2017	MITSU MIRAGE	--
11395	2014	2017	KIA FORTE5	--
11396	2011	2017	NISSAN LEAF	--
11397	1997	2000	ACURA CL, CL2.2 COUPE	--
11398	2013	2016	CHEV SONIC RS	--
11399	2015	2017	AUDI A3 SED	--
	2015	2017	AUDI A3 QUATTRO	--
11400	2013	2017	HYUNDAI ELANTRA GT	--
11402	2015	2018	HYUNDAI SONATA	--
	2016	2018	KIA OPTIMA	--
11403	2015	2017	CHRYSLER 200	--
11404	2014	2016	MERCEDES E350 4MATIC WAGO	--
11405	2015	2017	FORD MUST ECOB PREM COUPE	--
	2015	2017	FORD MUSTANG GT	--
	2015	2015	FORD MUST GT 50 YRS LTD ED.	--
	2015	2017	FORD MUST GT PREM COUPE	--
	2015	2017	FORD MUSTANG V6 COUPE	--
11406	2015	2018	HONDA FIT	--
11407	2014	2018	INFINITI Q50	--
11408	2015	2016	SUBARU IMPREZA SED WRX	--
	2012	2016	SUBARU IMPREZA SED	--
	2015	2018	SUBARU WRX	--
	2015	2018	SUBARU WRX STI	--
11409	2015	2018	ACURA TLX	--
11410	2015	2015	VOLKS JETTA, TDI	--
11411	2015	2015	VOLKS GOLF SPWAG TDI, EXCL. TSI	--
11412	2015	2016	VOLKS GOLF	--
	2015	2017	VOLKS GTI	--
11413	2016	2016	MERCEDES-BENZ AMG E63 S	--
11415	2006	2011	SAAB 9-3 SPORT COMBI WAGO	--
11416	2016	2018	HONDA HR-V	--
11417	2014	2015	MINI COOPER BASE, HATCH, EXCL W SPARE TIRE	--
11418	2016	2018	MAZDA CX-3	--
11419	2014	2017	KIA SOUL	--
11420	2016	2016	SCION IM	--
	2017	2017	TOYO COROLLA IM	--
11421	2016	2016	SCION IA	--
	2017	2017	TOYO YARIS IA	--
11422	2015	2017	VOLKS GOLF SPORTWAGEN	--
	2017	2017	VOLKS GOLF ALLTRACK	--
11423	2012	2016	AUDI A6 & A6 QUATTRO	--
11424	2017	2018	HYUNDAI ELANTRA	--
11425	2016	2016	CHEV CRUZE LTD	--
	2015	2015	CHEV CRUZE ECO, L, LS, LT, LTZ	--
11426	2016	2017	TOYO PRIUS	11473
11427	2005	2012	TOYO AVALON, DUAL EXHAUST	--
11428	2005	2006	KIA SPECTRA 5	11429
11429	2007	2009	KIA SPECTRA 5	--
11430	2005	2010	CHEV/GMC COBALT 2 & 4DR	--
	2005	2009	PONTIAC PURSUIT 2 & 4DR	--
11431	2013	2016	FORD FOCUS ST	--
11432	2005	2005	TOYO ECHO (CAN) EXCL TURBO	--
11433	2016	2017	CHEV SPARK	--
11434	2010	2013	KIA FORTE SED	--
11435	2016	2018	MAZDA MX-5 MIATA	--
11436	2016	2018	CHEV VOLT	--
11438	2004	2011	VOLVO S40 SED	--
	2005	2010	VOLVO V50 WAGON	--
11439	2016	2018	CHEV CRUZE L, LS, LT SEDAN	--
	2017	2108	CHEV CRUZE PREMIER, SED	--
11440	2002	2007	SUZUKI AERIO HATCH	--
11441	2016	2018	BUICK CASCADA	--
11442	2005	2008	SUZUKI RENO	--
11443	2007	2013	SUZUKI SX-4 HATCH	--
11444	2005	2006	NISSAN X-TRAIL (CANADA)	--
11445	2016	2017	HONDA CIVIC COUPE	11463
11446	2008	2013	SUZUKI SX-4 SPORT SED	--

Part#	Yrs From	Yrs To	Make / Model / Style	Repl By
11447	2005	2010	CHEV/GMC COBALT SS 2 & 4DR	--
	2006	2011	CHEV/GMC HHR	--
	2007	2009	PONTIAC G5	--
	2005	2009	PONTIAC PURSUIT GT	--
	2004	2009	SATU ION & ION REDLINE W/2.4L	--
	2000	2005	SATURN L-SERIES SED & WAGO	--
11448	2017	2018	AUDI A4 & A4 QUATTRO	--
	2017	2018	AUDI A4 ALLROAD	--
	2018	2018	AUDI A5 QUATTRO COUPE	--
	2018	2018	AUDI A5 SPORTBACK	--
11449	2017	2017	MITSU MIRAGE G4	--
11450	2004	2006	KIA AMANTI	--
11452	1988	1996	CHEV/GMC BERETTA	--
	1998	1996	CHEV/GMC CORSICA	--
11453	2016	2016	NISSAN MICRA	--
11454	2017	2017	MERCEDES-BENZ E300	--
11455	2004	2008	ACURA TSX	--
11457	2017	2018	CHEV BOLT EV	--
11458	2017	2018	CHEV CRUZE LT HATCH	--
	2017	2018	CHEV CRUZE PREMIER HATCH	--
11460	2004	2006	MITSU GALANT SED	--
11462	2007	2012	MITSU GALANT SED, 2.4L, SINGLE EXHAUST	--
11463	2016	2017	HONDA CIVIC COUPE	--
	2017	2017	HONDA CIVIC EXL, HATCH	--
	2017	2017	HONDA CIVIC EX, HATCH	--
	2017	2017	HONDA CIVIC LX, HATCH	--
11464	2017	2017	CHEV SONIC LT, HATCH	--
	2017	2017	CHEV SONIC PREMIER, HATCH	--
11465	2017	2017	SUBARU IMPREZA HATCH	--
11466	2017	2017	SUBARU IMPREZA SED	--
11467	2007	2010	HYUNDAI ELANTRA SED	--
11468	2004	2009	TOYO PRIUS	--
11471	2009	2012	HYUNDAI ELANTRA TOURING	--
11472	2004	2008	MAZDA RX8	--
11473	2016	2017	TOYO PRIUS	--
	2017	2017	TOYO PRIUS PRIME	--
11474	2005	2017	VOLKS JETTA, EXCL DIESEL	--
	2010	2014	VOLKS GOLF, WAGON (CANADA ONLY), EXCL DIESEL	--
11475	2017	2017	VOLKS GOLF R	--
11476	2005	2006	MITSU LANCE SED, EXCL EVOL	--
11477	2003	2008	HYUNDAI TIBURON	--
11478	2017	2017	BMW 530I & 540I	--
	2017	2017	BMW 530I XDRIVE, 540I XDRIVE	--
11479	2008	2013	MITSU LANCER DE, SING EXHA	--
	2008	2013	MITSU LANCER ES, SING EXHA	--
	2016	2017	MITSU LANCER ES, SING EXHA	--
	2011	2013	MITSU LANCER ES SPRTBACK, SING EXHA	--
	2012	2013	MITSU LANCER GT, SING EXHA	--
	2016	2016	MITSU LANCER GT, SING EXHA	--
	2012	2013	MITSU LANCER GT SPRTBACK, SING EXHAUST	--
	2008	2011	MITSU LANCE GTS, SING EXHA	--
	2010	2011	MITSU LANCER GTS SPRTBACK, SING EXHAUST	--
	2012	2013	MITSU LANCER SE, SING EXHA	--
	2016	2017	MITSU LANCER SE, SING EXHA	--
	2016	2017	MITSU LANCER SEL, SING EXHA	--
11480	2007	2011	TOYO YARIS HATCH	--
	2012	2017	TOYO YARIS ALL	--
11481	2004	2008	CHEV/GMC OPTRA CANADA	--
	2004	2008	SUZUKI FORENZA	--
11482	2003	2006	INFINITI G35 SED	--
11483	2003	2006	INFINITI G35 COUPE	--
	2004	2005	NISSA 350Z EXCL '05 ANNY ED	--
11484	2012	2017	TOYO PRIUS C	--
11485	2015	2017	MERCEDES-BENZ C300 BASE	--
	2015	217	MERCEDES-BENZ C300 4MATIC	--
11486	2017	2017	HYUNDAI IONIQ HYBRID BLUE	--
	2017	2017	HYUNDAI IONIQ HYBRID LTD	--
	2017	2017	HYUNDAI IONIQ HYBRID SEL	--
11487	2004	2007	SCION XB	--
11488	2005	2006	SCION XA	--
11489	2016	2017	FORD FOCUS RS	--
11490	2018	2018	TOYO C-HR	--
11491	2007	2010	SCION XD	--
11492	2017	2017	CHEV CRUZE DIESEL	--
11493	2006	2006	NISSAN 350Z COUPE	--
	2008	2013	INFINITI G37 COUPE	--
	2014	2014	INFINITI Q60 COUPE	--

Part#	Yrs From	Yrs To	Make / Model / Style	Repl By
11496	2008	2010	HONDA ACCORD	--
	2009	2014	ACURA TL	--
	2009	2014	ACURA TSX	--
11498	2004	2010	BMW 5 SERIES SED	--
	2008	2010	BMW 530I	--
11499	2007	2008	INFINITI G35 SED, INCL X MODS	--
	2009	2013	INFINITI G37 SED, INCL X MODS	--
	2011	2012	INFINITI G25X SED	--
11501	1986	1988	ACURA LEGEND SED	--
11502	1989	1990	ACURA LEGEND SED	--
11503	1986	1989	ACURA INTEGRA HATCH	--
11504	1987	1990	ACURA LEGEND COUPE	--
11507	1985	1987	AUDI 4000S QUATTRO SED	--
11508	1978	1983	AUDI 5000 SED, INCL DIESEL & TURBO	--
11510	2008	2012	INFINITI EX35	--
	2013	2013	INFINITI EX37	--
	2014	2017	INFINITI QX50	--
11511	1989	1995	BMW 5 SERIES SED, WAG, EXCL M5	--
11512	1977	1983	BMW 320 COUPE	--
11513	2004	2005	BMW 645CI CONVERT	--
11514	1991	1993	BMW 645CI CONVERT	--
	1989	1991	BMW 300 SERIES SED & COUPE INCL XI, EXCL M3	--
11515	1978	1984	BMW 733I	--
	1985	1986	BMW 735I	--
11516	1987	1994	BMW 7 SERIES SED	--
11517	1977	1989	BMW 6 SERIES COUPE	--
11520	1985	1988	DODGE COLT HATCH	--
	1985	1985	DODGE COLT SED	--
	1985	1988	MITSU MIRA HATCH, INCL TURB	--
11521	1989	1992	DODGE COLT HATCH	--
11526	1989	1992	MITSU MIRAGE HATCH	--
11528	1989	1991	DODGE COLT SED	--
	1989	1992	EAGLE SUMMIT SED	--
	1989	1992	MITSU MIRAGE SED	--
	1989	1992	PLYMOUTH COLT SED	--
11531	1990	1991	GEO STORM, EXCL GSI	--
11532	1991	1991	GEO STORM, INCL GSI	--
	1992	1993	GEO STORM COUPE & HATCH	--
11534	1985	1988	NISSAN MAXIMA SED	--
	1987	1989	NISSAN STANZA SED	--
11536	1985	1988	NISSAN MAXIMA WAGON	--
11537	1984	1986	NISSAN 200SX COUPE	--
11539	1989	1993	NISSAN 240SX COUPE	--
	1992	1992	NISSAN 240SX CONVERT	--
11541	1990	1992	NISSAN STANZA SED	--
11542	1983	1986	NISS PULSAR COUPE, NX COUP	--
11543	1987	1990	NISSAN PULSAR COUPE	--
11544	1991	1993	NISSAN NX COUPE 1600/2000	--
11546	1986	1989	NISSAN STANZA WAGON 4WD	--
11549	1989	1993	NISSAN 240SX FASTBACK	--
11551	1982	1986	NISSAN SENTRA SED & COUPE	--
11552	1987	1990	NISSAN SENTRA SED	--
11553	1982	1986	NISSA SENTRA WAG, INCL 4WD	--
11555	2007	2016	HONDA CRV, EXCL HYBRID	--
11557	1979	1983	NISSAN 280ZX COUPE	--
11558	1984	1986	NISSAN 300ZX COUPE	--
11559	1987	1989	NISSAN 300ZX COUPE	--
11560	1982	1988	VOLKS QUANT WAG, EXCL 4WD	--
11561	1986	1988	VOLKS QUANTUM WAGON 4WD	--
11562	1990	1992	DAIHATSU ROCKY	--
11565	1981	1990	FORD ESCORT	--
	1981	1994	FORD TEMPO SED, WAG 2 & 4WD	--
	1987	1988	MERC LYNX SED & WAGON	--
	1981	1994	MERC TOPAZ	--
11566	1987	1993	FORD FESTIVA SED	--
11568	1988	1989	MERCURY TRACER	--
11570	1984	1987	PONTIAC FIERO COUPE, EXCL GT & SE	--
11574	1984	1987	HONDA CIVIC, EXCL 4WD	--
11577	1984	1985	HONDA ACCORD HATCH	--
11579	1984	1985	HONDA ACCORD SED & COUPE	--
11582	1983	1987	HONDA PRELUDE, EXCL SI	--
11583	1985	1987	HONDA PRELUDE SI	--
11584	1988	1989	HONDA PRELUDE, INCL 4-WHEEL STEER	--
11585	1984	1986	HONDA CIVIC SED	--
11586	1987	1987	HONDA CIVIC SED	--
11587	1988	1991	HONDA CIVIC SED	--
11588	1984	1987	HONDA CIVIC, EXCL CRX	--
11589	1984	1987	HONDA CIVIC CRX	--
11590	1988	1991	HONDA CIVIC, INCL CRX & SI	--

Part#	Yrs From	Yrs To	Make / Model / Style	Repl By
11592	1988	1991	HONDA CIVIC WAGON/VAN, INCL WAGON VAN 2 & 4 WD	--
11595	1991	1993	ISUZU STYLUS SED	--
11597	1986	1989	MAZDA 323 HATCH	--
11598	1990	1994	MAZDA 323 HATCH	--
11600	1986	1989	MAZDA 323 SED, EXCL 1988 GT	--
11602	1981	1985	MAZDA RX7 COUPE	--
11604	2016	2017	HONDA CIVIC SED	--
11605	1990	1990	MAZDA PROTEGE 2WD	--
11610	1989	1990	MITSU SIGMA	--
11611	1987	1990	MITSU VAN	--
11613	1974	1976	MERCEDES 230, 240D, 280, 280C, 300D, 300E SED & COUP	--
11614	1977	1985	MERCEDES 230, 240D, 280CE, 280E, 300CD, 300D SED & COUPE (123 CHASSIS)	--
11616	1974	1980	MERCEDES S CLASS SED (116 CHASSIS)	--
11617	1974	1989	MERCEDES SL COUPE & ROADSTER (129 CHASSIS)	--
11618	1980	1988	PEUGEOT 505 SED	--
11624	1987	1991	STERLING 825, 827 SED, HATCH	--
11626	1989	1994	GEO METRO HATCH, CONVERT	--
11628	1987	1988	SUZUKI SWIFT HATCH	--
11628	1987	1988	SUBARU JUSTY HATCH 2 & 4WD	--
11629	1989	1994	SUBARU JUSTY HATCH 2 & 4WD	--
11631	1985	1986	SUBARU SED 2 & 4WD, INCL LOY	--
11632	1987	1993	SUBARU SED 2 & 4WD, INCL LOY	--
11634	1985	1986	SUBARU WAGON 2&4 WD	--
11635	1987	1994	SUBARU WAG 2 & 4WD, INCL LOY	--
11639	1987	1991	SUBARU XT CPE, X-T6 2 & 4WD	--
11641	1982	1985	TOYO CELICA COUPE	--
11642	1981	1984	TOYO CRESSIDA SED	--
11643	1984	1989	TOYO VAN, WAGON INCL CARGO VAN & 4WD	--
11645	1989	1992	GEO PRIZM SED & HATCH	--
11645	1987	1992	TOYO COROLLA SED	--
11645	1988	1992	TOYO COROLLA 4WD	--
11645	1987	1988	TOYO COROLLA 2WD	--
11646	1987	1991	TOYO CAMRY SED & WAGON	--
11646	1986	1989	TOYO CELICA COUPE	--
11646	1987	1988	TOYO CRESSIDA SED	--
11646	1986	1989	TOYO SUPRA HATCH	--
11647	1986	1989	TOYO CELICA HATCH	--
11649	1979	1983	TOYO COROLLA SED & WAGON	--
11649	1979	1986	TOYO CORONA SED & WAGON	--
11649	1987	1984	TOYO STARLET HATCH	--
11649	1983	1986	TOYO TERCEL HATCH & WAGON	--
11651	1982	1985	TOYO CELICA HATCH	--
11651	1982	1985	TOYO SUPRA HATCH	--
11652	1968	1979	VOLKS BEET/SPRBEET COUPE	--
11653	1975	1984	VOLKS RABBIT, INCL CONVERT	--
11653	1975	1981	VOLKS SCIROCCO	--
11654	1985	1990	VOLKS GOLF & GTI, EXCL WOLFSBURG ED.	--
11655	1973	1973	VOLKS BUS/TRUCK, TYPE 2	--
11656	1980	1992	VOLKS VANAGON, EXCL SYNCRO	--
11657	1987	1992	VOLKS VANAGON SYNCRO 4WD	--
11658	1980	1984	VOLKS JETTA SED, EXCL WOLFSBURG ED.	--
11659	1985	1990	VOLKS JETTA SED, EXCL WOLFSBURG ED.	--
11660	1982	1988	VOLKS SCIROCCO	--
11661	1985	1993	VOLKS CABRIOLET CONVERT	--
11661	1985	1993	VOLKS RABBIT, INCL CONVERT	--
11662	1987	1993	VOLKS FOX SED, WAG, COUPE	--
11664	1986	1993	VOLVO 140, 160, 240 SERIES SED & WAGON	--
11666	1984	1987	MERCEDES 190 CLASS SED (201 CHASSIS)	--
11667	1994	1999	DODGE NEON SED & COUPE	11038
11667	1994	1999	PLYMOUTH NEON SED & COUPE	
11668	1994	1997	FORD ASPIRE 3 & 5DR HATCH	--
11679	2005	2009	KIA SPECTRA SED	--
11680	2005	2006	MERCEDES C CLASS WAGON (040 CHASSIS)	--
11681	2013	2017	HONDA ACCORD	--
11699	2007	2010	HONDA ELEMENT SC	--
11700	2003	2011	HONDA ELEMENT, EXCL SC	--
11701	2003	2009	MERCEDES E CLASS SED (211 CHASSIS)	--
11701	2004	2009	MERCEDES E CLASS WAGON	--

Part#	Yrs From	Yrs To	Make / Model / Style	Repl By
11702	1987	1990	BMW 300 SERIES CONVERT	--
11702	1987	1988	BMW 300 SED, COUPE, EXCL M3	--
11703	1990	1996	NISSAN 300ZX COUPE	--
11704	1989	1992	FORD PROBE COUPE, EXCL GT	--
11705	1984	1996	CHEV/GMC CORVETTE COUPE & CONVERT, INCL ZR-1	--
11706	1990	1992	INFINITI M30 SED & CONVERT	--
11707	1991	1996	INFINITI G20 SED	--
11708	1992	1995	MAZDA MX-3 COUPE	--
11710	1991	1996	DODGE STEALTH COUPE	--
11710	1991	1999	MITSU 3000GT COUPE	--
11711	1981	1991	MERCEDES S CLASS SED & COUPE (126 CHASSIS)	--
11712	1977	1991	PORSCHE 924, 944 COUPE	--
11713	1991	1995	TOYO MR2 COUPE, VERTIC REC	--
11714	1991	1992	VOLKS GOLF & GTI, INCL 1990 WOLFSBURG ED.	--
11715	1991	1992	VOLKS JETTA SED, INCL 1990 WOLFSBURG ED.	--
11716	1990	1994	VOLKS CORRADO HATCH	--
11717	1990	1994	VOLKS PASSAT SED	--
11718	1990	1994	VOLKS PASSAT WAGON	--
11720	1993	1997	FORD PROBE COUPE, EXCL GT	--
11721	1988	1993	MERCEDES 190 CLASS SED (201 CHASSIS)	--
11722	1985	1990	VOLKS JETTA SED, EXCL WOLFSBURG ED.	--
11724	1993	1997	HONDA CIVIC DEL SOL	--
11725	1990	1991	HONDA PRELUDE	--
11726	1986	1989	HONDA ACCORD SED & COUPE	--
11727	1993	1997	INFINITI J30 SED	--
11728	1993	1995	MITSU DIAMANTE WAGON	--
11729	1990	1997	MAZDA MIATA MX5 CONVERT, HORIZONTAL REC TUBE	--
11730	1995	1998	SAAB 900 CONVERT	--
11730	1994	1998	SAAB 900 HATCH	--
11731	1995	1998	NISSAN 240SX COUPE	--
11732	1995	1995	VOLKS CABRIO COVERT (GOLF)	--
11733	1975	1987	JAGUAR XJ6, XJ12 SED	--
11733	1975	1993	JAGUAR XJS COUPE & CONVER	--
11734	1988	1994	JAGUAR XJ6, XJ12 SED	--
11735	1995	1997	VOLKS PASSAT SED	--
11736	1995	1997	VOLKS PASSAT WAGON	--
11742	1990	2002	MERCEDES SL COUPE & ROADSTER (129 CHASSIS)	--
11744	1996	2002	MERCEDES E CLASS SED (210 CHASSIS)	--
11745	1995	1998	VOLKS GOLF GTI VR6 HATCH OLY	--
11746	1990	1997	MAZDA MIATA MX5 CONVERT, VERTICAL REC TUBE	--
11747	1995	2001	BMW 7 SERIES SED	--
11748	1996	2002	BMW Z3, EXCL M VERSIONS	--
11749	1998	2005	MAZDA MIATA MX5 CONVERT, HORIZONTAL REC TUBE	--
11750	1997	2000	JAGUAR XK8, XKR COUP & CNVRT	--
11751	1998	2004	MERCEDES SLK COUPE & ROADSTER (170 CHASSIS)	--
11754	1999	2002	SAAB 9-3 CONVERT, 3 & 5DR	--
11755	1998	2005	MAZDA MIATA MX5 CONVERT, VERTICAL REC TUBE	--
11756	2005	2010	BMW 335I & 335XI SED	--
11758	1975	1979	CHEV/GMC CORVETTE	--
11760	1980	1982	CHEV/GMC CORVETTE	--
11762	2001	2005	LEXUS IS300	--
11764	2000	2002	DAEWOO NUBRIA SED	--
11765	2000	2005	AUDI TT QUATTRO ONLY COUPE & CONVERT	--
11767	1993	1994	DODGE COLT SED & COUPE	--
11767	1993	1997	EAGLE SUMMIT SED & COUPE	--
11767	1993	2003	MITSU MIRAGE COUPE	--
11767	1993	2001	MITSU MIRAGE SED	--
11767	1993	1994	PLYMOUTH COLT SED & COUPE	--
11768	2002	2006	HONDA CRV	--
11771	2006	2006	BMW 325XI WAGON	--
11771	2007	2011	BMW 328I WAGON	--
11771	2007	2011	BMW 328XI WAGON	--
11772	1996	1999	INFINITI I30 SED	--
11772	1997	1999	NISSAN MAXIMA SED	--
11773	2001	2003	ACURA MDX	--
11773	2001	2003	HONDA PILOT	--
11775	2009	2010	AUDI TT QUATTRO	--
11801	1990	1996	INFINITI Q45 SED	--
11804	1988	1991	MAZDA 929 SED	--

Part#	Yrs From	Yrs To	Make / Model / Style	Repl By
11805	1979	1986	MERCEDES 300TD & TE WAGON (123 CHASSIS)	--
11806	1987	1996	MERCEDES 300TD, TE, & E320 WAGON (124 CHASSIS)	--
11807	1981	1986	SAAB 900 SED & WAGON	--
11808	1986	1994	SAAB 900 CONVERT	--
11808	1987	1993	SAAB 900 SED & HATCH	--
11809	1986	1988	SAAB 9000 HATCH	--
11810	1989	1992	SAAB 9000 HATCH	--
11811	1989	1995	SAAB 9000 SED CD	--
11811	1993	1998	SAAB 9000 HATCH CS	--
11812	1981	1990	TOYO LANDCRUISE	--
11814	1998	1999	MERCEDES CL COUPE	--
11814	1992	1999	MERCEDES S CLASS SED (140 CHASSIS)	--
11814	1992	1997	MERCEDES S CLASS COUPE, EXCL SL COU RDSTR 140 CHASS	--
11815	1994	2000	MERCEDES C CLASS SED (202 CHASSIS)	--
11815	1998	2003	MERCEDES CLK CABRIOLET 350 (208 CHASSIS)	--
11815	1998	2002	MERCEDES CLK COUPE (208 CHASSIS)	--
11816	1986	1995	MERCEDES E CLASS SED & COUPE (124 CHASSIS)	--
11818	1995	2003	JAGUAR XJ6, XJ8, XJ8L, XJ12, XJR	--
11820	2004	2005	MERCEDES E320 WAG 211 CHASS	--
11820	2004	2006	MERCEDES E500 WAG 211 CHASS	--
11821	1999	2008	SAAB 9-5 SED & WAGON	--
11822	2000	2004	VOLVO S40 SED	--
11822	2000	2004	VOLVO V40 WAGON	--
11823	2000	2006	MERCEDES S CLASS SED (220 CHASSIS)	--
11824	2001	2007	MERCEDES C CLASS SED (202 CHASSIS)	--
11824	2001	2004	MERCEDES C CLASS WAGON (203 CHASSIS)	--
11828	2007	2011	MERCEDES S550 INCL 4MATIC	--
11829	2008	2009	VOLVO C30 3 DOOR LIFTBACK	--
11830	1998	2003	MERCEDES E CLASS WAGON (210 CHASSIS)	--
11831	1999	2009	SAAB 9-5 SED & WAGON	--
11900	2016	2018	CHEV CAMERO	--
11900	2014	2017	CAD CTS BASE / LUXURY	--
11900	2014	2017	CAD CTS PERFORMANCE / PREM	--
11900	2016	2017	CAD CTS V / VSPORT / PREMIU	--
11901	2016	2017	CAD CTS V / VSPORT / PREM	11900
12002	2006	2013	SUZUKI GRAND VITARA	--
12003	1996	1999	MAZDA MPV VAN	--
12004	2007	2009	ACURA RDX	--
12005	1978	1981	BUICK CENTURY SED & WAGON	--
12005	1978	1987	BUICK REGAL RWD	--
12005	1977	1988	CHEV MONTE CARLO	--
12005	1977	1988	CHEV EL CAMINO	--
12005	1978	1983	OLDS CUTLASS CIERA CRUISE RWD WAGON	--
12005	1978	1988	OLDS CUTLASS SUPREME FWD SED & COUPE	--
12006	1998	2004	DODGE INTREPID	--
12008	1985	1996	OLDS CUTLASS CIERA FWD	--
12008	1985	1991	PONTIAC 6000	--
12009	1977	1984	BUICK ELECTRA/PARK AVE RWD	--
12009	1992	1985	BUICK LESABRE	--
12009	1977	1996	BUICK ROADMASTER	--
12009	1992	1996	CHEV CAPRICE SED	--
12009	1977	1985	OLDS DELTA 88 & 88	--
12009	1980	1984	OLDS 98 & 98 REGENCY	--
12009	1983	1986	PONTIAC PARISIENNE	--
12010	2010	2016	LINC MKT EXCL ECOBOOST	--
12011	1983	2004	CHEV/GMC S10/S15, SONOMA	--
12011	1996	2000	ISUZU HOMBRE	--
12012	1983	2011	FORD RANGER	--
12012	1994	2010	MAZDA B2300, B3000, B4000	--
12013	2003	2008	TOYO MATRIX XR & XRS	--
12021	1994	1997	HONDA PASSPORT	--
12021	1991	1997	ISUZU RODEO	--
12021	1994	1997	HONDA PASSPORT	--
12022	2010	2011	BUICK LUCERNE	--

Part#	Yrs From	Yrs To	Make / Model / Style	Repl By
12025	1990	1993	CHRYSLER IMPERIAL	--
	1989	1994	CHRYSLER LEBARON	
	1988	1993	CHRYSLER NEW YORKER, INCL 5TH AVE. & SALON	
	1988	1993	DODGE DYNASTY	
	1989	1995	DODGE SPIRIT	
	1989	1995	PLYMOUTH ACCLAIM	
12027	1997	2005	CHEV/GMC MALIBU CLASSIC	--
	1997	2000	OLDS CUTLASS	
12028	2000	2007	CHEV/GMC MTE CARLO, EXCL SS	--
12030	2010	2015	HYUNDAI TUCSON	--
	2011	2015	KIA SPORTAGE	
12031	1999	2017	HONDA ODYSSEY	--
12032	1998	2001	CHRYSLER CONCORDE	--
12034	1999	2003	CHRYSLER 300M, EXCL SPECIAL	--
12035	1998	2001	CHRYSLER LHS	--
12036	2007	2014	FORD EDGE	--
	2007	2015	LINC MKX	
12037	1983	1994	CHEV/GMC S10 BLAZE/ S15 JIM	--
	1991	1994	OLDS BRAVADA	
12038	1998	2008	SUBARU FORESTER	--
12040	1999	2004	OLDS ALERO	--
	1999	2005	PONTIAC GRAND AM	
12041	1977	1990	BUICK ESTATE/LESABRE WAGON	--
	1991	1996	BUICK RDMSTR/ESTATE WAGN	
	1977	1996	CHEV CAPRICE WAGON	
	1977	1992	OLDS CUSTOM CRUISE	
	1983	1986	PONTIAC PARISIENNE WAGON	
12044	2000	2005	BUICK LESABRE	--
	2006	2009	BUICK LUCERNE	
	2000	2003	OLDS AURORA	
	2000	2005	PONTIAC BONNEVILLE, EXCL SLE	
12045	1985	2005	CHEV/GMC ASTRO/SAFARI VAN, EXCL 16 SPARE	--
12047	2009	2013	SUBARU FORESTER	--
12048	2011	2017	MITSU OUTLANDER SPORT	--
	2011	2015	MITSU OUTLANDER RVR	
12049	1991	1996	BUICK ELECTRA/PARK AVENUE	--
	1991	1997	OLDS 98 REGENGY & TOURING	
12050	2011	2014	SUBARU TRIBECA	--
12051	2008	2012	CHEV/GMC MALIBU, EXCL HYBRID	--
	2007	2009	SATURN AURA	
12052	1994	1996	CAD DEVILLE	--
12053	1989	1997	FORD THUNDERBIRD, EXCL SC	--
	1993	1998	LINC MARK VIII	
	1989	1997	MERCURY COUGAR	
12054	1992	1994	CAD ELDORADO	--
	1992	1997	CAD SEVILLE	
12055	1997	1999	CAD DEVILLE	--
12056	2006	2010	MERCEDES R350	--
	2006	2008	MERCEDES R500	
12057	2011	2017	JEEP COMPASS	--
	2011	2017	JEEP PATRIOT	
12058	2000	2005	CAD DEVILLE FWD	--
	2006	2011	CAD DTS	
12060	2005	2012	FORD ESCAPE	--
	2005	2011	MAZDA TRIBUTE	
	2005	2011	MERCURY MARINER	
12061	2011	2016	NISSAN QUEST	--
12064	2011	2015	DODGE CHARGER	--
	2011	2015	CHRYSLER 300C	
	2011	2015	DODGE CHALLENGER	
	2012	2015	CHRYSLER 300S	
12065	2004	2017	TOYO SIENNA	--
12066	2008	2009	VOLVO V70 WAGON	--
	2009	2016	VOLVO XC70	
	2011	2016	VOLVO S60 SED	
	2015	2016	VOLVO V60	
12068	1995	2002	CAD ELDORADO	--
12069	1988	1996	BUICK REGAL	--
	1990	1994	CHEV LUMINA, EXCL Z34	
	1988	1997	OLDS CUTLASS SUPREME	
	1988	1996	PONTIAC GRAND PRIX, EXCL SE	
12070	2010	2016	CAD SRX	--
12073	1992	1998	BUICK SKYLARK	--
	1992	2000	OLDS ACHIEVA	
	1992	1998	PONTIAC GRAND AM	
12074	2010	2012	ACURA RDX	--
12076	2010	2013	FORD TRANSIT CONNECT	--
12083	2013	2018	ACURA RDX	--
12086	2009	2016	HYUNDAI GENESIS SED	--
12088	2009	2016	LINC MKS	--
12089	1986	1997	FORD AEROSTAR	--

Part#	Yrs From	Yrs To	Make / Model / Style	Repl By
12091	2017	2018	FORD FUSION ENERGI PLAT	--
	2014	2018	FORD FUSION ENERGI SE LUX	
	2013	2018	FORD FUSION ENERGI TITANIUM	
	2017	2018	FORD FUSION PLAT / PLAT HY	
	2013	2018	FORD FUSION S	
	2014	2018	FORD FUSION S HYBRID	
	2013	2018	FORD FUSION SE / SE HYBRID	
	2013	2018	FORD FUSION TITAN / TITAN HY	
	2014	2017	LINC MKZ	
	2013	2013	LINC MKZ EXCL 3.0L AWD	
12092	2013	2017	FORD C-MAX	--
12093	2007	2012	MAZDA CX-7	--
12094	1996	2007	CHRY TOWN & CTRY EXCL ST & GO	--
	1996	2007	DODGE CARAVAN/GRAND CARAVAN EXCL STOW & GO	
	1996	2004	PLYMOUTH VOYAGER/GRAND VOYAGER EXCL STOW & GO	
12095	2008	2009	SATURN VUE, INCL REDLINE	--
	2012	2015	CHEV CAPTIVA	
12096	2015	2018	LINC MKC	--
12097	2009	2017	VOLKS TIGUAN	--
12098	1990	1993	CHEV/GMC LUMINA APV VAN	--
	1990	1996	OLDS SILHOUETTE	
	1990	1993	PONTIAC TRANS SPORT	
12100	2014	2018	SUBARU FORESTER	--
12101	1993	1997	CHRYSLER CONCORDE	--
	1994	1997	CHRYSLER LHS	
	1994	1996	CHRYSLER NEW YORKER	
	1993	1997	DODGE INTREPID	
	1993	1997	EAGLE VISION	
12102	1999	2002	MERCURY VILLAGER	--
	1999	2002	NISSAN QUEST	
12103	1995	1999	BUICK RIVIERA	--
	1995	1999	OLDS AURORA	
12105	1995	1998	MERCURY VILLAGER	--
	1995	1998	NISSAN QUEST	
12106	2004	2009	CAD SRX	--
12107	2013	2018	TOYO AVALON	--
	2012	2017	TOYO CAMRY	
12108	2006	2012	TOYO RAV4 BASE	--
	2016	2017	TOYO RAV4 HYBRID LTD & XLE	
	2013	2017	TOYO RAV4 LE	
	2006	2017	TOYO RAV4 LTD	
	2017	2017	TOYO RAV4 PLATINUM	
	2016	2016	TOYO RAV4 SE	
	2006	2012	TOYO RAV4 SPORT	
	2013	2017	TOYO RAV4 XLE	
12110	2004	2010	TOYO SOLARA	--
12111	2013	2018	FORD ESCAPE	--
12112	2007	2015	MAZDA CX-9	--
12113	2013	2018	HYUN SANTA FE SPRT	--
	2013	2018	HYUN SANTA FE SPRT 2.0T	
	2017	2018	HYUN SANTA FE SPRT 2.0T ULTI	
	2014	2015	KIA SORENTO	
12114	2012	2017	LEXUS LS460	--
12115	2010	2016	BUICK LACROSSE	--
	2011	2017	BUICK REGAL	
	2013	2017	CAD XTS	
	2014	2018	CHEV IMPALA	
	2013	2015	CHEV MALIBU	
	2016	2016	CHEV MALIBU LTD	
12116	2014	2016	KIA RONDO	--
12117	1994	1996	CHEV/GMC LUMINA APV VAN	--
	1994	1996	PONTIAC TRANS SPORT	
12118	2014	2017	KIA CADENZA	--
12120	2014	2017	ACURA RLX	--
12121	1994	2003	FORD WINDSTAR	--
12122	2008	2009	NISSAN ROGUE	--
	2010	2011	NISSAN ROGUE S	
	2010	2010	NISSAN ROGUE SL	
	2011	2011	NISSAN ROGUE SV	
	2012	2017	NISSAN ROGUE	
	2014	2015	NISSAN ROGUE SELECT	
12123	2014	2017	FORD TRANSIT CONNECT	--
12125	1995	2000	CHEV/GMC LUMINA	--
	1995	1999	CHEV/GMC MONTE CARLO	
12126	2004	2010	KIA SPORTAGE	--
12127	1996	1999	OLDS 88 & DELTA 88	--
	1996	1999	PONTIAC BONNEVILLE, EXCL SSE & SSEI	
12128	1992	1999	PONTIAC BONNEVILLE SSE, SSEI	--

Part#	Yrs From	Yrs To	Make / Model / Style	Repl By
12130	1979	2011	FORD LTD/CROWN VICTORIA	--
	1979	1991	FORD LTD/COUNTRY SQUIRE	
	1980	1983	LINC MARK VI	
	1980	2011	LINC TOWN CAR	
	1979	1991	MERCURY COLONY PARK WAG	
	1983	2009	MERCURY GRND MARQUIS SED	
	1979	1982	MERCURY GRND MARQUIS WAG	
	2003	2004	MERCURY MARAUDER	
12134	2009	2017	DODGE JOURNEY	--
12136	2014	2018	SUBARU OUTBACK	--
12137	1984	2001	JEEP CHEROKEE	--
12138	2015	2015	JEEP RENEGADE EXCL 4WD	--
12139	2015	2015	LEXUS NX 200T / NX 300H	--
12140	2015	2017	FORD EDGE	--
12141	1988	1995	CHRYSTLER TOWN & COUNTRY	--
	1988	1995	DODGE CARAVAN	
	1984	1995	PLYMOUTH VOYAGER	
12142	2015	2017	JEEP RENEGADE	--
12143	2015	2016	LEXUS NX 300H / NX 200T	--
12148	2015	2018	AUDI Q3 / Q3 QUATTRO	--
12152	2016	2018	CHEV MALIBU	--
12156	2016	2017	MAZDA CX-9	--
12157	1997	2005	BUICK PARK AVENUE	--
12158	2017	2018	KIA SPORTAGE	--
12159	2017	2018	CHRY PACIFICA LTD	--
	2017	2018	CHRY PACIFICA LX	
	2017	2018	CHRY PACIFICA TOURING	
	2017	2018	CHRY PACIFICA TOURING L	
	2017	2018	CHRY PACIFICA TOURING L PLUS	
12160	2016	2018	CAD CT6 BASE / LUX	--
	2016	2018	CAD CT6 PLAT / PREM LUX	
12163	2016	2018	MERCEDES-BENZ CLA250	--
12164	2017	2018	FORD FUSION SPORT	--
	2017	2017	LINC MKZ BLK LABEL AWD, 3.0L	
	2017	2017	LINC MKZ RESERVE AWD, 3.0L	
	2017	2017	LINC MKZ SELECT AWD, 3.0L	
12165	2012	2012	HYUNDAI GENESIS 5.0	--
	2015	2016	HYUNDAI GENESIS 5.0	
	2017	2018	GENESIS G80	
12166	2017	2018	BUICK LACROSSE	--
12167	2017	2018	LINC CONTINENTAL	--
12169	2017	2018	HONDA CR-V	--
12170	2013	2017	MAZDA CX-5	--
12171	2017	2018	KIA NIRO	--
12172	2017	2017	LEXUS NX200T / NX300H	--
12174	2017	2017	JEEP COMPASS LTD / SPORT / TRAILHAWK / LATITUDE 11TH DIGIT OF VIN IS 'T'	--
	2018	2018	JEEP COMPASS LTD / LATITUDE	
	2018	2018	JEEP COMPASS TRAILHAWK	
	2018	2018	JEEP COMPASS SPORT	
12175	2018	2018	HONDA ODYSSEY	--
12176	2018	2018	TOYO CAM HYBRI LE, SE, XLE, L	--
	2018	2018	TOYO CAMRY LE, SE, XLE, XSE	
12177	2018	2018	VOLKS TIGUAN SE / SEL PREM	--
	2018	2018	VOLKS TIGUAN SEL / S	
12181	1987	1989	DODGE RAIDER	--
	1989	1994	ISUZU AMIGO, EXCL 3.2L	
	1988	1991	ISUZU TROOPER & TROOPER II	
	1983	2000	MITSU MONTERO, EXCL SPORT	
	1991	1997	TOYO LANDCRUISE	
12186	2001	2006	CHRYSLER SEBRING SED	--
12187	2004	2007	FORD FREESTAR	--
	2004	2007	MERCURY MONTEREY VAN	
12189	2008	2010	DODGE AVENGER	--
	2007	2010	CHRYSLER SEBRING 4DR	
12190	2008	2010	CHRY SEBRING CONVERT, TOUR	--
12199	1997	2008	PONTIAC GRAND PRIX	--
12207	1974	1993	VOLVO 140, 160, 240, 260 SERIES SED & WAGON	--
12209	1984	1993	VOLVO 740 SED & WAGON	--
	1983	1996	VOLVO 760 SED & WAGON	
	1988	1990	VOLVO 780 COUPE	
	1991	1995	VOLVO 940 SED & WAGON	
	1991	1994	VOLVO 960 SED & WAGON	
12211	1993	1997	VOLVO 850 SED & WAGON	--
	1998	2004	VOLVO C70 COUPE & S70 SED	
	1998	2000	VOLVO V70	
	1998	1998	VOLVO V70R TURBO AWD WAG	
12213	1995	1997	VOLVO 960 SED & WAGON	--
	1998	1998	VOLVO S90 SED & V90 WAGON	
12217	1993	2003	VOLKS EUROVAN/TRANSPRTER	--
12220	1997	2001	INFINITI Q45 SED	--

Part#	Yrs From	Yrs To	Make / Model / Style	Repl By
12221	2003	2010	PONTIAC VIBE GT	--
	2003	2013	TOYO MATRIX	--
12224	2000	2001	INFINITI I30 SED	--
	2002	2004	INFINITI I35 SED	--
	2000	2003	NISSAN MAXIMA SED	--
12225	1997	2004	BUICK REGAL	--
	1997	2008	PONTIAC GRAND PRIX GT & GTP SED & COUPE	--
12228	2009	2010	PONTIAC VIBE	--
	2009	2013	TOYO MATRIX	--
12230	1995	2000	LEXUS LS400	--
12231	2001	2006	LEXUS LS430	--
12232	1986	2007	FORD TAURUS	--
	1986	1994	LINC CONTENTL, EXCL DUAL EXH	--
	1986	2007	MERCURY SABLE	--
12233	1992	1999	BUICK LESABRE	--
	1992	1995	PONTIAC BONNEVILLE, EXCL SSE & SSEI	--
12234	2003	2008	PONTIAC VIBE	--
12237	1995	2004	KIA SPORTAGE	--
12239	2005	2009	BUICK ALLURE (CANADA)	--
	1997	2006	BUICK CENTURY	--
	2005	2009	BUICK LACROSSE	--
	1998	2002	OLDS INTRIGUE	--
12240	2009	2010	DODGE CHALLENGER	--
	2006	2010	DODGE CHARGER	--
	2004	2008	DODGE MAGNUM	--
	2005	2010	CHRYSLER 300	--
	2004	2009	CHRY 300C, TOURING & LTD	--
12241	2016	2017	HYUNDAI TUCSON ECO	--
	2016	2017	HYUNDAI TUCSON LTD	--
	2016	2017	HYUNDAI TUCSON SPORT	--
	2016	2017	HYUNDAI TUCSON SE	--
12242	2005	2008	FORD 500	--
	2008	2009	FORD TAURUS	--
	2005	2008	FORD FREESTYLE	--
	2005	2008	MERCURY MONTEGO	--
	2008	2009	MERCURY SABLE	--
12243	1995	2002	LINC CONTINENTL W/DUAL EXH	--
12244	2005	2007	BUICK TERRAZZA	--
	2005	2008	CHEV UPLANDER	--
	2009	2009	CHEV UPLANDER, CANAD ONLY	--
	1997	2007	CHEV VENTURE	--
	1997	2005	OLDS SILHOUETTE	--
	2005	2007	PONTIAC MONTANA SV6	--
	2008	2009	PONT MONTANA SV6, CAN OLY	--
	1997	2005	PONTIAC TRANS SPORT	--
	2005	2007	SATURN RELAY	--
12245	2008	2012	JEEP LIBERTY	--
12246	2004	2006	PONTIAC GTO	--
12252	2000	2013	CHEV IMPALA	--
	2014	2016	CHEV IMPALA LTD	--
12253	2000	2006	LINC LS	--
12255	2007	2010	JEEP COMPASS	--
	2007	2009	JEEP PATRIOT	--
12259	2007	2009	KIA AMANTI	--
12262	2004	2006	CHRYSLER PACIFICA	--
12264	2008	2017	DODGE GRAND CARAVAN	--
			W/ STOW 'N GO	--
	2008	2016	CHRYSLER TOWN & COUNTRY	--
	2012	2016	RAM CARGO VAN	--
	2009	2014	VOLKS ROUTAN	--
12265	1998	2004	CAD SEVILLE	--
12270	1990	2004	SUBARU LEGACY	--
	1995	2004	SUBARU OUTBACK SED & WAG	--
12272	2004	2007	CHEV/GMC MALIBU SED	--
12280	2004	2007	CHEV/GMC MLBU MAXX, EXCL SS	--
12284	2005	2009	SUBARU LEGACY SED & WAGON	--
	2005	2009	SUBARU OUTBACK SED & WAG	--
12285	1999	2006	VOLVO S80 SED	--
12287	2007	2014	VOLVO S80 SED	--
12288	2000	2006	MAZDA MPV VAN	--
12289	2004	2007	CHRYSLER TOWN & COUNTRY	--
	2004	2007	DODGE GRAND CARAVAN	--
12290	2015	2017	SUBARU LEGACY	--
	2010	2013	SUBARU OUTBACK SED & WAG	--
	2010	2011	SUBARU OUTBACK SPORT (CANADIAN BUILT)	--
12291	2005	2017	CHEV/GMC EQUINOX	--
	2010	2017	GMC TERRAIN	--
	2006	2009	PONTIAC TORRENT	--
	2001	2007	SATURN VUE	--
	2004	2007	SATURN VUE REDLINE	--

Part#	Yrs From	Yrs To	Make / Model / Style	Repl By
12292	2008	2009	FORD TAURUS X	--
12293	2003	2006	NISSAN OUTLANDER	--
12296	2010	2017	FORD TAURUS	--
12298	2010	2014	SUBARU LEGACY SED	--
12303	1987	1993	MAZDA B2300, B3000, B4000 PICKUPS 4WD ONLY	--
12304	1991	1997	TOYO PREVIA VAN	--
12312	1998	1998	NISSAN FRONTIER	13064
12314	2000	2004	JAGUAR S TYPE	--
12318	2001	2009	VOLVO S60 SED	--
	2001	2006	VOLVO V70	--
	2001	2007	VOLVO XC70 AWD WAGON	--
12333	2005	2009	PONTIAC G6 SED	--
12336	2005	2007	BUICK TERRAZZA	--
	2005	2008	CHEV UPLANDER, 121 WB ONLY	--
	2005	2007	PONTIAC MONTANA SV6, 121 WHEEL BASE ONLY	--
	2005	2007	SATURN RELAY	--
12339	1997	2003	LEXUS ES 300 SED	--
	2002	2006	LEXUS ES 330 SED	--
	1994	2004	TOYO AVALON	--
	1997	2006	TOYO CAMRY SED	--
	1999	2003	TOYO SOLARA	--
12341	2009	2015	TOYO VENZA	--
12343	2007	2012	LEXUS ES350	--
	2007	2011	TOYO CAMRY, EXCL SE	--
12362	1996	2007	CHRYSLER TOWN & COUNTRY W/STOW & GO	--
	1996	2007	DODGE CARAVAN W/ STOW & GO	--
	1996	2004	PLYMOUTH VOYAGER	--
12490	2008	2015	SCION XB	--
12923	--	--	MULTI-FIT, SEE PAGE 17	--
13000	2010	2016	LINC MKT ECOBOOST	--
13001	2006	2013	SUZUKI GRAND VITARA	--
13002	2010	2016	CAD SRX	--
13005	2009	2010	KIA BORREGO	--
13007	2009	2010	HUMMER H3T	--
13008	2001	2007	CHEV/GMC SILVERADO/SIERRA 2500HD/3500 CLSC BOD 8' BED	--
13010	2010	2015	MERCEDES G550	--
13011	1984	1990	FORD BRONCO II	--
13013	1995	2004	TOYO TACOMA	--
13014	1999	2016	FORD F-250 & F-350 SD	--
13015	1998	2004	DODGE FULL SIZE VAN, EXCL STEP BUMPER	--
13016	1978	1996	CHEV/GMC FULL SIZE VAN (G-SERIES)	--
13017	1973	1991	CHEV/GMC SUBURBAN	--
13018	1998	2005	MERCEDES M-SERIES SUV	--
13019	1983	2011	FORD RANGER	--
	1994	2010	MAZDA B2300, B3000, B4000	--
13020	1995	2004	CHEV/GMC S10 / S15	--
	1999	2001	CHEVROLET BLAZE / TRLBLAZ	--
	1999	2000	GMC JIMMY ENVOY	--
	1995	2002	OLDS BRAVADA	--
13021	1983	2004	CHEV/GMC S10/S15, SONOMA	--
	1996	2000	ISUZU HOMBRE	--
13024	1987	1991	TOYO 4 RUNNER	--
13028	1962	1987	CHEV/GMC FULLSIZE PICKUPS, EXCL 10 DROP BUMPER	--
	1988	1991	CHEV/GMC FULLSIZE, CREW OLY	--
	1973	2006	CHEV/GMC CAB & CHAS, 34 FRM	--
	1973	1973	FORD F250 CREW CAB	--
	1973	2006	FORD CAB & CHASSIS, 34 FRM	--
13029	1992	2000	CHEV/GMC SUBURBAN, YUKON, & TAHOE	--
	1992	2000	CAD ESCALADE	--
	1992	1994	CHEV/GMC BLAZE, FULL SIZE	--
13032	1986	1997	FORD AEROSTAR	--
13033	1991	2001	FORD EXPLORER, INCL SPORT	--
	1991	1994	MAZDA NAVAJA	--
	1996	2001	MERCURY MOUNTAINEER	--
13035	1985	2005	CHEV/GMC ASTRO/SAFARI VAN, EXCL 16 SPARE	--
13037	1991	1995	CHRYSLER TOWN & COUNTRY	--
	1991	1995	DODGE CARAVAN	--
	1991	1995	PLYMOUTH VOYAGER	--
13038	1997	2003	FORD F-150 & F-250LD	--

Part#	Yrs From	Yrs To	Make / Model / Style	Repl By
13040	1996	2014	CHEV EXPSS 1500 EXCL CUTAW	--
	1996	2017	CHEV EXPSS 2500 EXCL CUTAW	--
	1996	2017	CHEV EXPSS 3500 EXCL CUTAW	--
	1996	2014	GMC SAV 1500 EXCL CUTAWAY	--
	1996	2017	GMC SAV 2500 EXCL CUTAWAY	--
	1996	2017	GMC SAV 3500 EXCL CUTAWAY	--
13041	1978	1997	DODGE FULL SIZE VAN, EXCL STEP BUMPER	--
13042	1988	1998	CHEV/GMC 1500 PICKUP	--
	1988	2000	CHEV/GMC 2500/3500 PICKUP	--
13043	2010	2017	LEXUS GX460	--
13044	2001	2007	JEEP LIBERTY	--
13045	1993	1998	TOYO T100 PICKUPS 4WD	--
13046	2006	2010	SUBARU B9 TRIBECA	--
13048	1993	1998	JEEP GRAND CHEROKEE	--
13049	1997	2002	FORD EXPED.	--
	1998	2002	LINC NAVIGATOR	--
13050	2004	2009	CAD SRX	--
13051	1999	2004	JEEP GRAND CHEROKEE	--
13052	2008	2015	LAND ROVER LR2	--
13053	1975	2006	FORD ECONOLINE VAN E-SER	--
13055	2000	2014	FORD ECONOLINE VAN E-SER	--
13056	1998	2003	DODGE DURANGO	--
13057	2009	2012	AUDI Q5 QUATTRO	13136
13061	2011	2014	CHEV/GMC SILVERADO/SIERRA 2500HD/3500 LONG BOX	--
13062	2011	2014	CHEV/GMC SILVERADO/SIERRA 2500HD/3500 SHORT BOX	--
13063	2011	2014	CHEV/GMC SILVERADO/SIERRA 2500HD/3500 LG & SHORT BOX	--
13064	1998	1999	NISSAN FRONTIER	--
13065	2011	2011	JEEP GRAND CHEROKEE	--
	2012	2017	JEEP GRAND CHEROKEE LAREDO	--
	2012	2013	JEEP GRAND CHEROKEE LTD	--
	2012	2013	JEEP GRAND CHEROK OVRLND	--
	2012	2013	JEEP GRD CHEROK OVRLND SUM	--
	2014	2017	JEEP GRAND CHEROKEE LTD, EXCL DIESEL	--
	2014	2017	JEEP GRAND CHEROKEE OVERLAND, EXCL DIESEL	--
	2014	2017	JEEP GRAND CHEROKEE SUMMIT, EXCL DIESEL	--
	2016	2016	JEEP GRND CHEROK 75TH ANNY	--
	2017	2017	JEEP GRAND CHEROKEE TRAILHAWK, EXCL DIESEL	--
13066	2010	2015	HYUNDAI TUCSON	--
	2011	2015	KIA SPORTAGE	--
13067	2007	2014	FORD EDGE	--
	2007	2015	LINC MKX	--
13068	1999	2017	HONDA ODYSSEY	--
13069	2011	2014	SUBARU TRIBECA	--
13071	2011	2014	CHEV/GMC SILVERADO/SIERRA 2500HD/3500 LG & SHORT BOX	--
13072	2007	2009	CHRYSLER ASPEN	--
	2004	2009	DODGE DURANGO	--
13073	2011	2013	KIA SORENTO SX	--
13076	2010	2013	FORD TRANSIT CONNECT	--
13077	2007	2017	BMW X5	--
	2014	2017	BMW X6	--
13078	2011	2016	NISSAN QUEST	--
13079	2011	2017	NISSAN OUTLANDER SPORT	--
	2011	2015	NISSAN OUTLANDER RVR	--
13081	2011	2017	JEEP COMPASS	--
	2011	2017	JEEP PATRIOT	--
13082	1988	1998	CHEV/GMC 1500 PICKUP	--
	1988	2000	CHEV/GMC 2500/3500 PICKUP	--
13083	1983	1994	CHEV/GMC S10 / S15	--
	1991	1994	OLDS BRAVADA	--
13084	1984	2001	JEEP CHEROKEE	--
13085	1994	2003	FORD WINDSTAR	--
13086	1984	1995	TOYO PICKUP, EXCL T100 & TAC	--
13087	1996	2002	TOYO 4 RUNNER	--
13088	1997	2004	INFINITI QX4	--
	1996	2004	NISSAN PATHFINDER	--
13089	1996	1997	LEXUS LX450	--
	1991	1997	TOYO LANDCRUISE	--
13091	1992	2000	NISSAN MONTERO, EXCL SPORT	--
13092	1987	1997	NISSAN PICKUP	--
13093	2011	2016	DODGE CHARGER	--
	2011	2015	CHRYSLER 300C	--
	2011	2016	DODGE CHALLENGER	--
	2012	2015	CHRYSLER 300S	--
13094	1992	1995	TOYO 4 RUNNER W/31.5 TIRES	--

Part#	Yrs From	Yrs To	Make / Model / Style	Repl By
13095	1987	1995	NISSAN PATHFINDER	--
13096	1994	1997	HONDA PASSPORT	--
	1991	1997	ISUZU RODEO	--
13097	1998	2003	DODGE DURANGO	--
13098	1992	2002	ISUZU TROOPER & TROOPER II	--
	1996	1999	ACURA SLX	--
13099	1970	2000	CHEV/GMC FULL SIZE PICKUPS W/10 DROP BUMPER	--
	1963	1996	FORD F-SERIES PICKUPS W/10 DROP BUMPER	--
13100	2011	2017	FORD EXPLORER	--
	2013	2017	FORD POLICE INTERCEPT UTILITY	--
13102	2010	2012	MERCEDES GL350 BLUETEC	--
	2007	2013	MERCEDES GL450	--
	2008	2013	MERCEDES GL550	--
	2010	2013	MERCEDES ML350	--
13103	2006	2009	MERCEDES R320	--
	2006	2012	MERCEDES R350	--
	2006	2012	MERCEDES R500	--
13105	2004	2017	TOYO SIENNA	--
13106	1995	2001	FORD EXPLORER, INCL SPORT	--
	1995	2001	MERCURY MOUNTAINEER	--
13108	2001	2007	CHEV/GMC 2500HD/3500 CLASSIC BODY 6' BOX	--
13109	2012	2017	NISSAN NV1500	--
	2012	2017	NISSAN NV2500	--
	2012	2017	NISSAN NV3500	--
13110	2009	2018	FORD FLEX W DUAL EXHAUST	--
	2010	2017	LINC MKT W ECOBOOST	--
13112	2006	2010	FORD EXPLORER	--
	2006	2010	MERCURY MOUNTAINEER	--
13113	2006	2011	MITSU ENDEAVOR	--
13114	2008	2013	BMW X6	--
13115	2015	2017	KIA SEDONA	--
13116	2011	2017	PORSCHE CAYENNE	--
	2011	2017	VOLKSWAGAN TOUAREG	--
13117	2012	2015	MERCEDES-BENZ ML350 EXCL ACTIVE CURVE SYSTEM	--
	2016	2016	MERCEDES-BENZ GLE350 EXCL ACTIVE CURVE SYSTEM	--
13118	2015	2018	FORD F-150 W/O FACTORY REC	--
13119	2012	2016	HONDA CR-V	--
13120	2010	2016	KIA SPORTAGE	--
	2010	2014	HYUNDAI TUCSON	--
13121	1992	2000	CHEV/GMC SUBURBAN, YUKON, & TAHOE	--
	1992	2000	CAD ESCALADE	--
	1992	1996	CHEV/GMC BLAZE, FULL SIZE	--
13122	2011	2012	VP G MV-1	--
	2014	2016	MOBILITY VENTURES MV-1	--
13125	1997	2002	FORD EXPED.	--
	1998	2002	LINC NAVIGATOR	--
13126	2013	2014	INFINITI JX35	--
	2013	2016	NISSAN PATHFINDER	--
	2014	2017	INFINITI QX60	--
13128	2012	2017	LAND ROVER RANGE ROVER EVO	--
13130	2013	2018	ACURA RDX	--
13131	2013	2018	FORD ESCAPE SE	--
	2013	2018	FORD ESCAPE TITANIUM	--
	2013	2013	FORD ESCAPE SEL	--
13132	1983	2004	CHEV/GMC S10/S15, SONOMA	--
	1996	2000	ISUZU HOMBRE	--
13133	2009	2017	VOLKS TIGUAN	--
13135	2013	2015	SUBARU XV CROSSTREK	--
	2016	2017	SUBARU CROSSTREK	--
13136	2009	2018	AUDI Q5 PREMIUM	--
	2009	2018	AUDI Q5 PREMIUM PLUS	--
	2009	2018	AUDI Q5 PRESTIGE	--
	2010	2016	AUDI Q5 TDI PREMIUM PLUS	--
	2016	2016	AUDI Q5 TDI PREM PLUS S-LINE	--
	2014	2016	AUDI Q5 TDI PRESTIGE	--
	2016	2016	AUDI Q5 TDI PRESTIGE S-LINE	--
	2015	2017	PORSCHE MACAN	--
13138	1983	2011	FORD RANGER	--
	1994	2010	MAZDA B2300, B3000, B4000	--
13140	2013	2015	BMW X1	--
13142	2010	2012	MERCEDES GLK 350	--
13143	2010	2016	LEXUS RX350	--
	2010	2015	LEXUS RX450H	--
13144	2014	2018	SUBARU FORESTER	--
13145	1987	2004	DODGE DAKOTA	--
13146	2014	2017	ACURA MDX	--
	2016	2018	HONDA PILOT	--

Part#	Yrs From	Yrs To	Make / Model / Style	Repl By
13147	2009	2013	SUBARU FORESTER	--
13149	2006	2012	TOYO RAV4 BASE	--
	2016	2017	TOYO RAV4 HYBRID LTD	--
	2016	2017	TOYO RAV4 HYBRID XLE	--
	2013	2017	TOYO RAV4 LE	--
	2006	2017	TOYO RAV4 LTD	--
	2017	2017	TOYO RAV4 PLATINUM	--
	2016	2016	TOYO RAV4 SE	--
	2006	2012	TOYO RAV4 SPORT	--
	2013	2017	TOYO RAV4 XLE	--
13151	1993	1998	JEEP GRAND CHEROKEE	--
13152	2013	2018	HYUN SANTA FE SPRT	--
	2013	2018	HYUN SANTA FE SPRT 2.0T	--
	2017	2018	HYUN SANTA FE SPRT 2.0T ULT	--
	2014	2015	KIA SORENTO	--
13153	2013	2015	HYUNDAI SANTA FE GLS	--
	2013	2017	HYUNDAI SANTA FE LTD	--
	2016	2018	HYUNDAI SANTA FE SE	--
	2017	2018	HYUN SANTA FE LTD ULTIMATE	--
	2017	2018	HYUN SANTA FE SE ULTIMATE	--
13154	2010	2012	ACURA RDX	--
13155	2013	2015	MERCEDES GLK250	--
13156	1997	2001	INFINITI QX4	--
	1996	2004	NISSAN PATHFINDER	--
13157	1996	2002	TOYO 4RUNNER	--
13158	2010	2014	SUBARU LEGACY	--
13160	1984	2001	JEEP CHEROKEE	--
13161	2007	2014	CHEV TAHOE POLICE PACKAGE	--
13162	2000	2006	BMW X5	--
13163	2014	2017	MITSU OUTLANDER	--
13165	2015	2017	CHEV CITY EXPRESS	--
	2013	2017	NISSAN NV200	--
13167	2014	2017	FORD TRANSIT CONNECT	--
13171	2014	2018	JEEP CHEROKEE	--
13172	2014	2018	JEEP CHEROKEE	--
13173	2014	2018	MERCEDES GL350	--
13175	2014	2018	CHEV SILVERADO 1500	--
	2014	2018	GMC SIERRA 1500	--
13176	2015	2017	CHEV COLORADO	--
	2015	2017	GMC CANYON	--
13177	2013	2014	MERCEDES GLK350	--
13178	2015	2018	CHEV SILVER 2500 HD 6' BED	--
	2015	2018	CHEV SILVER 3500 HD 6' BED	--
	2015	2018	GMC SIERRA 2500 HD 6' BED	--
	2015	2018	GMC SIERRA 3500 HD 6' BED	--
13180	2000	2006	TOYO TUNDRA	--
13182	2011	2016	DODGE DURANGO	--
	2017	2017	DODGE DUR W/O FULL SIZE SPR	--
	2011	2017	JEEP GRAND CHEROKEE	--
13183	2000	2004	NISSAN XTERRA	--
13184	2000	2006	TOYO TUNDRA COMPATIBLE W/ TOMMY GATE	--
13186	2013	2018	FORD ESCAPE S	--
	2013	2018	FORD ESCAPE SE	--
	2018	2018	FORD ESCAPE SEL	--
	2013	2018	FORD ESCAPE TITANIUM	--
13187	2015	2016	CHEV SILVER 2500HD/3500HD 8' BED EXCL. WORK TRUCKS	--
	2015	2016	GMC SIERRA 2500HD/3500HD 8' BED EXCL. WORK TRUCKS	--
13188	2004	2010	INFINITI QX56	--
	2005	2015	NISSAN ARMADA	--
	2004	2004	NISSAN PATHFINDER ARMADA	--
13190	2014	2016	MERCE-BENZ GL450/ GL550	--
	2017	2017	MERCE-BENZ GLS450/GLS550	--
13193	2015	2017	FORD TRANSIT-150, 250, 350	--
13194	2015	2018	LINC MKC	--
13195	2016	2018	KIA SORENTO	--
13196	1993	1998	T100 PICKUPS	--
13197	2015	2018	MERCEDES-BENZ GLA250	--
	2015	2018	MERCEDES-BENZ GLA45 AMG	--
	2017	2018	INFINITI QX30	--
13198	2007	2018	TOYO TUNDRA EXCL TRD SPORT, W/O FAC EQUIPPED REC	--
13199	2004	2015	NISSAN TITAN	--
13200	2014	2017	TOYO HIGHLANDER	--
13201	2009	2017	DODGE JOURNEY	--
13203	2015	2017	CHEV COLORADO	--
	2015	2017	GMC CANYON	--

Part#	Yrs From	Yrs To	Make / Model / Style	Repl By
13204	2008	2009	NISSAN ROGUE	--
	2010	2011	NISSAN ROGUE S	--
	2010	2010	NISSAN ROGUE SL	--
	2011	2011	NISSAN ROGUE SV	--
	2012	2017	NISSAN ROGUE	--
	2014	2015	NISSAN ROGUE SELECT	--
13205	2015	2017	NISSAN MURANO	--
13206	2014	2018	SUBARU OUTBACK	--
13207	2014	2017	RAM PROMASTER 1500, 2500, 3500 STD CARGO VAN	--
13208	2001	2010	CHEV/GMC SILVERADO/SIERRA 2500HD/3500 NEW & CLSC BOD	--
13210	2001	2010	CHEV/GMC SILVERADO/SIERRA 2500HD/3500 NEW & CLSC BOD	--
13211	2001	2010	CHEV/GMC SILVERADO/SIERRA 2500HD/3500 NEW & CLSC BOD	--
13212	2001	2010	CHEV/GMC SILVERADO/SIERRA 2500HD/3500 6' BED COMPAT W/ TOM GATE LIFTS	--
13213	2001	2009	CHEV/GMC SILVERADO/SIERRA 2500HD/3500 8' BED COMPAT W/ TOMMY GATE LIFTS	--
13215	2015	2017	RAM PROMASTER CITY	--
13217	1993	2003	VOLKS EUROVAN/TRANSPORTR	--
13220	2007	2015	AUDI Q7	--
	2004	2010	PORSCHE CAYENNE	--
	2004	2010	VOLKS TOUAREG/COLORADO	--
13222	1998	2002	HONDA PASSPORT	--
	1998	2004	ISUZU RODEO W/ SPARE	--
13223	1997	2004	MITSU MONTERO SPORT	--
13229	2005	2011	DODGE DAKOTA	--
	2006	2009	MITSU RAIDER	--
13230	2005	2011	DODGE DAKOTA	--
13233	2016	2017	VOLVO XC90	--
13234	2015	2017	FORD EDGE	--
13235	1998	2002	HONDA PASSPORT W/DOOR MOUNTED SPARE, EXCL 3.2L	--
	1989	2000	ISUZU AMIGO, EXCL 3.2L	--
	1998	2004	ISUZU RODEO W/DOOR SPARE	--
13236	2011	2018	DODGE CHALLENGER	--
	2011	2017	DODGE CHARGER	--
	2015	2017	CHRYSLER 300S	--
13238	2015	2018	AUDI Q3 / Q3 QUATTRO	--
13240	2016	2017	HYUNDAI TUCSON ECO, LTD, SPORT, SE	--
13241	2005	2017	NISSAN FRONTIER	--
	2009	2012	SUZUKI EQUATOR	--
13243	2014	2016	LAND ROVER RANGE RIVER SPRT	--
13244	2001	2007	JEEP LIBERTY	--
13245	2008	2012	JEEP LIBERTY	--
13247	2015	2017	LAND ROVER DISCOV SPORT	--
13250	2003	2006	DODGE SPRINTER, EXCL 140 WB W/DUAL REAR WHEELS	--
13251	2005	2010	JEEP GRAND CHEROKEE	--
13252	2004	2011	CHEV/GMC COLORADO/CANYON ISUZU I-SERIES PICKUPS	--
13255	2007	2015	DODGE SPRINTER W/STD BUMP	--
	2010	2016	MERCEDES-BENZ SPRINTER CV 2500 W/ STANDARD BUMPER	--
	2010	2016	MERCEDES-BENZ SPRINTER CV 3500 170 WB W/ STD BUMPER	--
	2007	2016	FREIGHTLINER SPRINTER 2500 CV STANDARD BUMPER	--
	2007	2016	FREIGHTLINER SPRINTER 3500 CV STD BUMPER W/170 WB	--
13262	2016	2017	LINC MKX	--
13264	2016	2017	TOYO TACOMA	--
13265	2003	2006	DODGE SPRINTER W/140WB & DUAL REAR WHEELS	--
13268	2010	2017	VOLVO XC60	--
13269	2015	2017	JEEP RENEGADE	--
13266	2008	2009	VOLVO V70 WAGON	--
	2008	2015	VOLVO XC70 AWD WAGON	--
	2011	2016	VOLVO S60 SED	--
	2015	2016	VOLVO V60	--
13270	2006	2010	HUMMER H3	--
13271	2016	2017	FIAT 500X	--
13272	2016	2017	LEXUS RX350	--
13275	2007	2011	DODGE/FREIGHTLINER/MERCE SPRINT CAB & CHASSIS	--
13276	2016	2017	MERCEDES-BENZ METRIS	--
13277	2017	2018	AUDI Q7	--

Part#	Yrs From	Yrs To	Make / Model / Style	Repl By
13280	1987	2004	DODGE DAKOTA	--
13281	2017	2018	KIA SPORTAGE	--
13282	2016	2017	LEXUS RX450H	--
13284	2016	2017	MAZDA CX-9	--
13285	2017	2018	CAD XT5 BASE	--
	2017	2018	CAD XT5 LUXURY	--
	2017	2018	CAD XT5 PREMIUM LUXURY	--
13286	2017	2018	CHRYSLER PACIFICA LTD	--
	2017	2018	CHRYSLER PACIFICA LX	--
	2017	2018	CHRYSLER PACIFICA TOURING	--
	2017	2018	CHRYSLER PACIFICA TOURING L	--
	2017	2018	CHRY PACIFICA TOUR L PLUS	--
13287	2011	2016	FORD RANGER	--
13290	2016	2017	MERCEDES-BENZ GLC300	--
13291	2017	2018	JAGUAR F-PACE	--
13292	2016	2018	BUICK ENVISION	--
13293	2017	2018	GMC ACADIA	--
13294	2016	2017	MERCEDES-BENZ GLE350	--
13295	2014	2017	RAM PROMASTER 1500	--
	2014	2017	RAM PROMASTER 2500	--
	2014	2017	RAM PROMASTER 3500	--
13296	2007	2009	CHRYSLER ASPEN	--
	2007	2009	DODGE DURANGO	--
13297	2004	2006	DODGE DURANGO	--
13300	1995	2004	CHEV/GMC S10 / S15	--
	1999	2001	CHEV BLAZE / TRLBLAZE	--
	1999	2000	GMC JIMMY ENVOY	--
	1995	2002	OLDS BRAVADA	--
13301	2007	2007	CHEV SILVERADO 1500 CLSC	--
	2007	2007	CHEV SILVER 1500 HD CLASSIC	--
	2007	2018	CHEV SILVERADO 1500	--
	2007	2007	GMC SIERRA 1500 CLASSIC	--
	2007	2007	GMC SIERRA 1500 HD CLASSIC	--
	2007	2018	GMC SIERRA 1500	--
13303	2016	2018	BMW X1	--
13304	2017	2017	NISSAN TITAN S	--
	2017	2017	NISSAN TITAN SV	--
13305	2017	2017	VOLVO S90	--
13306	2017	2018	HONDA CR-V	--
13307	2018	2018	CHEV EQUINOX	--
	2018	2018	GMC TERRAIN	--
13309	2017	2017	NISSAN PATHFINDER S	--
	2017	2017	NISSAN PATHFINDER SL	--
	2017	2017	NISSAN PATHFINDER SV	--
13310	1967	2002	DODGE FULL SIZE PICKUPS	--
	1978	1997	FORD BRONCO	--
	1973	1997	FORD F-SERIES PICKUPS	--
13314	1997	2001	HONDA CRV	--
13315	2013	2017	MAZDA CX-5	--
13316	2011	2017	BMW X3	--
	2015	2018	BMW X4	--
13317	2016	2017	NISS TITAN XD S, W/O FAC REC	--
13318	2002	2008	MERCEDES G500 463 CHASSIS	--
13320	2002	2003	DODGE RAM 1500, 6' BED	--
13322	2007	2013	CHEV/GMC SILVERADO/SIERRA 1500 NEW BODY	--
	1999	2007	CHEV/GMC SILVERADO/SIERRA 1500/2500LD CLASSIC BODY	--
13323	2005	2016	TOYO TACOMA	--
13326	2003	2008	DODGE RAM NEW BOD, OEM-ST	--
13328	2001	2006	ACURA MDX	--
	2001	2008	HONDA PILOT	--
13329	2017	2018	KIA NIRO	--
13331	2018	2018	AUDI Q5	--
13332	1999	2007	CHEV/GMC SILVERADO/SIERRA 1500/2500LD CLASSIC BODY	--
13333	2003	2010	DODGE RAM 1500 EXCL FAC REC	--
	2003	2010	DODGE RAM 2500 EXCL W FAC REC	--
	2003	2010	DODGE RAM 3500 EXCL W FAC REC	--
	2011	2018	RAM 1500 EXCL W FACT REC	--
	2011	2017	RAM 2500 EXCL W FACT REC	--
	2011	2017	RAM 3500 EXCL W FACT REC	--
13334	2007	2011	DODGE NITRO	--
13336	2005	2007	BUICK TERAZZA	--
	2005	2008	CHEV UPLANDER 121 WB ONLY	--
	2005	2007	PONTIA MONTANA SV6 121 WB	--
	2005	2007	SATURN RELAY	--
13339	1999	2012	CHEV/GMC 1500 & 2500LD FITS W/ 10 DROP BUMPER & TOMMY GATE LIFTS	--
13340	2002	2005	KIA SEDONA	--
13342	2006	2011	MERCEDES M-SERIES SUV	--
13343	2011	2017	TOYO SIENNA	--

Part#	Yrs From	Yrs To	Make / Model / Style	Repl By
13344	2005	2007	BUICK TERAZZA	--
	2005	2008	CHEV UPLANDER	--
	2009	2009	CHEV UPLANDER, CANADA OLY	--
	1997	2007	CHEV VENTURE	--
	1997	2005	OLDS SILHOUETTE	--
	2005	2007	PONTIAC MONTANA SV6	--
	2008	2009	PONTIAC MONTANA SV6, CANADA ONLY	--
	1997	2005	PONTIAC TRANS SPORT	--
	2005	2007	SATURN RELAY	--
13345	2007	2009	HYUNDAI ENTOURAGE	--
	2006	2014	KIA SEDONA (LONG WHE BASE)	--
13349	2007	2010	KIA SEDONA (SRT WHE BASE)	--
13352	2004	2005	FORD F-150, ALL	--
13354	2007	2013	ACURA MDX W/O FULLSIZE SPR	--
13355	1997	2003	FORD F-150 & F-250LD	--
	1999	2016	FORD F-250 & F-350 SD	--
	2008	2016	FORD F-450 SD	--
13356	2009	2016	TOYO VENZA	--
13357	2004	2005	FORD F-150, ALL	--
13358	2007	2015	DODGE/FREIGHTLINER/ MERCEDES-BENZ SPRINTER 2500 CV W/STEP BUMPER	--
	2010	2016	MERCEDES-BENZ SPRINT 3500 CV 170 WB W/STEP BUMPER	--
	2007	2016	FREIGHTLINER SPRINTER 2500 CV STEP BUMPER	--
	2007	2016	FREIGHTLINER SPRINTER 3500 CV FACT STEP BUMPER & 170 WB	--
13359	1997	2003	FORD F-150 & F-250LD	--
	1999	2015	FORD F-250 & F-350 SD	--
	2008	2015	FORD F-450 SD	--
13360	2006	2008	FORD F-150	--
	2006	2008	LINC MARK LT PICKUP	--
13361	2002	2010	DODGERAM 1500 EXCL W FAC REC	--
	2003	2010	DODGERAM 2500 EXCL W FAC REC	--
	2003	2008	DODGE RAM 3500 EXCL W FAC REC	--
	2011	2017	RAM 2500 EXCL W FACTO REC	--
	2011	2016	RAM 3500 EXCL W FACTO REC	--
13362	1997	2007	CHRYSLER TOWN & COUNTRY, EXCL STOW & GO	--
	1997	2007	DODGE CARAVAN/GRAND CARAVAN, EXCL STOW & GO	--
	1997	2004	PLYMOUTH VOYAGER/GRAND VOYAGER	--
13363	2017	2017	JEEP COMPASS LTD / SPORT / TRLHAWK / LATITUDE 11TH DIGIT OF VIN IS 'T'	--
	2018	2018	JEEP COMPASS LTD / LATITUDE	--
	2018	2018	JEEP COMPASS TRAILHAWK	--
	2018	2018	JEEP COMPASS SPORT	--
13364	2008	2017	DODGE GRAND CARAVAN W STOW 'N GO	--
	2008	2016	CHRYSLER TOWN & COUNTRY	--
	2012	2016	RAM CARGO VAN	--
	2009	2014	VOLKS ROUTAN	--
13365	2006	2008	FORD F-150	--
	2006	2008	LINC MARK LT PICKUP	--
13366	2018	2018	VOLKS ATLAS	--
13367	2007	2014	TOYO FJ CRUISE	--
13368	2009	2014	FORD F-150 STYLSID & SPRCRW	--
13369	--	--	MULTI-FIT	--
13370	2018	2018	HONDA ODYSSEY	--
13371	2009	2014	FORD F-150 STYLSID & SPRCRW	--
13372	2006	2008	FORD F-150 (BUILT AFTER 8/5/05) COMPATIBLE W/ TOMMY GATE LIFTS	--
13373	2004	2005	FORD F150, COMPATIBLE W/ TOMMY GATE LIFTS	--
13374	2009	2010	DODGERAM 1500 EXCL W FAC REC	--
	2011	2018	RAM 1500 EXCL W FACTOR REC	--
13375	2007	2015	DODGE	--
	2010	2016	MERCEDES SPRINTER 3500 CV, 144 WB W/ FACT STEP BUMPER	--
	2007	2016	FREIGHTLINER SPRINTER 3500 CV FACT STEP BUMPER 144 WB	--
13377	2017	2017	NISSAN ROGUE SPORT S, SL, SV	--
13379	2010	2017	FORD TAURUS LTD, SE, SEL, SHO	--

Part#	Yrs From	Yrs To	Make / Model / Style	Repl By
13380	2018	2018	CHEV TRAVERSE HIGH CTRY	--
	2018	2018	CHEV TRAVERSE L	--
	2018	2018	CHEV TRAVERSE LS	--
	2018	2018	CHEV TRAVERSE LT	--
	2018	2018	CHEV TRAVERSE PREMIER	--
	2018	2018	CHEV TRAVERSE RS	--
13381	2018	2018	VOLKS TIGUAN SE	--
	2018	2018	VOLKS TIGUAN SEL PREMIUM	--
	2018	2018	VOLKS TIGUAN SEL	--
	2018	2018	VOLKS TIGUAN S	--
13382	2018	2018	SUBARU CROSSTREK BASE	--
	2018	2018	SUBARU CROSSTREK LTD	--
	2018	2018	SUBARU CROSSTREK PREMIER	--
13385	2005	2014	HONDA RIDGELINE	--
13389	2004	2007	CHRYSLER TOWN & COUNTRY W/STOW & GO	--
	2004	2007	DODGE GRAND CARAVAN W/STOW & GO	--
13390	2015	2017	SUBARU LEGACY	--
	2010	2013	SUBARU OUTBACK SED & WAG	--
	2010	2011	SUBARU OUTBACK SPORT (CANADIAN BUILT)	--
13401	1973	1991	CHEV/GMC BLAZE/JIM FULL SIZE	--
13402	2002	2002	CHEV/GMC AVALANCHE	--
	2000	2002	CHEV/GMC SUBURBAN, YUKON XL, TAHOE, & DENALI	--
	2000	2002	CAD ESCALADE	--
13407	2000	2006	FORD EXPLORER SPORT TRAC	--
13408	1997	2006	JEEP WRANGLER	--
13412	1978	1996	JEEP CJ5/CJ7	--
13414	2006	2009	JEEP COMMANDER	--
13422	2003	2006	CAD ESCALADE	--
	2003	2006	CHEV AVALANCHE	--
	2003	2006	CHEV/GMC SUBURBAN, YUKON XL, TAHOE, & DENALI	--
13424	2008	2017	BUICK ENCLAVE	--
	2009	2017	CHEV TRAVERSE	--
	2007	2016	GMC ACADIA	--
	2007	2010	SATURN OUTLOOK	--
	2017	2017	GMC ACADIA LTD	--
13429	1999	2003	LEXUS RX 300	--
	2001	2003	TOYO HIGHLANDER	--
13430	1997	2006	JEEP WRANGLER ALL	--
13432	2007	2017	JEEP WRANGLER	--
13440	2001	2007	TOYO SEQUOIA	--
13442	2008	2011	TOYO SEQUOIA SR5	--
13443	1998	2007	LEXUS LX470	--
	1998	2007	TOYO LANDCRUISE	--
13445	2003	2009	LEXUS GX470	--
	2003	2009	TOYO 4RUNNER	--
13450	2001	2005	LAND ROVER FREELANDER	--
13455	1998	2004	LAND ROVER DISCOVERY	--
13456	2005	2009	LAND ROVER LR3	--
	2010	2016	LAND ROVER LR4	--
	2006	2013	LAND ROVER RANGE ROVER SPORT HSE	--
13465	2005	2010	CHRYSLER 300	--
	2004	2009	CHRYSLER 300C, TOUR & LTD	--
	2009	2010	DODGE CHALLENGER	--
	2006	2010	DODGE CHARGER	--
	2004	2008	DODGE MAGNUM	--
13469	2002	2007	BUICK RENDEZVOUS	--
	2001	2005	PONTIAC AZTEK	--
13505	2001	2006	HYUNDAI SANTA FE	--
13506	2001	2004	FORD ESCAPE	--
	2001	2004	MAZDA TRIBUTE	--
13511	1998	2003	TOYO SIENNA	--
13513	2003	2009	KIA SORENTO	--
13514	2005	2015	NISSAN XTERRA	--
13517	1999	2005	CHEV/GEO TRACKER	--
	1999	2005	SUZUKI VITARA & GRND VITARA	--
	2002	2006	SUZUKI XL7	--
13518	2007	2009	SUZUKI XL7	--
13524	1996	2005	TOYO RAV4	--
13526	2004	2009	HYUNDAI TUCSON	--
	2004	2010	KIA SPORTAGE	--
13529	2004	2008	CHRYSLER PACIFICA	--
13530	2004	2009	LEXUS RX 330/350/400	--
	2004	2007	TOYO HIGHLANDER	--
13534	2008	2013	TOYO HIGHLANDER	--
13535	2002	2006	HONDA CRV	--
13536	2007	2009	ACURA RDX	--
13537	1995	2004	KIA SPORTAGE	--

Part#	Yrs From	Yrs To	Make / Model / Style	Repl By
13538	2007	2009	HYUNDAI SANTA FE	--
13540	1995	2001	FORD EXPLORER, INCL SPORT	--
	1991	1994	MAZDA NAVAJO	
	1996	2001	MERCURY MOUNTAINEER	
13542	2005	2008	FORD F500	--
	2008	2009	FORD TAURUS	
	2005	2008	FORD FREESTYLE	
	2005	2008	MERCURY MONTEGO	
	2008	2009	MERCURY SABLE	
13545	2007	2012	HYUNDAI VERACRUZ	--
13548	2007	2010	JEEP COMPASS & PATRIOT	--
13550	2002	2005	FORD EXPLORER	--
	2002	2005	MERCURY MOUNTAINEER	
13551	2009	2018	FORD FLEX W/O DUAL EXHAUST	--
13552	2010	2017	FORD TAURUS	--
13554	2009	2012	INFINITI FX35	--
	2009	2014	INFINITI FX37	
	2009	2013	INFINITI FX50	
	2014	2017	INFINITI QX70	
13555	2007	2011	HONDA CRV	--
13556	1999	2001	ISUZU VEHICROSS	--
13558	2003	2008	INFINITI FX35/FX45	--
13559	2003	2014	VOLVO XC90	--
13563	2003	2009	NISSAN QUEST	--
13569	2003	2005	NISSAN ENDEAVOR	--
13571	2003	2007	NISSAN MURANO	--
13572	1999	2002	NISSAN QUEST	--
	1999	2002	MERCURY VILLAGER	
13573	2004	2010	BMW X3	--
13574	2003	2011	HONDA ELEMENT, EXCL SC	--
13575	2007	2015	MAZDA CX-9	--
13577	2009	2014	NISSAN MURANO	--
13580	1971	1980	INTERNATIONAL SCOUT II, TERRA, & TRAVELER	--
13581	2007	2013	NISSAN OUTLANDER	--
13587	2004	2007	FORD FREESTAR	--
	2004	2007	MERCURY MONTEREY VAN	
13590	1997	2007	DODGE FULL SIZE VAN, W/STEP BUMPER	--
13591	2005	2017	CHEV EQUINOX	--
	2010	2017	GMC TERRAIN	
	2006	2009	PONTIAC TORRENT	
	2002	2007	SATURN VUE	
13593	2007	2012	MAZDA CX-7	--
13594	2008	2009	SATURN VUE, INCL REDLINE	--
	2012	2015	CHEV CAPTIVA	
13650	2005	2012	FORD ESCAPE	--
	2005	2011	MAZDA TRIBUTE	
	2005	2011	MERCURY MARINER	
13651	2005	2011	FORD ESCAPE W/ FACTORY 1-1/4 REC HITCH	--
	2005	2011	MERCURY MARINER W/ FACTORY 1-1/4 REC HITCH	
	2005	2011	MAZDA TRIBUTE W/ FACTORY 1-1/4 REC HITCH	
13657	1986	1996	JEEP WRANGLER, RENEGADE	--
13701	--	--	ADJUSTABLE RV 2DROP	--
13702	--	--	ADJUSTABLE RV NO DROP	--
13703	--	--	ADJUSTABLE RV HITCH	--
13707	1979	2011	FORD LTD/CROWN VICTORIA	--
	1980	1983	LINC MARK VI	
	1980	2011	LINC TOWN CAR	
	1979	1991	MERCURY COLONY PARK WAG	
	1983	2009	MERCURY GRND MARQUIS SED	
	1979	1982	MERCURY GRND MARQUIS WAG	
	2003	2004	MERCURY MARAUDER	
	1987	1991	FORD COUNTRY SQUIRE	
13800	2001	2006	NISSAN MONTERO, EXCL SPORT	--
13831	2000	2004	NISSAN FRONTI 2DR SRT BOX	--
13841	2000	2004	NISSAN FRONTI 4DR SRT BOX	--
13842	2003	2004	NISSAN FRONTIER LONG BOX	--
13902	--	--	MULTI-FIT, SEE PAGE 18	--
13903	2006	2017	MULTI-FIT, FORD F-150, PG 17	--
13920	1982	2004	CHEV/GMC S10/S15, SONOMA	--
13932	1999	2007	CHEV/GMC SILVERADO/SIERRA 1500/2500LD CLASSIC W/ ROLL PAN	--
13942	1988	1998	CHEV/GMC 1500 PICKUP W/ ROLL PAN BUMPER	--
14000	2012	2017	NISSAN NV1500	--
	2012	2017	NISSAN NV2500	
	2012	2017	NISSAN NV3500	

Part#	Yrs From	Yrs To	Make / Model / Style	Repl By
14001	1967	2002	DODGE FULL SIZE PICKUPS	--
	1978	1997	FORD BRONCO	
	1973	1997	FORD F-SERIES PICKUPS	
14002	2009	2014	FORD F-150	--
14006	2014	2018	CHEV SILVERADO 1500	--
	2014	2018	GMC SIERRA 1500	
14008	2001	2007	CHEV/GMC SILVERADO/SIERRA 2500HD/3500 CLASSIC BODY 8' BED ONLY	--
14009	2015	2018	CHEV SILVER 2500 HD 6' BED	--
	2015	2018	CHEV SILVER 3500 HD 6' BED	
	2015	2018	GMC SIERRA 2500 HD 6' BED	
	2015	2018	GMC SIERRA 3500 HD 6' BED	
14010	2015	2017	CHEV SILVER 2500 HD 8' BED	--
	2015	2017	CHEV SILVER 3500 HD 8' BED	
	2015	2017	GMC SIERRA 2500 HD 8' BED	
	2015	2017	GMC SIERRA 3500 HD 8' BED	
14011	2000	2005	FORD EXCURSION	--
14012	2015	2017	FORD TRANSIT-150	--
	2015	2017	FORD TRANSIT-250	
	2015	2017	FORD TRANSIT-350	
14016	2015	2018	FORD F-150 W FACTORY REC	--
14017	2015	2018	FORD F-150 W/O FACTORY REC	--
14020	2002	2003	DODGE RAM 1500, 6' BED	--
14029	1992	2000	CHEV/GMC SUBURBAN, YUKON, & TAHOE	--
	1992	2000	CAD ESCALADE	
	1992	1996	CHEV/GMC BLAZE, FULL SIZE	
14048	1999	2017	FORD F-350 SD CAB & CHASSIS W 34 IN FRAME	--
	1999	2017	FORD F-450 SD CAB & CHASSIS W 34 IN FRAME	
	1999	2017	FORD F-550 SD CAB & CHASSIS W 34 IN FRAME	
	1999	2016	FORD F-650 SD CAB & CHASSIS W 34 IN FRAME	
14053	1975	2006	FORD ECONOLINE VAN E-SER	--
14055	2000	2014	FORD ECONOLINE VAN E-SER	--
14061	2011	2014	CHEV/GMC SILVERADO/SIERRA 2500HD/3500 LONG BOX	--
14062	2011	2014	CHEV/GMC SILVERADO/SIERRA 2500HD/3500 SHORT BOX	--
14070	2007	2010	DODGE RAM 3500 CAB & CHAS	--
	2008	2010	DODGE RAM 4500	
	2008	2010	DODGE RAM 5500	
	2011	2017	RAM 3500 CAB & CHASSIS	
	2011	2017	RAM 4500	
	2011	2017	RAM 5500	
14080	2000	2002	CAD ESCALADE	--
	2002	2002	CHEV AVALANCHE	
	2000	2002	CHEV/GMC SUBURBAN, YUKON XL, TAHOE, & DENALI	
14081	1988	1998	CHEV/GMC 1500 PICKUP	--
	1988	2000	CHEV/GMC 2500/3500 PICKUP	
14082	1973	2006	CHEV/GMC CAB & CHASSIS, 34 FRAME	--
	1973	1979	FORD F-250 CREW CAB	
	1973	2006	FORD CAB & CHASSIS, 34 FRAME	
14090	1996	2014	CHEV EXPRESS 1500 EXCL CUTAWAY MODELS	--
	1996	2017	CHEV EXPRESS 2500 EXCL CUTAWAY MODELS	
	1996	2017	CHEV EXPRESS 3500 EXCL CUTAWAY MODELS	
	1996	2014	GMC SAVANA 1500 EXCL CUTAWAY MODELS	
	1996	2017	GMC SAVANA 2500 EXCL CUTAWAY MODELS	
	1996	2017	GMC SAVANA 3500 EXCL CUTAWAY MODELS	
14108	2001	2007	CHEV/GMC SILVERADO/SIERRA 2500HD/3500 CLSC BODY 6' BED	--
14211	2001	2010	CHEV/GMC SILVERADO/SIERRA 2500HD/3500 NEW & CLSC BOD	--
14250	2003	2006	DODGE SPRINTER, EXCL 140 WB W/DUAL REAR WHEELS	--
14258	2016	2017	RAM 2500 6' BED W/O FACTORY REC	--
	2016	2017	RAM 3500 6' BED W/O FACTORY REC	

Part#	Yrs From	Yrs To	Make / Model / Style	Repl By
14301	2007	2007	CHEV SILVERADO 1500 CLASS	--
	2007	2007	CHEV SILVER 1500 HD CLASSIC	
	2007	2018	CHEV SILVERADO 1500	
	2007	2007	GMC SIERRA 1500 CLASSIC	
	2007	2007	GMC SIERRA 1500 HD CLASSIC	
	2007	2018	GMC SIERRA 1500	
14332	1999	2007	CHEV/GMC SILVERADO/SIERRA 1500/2500LD CLASSIC BODY	--
14355	1997	2003	FORD F-150 & F-250LD	--
	1999	2015	FORD F-250 & F-350 SD	
	2008	2016	FORD F-450 SD	
14357	2004	2005	FORD F-150	--
14360	2006	2008	FORD F-150	--
	2006	2008	LINC MARK LT PICKUP	
14361	2002	2016	DODGE RAM PICKUPS NEW BOD	--
14374	2009	2010	DODGE RAM 1500 W/O FAC REC	--
	2011	2018	RAM 1500 W/O FACTORY REC	
15300	1973	1997	FORD F-SERIES	--
	1978	1997	FORD BRONCO	
	1967	2002	DODGE FULL SIZE	
15302	2001	2010	CHEV/GMC SILVERADO/SIERRA 2500HD/3500 6' BED	--
15303	1997	2003	FORD F-150 & F-250LD	--
15306	2016	2017	NISSAN TITAN XD	--
15312	2001	2010	CHEV/GMC SILVERADO/SIERRA 2500HD & 3500	--
15313	2001	2010	CHEV/GMC SILVERADO/SIERRA 2500HD & 3500	--
15316	1999	2003	FORD F-250/F-350 SD	--
15317	1988	2000	CHEV/GMC 2500 & 3500 C/K SERIES	--
15318	1999	2002	DODGE RAM 2500/3500	--
	1994	1998	DODGE RAM 2500/3500	
15319	1994	2002	DODGE RAM 2500/3500 LONG BED W FACTORY BUMPER	--
15320	1996	2016	CHEV/GMC EXPRESS/SAVANA	--
15323	1999	2014	CHEV/GMC SILVERADO/SIERRA 1500	--
15324	2003	2006	CAD ESCALADE	--
	2003	2006	CHEV/GMC AVALANCHE	
	2003	2006	CHEV/GMC SUBURBAN,TAHOE,YUKON	
15325	1988	2000	CHEV/GMC 2500 & 3500 C/K SERIES	--
15363	2011	2012	CHEV/GMC SILVERADO/SIERRA 2500 & 3500 8' BED, BOX	--
15398	2007	2017	TOYO TUNDRA	--
15400	2001	2016	CHEV/GMC SILVERADO/SIERRA 3500 CAB & CHASSIS	--
	2007	2010	DODGE RAM 3500 CAB & CHASSIS	
	2008	2010	DODGE RAM 4500	
	2008	2010	DODGE RAM 5500	
	2011	2017	RAM 3500 CAB & CHASSIS	
	2011	2017	RAM 4500	
	2011	2017	RAM 5500	
15401	2016	2016	RAM 2500/3500 SHORT BOX	--
15409	2003	2008	DODGE RAM 1500	--
	2003	2017	DODGE RAM 2500	
	2003	2013	DODGE RAM 3500	
15410	1999	2016	FORD F-250 & F-350 SD	--
15445	1999	2017	FORD F-350 SD CAB & CHASSIS W 34 IN FRAME	--
	1999	2017	FORD F-450 SD CAB & CHASSIS W 34 IN FRAME	
	1999	2017	FORD F-550 SD CAB & CHASSIS W 34 IN FRAME	
	1999	2016	FORD F-650 SD CAB & CHASSIS W 34 IN FRAME	
15460	2011	2018	CHEV/GMC SILVERADO/SIERRA 2500HD/3500 SHORT BOX	--
15510	--	--	MULTI-FIT, SEE PAGE 20	--
15511	--	--	MULTI-FIT, SEE PAGE 20	--
15572	2009	2010	DODGE RAM 1500 EXCL FAC REC	--
	2011	2018	RAM 1500 EXCL FACTORY REC	
15703	2001	2010	CHEV/GMC SILVERADO/SIERRA 2500HD & 3500	--
15704	2003	2015	DODGE RAM 2500	--
	2003	2015	DODGE RAM 3500	

Part#	Yrs From	Yrs To	Make / Model / Style	Repl By
15800	2001	2016	CHEV/GMC SILVERADO/SIERRA 3500 CAB & CHASSIS	--
	2007	2016	DODGE RAM 3500 CAB & CHASSIS	--
	2008	2010	DODGE RAM 4500/5500 CAB & CHASSIS	--
	2011	2017	RAM 3500 CAB & CHASSIS	--
	2011	2017	RAM 4500	--
	2011	2017	RAM 5500	--
15801	2016	2016	RAM 2500/3500 SHORT BOX	--
15802	2017	2018	FORD F-250 SD	--
	2017	2017	FORD F-350 SD CREW CAB	--
	2017	2017	FORD F-350 SD EXTENDED CAB	--
	2017	2017	FORD F-350 SD STANDARD CAB	--
	2017	2017	FORD F-450 SD CREW CAB	--
15803	2014	2017	RAM 3500	--
15808	2014	2016	RAM 3500	15803
15809	2003	2008	DODGE RAM 1500	--
	2003	2016	DODGE RAM 2500	--
	2003	2015	DODGE RAM 3500	--
15810	1999	2016	FORD F-250/F-350 SD	--
	2008	2015	FORD F-450 SD	--
15845	1999	2017	FORD F-350 SD CAB & CHASSIS W 34 IN FRAME	--
	1999	2017	FORD F-450 SD CAB & CHASSIS W 34 IN FRAME	--
	1999	2017	FORD F-550 SD CAB & CHASSIS W 34 IN FRAME	--
	1999	2016	FORD F-650 SD CAB & CHASSIS W 34 IN FRAME	--
15860	2011	2018	CHEV SILVERADO 2500 HD	--
	2011	2018	CHEV SILVERADO 3500 HD	--
	2011	2018	GMC SIERRA 2500 HD	--
	2011	2018	GMC SIERRA 3500 HD	--
15901	--	--	UNIVERSAL WELD-ON REC W/5DROP	--
15902	--	--	UNIVERSAL WELD-ON REC W/13.5DROP, 12K	--
31008	2008	2010	FORD F-250/F-350/F-450/F-550 SD & CAB/CHASSIS	--
31012	2007	2014	CAD ESCALADE	--
	2007	2013	CHEV AVALANCHE	--
	2007	2014	CHEV SUBURBAN	--
	2014	2018	CHEV SILVERADO 1500	--
	2014	2018	GMC SIERRA 1500	--
	2007	2014	CHEV TAHOE	--
	2007	2014	GMC YUKON	--
31013	2001	2004	TOYO TACOMA	--
31014	1999	2003	FORD F-250/350 SD W/ BLOCKER BEAM	--
	2000	2003	FORD EXCURSION	--
31015	2010	2010	DODGE RAM 2500 4WD	--
	2011	2016	RAM 2500 4WD	--
31016	1996	2003	CHEV/GMC EXPRESS & SAVANA FULL SIZE VANS	--
31017	2006	2008	DODGE RAM 1500 MEGA CAB	--
	2003	2009	DODGE RAM 2500/3500	--
31018	2011	2015	FORD F-250/F-350 SD 4X4	--
31020	2008	2013	JEEP LIBERTY	--
31021	1994	2001	CHEV/GMC S10/S15 4WD	--
31022	2002	2007	JEEP LIBERTY 4WD	--
31023	2011	2014	CHEV/GMC SILVERADO/SIERRA 2500HD/3500	--
31024	2009	2011	HONDA PILOT	--
31025	2011	2012	FORD ESCAPE	--
	2011	2011	MERCURY MARINER	--
31026	1992	1996	FORD F-150	--
31028	1997	2006	JEEP WRANGLER	--
31029	2001	2006	FORD EXPLORER SPORT TRAC	--
31030	2010	2012	CHEV/GMC Z71 CLRDO/CANYON	--
31032	2010	2013	CHEV EQUINOX	--
	2010	2013	GMC TERRAIN	--
31033	2011	2011	JEEP GRAND CHEROKEE	--
	2012	2017	JEEP GRAND CHEROKEE	--
	2014	2017	JEEP GRAND CHEROKEE SUMM	--
	2016	2016	JEEP GRAND CHEROKEE 75TH ANNY, W/O FACT TOW HOOKS	--
	2011	2013	DODGE DURANGO CITADEL	--
	2011	2013	DODGE DURANGO CREW,	--
	2011	2011	DODGE DURANGO EXPRESS	--
	2012	2013	DODGE DURANGO SPECIAL	--
	2013	2013	DODGE DURANGO SXT	--
	2014	2017	DODGE DURANGO	--

Part#	Yrs From	Yrs To	Make / Model / Style	Repl By
31034	2010	2011	HYUNDAI SANTA FE	--
31035	2007	2009	HYUNDAI SANTA FE	--
31038	1999	2003	FORD F-150 & F-250LD 4WD W/FACTORY TOW HOOKS	--
	2004	2004	FORD F-150 HERITAGE	--
31042	1992	1994	CHEV/GMC BLAZE, FULLSIZE	--
	1992	1999	CHEV/GMC SUBURBAN & YUKON	--
	1995	1999	CHEV/GMC TAHOE	--
	1988	1998	CHEV/GMC 1500 PICKUPS	--
	1988	2000	CHEV/GMC 2500/3500 PICKUPS 4WD ONLY	--
31043	1988	2000	CHEV/GMC 2500/3500 PICKUP 2WD ONLY	--
	1992	1999	CHEV/GMC SUBURBAN WD OLY	--
31045	2008	2012	BUICK ENCLAVE	--
	2009	2012	CHEV TRAVERSE	--
	2009	2012	GMC ACADIA	--
31047	2005	2010	JEEP GRAND CHEROKEE	--
31048	2002	2004	JEEP GRAND CHEROKEE	--
31049	1997	1998	FORD EXPED. 4WD W/FACTORY TOW HOOKS	--
	1997	1998	FORD F-150 & F-250LD	--
31050	2011	2013	FORD EDGE EXCL ECOBOOST	--
31051	1997	2001	FORD EXPLORER	--
31052	2011	2016	FORD EXPLORER, EXCL ECOBO	--
31053	2008	2014	FORD E-150	--
	2008	2014	FORD E-250	--
	2008	2014	FORD E-350 SD	--
31054	2010	2013	TOYO 4RUNNER SR5	--
	2010	2017	TOYO 4RUNNER LTD	--
31055	2002	2008	BUICK RANIER	--
	2002	2008	CHEV/GMC TRAILBLAZE, ENVOY, & DENALI	--
31056	2006	2010	JEEP COMMANDER	--
31061	2009	2015	NISSAN TITAN 4WD	--
31063	1992	2011	FORD RANGER	--
31064	2012	2015	HONDA PILOT	--
31065	2010	2012	DODGE RAM 3500	--
31067	2013	2016	RAM 3500 CREW CAB	--
	2013	2016	RAM 3500 EXTENDED CAB	--
	2013	2016	RAM 3500 STANDARD CAB	--
	2017	2017	RAM 3500	--
31068	2009	2017	FORD EXPED.	--
	2009	2014	FORD F-150	--
	2009	2017	LINC NAVIGATOR	--
31069	2014	2018	CHEV SILVERADO 1500	--
	2014	2018	GMC SIERRA 1500	--
31070	2015	2018	FORD F-150 KING RANCH	--
	2015	2018	FORD F-150 LARIAT	--
	2016	2018	FORD F-150 LTD	--
	2015	2018	FORD F-150 PLATINUM	--
	2016	2018	FORD F-150 SSV	--
	2015	2018	FORD F-150 XL	--
	2015	2018	FORD F-150 XLT	--
31071	2015	2018	CHEV SILVERADO 2500 HD	--
	2015	2018	CHEV SILVERADO 3500 HD	--
	2015	2018	GMC SIERRA 2500 HD	--
	2015	2018	GMC SIERRA 3500 HD	--
31073	2015	2017	CHEV TAHOE LS	--
	2015	2017	CHEV TAHOE LT	--
	2015	2016	CHEV TAHOE LTZ	--
	2017	2017	CHEV TAHOE PREMIER	--
	2015	2017	CHEV SUBURBAN	--
	2015	2017	GMC YUKON	--
	2015	2017	GMC YUKON XL	--
31074	2015	2017	CHEV COLORADO	--
	2015	2017	GMC CANYON	--
31075	2016	2017	TOYO TACOMA	--
31076	2014	2017	TOYO 4RUNNER SR5	--
	2016	2016	TOYO 4RUNNER TRAIL	--
	2017	2017	TOYO 4RUNNER TRD OFF-ROAD	--
31077	2016	2017	NISSAN TITAN XD	--
31078	2017	2018	FORD F-250 SD	--
	2017	2017	FORD F-350 SD	--
	2017	2017	FORD F-450 SD	--
31080	2000	2004	DODGE DAKOTA 4WD	--
	2000	2003	DODGE DURANGO 4WD	--
31081	2017	2017	NISSAN ARMADA	--
31082	2017	2017	HONDA RIDGELINE	--
31084	1984	2001	JEEP CHEROKEE	--
	1986	1992	JEEP COMANCHE	--
	1984	1990	JEEP WAGONEER	--

Part#	Yrs From	Yrs To	Make / Model / Style	Repl By
31097	1998	1999	DODGE DAKOTA	--
	1998	1999	DODGE DURANGO	--
31108	2001	2006	CHEV/GMC 2500 SUBURBAN, 1500/2500 YUKON XL	--
	2000	2007	CHEV/GMC SILVERADO/SIERRA 2500HD/3500 CLASSIC BODY	--
31109	2007	2010	CHEV/GMC SILVERADO/SIERRA 2500HD/3500 NEW BODY	--
31114	1999	2007	FORD F-250/350 SD	--
	2000	2005	FORD EXCURSION	--
	1999	2007	FORD F-350 SD CAB & CHASSIS	--
	1999	2007	FORD F-450 SD CAB & CHASSIS	--
	1999	2007	FORD F-550 SD CAB & CHASSIS	--
31180	2000	2006	TOYO SEQUOIA	--
	2000	2006	TOYO TUNDRA	--
31198	2008	2017	TOYO SEQUOIA	--
	2007	2017	TOYO TUNDRA	--
31199	2004	2008	NISSAN TITAN	--
31221	2004	2012	CHEV/GMC COLORADO/CANYON	--
31228	2005	2007	DODGE DAKOTA	--
31230	2008	2011	DODGE DAKOTA	--
	2008	2010	MITSU RAIDER	--
31241	2005	2017	NISSAN FRONTIER	--
	2005	2012	NISSAN PATHFINDER	--
	2009	2013	SUZUKI EQUATOR	--
31270	2006	2010	HUMMER H3	--
31297	2004	2009	DODGE DURANGO	--
	2006	2009	CHRYSLER ASPEN	--
31302	2000	2006	CAD ESCALADE	--
	2002	2006	CHEV/GMC AVALANCHE	--
	2000	2006	CHEV/GMC SUBURBAN, TAHOE, & 1500 YUKON	--
	1999	2007	CHEV/GMC SILVERADO/SIERRA CLASSIC BODY	--
31310	1992	1997	FORD F-250/F-350	--
31311	1992	1996	FORD F-250 & F-350	--
	1997	1997	FORD F-250HD 2WD & F-350 DSL	--
31313	2005	2015	TOYO TACOMA	--
31320	2002	2008	DODGE RAM 1500, EXCL MEGA CAB	--
31321	2006	2007	DODGE RAM 1500 SPORT	--
31322	2007	2013	CHEV/GMC SILVERADO/SIERRA 1500 NEW BODY	--
31352	2003	2006	FORD EXPED.	--
	2004	2008	FORD F-150, EXCL '04 HERITAGE	--
	2004	2008	LINC MARK LT PICKUP	--
31367	2010	2013	TOYO 4RUNNER TRAIL ED	--
	2007	2009	TOYO 4RUNNER	--
	2007	2014	TOYO FJ CRUISE	--
31368	2007	2008	FORD EXPED.	--
	2007	2008	LINC NAVIGATOR	--
31374	2009	2010	DODGE RAM 1500 4WD ONLY	--
	2011	2018	RAM 1500 4WD ONLY	--
31407	2001	2006	FORD EXPLORER SPORT TRAC	--
31408	1987	2006	JEEP WRANGLER	--
31432	2007	2017	JEEP WRANGLER EXCL HARD ROCK BUMPER	--
	2007	2017	JEEP WRANGLER EXCL 75TH ANNY BUMPER	--
31433	2007	2017	JEEP WRANGLER W HARD ROCK BUMPER ONLY	--
31514	2005	2015	NISSAN XTERRA	--
31540	2002	2006	FORD EXPLORER	--
31545	2007	2010	FORD EXPLORER	--
	2007	2010	FORD EXPLORER SPORT TRAC	--
	2007	2010	MERCURY MOUNTAINEER	--
31604	2002	2002	DODGE RAM 2500/3500	--
	1994	1996	DODGE RAM PICKUPS	--
	1994	1996	DODGE RAM 1500	--
	1997	2001	DODGE RAM 1500 LARAMIE	--
	1997	1998	DODGE RAM 1500 SS/T 5.9L	--
	1997	2001	DODGE RAM 1500 ST	--
	1997	2001	DODGE RAM 1500 WS	--
	2002	2002	DODGE RAM 1500	--
31650	2005	2010	FORD ESCAPE	--
	2005	2011	MAZDA TRIBUTE	--
	2005	2010	MERCURY MARINER	--
33055	1991	2007	FORD ECONO VAN (E-SERIES)	--
33328	2003	2008	HONDA PILOT	--
	2005	2014	HONDA RIDGELINE	--

ALL PRODUCTS LISTED NUMERICALLY

Part#	Description	Page#
16000	LOOP,SAFETY CHAIN,5TH WHEEL	312
16017	FORD OEM 5TH WHEEL LEGS	299
16020	ROLLER,FORD PUCK	300
16021	OEM 5TH WHEEL LEG KIT-CHRYSLER	299
16022	RAM OE ROLLER MOUNT	300
16023	GM OE ROLLER ADAPTER	300
16025	GM OEM 5TH WHEEL LEGS	299
16026	NISSAN TITAN XD 5TH WHEEL	299
16031	KIT, 16017 & 16515	299
16033	KIT, 16017 & 16520	299
16034	KIT, 16017 & 16540	299
16035	KIT, 16017 & 16530	299
16036	KIT, 16017 & 16580	299
16037	KIT, 16017 & 16545	299
16039	KIT, 16017 & 16565	299
16041	KIT, 16021 & 16515	299
16043	KIT, 16021 & 16520	299
16044	KIT, 16021 & 16540	299
16045	KIT, 16021 & 16530	299
16046	KIT, 16021 & 16580	299
16047	KIT, 16021 & 16545	299
16049	KIT, 16021 & 16565	299
16055	RAIL MOUNTED GOOSENECK HITCH	290
16061	KIT, 16025 & 16515	299
16063	KIT, 16025 & 16520	299
16064	KIT, 16025 & 16540	299
16065	KIT, 16025 & 16530	299
16066	KIT, 16025 & 16580	299
16067	KIT, 16025 & 16545	299
16069	KIT, 16025 & 16565	299
16071	KIT, 16026 & 16515	299
16073	KIT, 16026 & 16520	299
16074	KIT, 16026 & 16540	299
16075	KIT, 16026 & 16530	299
16085	RAIL MOUNTED GOOSENECK HITCH	290
16100	5TH WHEEL MOUNTING RAIL KIT	302
16101	INSTALLATION HARDWARE KIT FOR	302
16103	BOLT KIT,FIFTH WHEEL, 8PC	302
16103010	BOLT KIT,FIFTH WHEEL, 80PC	302
16104	5TH WHEEL RAIL KIT,NO HARDWARE	302
16111	UNIVERSAL RAIL HARDWARE KIT	302
16115	16K 5TH WHEEL UNIT	310
16116	KIT, 16115 & 16200	310
16120	A16 5TH WHEEL	307
16121	A16 5TH WHEEL WITH BASE RAILS	307
16130	CURT Q20 20K 5TH WHEEL HITCH	309
16131	KIT, 16130 & 16200	309
16140	A20 5TH WHEEL HITCH	307
16141	A20 5TH WHEEL WITH BASE RAILS	307
16150	RAILS,5TH WHL,W/CNTR HOLES,CB	302
16180	A25 5TH WHEEL HITCH	307
16181	A25 5TH WHEEL WITH BASE RAILS*	307
16200	CARBIDE BLACK 5TH WHEEL RAIL K	302
16204	CARBIDE 5TH WHEEL RAILS	302
16210	X5 ADAPTER PLATE	305
16220	X5 ADAPTER PLATE	305
16245	FIFTH WHEEL, Q24	309
16246	KIT,16245 & 16200	309
16265	FIFTH WHEEL, Q25	309
16266	KIT,16265 & 16200	309
16300	CUSTOM 5TH WHEEL INSTALL KIT	303
16301	CUSTOM 5TH WHEEL INSTALL KIT	303
16302	CUSTOM 5TH WHEEL INSTALL KIT	303
16303	CUSTOM 5TH WHEEL INSTALL KIT	303
16304	TUNDRA UNIVERSAL RAIL BOLT KIT	303
16306	DODGE 5TH WHEEL UNDERBED KIT	303
16310	X5 B & W ADAPTER PLATE	305
16400	GM 5TH WHL UNDERBED KIT	303
16411	CHEVY/GMC UNDERBED 5TH WHL KIT	303
16412	CHEVY/GMC UNDERBED 5TH WHL KIT	303
16418	CHEVY/GMC UNDERBED 5TH WHL KIT	303
16419	DODGE 5TH WHEEL UNDERBED KIT	303
16420	DODGE UNDERBED FIFTH WHEEL KIT	303

Part#	Description	Page#
16422	DODGE UNDERBED FIFTH WHEEL KIT	303
16424	FORD 5TH WHEEL UNDERBED KIT	303
16426	RAM UNDERBED FIFTH WHEEL KIT	303
16427	RAM UNDERBED FIFTH WHEEL KIT	303
16428	FORD SUPER DTY FIFTH WHEEL KIT	303
16437	FORD 5TH WHEEL UNDERBED KIT	303
16441	FORD F150 UNDERBED 5TH WHL KIT	303
16442	FORD F-150 5TH WHEEL KIT	303
16443	FORD UNDERBED 5TH WHEEL KIT	303
16444	RAM UNDERBED 5TH WHEEL KIT	303
16448	FORD SD UNDERBED 5TH WHEEL KIT	303
16465	TOYOTA TUNDRA UNDERBED 5TH WHL	303
16468	TOYOTA 5TH WHEEL UNDERBED KIT	303
16470	NISSAN TITAN FIFTH WHEEL KIT	303
16505	16115 E5 ADAPTER KIT	310
16515	16515 E5 FIFTH WHEEL HEAD ONLY	310
16516	KIT, 16515 & 16560	310
16520	A16 5TH WHEEL HEAD UNIT	307
16521	A16 5TH WHEEL WITH R16 ROLLER	307
16530	HEAD, FIFTH WHEEL, Q20	309
16536	KIT,16530 & 16550	309
16540	A20 5TH WHEEL HEAD UNIT	307
16541	A20 5TH WHEEL WITH R20 ROLLER	307
16545	HEAD,FIFTH WHEEL, Q24	309
16546	KIT,16545 & 16570	309
16550	ROLLER,FIFTH WHEEL, R20	301
16560	ROLLER,FIFTH WHEEL, R16	301
16565	HEAD,FIFTH WHEEL, Q25	309
16566	KIT,16565 & 16570	309
16570	ROLLER, FIFTH WHEEL, R24	301
16580	A25 5TH WHEEL HEAD UNIT	307
16616	KIT, 16515, 16560 & 16200	310
16621	A16 5TH WHEEL\R16 ROLLER\RAILS	307
16636	KIT,16530,16550 & 16200	309
16641	A20 5TH WHEEL\R20 ROLLER\RAILS	307
16646	KIT,16545,16570 & 16200	309
16666	KIT,16565,16570 & 16200	309
16667	KIT, 16023 & 16560 & 16515	301
16668	KIT, 16023 & 16560 & 16520	301
16669	KIT, 16023 & 16550 & 16540	301
16671	KIT, 16023 & 16550 & 16530	301
16674	KIT, 16020 & 16515	301
16675	KIT, 16020 & 16520	301
16676	KIT, 16020 & 16540	301
16677	KIT, 16020 & 16530	301
16678	KIT, 16020 & 16545	301
16684	KIT, 16022 & 16561	301
16685	KIT, 16022 & 16521	301
16686	KIT, 16022 & 16541	301
16687	KIT, 16022 & 16536	301
16688	KIT, 16022 & 16546	301
16721	10 IN 5TH WHEEL LUBE PLATE	312
16721025	LUBE PLATE, 5TH WHEEL, 25 PACK	312
16722	LUBE PLATE, 5TH WHEEL, 12 INCH	312
16900	SPACER KIT,5TH WHL TAB MT	312
16901	SPACER KIT,5TH WHL TAB MT,CLAM	312
16902	5TH WHEEL REPL PINS AND CLIPS	290
16904	16130 SERVICE KIT,LEGS (PAIR)	309
16906	16140 A20 LEG KIT	307
16907	5TH WHEEL LEG KIT *	307
16913	Q24 LEG KIT	309
16920	16120 - LEG KIT	307
16963	Q25 LEG KIT	309
16991	E16 WEDGE KIT	311
16992	Q16 WEDGE KIT	311
17000	600 TW ROUND BAR KIT 600 LBS M	323
17001	800 TW ROUND BAR KIT 800 LB MA	323
17002	1000 TW ROUND BAR KIT 1000 LB	323
17003	SNAP-UP BRACKET WD BARS CLAMP	325
17005	SNAP-UP BRACKET WD BAR BOLTON	325
17007	WD,ROUND BAR,1400 LB	323
17008	WD,HOOK-UP BRKT,SINGLE LP	325
17022	WD,ROUND BAR,1000 LB,KIT	323

Part#	Description	Page#
17050	600 TW ROUND BAR WD	322
17051	800 TW ROUND BAR WD	322
17052	1000 TW ROUND BAR WD	322
17057	1400 TW ROUND BAR WD	322
17062	1000 TW ROUND BAR WD W/SWAY	322
17063	1400 TW ROUND BAR WD W/SWAY	322
17071	600 TW REPLACEMENT ROUND BAR	322
17072	800 TW REPLACEMENT ROUND BAR	322
17073	1000 TW REPLACEMENT ROUND BAR	322
17074	1400 TW REPLACEMENT ROUND BAR	322
17075	WD REPLACEMENT HEAD	322
17076	BOLT KIT	322
17100	ADJ HITCH BAR 12 IN LENGTH	324
17101	WD,600# RND BAR REPL W/CHAIN	323
17102	ADJ HITCH BAR 14 IN LENGTH	324
17103	ADJ HITCH BAR 16 IN LENGTH	324
17107	ROUND BAR WD REPLACEMENT HEAD	323
17109	RETAINER PACKAGE	325
17111	SPRING BAR CHAIN & U-BOLT KIT	325
17112	LIFT HANDLE	325
17113	WD,800# RND BAR REPL W/CHAIN	323
17114	REPLACEMENT 1 IN RIVET	323
17115	WD,1000# RND BAR REPL W/CHAIN	323
17117	1400# SPRING BAR W/CHAIN	323
17120	ADJ HITCH BAR 12 IN X 5 625 IN	324
17121	ADJ HITCH BAR 14 IN X 6 IN WIT	324
17122	ADJ HITCH BAR 16 IN X 6 IN WIT	324
17123	ADJ HITCH BAR 9 IN X 7 IN WITH	324
17124	ADJ HITCH BAR 11 IN X 8 3/4 IN	324
17125	ADJ HITCH BAR 10 IN X 14 1/2 I	324
17128	2.5" WD 8 IN SHANK	324
17150	BOLT KIT FOR ROUND BAR WEIGHT	323
17200	SWAY CONTROL KIT	316
17201	SWAY CONTROL A-FRAME BALL	316
17208	(2)OPTIONAL SNAP UP BRACKETS	325
17222	WD,ROUND BAR,1400 LB,KIT	323
17300	WEIGHT DISTRIBUTION TRUNNION S	320
17301	WEIGHT DISTRIBUTION TRUNNION S	320
17302	WEIGHT DISTRIBUTION TRUNNION S	320
17303	WD,1000#LONG TBAR REPL W/CHAIN	320
17307	WEIGHT DISTRIBUTION HITCH HEAD	320
17308	WD,800#LONG TBAR REPL W/CHAIN	320
17309	WD,600#LONG TBAR REPL W/CHAIN	320
17312	WD ADJUSTMENT ROD KIT	320
17314	WD WASHER SERVICE KIT	320
17322	WD,TRUNNION,SHORT BAR,1K KIT	320
17330	WD,TRUNNION,SHORT BAR,600 LB	320
17331	WD,TRUNNION,SHORT BAR,800 LB	320
17332	WD,TRUNNION,SHORT BAR,1000 LB	320
17333	WD,TRUNNION,1500 LB	320
17334	WD,600#SHORT TBAR REPL W/CHAIN	320
17335	WD,800#SHORT TBAR REPL W/CHAIN	320
17336	WD,1000#SHORT TBAR REP W/CHAIN	320
17337	1500# SHORT SPRING BAR W/CHAIN	320
17340	WD,600# TRUNNION W/PINS	321
17341	WD,800# TRUNNION W/PINS	321
17342	WD,1000# TRUNNION W/PINS	321
17347	WD,1500# TRUNNION W/PINS	321
17350	BOLT KIT FOR TRUNNION BAR WEIG	320
17422	WD,TRUNNION,1500 LB KIT	320
17499	WD,800# W/INTEGRATED SWAY	319
17500	WD,1000# W/INTEGRATED SWAY	319
17501	WD 1500# W/INTEGRATED SWAY	319
17507	WD REPLACEMENT HEAD, 17500	319
17508	REPLACEMENT INT-WD BRACKET	319
17509	1500# REPLACEMENT HEAD	319
17512	TRU-TRACK TENSION BAR	319
17513	REPLACEMENT L-PINS & CLIPS	319
17515	REPLACEMENT BRACKET KIT, 8"	319
17516	REPLACEMENT BRACKET KIT, 10"	319
17536	1000# REPLACEMENT SPRING BAR	319
17537	1500# REPLACEMENT SPRING BAR	319
17550	BOLT KIT FOR INT-WD	319

Part#	Description	Page#
17554	BOLT KIT FOR INT-WD, 17501	319
18007	STRAP,REPLACEMENT, QTY 2	351
18008	BIKE RACK TOWABLE SHANK	353
18011	BOLT ON BIKE RACK 2 BIKE CARRI	354
18013	BIKE RACK, CLAMP-ON	354
18016	BIKE BEAM	354
18029	RACK, 2-BIKE, DUAL ARM	353
18030	RACK, 2-BIKE, DUAL ARM W/EXT	353
18031	BIKE RACK 2/4 W/TBL SHANK	353
18033	RACK, 3-BIKE, DUAL ARM	353
18034	RACK, 4-BIKE	353
18035	BIKE RACK 4 W/TBL SHANK	353
18050	STRAP, BIKE RACK	355
18063	RACK, 3-BIKE, TAPERED DUAL ARM	351
18064	RACK, 4-BIKE, TAPERED DUAL ARM	351
18065	RACK, 5-BIKE, TAPERED DUAL ARM	351
18085	BIKE RACK, 2-BIKE, TRAY STYLE	350
18087	BIKE RACK, 4-BIKE, TRAY STYLE	350
18090	LOCKING KNOBS TRAY STYLE RACK	355
18091	FAT TIRE BIKE RACK TRAYS	350
18100	CARRIER, CARGO, ALUMINUM	346
18101	CARRIER, CARGO, ATV	348
18108	CARGO CARRIER 2IN FIXED 60X20	346
18109	CARGO CARRIER FOLDING 60X20	346
18110	CARGO CARRIER, 48" X20" FIXED	346
18115	ROOF RACK, EXPANDABLE, 43.5X37X4	348
18117	ROOF RACK, EXTENSION, 43.5X20X4	348
18145	CARGO CARRIER, KNOCK DN, 48X20X6	347
18150	CARGO CARRIER BASKET FIXED SHA	347
18151	CARGO CARRIER BASKET FOLDING S	347
18152	CARGO CARRIER, 60X24 FIXED	347
18153	CARGO CARRIER, 60X24 FOLDING	347
18200	CARGO NET, ROOF RACK	349
18201	CARGO NET, EXTENDED ROOF RACK	349
18202	CARGO NET	349
18210	CARGO CARRIER BAG 18"	349
18211	CARGO CARRIER BAG 22"	349
18220	ROOF RACK BAG 38"	349
18221	ROOF RACK BAG 59"	349
19030	2 IN X 2 IN RECEIVER HITCH	21
19031	2 IN X 2 IN BUMPER HITCH	21
19745	ADJUSTABLE TOW BAR	232
19746	REPLACEMENT SAFETY PIN	232
19748	BUMPER BRACKET KIT	232
19749	TOW BAR BLACK VINYL COATED CHA	334
20001	WRENCH, BOX END, 1.125/1.50, 6 PT	220
20002	MIRROR	233
21100	REDUCER BUSHING 1 IN TO 3/4 IN	213
21101	REDUCER BUSHING 1 IN TO 3/4 IN	213
21200	REDUCER BUSHING 1 1/4 IN TO 1	213
21201	REDUCER BUSHING 1 1/4 IN TO 1	213
21300	REDUCER BUSHING 1 3/8 TO 1 1/4	213
21301	REDUCER BUSHING 1 3/8" - 1 1/4	213
21400	1/2 IN HITCH PIN WITH CLIP POL	227
21401	1/2 IN HITCH PIN WITH CLIP PAC	227
21403	1/2" GROOVED HITCH PIN & CLIP	227
21404	1/2" GROOVED PIN & CLIP PACKAGED	227
21410	1/2" PIN & CLIP, COATED GRIP	227
21411	1/2" PIN & CLIP, COATED GRIP	227
21500	5/8 IN HITCH PIN WITH CLIP POL	227
21501	5/8 IN HITCH PIN WITH CLIP PAC	227
21502	UNIVERSAL RECEIVER PIN & CLIP	227
21504	5/8" GROOVED HITCH PIN & CLIP	227
21505	5/8" GROOVED PIN & CLIP PACKAGED	227
21507	5/8" GROOVED PIN & CLIP, BULK	227
21510	5/8" PIN & CLIP, COATED GRIP	227
21511	5/8" PIN & CLIP, COATED GRIP	227
21541	HITCH PIN, CHR, 1/2" PIVOT LK	228
21551	5/8 IN CHROME SWIVEL HITCH PIN	228
21561	1/2 IN SWIVL HITCH PIN W/SLEEV	228
21578	5/8 IN HITCH PIN & CLIP BLACK	227
21579	5/8 IN HITCH PIN WITH CLIP BLA	227
21580	5/8" HITCH PIN FOR SUPER DUTY	227
21581	5/8" HITCH PIN SUPER DUTY PKG	227
21582	5/8" CD GROOVED PIN & CLIP	227
21583	5/8" CD GROOVED PIN & CLIP PACK	227
21600	CLIP FOR HITCH PIN, BULK	227

Part#	Description	Page#
21601	CLIP FOR HITCH PIN PKG	227
21602	HITCH PIN CLIP, 3 PACK	227
21728	PROTECTIVE RUBBER CAP 2 IN X 2	231
21800	PLASTIC HITCH BALL COVER	220
21801	PLASTIC HITCH BALL COVER/PKGD	220
21810	BALL COVER, 2 5/16" BLACK, BULK	220
21811	BALL COVER, 2 5/16" BLACK, PKG	220
21900	CHROME TUBE COVER	231
21901	CHROME TUBE COVER/PKGD	231
22100	2 IN X 2 IN TUBE COVER CHROME	231
22101	2 IN X 2 IN TUBE COVER CHROME	231
22110	2 IN X 2 IN TUBE COVER CHROME	231
22111	2 IN X 2 IN TUBE COVER CHROME	231
22170	2 IN X 2 IN TUBE COVER CHROME	231
22171	2 IN X 2 IN TUBE COVER CHROME	231
22178	BEARING PROTECTOR 2 QTY FITS 1	340
22180	2 IN X 2 IN TUBE COVER PLASTIC	231
22181	2 IN X 2 IN TUBE COVER PLASTIC	231
22198	BEARING PROTECTOR 2 QTY FITS 1	340
22200	HITCH BAG IN A CLEAR TUBE	213
22232	DUST COVER, BEARING 2.328	340
22244	BEARING PROT, 2.44" 2 PAK W/COV	340
22271	1 1/4" RECVR TUBE COVER	231
22272	COVER, RCVR TUBE, 2" CURT	231
22275	1 1/4" RECVR TUBE COVER PKG	231
22276	COVER, RCVR TUBE, 2" CURT, PKG	231
22277	COVER RECVR TUBE, 2-1/2" BULK	231
22278	COVER, RCVR TUBE, 2-1/2" PKGD	231
22315	ANTI-RATTLE FOR 1 1/4 IN HOLLO	226
22321	ANTI-RATTLE FOR 2 IN HOLLOW SH	226
22322	PROFINISHING PACK (BAGGED)	230
22401	TOW HOOK W/HARDWARE CHROME 100	210
22411	TOW HOOK W/HARDWARE 10000 LB B	210
22420	TOW HOOK CHROME 10000 GTW BULK	210
22430	TOW HOOK BLACK 10000 QTW BULK	210
22750	TUBE COVER 2 IN X 2 IN BLACK B	231
22751	STEEL TUBE COVER/PKGD	231
22800	CHOCKS, WHEEL, PAIR	340
23020	1/2 IN HITCH LOCK 15000 LB PAC	223
23021	5/8 IN HITCH LOCK 30000 LB PAC	223
23022	COUPLER LOCK BRASS 2 KEYS INCL	224
23024	1/2" HITCH PIN LOCK W/SLEEVE	223
23079	LOCK, COUPLER, ROLLED LIP	224
23081	LOCK, BLOCK HEAD *	224
23086	KEYED ALIKE LOCK COMBINATION	222
23088	KEYED ALIKE LOCK COMBINATION	222
23175	WHEEL CHOCK LK	226
23178	DUST COVER, BEARING, 1.78" 2 PAK	340
23179	TRAILER LOCK	224
23198	DUST COVER, BEARING, 1.98" 2 PAK	340
23209	3/4" WHEEL BEARING KIT	340
23210	1" WHEEL BEARING KIT	340
23211	1-1/16" WHEEL BEARING KIT	340
23232	DUST COVER, BEARING, 2.32" 2 PAK	340
23244	DUST COVER, BEARING, 2.44" 2 PAK	340
23255	LOCK, KING PIN, DUMBBELL STYLE	225
23256	LOCK, FIFTH WHEEL	225
23501	1/2" DOGBONE LOCK, CHROME	223
23502	5/8 IN RIGHT ANGLE LOCK	223
23503	ADJUSTABLE LOCK COUPLER	224
23504	5/8 IN RIGHT ANGLE LOCK, 2-1/2	223
23505	LOCK SET, HITCH & COUPLER	222
23506	1/2" W/ 5/8" SLEEVE, BLUE ALUM	223
23510	5/8 IN PUSH BUTTON 90 DEG LOCK	223
23515	5/8 IN DOGBONE LOCK CHROME	223
23516	5/8 IN DOGBONE LOCK SS	223
23517	5/8" DOGBONE LOCK, SS**	223
23518	5/8 IN DOGBONE LOCK BLACK	223
23519	5/8 IN DOGBONE LOCK, SS**	223
23520	7/8 IN SPAN COUPLER LOCK CHROME	224
23521	7/8 IN SPAN COUPLER LOCK BLACK	224
23522	2-1/2" SPAN COUPLER LOCK, CHR	224
23523	3-3/8" SPAN COUPLER LOCK, CHR	224
23526	5/8 DOGBONE WITH 7/8 SPAN LOCK	222
23527	5/8 IN DOGBONE LOCK WITH**	222
23528	5/8 IN DOGBONE LOCK CHROME**	223
23530	SILENT HITCH PIN	223

Part#	Description	Page#
23546	COUPLER LOCK, SOLID BRASS	224
23556	LOCK SET, KEYED ALIKE, ONE MOUNT	205
23562	SPARE TIRE LOCK PACKAGED	225
23581	HITCH PIN, 1/2" PIVOT LK, SS	228
23582	SS PIVOT LOCK HITCH PIN	228
23659	1 7/8 IN 2 IN AND 2 5/16 IN TR	224
23666	CABLE LOCK	225
25010	5/16 IN COUPLER SAFETY PIN	228
25011	5/16 IN COUPLER SAFETY PIN PAC	228
25012	K-8 1/4 IN COUPLER PIN WITH 12	228
25013	PIN, COUPLER, .25" W/12" CHAIN, PK	228
25034	5/16" SAFETY PIN W/CHAIN BULK	228
25035	5/16" SAFETY PIN W/CHAIN PACK	228
25080	COUPLER SAFETY PIN 1/4 IN DIA	228
25081	COUPLER SAFETY PIN 1/4 IN DIA	228
25094	REPAIR KIT, 1.875" COUPLER	328
25100	COUPLER, 2 X 3" STRAIGHT 5000#	328
25101	COUPLER, 2", A-FRAME, 5000#	328
25105	COUPLER, 1.875 X 2.5" 2000#	328
25128	COUPLER, 1.875 X 2" 2000#	328
25131	COUPLER, 1.875 X 3" 2000#	328
25135	COUPLER, 2 X 2.5" 3500#	328
25138	COUPLER, 2 X 3" 3500#	328
25153	COUPLER, 2 X 2" 3500#	328
25194	REPAIR KIT, 2" COUPLER	328
25200	COUPLER, 2 5/16", A-FRAME, 10000#	328
25210	COUPLER, 2", A-FRAME, 5000#	328
25217	COUPLER, 2", A-FRAME, 7000#	328
25227	COUPLER, 2 5/16", A-FRAME, 12500#	328
25294	REPAIR KIT, 2" COUPLER A-FRAME	328
25319	COUPLER, 2", ADJUST, 7000#, COLLAR	329
25328	COUPLER, 2 5/16", AJUSTBL, 15000#	329
25329	COUPLER, 2 5/16", AJUSTBL, 12500#	329
25330	COUPLER, 2 5/16", ADJ LT, 14000#	329
25388	BOLT KIT, ADJUST CPLR CHANNEL	329
28000	SAFETY PIN 3/8" W/ CHAIN, BULK	228
28001	SAFETY PIN 3/8" W/ CHAIN, PKGD	228
28100	JACK, BOLT ON SNAP RING 1000#	330
28101	JACK, BOLT SNAP RING 1000# PKGD	330
28112	JACK, BOLT ON SWIVEL 1200#	330
28113	JACK, BOLT ON SWIVEL 1200# PKGD	330
28115	JACK, BOLT ON SWIVEL 1500#	330
28116	JACK, BOLT ON SWIVEL 1500# PKGD	330
28155	JACK, BOLT, SWIVEL, 2 WHEEL	330
28156	JACK, BOLT, SWIVEL, 2 WHEEL PKGD	330
28200	JACK, A FRAME TOP WIND 2000#	330
28202	JACK, A FRAME TOP WIND 2K TL	330
28203	JACK, A FRAME TOP WIND 2K TL PKG	330
28204	JACK, A FRAME SIDE WIND 2000#	330
28250	JACK, A FRAME TOP WIND 5000#	330
28255	JACK, AFRAME TOPWIND 5K BLK HDL	330
28270	FOOT, JACK WITH HARDWARE	332
28271	FOOT, JACK WITH HARDWARE, PKGD	332
28272	FOOT, JACK 1.7", ZINC	332
28273	FOOT, JACK 1.7", ZINC, PKG	332
28274	FOOT, JACK 8.5", ZINC,	332
28275	FOOT, JACK 8.5", ZINC, PKG	332
28276	WHEEL, JACK CASTER, 1200#	332
28277	WHEEL, JACK CASTER, 1200#, PKG	332
28278	PIN, SAFETY FOR JACK FOOT	332
28279	PIN, SAFETY FOR JACK FOOT, PKG	332
28300	JACK, WELD, TOP WIND, 2K, 10"	331
28301	JACK, WELD, TOP WIND, 2K, 10" PKG	331
28302	JACK, WELD ON, SIDE WIND, 2000#	331
28304	JACK, WELD, TOP WIND, 2K, 15"	331
28305	JACK, WELD, TOP WIND, 2K, 15", PKG	331
28306	JACK, WELD ON, 2000 LB, SIDE WIND	331
28320	JACK, PIPE MNT, TOP WIND, 2K 10"	331
28321	JACK, PIPE MNT, SIDE WIND, 2000#,	331
28322	JACK, PIPE MNT, TOP WIND, 2000#,	331
28323	JACK, PIPE MNT, TOP WIND, 2000#, PK	331
28324	JACK, PIPE MNT, SIDE WIND, 2000#	331
28350	JACK, PIPE MNT, TOP WIND, 5K, 10"	331
28351	JACK, PIPE MNT, TOP WIND, 5K, 10" PK	331
28354	JACK, PIPE MNT, SIDE WIND, 5K, 10"	331
28356	JACK, PIPE MNT, TOP WIND, 5K 15"	331
28358	JACK, PIPE MNT, SIDE WIND, 5K, 15"	331

Part#	Description	Page#
28359	JACK, 5000 LB., SQ., WELD ON	331
28512	JACK, HD SQUARE 10K/12K ASSY	331
28570	JACK,HD SQUARE TOP WIND 7K/8K	331
28575	JACK,HD SQUARE SIDE WIND 7K/8K	331
28910	PART, JACK MARINE MNT BRKT	332
28911	PART, JACK MNT BARS & BOLTS	332
28912	PART,JACK CASTER WHEEL & BOLT	332
28913	PART,JACK FULL MARINE TOP HNDL	332
28914	PART,JACK GEAR KIT, MARINE	332
28921	PART,JACK TOP WIND HANDLE	332
28922	PART,JACK BEARING 2K/5K TW	332
28923	PART,JACK SIDE WIND HANDLE	332
28924	PART,JACK GEAR KIT 2K/5K SW	332
28925	PART,JACK CAP 2K SIDE WIND	332
28926	PART,JACK BLACK HANDLE KNOB	332
28927	PART,JACK BLACK HANDLE KNOB	332
28930	PART,JACK FEMALE PIPE, WELD	332
28931	PART,JACK MALE PIPE, WELD	332
28932	PART,JACK MALE PIPE, PIN TYPE	332
28934	PART,JACK 9/16" PIN W/ CHAIN	332
28935	PART,JACK 5/8" PIN W/ CHAIN	332
28937	PART,JACK 2K/5K FULL BLCK HNDL	332
28938	PART,JACK RND TB WELD MNT BRKT	332
28939	PART,JACK 2" SNAP RING	332
28940	PART,JACK 1/2" PLUNGER PIN	332
28950	PART,JACK GEAR KIT 12K	332
28951	PART,JACK FULL 12K HANDLE	332
28952	PART,JACK CAP 12K	332
28953	PART,JACK HANDLE CLIP	332
28954	PART,JACK 12K BEARING	332
28955	PART,JACK 12K PLUNGER PIN ASBL	332
28956	PART,JACK THREADED LIFTING NUT	332
28957	PART,JACK INNER PIPES W/ FOOT	332
28958	PART,JACK GEAR KIT 7K	332
28959	PART,JACK FULL 7K HANDLE SW	332
28960	PART,JACK 7K GEAR HNDL BUSHING	332
28961	PART,JACK CAP 7K	332
28962	PART,JACK 7K DROP LEG & FOOT	332
28963	PART,JACK 7K DROP LEG PIN	332
28964	PART,JACK FULL 7K BLCK HNDL TW	332
28965	PART,JACK 7K BEARING	332
29007	2 IN 20 FT NYLON WINCH STRAP *	339
29423	900 LB WINCH	339
29424	1200 LB WINCH	339
29425	1400 LB WINCH	339
29427	1700 LB WINCH	339
29428	1900 LB WINCH	339
29429	2100 LB WINCH	339
29433	900 LB WINCH W/15' STRAP	339
29435	1400 LB WINCH W/20' STRAP	339
29438	1900 LB WINCH W/20' STRAP	339
29450	15' WINCH STRAP	339
29451	20' WINCH STRAP	339
31001	STEP PAD	23
31002	LICENSE PLATE HOLDER	23
31005	WINCH MOUNT HANDLES	23
31006	SPARE TIRE MOUNT	23
31007	SKID SHIELD	23
31009	WINCH PLATE AND HANDLE ASSY	23
31010	WINCH MOUNT	23
40001	1 7/8 X 3/4 X 1 5/8 HITCH BALL	218
40002	1 7/8 X 1 X 2 1/8 HITCH BALL	218
40003	2 X 3/4 X 1 3/4 HITCH BALL	218
40004	2 X 1 X 2 1/8 HITCH BALL	218
40005	2 5/16 X 1 X 2 1/8 HITCH BALL	218
40006	2 5/16X1 1/4X2 5/8 HITCH BALL	218
40007	2-5/16 X 1 X 2-1/4 HITCH BALL	218
40008	BALL,HITCH,2.31X1.25,2.75,20K	218
40015	1 7/8 X 3/4 X 2 1/8 HITCH BALL	218
40016	1 7/8 X 3/4 X 3 HITCH BALL	218
40017	1 7/8 X 1 X 3 HITCH BALL	218
40018	2 X 3/4 X 2 1/8 HITCH BALL	218
40019	2 X 3/4 X 3 HITCH BALL	218
40020	2 X 1 X 3 HITCH BALL	218
40021	2 5/16 X 1 X 3 HITCH BALL	218
40022	2 5/16 X 1 1/4 X 3 HITCH BALL	218
40030	2-5/16 X 1-1/4 X 2-5/8 H. BALL	218

Part#	Description	Page#
40031	1 7/8 X1X2 3/16 X1 HITCH BALL	218
40032	1 7/8X1X2 1/8X2 HITCH BALL	218
40033	2 X 1 X 2 1/8 X 1 HITCH BALL	218
40034	2X1X2 1/8X2 HITCH BALL	218
40035	2 5/16X1 1/4X2 5/8 HITCH BALL	218
40036	2 5/16X1 1/4X2 5/8 HITCH BALL	218
40037	2 X 1 X 2 1/8 HITCH BALL	218
40038	2 X 1 X 2 1/4 HITCH BALL	218
40039	2 5/16 X 1 X 2 1/4 HITCH BALL	218
40042	2 5/16X1X2 1/4 HITCH BALL	218
40050	1 7/8X3/4 X2 1/8 HITCH BALL	218
40051	1 7/8X1X2 1/8 HITCH BALL	218
40052	2X3/4X2 1/8 HITCH BALL	218
40053	2 X 1 X 2 1/8 HITCH BALL	218
40054	2 5/16X1X2 1/8 HITCH BALL	218
40061	1 7/8 X 3/4 X 1 5/8 HITCH BALL	218
40062	1 7/8 X 1 X 2 1/8 HITCH BALL	218
40063	1 7/8X3/4X2 1/8 HITCH BALL	218
40064	2 X 3/4 X 1 3/4 HITCH BALL	218
40065	2 X 3/4 X 2 1/8 HITCH BALL	218
40066	2 X 1 X 2 1/8 HITCH BALL	218
40067	2 5/16 X 1 X 2 1/8 HITCH BALL	218
40068	2 5/16X1 1/4X2 5/8 HITCH BALL	218
40069	BALL,HITCH 2X1.25X2.625.PKG	218
40071	1 7/8 X 3/4 X 3 HITCH BALL	218
40072	1 7/8 X 1 X 3 HITCH BALL	218
40073	2 X 3/4 X 3 HITCH BALL	218
40074	2 X 1 X 3 HITCH BALL	218
40075	2 5/16 X 1 X 3 HITCH BALL	218
40076	2 5/16 X 1 1/4 X 3 HITCH BALL	218
40080	1 7/8X3/4X2 1/8 HITCH BALL	218
40081	1 7/8X1X2 1/8 HITCH BALL	218
40082	2X3/4X2 1/8 HITCH BALL	218
40083	2X1X2 1/8 HITCH BALL	218
40084	2 5/16X1X2 1/8 HITCH BALL	218
40085	2-5/16 X 1-1/4 X 2-3/4 RAW BAL	218
40086	2-5/16 X 1"RISE X1-1/4 X 2-5/8	218
40087	2 5/16 X 1 1/4 RAW HITCH BALL	218
40088	2 5/16 X 2 X 3 1/2 HITCH BALL	218
40089	3 X 2 X 3 1/4 HITCH BALL	218
40090	2 X 1 1/4 X 2 5/8 HITCH BALL	218
40093	SWAY CONTROL HITCH BALL	220
40094	2 5/16 GOOSE NECK WELD ON BALL	221
40103	PKG 3/4 IN REPLACEMENT NUT & W	220
40104	PKG 1 IN REPLACEMENT NUT & WAS	220
40105	PKG 1 1/4 IN REPLACEMENT NUT &	220
41200	2 IN REPLACEMENT BALL 6,000 LB	219
41340	3/4 IN REPLACEMENT SHANK, 3,50	219
41341	3/4 IN REPLACEMENT SHANK LONG,	219
41352	SHANK COVER FOR 3/4 IN SHANK,B	219
41353	SHANK COVER FOR 3/4 IN SHANK,	219
41354	SHANK COVER FOR 1 IN SHANK, BL	219
41355	SHANK COVER FOR 1 IN SHANK, RE	219
41780	1 7/8 IN REPLACEMENT BALL	219
41782	SWITCH BALL SET 3/4 IN SHANK W	219
41783	3/4 IN LONG SHANK W 1 7/8 IN	219
42100	1 INCH REPLACEMENT SHANK 6000	219
42178	1 IN SHANK WITH 1 7/8 IN & 2 I	219
42200	2 IN REPLACEMENT BALL 8,000 LB	219
42203	2 5/16 IN REPLACEMENT BALL 8,0	219
42225	SWITCH BALL SET 1 IN SHANK WIT	219
42280	SWITCH BALL SET 1 IN SHANK WIT	219
42780	1 7/8 IN REPLACEMENT BALL	219
45000	BALL MOUNT,4" R X 13.50	199
45001	BALL MOUNT,TRIBALL,HOLLOW SH	207
45002	BALL MOUNT,DBL BALL,HOLLOW SH	207
45003	BALL MOUNT,VER SHANK,3.50"R	209
45004	BALL MOUNT,5.75" D,W/D-RING	210
45005	BALL MOUNT,ATV,1.88" BALL W/T	211
45006	ADAPTER,ATV RECEIVER TUBE	211
45007	ADAPTER,BALL MNT TONGUE SLEEVE	213
45008	BALL MOUNT,ADJ DUAL BALL	206
45009	BALL MOUNT,ATV,2.00" BALL W/T	211
45011	BALL MOUNT, PACKAGED	200
45012	PACKAGED BALL MOUNT W/PIN AND	200
45013	ADAPTER,RECEIVER,VERTICAL	209
45014	BALL MOUNT 5 IN. RISE	199

Part#	Description	Page#
45015	BALL MOUNT 5 IN. RISE	199
45016	BALL MOUNT 3.25 DROP 2.63 RISE	199
45017	BALL MOUNT 2 3/4 IN DROP 2 1/8	199
45018	BALL MOUNT, 1 1/4" D, 2000/200	199
45019	BALL MOUNT, 1 1/4" D, 2000/200	199
45020	BALL MOUNT, 2 IN. 7500/750	200
45021	BALL MOUNT,3 1/8 R, 2000/200	199
45022	BALL MOUNT,3 3/4D, 2000/200	199
45023	BALL MOUNT, 4" R, 2000/200	199
45024	BALL MOUNT, 5" R, 2000/200	199
45025	BALL MOUNT, 5" R, 2000/200	199
45026	BALL MOUNT, 3.25" D, 2000/200	199
45027	BALL MOUNT, 3.25" D, 2000/200	199
45028	BALL MOUNT 6 IN DROP 5 1/16 IN	199
45029	BALL MOUNT,KIT 45005 + 45006	211
45031	PKG 2 IN X 3/4 IN X 8 1/4 IN B	200
45032	PACKAGED BALL MOUNT W/PIN AND	200
45033	D-3 W/ PIN, CLIP AND BAG	200
45035	D-532 MASTER PACK OF 3	208
45037	2 IN DROP LOADED BALL MOUNT W/	208
45038	BALL MOUNT,KIT 45006 + 45009	211
45041	BALL MOUNT,2"D,7500/750,LOADED	208
45042	BALL MOUNT,4"D,7500/750,LOADED	208
45047	2 IN X 3/4 IN X 10 1/4 IN RIGH	201
45048	RECEIVER EXTENSION 24"	212
45049	DUAL BALL & CLEVIS W/SHANK	206
45051	PKG 4 IN X 2 IN X 8 1/4 IN BAL	200
45052	PACKAGED BALL MOUNT W/PIN AND	200
45055	4 IN DROP LOADED BALL MOUNT W/	208
45057	MASTER PACK OF 3 D-554 BALLMOU	208
45059	SHANK,ADJ BALL & CLEVIS,45008	206
45067	4 IN X 2 IN X 10 1/4 IN RIGHT	201
45087	6 IN X 4 IN X 10 1/4 IN RIGHT	201
45131	2" DROP WELDED BM 5000	208
45134	2" DROP WELDED BM 7500	208
45136	BALL MOUNT,45131,MP 2	208
45139	BALL MOUNT,45134,MP 2	208
45141	2" X 2" STARTER KIT 2" DROP***	197
45142	2" X 2" STARTER KIT 4" DROP***	197
45147	1-1/4" X 1-1/4" STARTER KIT	197
45148	1 1/4" X 1 1/4" STARTER KIT***	197
45151	4" DROP WELDED BM 5000	208
45152	2" RISE WELDED BM 5000	208
45154	4" DROP WELDED BM 7500	208
45155	2" RISE WELDED BM 7500	208
45156	BALL MOUNT,45151,MP 2	208
45158	BALL MOUNT,45154,MP 2	208
45220	2 IN DROP W/8 1/4 IN & 10 1/4	201
45230	4 IN DROP W/8 1/4 IN & 10 1/4	201
45240	6 IN DROP W/8 1/4 IN & 10 1/4	201
45250	STRAIGHT BALL MOUNT 12 1/4 IN	200
45290	7500 GWT 2 IN DROP WITH 8 1/4	200
45293	2" DROP CHROME BALL MOUNT WITH	208
45295	2" DROP CHROME BALL MOUNT WITH	208
45296	7500 GWT - 4 IN DROP WITH 8 1/	200
45297	7500 GWT 6 IN DROP WITH 8 1/4	200
45310	BALL MOUNT 2" DROP HOLLOW *	202
45311	BALL MOUNT 4" DROP HOLLOW *	202
45312	BALL MOUNT 2" DROP SOLID *	202
45313	BALL MOUNT 4" DROP SOLID *	202
45331	BALL MOUNT,FORGED,2"D,15K,LOAD	208
45332	BALL MOUNT,FORGED,4"D,15K,LOAD	208
45336	BALL MOUNT, 10000 LB, 6" DROP	202
45338	BALL MOUNT, 10000 LB, 8" DROP	202
45340	FORGED BALL MOUNT 17K, 2" DROP	203
45341	FORGED BALL MOUNT 17K, 4" DROP	203
45342	FORGED BALL MOUNT 17K, 6" DROP	203
45405	BALL MOUNT REDUCER 2 1/2	213
45408	REDUCER SLEEVE SET 3" TO 2"	213
45425	CLASS V 2.5" BALLMOUNT/3" DRO	202
45426	CL V BALL MT.5" DROP	202
45427	CLASS V 2.5 BALL MT. 8"DROP	202
45430	FORGED BALL MOUNT 21K, 4" DROP	203
45431	FORGED BALL MOUNT 21K, 6" DROP	203
45432	FORGED BALL MOUNT 21K, 8" DROP	203
45446	BALL MOUNT, 12000 LB, 6" DROP	202
45448	BALL MOUNT, 12000 LB, 8" DROP	202

Part#	Description	Page#
45456	FORGED BALL MOUNT 20K, 2" DROP	203
45458	FORGED BALL MOUNT 20K, 4" DROP	203
45500	HOOK,TOW,FORGED RCVR MNT,10K	210
45503	BALL MOUNT,1.0"D.,38R,3500	199
45507	VERTICAL MOUNT BALLMOUNT	209
45510	CLASS I BALLMOUNT	199
45518	1 1/4 IN DROP W/ 6 3/4 IN CLAS	199
45519	1 1/4 IN DROP W/ 9 3/4 IN CLAS	199
45520	12 IN CLASS I & II BALL MOUNT	199
45521	3 1/4 DROP W/ 7 1/8 IN BAR CLA	199
45522	3 1/8 IN RISE X 14 IN CLASS I/	199
45534	TOWING STARTER KIT, 2" DROP	197
45551	BALL MOUNT,EURO,.75"R,1.875"B	198
45552	BALL MOUNT,EURO,.75"R,2"B	198
45554	TOWING STARTER KIT, 4" DROP	197
45561	BALL MOUNT,EURO,3.13"R,1.875"B	198
45562	BALL MOUNT,EURO,3.25"R,2"B	198
45571	BALL MOUNT,EURO,2.63"R,1.88"B	198
45572	BALL MOUNT,EURO,2.63"R,2"B	198
45581	BALL MOUNT,EURO,3.25"D,1.88"B	198
45582	BALL MOUNT,EURO,3.25"D,2"B	198
45591	BALL MOUNT,EURO,3.13"R,1.88"B	198
45592	BALL MOUNT,EURO,3.13"R,2"B	198
45643	BALL MOUNT,REVERSE,1.88/2.00	207
45644	REVERSIBLE BALL MOUNT WITH 2 I	207
45650	TRIPLE TOW BAR 1 7/8 IN 2 IN 2	207
45655	TRIPLE TOW BAR 1 7/8 X 2 X 2 5	207
45660	DOUBLE TOW BAR 2 IN X 2 5/16 I	207
45665	DOUBLE TOW BAR 2 IN X 2 5/16 I	207
45675	TRIBALL W/HOOK 1-7/8X2X2-5/16	207
45770	ADAPTABLE HITCH EXTENDER 2 IN	212
45775	ADAPTABLE HITCH EXTENDER 2 IN	212
45780	ADAPTABLE HITCH EXTENDER 2 X 1	212
45785	RECEIVER TUBE ADAPTER	212
45789	RECEIVER TUBE EXTENSION	212
45790	ADAPTABLE HITCH EXTENDER 1 1/4	212
45791	ADAPTABLE HITCH EXTENDER 2 IN	212
45792	MULTI-USE RECEIVER EXTENDER	211
45794	ADAPTER,RECEIVER TUBE,VERTICAL	211
45795	ADAPTABLE HITCH EXTENDER 2 IN	212
45796	ADAPTABLE HITCH EXTENDER 2 IN	212
45799	ADJUSTABLE MULTI-BALL MOUNT	206
45800	BALL MOUNT,MB,ADJ,REPL. MOUNT	206
45802	REPL ADJ TUBE MNT, FOR 45799	206
45810	MULTI-USE BALLMOUNT	211
45812	ADJUSTABLE BALL MOUNT	206
45820	SWAY CONTROL BALLMOUNT	209
45821	CLEVIS PIN BALL MOUNT	209
45822	MOUNT,WELD ON SWAY CONTROL	316
45825	MOUNT,TOW HOOK,CHROME	210
45831	TOW HOOK MOUNT 2-1/2"	210
45832	TOW HOOK MOUNT 2"	210
45900	BALL MOUNT,FORGED,DUAL,2/2.313	204
45901	BALL MOUNT,FORGED,DUAL	204
45902	BALL MOUNT,FR,DL 2/2.313 X 2.5	204
45910	SHANK,BM,FORGED,REPL 45900	205
45911	SHANK,BM,ADJ,REPL 45901	205
45912	BALL,ADJ DUAL,REPL 45900	205
45915	ONE MOUNT PIN&CLIP REPL. KIT	205
45916	ANTI-RATTLE SET SCREW W/WRENCH	205
45917	SHANK,BM,FRG,REPL 45902 X 2.5	205
45919	PINTLE,COMBO,ADJUSTABLE,2.00	204
45920	PINTLE,COMBO,ADJUSTABLE,2.313	204
45922	PINTLE,COMBO,ADJ,2.313, 20K	204
45923	BALL,ADJ DUAL,REPL 45902	205
45925	ONE MNT PIN&CLIP RPL. KIT, 20K	205
48004	PINTLE,RCVR MNT,10 TON	216
48005	PINTLE,RCVR MNT,5 TON	216
48006	PINTLE,COMB,RCVR MNT,2.31 BALL	216
48007	PINTLE,COMB,RCVR MNT,2.00 BALL	216
48010	2.5" REC MOUNT PINTLE 20K ****	216
48012	2.5" REC MNT PINTLE COMBO 20K*	216
48180	1 7/8 IN BALL & PINTLE COMBINA	214
48190	2 IN BALL & PINTLE COMBINATION	214
48200	8 TON COMBO BALL & PINTLE - 2	214
48205	5 TON GTW - REGULAR PINTLE FOR	214
48210	10 TON GTW - REGULAR PINTLE FO	214

Part#	Description	Page#
48215	15 TON GTW - REGULAR PINTLE FO	214
48230	30 TON GTW - REGULAR PINTLE	214
48323	7 IN PLATE 8 1/2 IN SHANK PINT	215
48324	7 IN PLATE 10 1/2 IN SHANK PIN	215
48325	10 1/2" ADJUSTABLE PINTLE MT	215
48326	8 1/2" PINTLE MOUNT	215
48327	10 1/2" PINTLE MOUNT	215
48328	8 1/2" ADJUSTABLE PINTLE MOUNT	215
48329	2.5" ADJUSTABLE PINTLE MOUNT	215
48330	BOLT KIT FOR PINTLE MOUNT	215
48331	BOLT KIT FOR PINTLE MOUNT	214
48339	2.5" PINTLE MOUNT, 20K, 4 HOLE	215
48340	2.5" PINTLE MOUNT	215
48341	13 IN PLATE 12 1/2 IN SHANK	215
48342	13 IN PLATE 14 1/2 IN SHANK	215
48343	2" PINTLE MOUNT, 17K, 4 HOLE	215
48510	22000 GTW - ALLOY STEEL DRAWBA	217
48520	15000 GTW - ALLOY STEEL DRAWBA	217
48530	45000 GTW - ALLOY STEEL DRAWBA	217
48550	35000 GTW - ALLOY STEEL DRAWBA	216
48560	60000 GTW - FORGED DRAWBAR WIT	216
48600	12000 GTW - 3 IN ADJUSTABLE EY	217
48601	12000 GTW - 3 IN ADJ EYE BLACK	217
48610	3 POSITION CHANNEL	217
48620	E-62 BOLT KIT, FOR E-63 & E-64	217
48630	3 IN ID EYE KIT W/3 POS CHANNE	217
48631	3 IN ID EYE KIT W/3 POS CHANNE	217
48640	3 IN ID EYE KIT W/5 POS CHANNE	217
48650	5 POSITION CHANNEL	217
48660	12 TON FORGED 3 IN ID EYE ADJU	217
48810	1 7/8 IN REPLACEMENT BALL FOR	220
48820	2 IN REPLACEMENT BALL	220
48830	2 5/16 IN REPLACEMENT BALL	220
49060	6 IN RECEIVER TUBE 2 IN X 2 IN	229
49090	9 IN RECEIVER TUBE 2 IN X 2 IN	229
49120	12 IN RECEIVER TUBE 2 IN X 2 I	229
49180	18 IN RECEIVER TUBE 2 IN X 2 I	229
49240	24 IN RECEIVER TUBE 2 IN X 2 I	229
49360	36 IN RECEIVER TUBE 2 IN X 2 I	229
49480	48 IN RECEIVER TUBE	229
49506	6 IN RECEIVER TUBE 1 1/4 IN X	229
49510	2.5" RECEIVER TUBE 10" LONG	229
49512	12 IN RECEIVER TUBE 1 1/4 IN X	229
49524	24 IN RECEIVER TUBE 1 1/4 IN X	229
49529	10 IN SOLID STEEL HITCH BAR	229
49530	12 IN SOLID STEEL HITCH BAR	229
49531	14 IN SOLID STEEL HITCH BAR	229
49532	16 IN SOLID STEEL HITCH BAR	229
49533	18 IN SOLID STEEL HITCH BAR	229
49534	20 IN SOLID STEEL HITCH BAR	229
49535	22 IN SOLID STEEL HITCH BAR	229
49536	24 IN SOLID STEEL HITCH BAR	229
49537	8 IN SOLID STEEL HITCH BAR	229
49717	WELD ON HITCH BOX 5000 GTW RAW	229
49770	3 IN X 3 IN X 1 IN COLLAR	229
49950	10000 LB WELD-ON SAFETY CHAIN	229
51110	BRK CNTRLR,VENTURER,PKG	291
51114	KIT,REPLACE BRK HDWRE,VENTURER	291
51120	BRK CNTRLR,DISCOVERY,PKG	291
51122	BRK CNTRLR,DISCOVERY,BULK(6)	291
51124	KIT,REPLACE BRK HDWRE,DISCOVER	291
51130	BRK CNTRLR,REFLEX,PKG	291
51140	BRK CNTRLR,TRIFLEX,PKG	291
51142	BRK CNTRLR,TRIFLEX,BULK	291
51144	KIT,REPLACE BRK HDWRE, TRIFLEX	291
51160	BRAKE CONTROLLER - ASSURE	291
51170	BRAKE CONTROLLER -	291
51312	HARNESS WITH QUICK PLUG,BULK	241
51313	HARNESS WITH QUICK PLUG,PKG	241
51322	HARNESS WITH QUICK PLUG,BULK	241
51323	HARNESS WITH QUICK PLUG,PKG	241
51332	HARNESS WITH QUICK PLUG,BULK	241
51333	HARNESS WITH QUICK PLUG,PKG	241
51342	HARNESS WITH QUICK PLUG,BULK	241
51343	HARNESS WITH QUICK PLUG,PKG	241
51352	HARNESS WITH QUICK PLUG,BULK	241
51353	HARNESS WITH QUICK PLUG,PKG	241

Part#	Description	Page#
51362	HARNESS WITH QUICK PLUG,BULK	241
51363	HARNESS WITH QUICK PLUG,PKG	241
51372	HARNESS WITH QUICK PLUG,BULK	241
51373	HARNESS WITH QUICK PLUG,PKG	241
51382	HARNESS WITH QUICK PLUG,BULK	241
51383	HARNESS WITH QUICK PLUG,PKG	241
51392	HARNESS WITH QUICK PLUG,BULK	241
51393	HARNESS WITH QUICK PLUG,PKG	241
51422	HARNESS WITH QUICK PLUG,BULK	241
51423	HARNESS WITH QUICK PLUG,PKG	241
51432	HARNESS WITH QUICK PLUG,BULK	241
51433	HARNESS WITH QUICK PLUG,PKG	241
51436	HARN,BKCTRL,QP,FORD F-150,BULK	241
51437	HARN,BKCTRL,QP,FORD F-150,PKG	241
51438	HARN,BKCTRL,QP,DODGE RAM,BULK	241
51439	HARN,BKCTRL,QP,DODGE RAM,PKG	241
51442	HARN,BK CTRL,KIA BORREGO,PP,BULK	241
51443	HARN,BK CTRL,KIA BORREGO,PP,PK	241
51446	HARN,BK CTRL,JEEP GR CHER,QP,B	241
51447	HARN,BK CTRL,JEEP GR CHER,QP,P	241
51448	HARN,BKCTRL,QP,DODGE RAM,PKG	241
51451	HARN,BKCTRL,QP,SILVERADO 1500*	241
51452	HARN,BKCTRL,QP,SILVERADO,PKG	241
51453	HARN,BKCTRL,QP,RAM,PKG	241
51455	HARN,BKCTRL,QP,TOYOTA TUNDRA*	241
51456	HARN,BKCTRL,QP,TUNDRA,PKG	241
51457	HARN,BKCTRL,QP,DODGE RAM,BULK	241
51458	HARN,BKCTRL,QP,DODGE RAM,PKG	241
51459	HARN,BKCTRL,QP,JEEP,BULK *	241
51460	HARN,BKCTRL,QP,JEEP,PKG	241
51498	TEST BOX, 7 WAY FUNCTION	269
51500	KIT,BRK CNTRL WIRING,UNIVERSAL	240
51515	HARN,BK CTRL,QP W/PIGTAILS	240
51516	HARN,BK CTRL,QP W/PIGTAILS,PKG	240
51520	HARN,BRK CTRL,D-T TO CURT,PKG	240
51521	TEST BOX, BRAKE CONTROL	269
52010	NYLON BREAKAWAY SWITCH WITH SW	245
52011	NYLON BREAKAWAY SWITCH PACKAGD	245
52020	REPLACEMENT LANYARD WITH PULL	245
52022	CURT BATTERY BOX	245
52023	CURT 12V 5.4 AMP RECHARGABLE B	245
52025	CURT 12V BATTERY CHARGER	245
52026	CURT SOFTRAC II BREAKAWAY KIT	244
52027	CURT BATTERY CASE	245
52028	CURT SOFTRAC II BREAKAWAY SYS	244
52029	CURT BATTERY BOX	245
52030	CURT BATTERY BOX	245
52040	CURT SOFTRAC I BREAKAWAY KIT	244
52041	CURT SOFTRAC I BREAKAWAY KIT	244
52042	BREAKAWAY KIT,PUSH TO TEST,S/L	244
52044	BREAKAWAY KIT,PUSH TO TEST,T/L	244
52090	CURT BATTERY BOX	245
53200	TOWING LIGHTS, 20', KIT	268
53204	4-WAY FLAT MAGNETIC TOW LIGHT	268
53440	RED COMBINATION LIGHT, W/OUT L	268
53441	RED COMBINATION LIGHT, W/OUT L	268
53445	RED REAR REPLACEMENT LENS COMB	268
53452	RED SUBMERSIBLE COMBO LIGHT,RI	268
53453	RED SUBMERSIBLE COMBO LIGHT, W	268
53515	RED SIDE REPLACEMENT LIGHT COM	268
53540	STOP TAIL AND SIDE LIGHTS W WI	268
55151	WIRING KIT, T-CONN, 10 AMP	255
55152	WIRING KIT, T-CONN, 15 AMP	255
55177	3 WIRE TO 2 WIRE CONVERTER	254
55178	3 TO 2 CONVERTER PACKAGED	254
55179	4 FLAT 3 TO 2 CONVERTER 12 IN	254
55415	OEM 7-WAY CONNECTOR	248
55416	HD 7-WAY USCAR 75035 CONNECTOR	248
55664	US CAR TO 6 ROUND AND 4 FLAT	248
55774	US CAR TO 7 RV AND 4 FLAT	248
56000010	10' 7 WAY OEM EXT ASSY 10 PACK	250
56070010	7' 7-WAY OEM EXT ASSY 10 PACK	250
56080	EXTENSION,5TH WHEEL,7-WAY	251
56130	CONVERTER,BASIC,PACKAGED(SM)	254
56132	CONV,BASIC,MASTERPACK(30)(SM)	254
56146	CONVERTER,CP,PWRD,PACKAGED(SM)	254
56146030	56146 30 PACK	254

Part#	Description	Page#
56175	CONVERTER,CP,PACKAGED(SM)	254
56187	CONVERTER,BASIC,PWRD,PKGD(SM)	254
56190	CONVERTER,HD W/SMART BOARD	254
56195	CONVERTER,CP,LSS,PACKAGED	254
56196	CONVERTER,2-WIRE TO 3-WIRE,PKG	254
56229	7 PIN USCAR VEHICLE CONNECTOR	247
56236	CONVERTER,MULTI-FUNCTION,PKGD	254
56415	OEM 7-WAY TWIST-LOK CONNECTOR	248
56424	BOARD, CONVERTER 24 VOLT	254
56496	POTTED TAILLIGHT CONVERTER	254
56515	OEM RPL,5-FLAT TO USCAR	248
56601	7 WAY MOLDED TRLR END 6' BULK	251
56602	7 WAY MOLDED TRLR END 8' BULK	251
56603	7 WAY MOLDED TRLR END 10' BULK	251
56611	7 WAY COLD WEATHER 6' BULK	251
56612	7 WAY COLD WEATHER 8' BULK	251
56613	7 WAY COLD WEATHER 10' BULK	251
56621	7 WAY MOLDED TRLR END 6' PKG	251
56622	7 WAY MOLDED TRLR END 8' PKG	251
56623	7 WAY MOLDED TRLR END 10' PKG	251
57000	KIT, RELAY, NISSAN	271
57001	WIRE, 16-4, WT/BN/YL/GN, 25 FT	269
57003	VW 7-WAY ADAPTOR	259
57004	ADAPTOR,7 TO 4/5,LED	259
57005	ADAPTOR,7 TO 6,LED	259
57007	KIT,7-WAY EXT, ISOLATION	251
57040	7-POLE ROUND TO 4 FLAT ADAPTER	260
57041	7-POLE ROUND TO 4 FLAT ADAPTER	260
57100	SOCKET,MFUNC,7WBLD,4W,BUA,DODG	247
57101	SOCKET,MFUNC,7WBLD,4W,BUA,FDGM	247
57102	SOCKET,MFUNC,7WBLD,4W,BUA,UNIV	247
57183	4-WAY FLAT TO 6-WAY ROUND CAR	256
57184	4-WAY FLAT TO 7-WAY RV ROUND C	256
57185	4-WAY FLAT TO 7-WAY ROUND CAR	256
57186	4-FLAT TO 7-WAY W/BC WIRING KIT	256
57187	5-WAY FLAT TO 4-WAY FLAT 75136	256
57201	BRKT,MNT,7WAY,UNV,LG, 12 PK	267
57202	MOUNTING BRKT, LONG W/CLAMP PKG	267
57203	BRKT,MNT,7WAY,UNV,SHORT,12 PK	267
57204	MOUNTING BRKT,SHORT W/CLAMP PK	267
57205	BRKT,MNT,7WAY,HD,12 PACK	267
57206	BRKT,MNT,7WAY,HD,PKG	267
57207	BRKT,MNT,456 WAY RND,12 PACK	267
57208	BRKT,MNT,456 WAY RND,PKG	267
57220	I-420 4-FLAT 20' TRAILER END	261
57224	4 POLE ROUND TO 4 FLAT ADAPTER	257
57225	4 POLE ROUND TO 4 FLAT ADAPTER	257
57240	7-WAY RV ROUND TO 4-WAY FLAT,	260
57241	7-WAY RV ROUND TO 4-WAY FLAT,	260
57245	7 TO 4 W/LED DUST COVER	258
57250	7-WAY RV (FLAT CONNECTORS) TO	260
57251	7-WAY RV (FLAT CONNECTORS) TO	260
57255	7 TO 6 AUX W/LED DUST COVER	258
57260	7-WAY RV ROUND TO 6-WAY ROUND,	260
57261	7-WAY RV STYLE (FLAT CONNECTOR	260
57265	7 TO 6 BRAKE W/LED DUST COVER	258
57271	7-WAY TO 4-WAY 75065	259
57300	ADAPTER,USCAR GM/FORD TO DODGE	246
57404	4 FLAT TO 4 FLAT 1.25 IN DIAME	262
57405	4-FLAT TO 4-FLAT 1.25 DIAMETER	262
57406	4-FLAT TO 4-FLAT 1.25 IN DIAME	262
57444	4 WAY ROUND TO 4 WAY FLAT ADAP	257
57505	12 VOLT CIRCUIT TESTER 5 WAY F	262
57604	4-WAY FLAT TO BOTH 6-WAY ROUND	256
57620	6-WAY ROUND TO 4-WAY FLAT, BUL	258
57621	6-WAY ROUND TO 4-WAY FLAT, PKG	258
57624	4 WAY FLAT TO BOTH 6 WAY ROUND	256
57626	6 WAY ROUND TO 4 WAY FLAT WITH	256
57627	6 TO 4 W/LED DUST COVER	258
57660	7-WAY RV TO 6 ROUND ADAPTER	260
57661	7-WAY RV TO 6 ROUND ADAPTER PK	260
57667	6-WAY ROUND TO 7-WAY RV, PKG	258
57672	4 WAY FLAT TO BOTH 7 WAY ROUND	256
57674	4 WAY FLAT TO BOTH 7 WAY ROUND	256
57676	7 WAY ROUND TO 4 WAY FLAT WITH	256
57720	7 TO 6 ADPTR W/BKUP ALM(CPB)	260
57724	7 TO 4 ADPTR W/BKUP ALM	260

Part#	Description	Page#
57725	7 TO 5 ADPTR W/BKUP ALM	260
57726	7 TO 6 ADPTR W/BKUP ALM(CPA)	260
57727	7 TO 7 ADPTR W/BKUP ALM	260
58000	BRACKET,ELEC,7WAY/4FLAT 2.00"	266
58000010	BRACKET,ELEC,7WAY/4FLAT 2.00"	266
58001	BRACKET,ELEC,4FLAT 2.00"	266
58001010	BRACKET,ELEC,4FLAT 2.00"	266
58002	BRACKET,ELEC,4FLAT 1.25"	266
58002010	BRACKET,ELEC,4FLAT 1.25"	266
58003	BRACKET,ELEC,7WAY/4FLAT 2.50"	266
58020	2-FLAT LOOP 12 IN BULK	261
58021	2-FLAT LOOP 12 IN PACKAGED	261
58030	4 WAY FLAT 12 IN TRAILER BONDE	261
58031	4 WAY FLAT 12 IN TRAILER BONDE	261
58033	I-3 4-FLAT TRAILER END 12 IN K	261
58034	6 WAY SQUARE W/12" LOOP	264
58035	6 WAY SQUARE CAR END BULK PKGD	264
58037	6 WAY SQUARE TRLR END PKG	264
58040	4 WAY FLAT 60 IN CAR BONDED BU	261
58041	4 WAY FLAT 60 IN CAR BONDED PA	261
58044	I-4 4-FLAT CAR END 60 IN KIT P	261
58050	4 WAY BONDED 72 IN LOOP CAR &	261
58051	4-WAY BONDED 72 IN LOOP CAR &	261
58060	4 POLE DIE CAST CONNECTOR TRAI	262
58061	PKG-4-WAY DIE CAST	262
58070	4 POLE DIE CAST CONNECTOR CAR	262
58071	PKG-7-WAY DIE CAST	262
58080	6 POLE DIE CAST CONNECTOR, TRA	264
58081	6 POLE DIE CAST CONNECTOR, TRA	264
58082	6-POLE DIE CAST CONNECTOR WITH	264
58083	CONN,6-POLE DIECAST W/SPRG,PKG	264
58090	6 POLE DIE CAST CONNECTOR, CAR	264
58091	6 POLE DIE CAST CONNECTOR CAR	264
58092	I-8/I-9 6-POLE DIE CAST CONNEC	264
58093	I-8/I-9/I-21 6-POLE DIE CAST C	264
58120	6 POLE PL CONN, TRAILER END	264
58130	6-POLE CONNECTOR, CAR END	264
58140	7 POLE PLASTIC CONNECTOR, TRAI	265
58141	7 POLE PLASTIC CONNECTOR, TRAI	265
58145	HD 7-WAY TRAILER-SIDE 75040	265
58150	7 POLE PLASTIC CONNECTOR, CAR	265
58151	7-POLE PLASTIC CONNECTOR, CAR	265
58152	PKG I-14/I-15/I-51 7 POLE CONN	265
58155	HD 7-WAY RV-STYLE 75310	265
58160	7-POLE DIE-CAST CONNECTOR, TRA	265
58161	CONN,7-POLE DIECAST,PKG	265
58170	7-POLE DIE-CAST CONNECTOR, CAR	265
58180	7-POLE DIE CAST CONNECTOR TRAI	265
58181	CONN,7-POLE DIECAST W/SPRG,PKG	265
58190	7-POLE METAL CONNECTOR TRAILER	265
58200	4-FLAT CAP,CARSIDE	263
58201	4-FLAT CAP,CARSIDE,PKG	263
58202	COVER, 5-FLAT, CARSIDE	263
58203	COVER, 5-FLAT, CARSIDE, PKGD	263
58210	BRACKET FOR CONNECTOR I-7 I-9	267
58220	7-POLE METAL CONNECTOR CAR END	265
58222	BRACKET FOR CONNECTOR I-17	267
58230	BRACKET FOR CONNECTOR I-15 & I	267
58231	BRACKET FOR CONNECTOR I-15 & I	267
58240	TAIL LIGHT CONVERTER 3 TO 2 WI	254
58260	LED 4-FLAT TESTER	269
58261	LED 4-FLAT TESTER,PKG	269
58270	12V 7-WAY RV ROUND CIRCUIT TES	269
58271	12V 7-WAY RV ROUND CIRCUIT TES	269
58280	14-18 GAUGE WIRE CONN- 100 PK	270
58290	BLACK BRACKET FOR CONNECTOR I-	267
58291	PKG BLACK ZINC CONN BRACKET FO	267
58300	BRACKET,4-FLAT,BULK	267
58301	BRACKET,4-FLAT,PKG	267
58304	12 CAR END/12 TRAILER END	261
58305	48 CAR END/12 TRAILER END KIT	261
58310	FLASHES 1-4 32 CP TURN SIGNAL	271
58312	2-FLAT POWER ADAPTER TO CIG. L	257
58313	2-FLAT POWER ADAPTER TO CIG. L	257
58320	FLASHES 2-3 32 CP TURN SIGNAL	271
58340	15 AMP UNIVERSAL CIRCUIT BREAK	271
58344	12 CAR END/12 TRAILER END KIT	261

Part#	Description	Page#
58348	48 TRAILER END	261
58349	48 TRAILER END KIT	261
58350	20 AMP UNIVERSAL CIRCUIT BREAK	271
58355	48 CAR END/12 TRAILER END	261
58360	30 AMP UNIVERSAL CIRCUIT BREAK	271
58370	40 AMP UNIVERSAL CIRCUIT BREAK	271
58380	4-WAY BONDED 12 BONDED LOOP, C	261
58381	4-WAY BONDED 12 BONDED LOOP, C	261
58390	PULL WIRE 3/8 IN	230
58400	PULL WIRE 1/2 IN	230
58404	4 FLAT TO 4 FLAT 1.25 IN DIAME	262
58405	4-FLAT TO 4-FLAT 1.25 IN DIAME	262
58406	4-FLAT TO 4-FLAT 1.25 IN DIAME	262
58410	PULL WIRE 7/16 IN	230
58414	4 WAY ROUND TO 4 WAY FLAT ADAP	257
58417	7 WAY RV SOCKET WITH MOUNTING	265
58430	PULL WIRE 5/8 IN	230
58440	FUSE,10 AMP ATC,BULK 100 PACK	271
58450	FUSE,15 AMP ATC,BULK 100 PACK	271
58460	FUSE,20 AMP ATC,BULK 100 PACK	271
58470	HOLDER, IN-LINE FUSE, BULK 12	271
58480	RELAY, BULK 12 PACK	271
58510	BRACKET FOR I-15/I-20 14 (BLAC	267
58520	BRACKET,U.S. CAR 7 WAY RV PLUG	267
58530	5-FLAT CAR END 60 IN BULK	263
58531	5-FLAT CAR END 60 IN PACK	263
58540	5-FLAT TRAILER END 48 IN BULK	263
58541	5-FLAT TRAILER END 48 IN PACKA	263
58550	5-FLAT LOOP 72 IN BULK	263
58551	5-FLAT LOOP 72 IN PACKAGED	263
58650	12 VOLT CIRCUIT TESTER 6 WAY R	269
58671	I-6/I-7, 4 POLE DIE CAST CONNE	262
58677	I-6/I-7/I-21 PKG.	262
58750	DUST COVER TRAILER SIDE	263
58761	DUST COVER SET	263
58823	1/4 IN CONVOLUTED SLIT LOOM PE	271
58900	RV HARNESS, CHEVY EQUINOX	252
58901	RV HARNESS, HONDA CRV	252
58902	RV HARNESS, JEEP WRANGLER	252
58903	RV HARNESS, JEEP WRANGLER	252
58904	RV HARNESS, HONDA CRV	252
58905	RV HARNESS, FORD FOCUS HATCH	252
58906	RV HARNESS, DODGE RAM 1500	252
58907	RV HARNESS, JEEP GRD CHEROKEE	252
58908	RV HARNESS, BUICK ENCLAVE	252
58909	RV HARNESS, JEEP CHEROKEE	252
58910	RV HARNESS, CHEVY COLORADO	252
58911	RV HARNESS, FIAT 500R	252
58912	RV HARNESS, FORD F-150	252
58913	RV HARNESS, TOYOTA RAV4	252
58914	RV HARNESS, FORD EDGE	252
58915	RV HARNESS, JEEP GRD CHEROKEE	252
58916	RV HARNESS, RAM 1500	252
58917	RV HARNESS, JEEP LIBERTY	252
58918	RV HARNESS, 4 FLAT ADD-ON	252
58919	RV HARNESS, NPWR CONVER ADD-ON	252
58920	RV HARNESS, PWR CONVER ADD-ON	252
58921	RV HARNESS, GMC ACADIA	252
58922	RV HARNESS, CHEVY TRAVERSE	252
58923	RV HARNESS, CHEVY 1500	252
58924	RV HARNESS, CHEVY AVALANCHE	252
58925	RV HARNESS, CHEVY TRAILBLAZER	252
58926	RV HARNESS, CHEVY COLORADO	252
58927	RV HARNESS, CADILLAC ESCALADE	252
58928	RV HARNESS, SATURN VUE	252
58929	RV HARNESS, CHEVY HHR	252
58930	RV HARNESS, LINCOLN MKX	252
58931	RV HARNESS, CHEVY COBALT	252
58932	RV HARNESS, BUICK ENCLAVE	252
58933	RV HARNESS, SATURN VUE	252
58934	RV HARNESS, CHEVY MALIBU	252
58935	RV HARNESS, CHEVY CRUZE	252
58936	RV HARNESS, CHEVY SONIC	252
58937	RV HARNESS, DODGE NITRO	252
58938	RV HARNESS, JEEP COMPASS	252
58939	RV HARNESS, JEEP GRD CHEROKEE	252
58940	RV HARNESS, JEEP GRD CHEROKEE	252

Part#	Description	Page#
58941	RV HARNESS, FORD FLEX	252
58942	RV HARNESS, FORD FUSION	252
58943	RV HARNESS, FORD ESCAPE	252
58944	RV HARNESS, FORD FOCUS	252
58945	RV HARNESS, FORD FUSION	252
58946	RV HARNESS, FORD FIESTA	252
58947	RV HARNESS, HONDA ELEMENT	252
58948	RV HARNESS, HONDA FIT	252
58949	RV HARNESS, HONDA CRV	252
58950	RV HARNESS, SUZUKI GRND VITARA	252
58952	RV HARNESS, FORD EDGE	252
59146	CONVERTER, CP, PWR KIT, PKGD(SM)	254
59187	CONVERTER, BASIC, PWRKIT, PKD(SM)	254
59190	CONVERTER, HD, PWRKIT, SMRT BRD	254
59236	CONVERTER, MULTI-FUNCTION, PKGD*	254
59421	22-18 G BUTT CONNECTORS 100 PE	270
59422	16-14 G BUTT CONNECTORS - 100	270
59423	12-10 G BUTT CONNECTORS - 100	270
59432	16-14 G MALE QUICK CONNECTOR -	270
59433	12-10 G MALE QUICK CONNECTOR -	270
59496	POTTED CONVERTER W/ WIRE KIT	254
59521	16-14 G 10 RING TERM - 100 PER	270
59522	16-14 G 1/4 IN RING TERM 100 P	270
59523	16-14 G 3/8 IN RING TERM 100 P	270
59525	16-14 G 5/16 IN RING TERM 100	270
59531	12-10 G 10 RING TERM 100 PER B	270
59534	12-10 G 1/4 IN RING TERM 100 P	270
59538	12-10 G 3/8 IN RING TERM 100 P	270
59556	12-10 G 5/16 IN RING TERM 100	270
59592	16-14 G FEMALE QUICK CONNECTOR	270
59593	12-10 G FEMALE QUICK CONNECTOR	270
59611	22-18 G SPADE TERMINALS - 100	270
59621	16-14 G SPADE TERMINALS - 100	270
59631	12-10 G SPADE TERMINALS - 100	270
59728	7 1/4 IN NYLON WIRE TIES 100 P	271
59732	14 1/4 IN NYLON WIRE TIES 100	271
59740	3/4 IN X 60 FT 10 PACK ELECTR	271
59824	3/8 IN CONVOLUTED SLIT LOOM PE	271
59825	3/8 X 25 IN SLIT LOOM PACKAGED	271
59826	1/2 IN BLACK CONVOLUTED SLIT L	271
59827	1/2 X 25 IN SLIT LOOM PACKAGED	271
59828	3/8 IN ID NYLON LOOM/PACKS 25	271
59901	WIRE NUTS - 100 PER BAG	270
59905	12-10 GAUGE QUICK SPLICES 100	270
59906	14-18 GAUGE QUICK SPLICES 100	270
59956	18-14 GAUGE TAP CONNECTOR 100	270
60601	60601 OE GOOSEBALL	277
60602	ROUND SHANK BALL EXTENSION	282
60603	ROUND SHANK HIGH RISE BALL	282
60604	CHEV/GMC 2500/3500 INSTALL KIT	284
60606	GOOSENECK INSTALL KIT	282
60607	DOUBLE LOCK GOOSENECK W/NOTCH	282
60611	DOUBLE LOCK EZR GOOSENECK	279
60614	RAM 2500 GOOSENECK HITCH	280
60615	CHEVY 1500 GOOSENECK CENTER	282
60616	600 SERIES REPLACEMENT BALL	282
60617	60617 RAM SAFETY CHAIN LOOPS	277
60618	60618 RAM SAFETY CHAIN KIT	277
60619	DOUBLE LOCK EZR GOOSENECK	279
60620	NISSAN TITAN GOOSENECK CENTER	282
60624	GM GOOSENECK SUB KIT	279
60625	TOYOTA TUNDRA GOOSENECK HITCH	282
60626	RAM 3500 GOOSENECK HITCH	280
60629	60629 OE GOOSEBALL	277
60630	QUICKGOOSE II	286
60631	GOOSENECK INSTALL KIT 1988-200	287
60632	NEW BODY CHEVY SUBKIT	284
60635	GOOSENECK INSTALL KIT 1994-200	284
60636	GOOSENECK INSTALL KIT OLD BODY	284
60637	GOOSENECK INSTALL KIT 1997-200	284
60640	QUICKGOOSE II	286
60641	GOOSENECK INSTALL KIT NEW BODY	284
60644	SUB-KIT, 600 SERIES, FORD SD	285
60645	SUB-KIT, FORD SD	279
60647	SUB-KIT, EZR, FORD SD	279
60648	SUB-KIT, EZR, CHEV HD	279
60649	SUB-KIT, FORD F-150	284

Part#	Description	Page#
60652	GOOSENECK INSTALL KIT, CHEVY	284
60657	DODGE RAM INSTALL KIT	284
60658	RAM 1500 INSTALL KIT	285
60659	SUBKIT, C-600, 30K	287
60660	DODGE 2500/3500 INSTALL KIT	279
60661	DODGE 2500/3500 INSTALL KIT	284
60664	NISSAN TITAN GOOSENECK INSTAL	285
60667	07 TOYOTA TUNDRA SUB-KIT	285
60680	KIT, 60624 & 60611	279
60681	KIT, 60648 & 60619	279
60682	KIT, 60660 & 60619	279
60683	KIT, 60645 & 60619	279
60685	KIT, 60647 & 60619	279
60691	GM SAFETY CHAIN LOOPS	277
60692	GM SAFETY CHAIN KIT	277
60700	KIT, 60610 & 60651	280
60710	KIT, 60607 & 60604	284
60711	KIT, 60615 & 60632	284
60712	KIT, 60607 & 60652	284
60713	KIT, 60607 & 60631	284
60720	KIT, 60607 & 60644	284
60721	KIT, 60607 & 60641	284
60722	KIT, 60607 & 60637	284
60723	KIT, 60607 & 60636	284
60724	KIT, 60607 & 60649	284
60730	KIT, 60607 & 60657	284
60731	KIT, 60607 & 60658	284
60732	KIT, 60607 & 60661	284
60734	KIT, 60607 & 60635	284
60740	KIT, 60620 & 60664	284
60750	KIT, 60625 & 60665	284
60751	KIT, 60607 & 60667	284
61052	FOLDING BALL GOOSENECK HITCH A	288
61100	HITCH PLATE WITH BALL	288
61301	30K CHEV/GMC HD INSTALL KIT	289
61319	FOLDING BALL HITCH ASSEMBLY	289
61321	FOLDING BALL HITCH ASSEMBLY KI	289
61331	CHEVY 1500 C-52 KIT, 30K	289
61332	30K SUPER DUTY INSTALL KIT	289
61341	FOLDING HITCH BALL ASSEMBLY KI	289
61502	C-52 INSTALL KIT UNIVERSAL 30K	289
61503	C-52 INSTALL KIT 30K GTW	289
61504	C-52 INSTALL KIT 30K GTW	289
61505	C-52 INSTALL KIT 30K GTW	289
61506	C-52 INSTALL KIT 30K GTW	289
61509	C-52 INSTALL KIT 30K GTW	289
61529	SUBKIT, C-52, 30K	289
61652	GOOSENECK, FOLDING BALL	286
65500	FLAT HITCH PLATE 13 IN X 48 IN	288
66113	SAFETY CHAIN U-BOLT KIT	288
66145	RUBBER COVER FOR QUICKGOOSE	286
66165	REPLACEMENT CAP FOR 600 SERIES	282
80010	3/16 X 41 GRD 30 PLUS 2 J-26	334
80011	PKG 3/16 X 41 GRD30 PLUS2 J-26	334
80020	3/16 X 24 GRD 30 PLUS 1 J-26	334
80030	1/4 X 40 GRD 30 PLUS 2 J-27	334
80031	PKG 1/4 X 40 GRD30 PLUS 2 J-27	334
80040	1/4 X 23 GRD 30 PLUS 1 J-27	334
80136	CABLE, TRAILER SAFETY 3500LB	335
80151	CABLE, TRAILER SAFETY 5000LB	335
80176	CABLE, TRAILER SAFETY 7600LB	335
80300	8/0 X 23 GRD 30 PLUS 1 J-62	334
80301	8/0 X 40 GRD 30 PLUS 2 J-62	334
80302	1/4 X 33 GRD 43 PLUS 1 J-90	335
80303	1/4 X 32 GRD 70 PLUS 1 J-94	335
80304	5/16 X 32 GRD 70 PLUS 1 J-95	335
80305	5/16 X 162 GRD70 PLUS 2 J-370	336
80306	5/16 X 186 GRD 70 PLUS 2 J-370	336
80307	5/16 X 234 GRD 70 PLUS 2 J-370	336
80308	5/16 X 294 GRD 70 PLUS 2 J-370	336
80309	3/8 X 162 GRD 70 PLUS 2 J-380	336
80310	3/8 X 186 GRD 70 PLUS 2 J-380	336
80311	3/8 X 234 GRD 70 PLUS 2 J-380	336
80312	3/16 X 24 GRD30 PLUS 1 J-26SL	334
80313	1/4 X 24 GRD 30 PLUS 1 J-27SL	334
80314	5/16 X 32 GRD 43 PLUS 1 J-55	335
80315	3/8 X 31 GRD 43 PLUS 1 J-56	335

Part#	Description	Page#
80316	3/8 X 31 GRD 70 PLUS 1 J-96	335
81260	3/8IN CERTIFIED S-HOOK 2000 GT	337
81261	3/8 IN HOOK WITH SAFETY LATCH	338
81266	3/8 IN S-HOOK WITH SAFETY LATC	338
81270	7/16 IN CERTIFIED S-HOOK 5000	337
81271	CLASS 2 3500 GVWR WITH SAFETY	338
81277	7/16 IN S-HOOK WITH SAFETY LAT	338
81281	CLASS 3 5000 GVWR WITH SAFETY	338
81288	9/16 IN S-HOOK WITH SAFETY LAT	338
81330	1/4 IN CLEVIS GRAB HOOK GRADE	336
81340	5/16 IN CLEVIS GRAB HOOK GRADE	336
81350	3/8 IN CLEVIS GRAB HOOK GRADE	336
81360	SNAP HOOK WITH 5/8 IN EYE	338
81438	3/8 IN CLEVIS GRAB HOOK GRADE	336
81502	1/4 IN CLEVIS GRAB HOOK GRADE	336
81503	5/16 IN CLEVIS GRAB HOOK GRADE	336
81550	5/16 IN CLEVIS SAFETY LATCH HO	337
81560	3/8 IN SAFETY HOOK WITH LATCH	337
81620	17/32 IN CERTIFIED S-HOOK 7600	337
81640	13/32 IN S-HOOK 3500 LB CAPACI	337
81810	3/8" S-HOOK W/WIRE LATCH GTW 2	337
81820	7/16" S-HOOK W/WIRE LATCH GTW	337
81830	17/32" S-HOOK W/WIRE LATCH GTW	337
81840	13/32" S HOOK WITH SAFETY LATC	337
81900	1/4 IN CLEVIS SAFETY LATCH HOO	337
81910	1/2 IN SAFETY HOOK WITH LATCH	337
81920	5/8 IN SFTY HK W/LATCH	337
81940	1/4 IN CLEVIS SAFETY LATCH HOO	337
81950	5/16 IN SAFETY HOOK WITH LATCH	337
81960	3/8 IN SAFETY HOOK WITH LATCH	337
81970	7/16 IN CLEVIS SAFETY LATCH HO	337
81980	1/2 IN CLEVIS WITH LATCH GRADE	337
81999	YELLOW ZINC LATCH KIT IN P	337
82610	1/4 IN THREADED LINK 880 LB CA	338
82611	1/4 IN THREADED LINK 880LB CAP	338
82900	5/16 IN THREADED LINK 1760LB C	338
82901	5/16 IN THREADED LINK 1760LB C	338
82903	5/16" QUICK LINK 2 PACK	338
82930	3/8 IN THREADED LINK 2200LB CA	338
82931	7/16 IN THREADED LINK 2640LB C	338
82932	1/2 IN THREADED LINK 3300LB CA	338
82933	3/8 IN THD LINK 2200LB PKG	338
82940	9/0 JOINING LINK RAW FINISH 10	338
82942	7/16 IN JOINING LINK RAW FINIS	338
82943	9/0 JOINING LINK ZINC	338
82944	7/16 IN JOINING LINK ZINC	338
83001	RATCHET, 1" X 10', 1500#	341
83002	RATCHET, 1" X 16', 1500#	341
83009	RATCHET, 1" X 10', 1500#	341
83010	RATCHET, 1" X 16', 1500#	341
83015	CAM TIE DOWN, 1" X 15', 900#	341
83016	CAM TIE DOWN, 1" X 16', 900#	341
83019	RATCHET, 1" X 16', 2200#	341
83020	RATCHET, 1" X 16', 2200#	341
83025	RATCHET, 1-1/16" X 16', 3300#	341
83026	RATCHET, 1-1/16" X 16', 3300#	341
83027	RATCHET, 1-1/16" X 16', 3300#	341
83028	RATCHET, 1-1/16" X 16', 3300#	341
83036	RATCHET, 1-1/2" X 14', 5000#	341
83047	RATCHET, 2" X 27', 10000#	341
83048	RATCHET, 2" X 27', 10000#	341
83060	HIDE-A-TIE ROPE HOOK, BULK	359
83061	HIDE-A-TIE ROPE HOOK - PKG.	359
83066	2 IN X 30 FT VEHICLE RECOVERY	210
83072	WELD ON ANCHOR 1 5/8 IN X 3 1/	229
83600	5000 GTW RECESSED FLOOR/WALL T	342
83601	1200 GTW FOR USE WITH 3/8 IN P	343
83607	BACKING PLATE FOR J-600 AND J-	343
83710	1000 LB CAPACITY 1/4 IN DIAMET	343
83720	BLACK PLASTIC TRIM RING FOR J-	343
83730	1200 LB CAP 10 GA STL D-RING .	343
83731	1,200 LB CAP, 10 GA STL D-RING	343
83732	1200 LB CAP 10 GA STL DRING 22	343
83740	11000 LB CAPACITY 1/2 IN FORGE	343
83742	WHITE ZINC D-RING ASSEMBLY	343
83750	18800 LB CAP 5/8 IN FORGED D-R	343
83760	26500 LB CAP 3/4 IN FORGED D-R	343

Part#	Description	Page#
83770	46760 LB CAP 1 IN FORGED D-RIN	343
83780	46760 LB CAP 1 IN X 5 IN X 6 I	343
99009	CARD,HITCH HEADER,LOZIER,48X8	367
99012	SIGN,BIKE RACK DISPLAY	372
99015	DISPLAY,BALL MOUNT RACK	373
99017	BOX,DISPLAY,E16	369
99018	BOX,DISPLAY,R16	369
99019	BOX,DISPLAY,Q20	369
99020	BOX,DISPLAY,R20	369
99021	BOX,DISPLAY,Q24	369
99022	BOX,DISPLAY,R24	369
99025	BOX,DISPLAY,SPYDER/BENT PLATE	370
99026	BOX,DISPLAY,DOUBLE LOCK	370
99027	BOX,DISPLAY,X5	370
99028	DISPLAY,BALL RACK	373
99029	DISPLAY,BALL & BALL MOUNT RACK	373
99030	DISPLAY,SHELF,BULK JACKS	373
99031	LOZIER,HITCH BRACKET,OVERHEAD	373
99035	PEN, CURT	364
99039	DISPLAY,3 BIKE RACK	372
99040	SIGN,HEADER,HITCHES AVAILABLE	367
99042	BANNER, LOGO	366
99043	STICKER,WINDOW,CURT	365
99048	SIGN,LOZIER HEADER,ELECTRICAL	367
99050	HITCH HEADER CARD, FRENCH	368
99052	HEADER CARD, FRENCH,ZHS-117,CQ	367
99053	SIGN,HEADER,HITCHES AVAILABLE	367
99067	CURT RECEIVER HITCH TRI-FOLD	365
99073	DISPLAY,TRI-FLEX,BRAKE CONTROL	364
99088	TRUTRACK WD,TRI FOLD	365
99089	GOOSENECKS,TRI FOLD	365
99095	DISPLAY,2.5" ADAPTER,ZHS-102	368
99100	CURT LOGO,VINYL, 5" WIDE	364
99106	RV TOWING TRI FOLD	365
99122	HEADER CARD FOR END CAPS	367
99123	'T' BASE SIGN HOLDER FOR GONDO	365
99124	CURT LIFESTYLE POSTER	366
99125	BANNER, TRAILER HITCHES	366
99126	BANNER, TRAILER HITCHES, FRENC	366
99127	BANNER, RV TOWING, FRENCH	366
99128	BANNER, RV TOWING	366
99129	CURT TRI-FOLD LITERATURE HOLDE	365
99132	HITCH POSTER	366
99133	CURT 6 X 8 ENGLISH VERSION TWO	365
99134	CURT 6 X 8 FRENCH VERSION TWO	365
99137	LABEL, 2" X 3" CURT OVAL	365
99139	TAG, OUT OF STOCK, CURT	364

Part#	Description	Page#
99141	SIGN,OUTDOOR,METAL	367
99143	HITCH STAND, NO HEADER CARD	368
99144	FRONT MOUNT HITCH HEADER CARD	368
99145	HITCH HEADER CARD	368
99146	48" X 8" TRAILER BALL HEADER C	367
99148	48" X 8" ACCESSORIES HEADER CA	367
99150	LOCK HEADER CARD(48X8)	367
99152	CARGO CARRIER DISPLAY STAND	371
99153	CARGO CARRIER HEADER CARD	371
99154	BIKE RACK DISPLAY STAND	372
99155	BIKE RACK HEADER CARD	372
99156	Q5 5TH. WHEEL STAND W/HEADER	369
99157	CLASS I & II DISPLAY KIT	368
99158	5TH WHEEL ROLLER DISPLAY STAND	369
99159	GOOSENECK DISPLAY STAND	370
99160	16115 DISPLAY STAND	369
99162	BALLMOUNT DISPLAY	373
99170	BANNER, 5TH WHEELS	366
99171	BANNER, GOOSENECKS	366
99173	TABLE TENT,EZR GOOSENECK	367
99174	POSTER,EZR GOOSENECK	366
99180	DISPLAY,EZR DOUBLE LOCK	370
99183	DISPLAY,Q16	369
99184	BOX,DISPLAY,A16	369
99191	WINDOW STICKER HITCHES AVAIL	365
99193	DISPLAY STAND, STRAPS	373
99194	'T' BASE SIGN HOLDER 3/4" X 6"	365
99209	CARGO STRAP HEADER CARD	372
99233	BOX,DISPLAY,FORD 5TH WHEEL LEG	369
99236	BOX,DISPLAY,Q20 & Q24,FRENCH	369
99237	BOX,DISPLAY,EZR GOOSE,FRENCH	370
99246	WD DISPLAY, LOW RISE	371
99254	WD DISPLAY,DOUBLESTACK	371
99255	SIGN,WD DISPLAY STAND	371
99256	BOX,DISPLAY,Q25 5TH WHEEL	369
99257	DISPLAY,A20 AND A25 ADAPTER	369
99258	BOX,DISPLAY,A20 5TH WHEEL	369
99259	BOX,DISPLAY,A25 5TH WHEEL	369
99260	BRAKE CNTRLS,TRI FOLD	364
99261	CARGO MGMT,TRI FOLD	365
99262	OEM PUCK,TRI FOLD	365
99263	TOWING ELECTRICAL,TRI FOLD	365
99264	BALL MOUNTS,TRI FOLD	365
99265	TOWING SECY & ACCY,TRI FOLD	365
99266	TRAILER HITCHES,COUNTER MAT	367
99267	HD TOWING,COUNTER MAT	367
99269	SIGN,OUTDOOR,PLASTIC	367

CUSTOM WIRING PRODUCTS LISTED NUMERICALLY

Make / Model	Style	Years	Loc	Ins
55028				
FORD F-150	ALL	04-04	T3	5
FORD F-150 HERITAGE	ALL	04-04	T3	5
55029				
FORD F-250 SD	ALL	99-01	T3	5
FORD F-350 SD	ALL	99-01	T3	5
55050				
DODGE CALIBER	ALL, EXCL SRT	07-07	P1,P2	30
JEEP COMPASS	ALL, INCL RALLYE	07-10	P1,P2	30
JEEP PATRIOT	ALL	07-07	P1,P2	30
55057				
PONT VIBE	ALL, EXCL GT	03-08	P3,P4	25
PONT VIBE	GT	03-08	P3,P4	25
55106				
HONDA CR-V	ALL	07-11	S3	30
55124				
JEEP WRANGLER	EXCL RH DRIVE	07-17	S1	10
55240				
CHEV EXPRESS 1500	ALL	96-03	S4	5
CHEV EXPRESS 2500	ALL	96-03	S4	5
CHEV EXPRESS 3500	ALL	96-03	S4	5
GMC SAVANA 1500	ALL	96-03	S4	5
GMC SAVANA 2500	ALL	96-03	S4	5
GMC SAVANA 3500	ALL	96-03	S4	5
55241				
FORD EXPLORER	ALL	95-01	S5	5
FORD RANGER	ALL	98-99	S5	5
MAZDA B2500	ALL	98-01	S5	5
MAZDA B3000	ALL	98-01	S5	5
MAZDA B4000	ALL	98-01	S5	5
MERC MNTTEER	ALL	97-01	S5	5
55242				
FORD F-150	ALL	97-03	T3	5
FORD F-150 HERITAGE	ALL	04-04	T3	5
FORD F-250	ALL	97-99	T3	5
55243				
FORD F-250 SD	ALL	99-01	T1,T2	5
FORD F-350 SD	ALL	99-01	T1,T2	5
FORD F-450 SD	ALL	99-01	T1,T2	5
FORD F-550 SD	ALL	99-01	T1,T2	5
55244				
NISSAN XTERRA	ALL	00-04	S7	5
55245				
LEXUS LX470	ALL	01-07	S6	5
LEXUS LX570	ALL	08-11	S6	5
LEXUS RX300	ALL	01-03	S6	5
TOYOTA 4RUNNER	ALL	01-02	S6	5
TOYOTA HIGHLANDER	ALL	01-03	S6	5
TOYOTA LAND CRUISR	ALL	01-02	S6	5
55246				
TOYOTA SEQUOIA	SUV	01-02	S7	5
55247				
FORD F-250 SD	ALL	99-01	T3	5
FORD F-350 SD	ALL	99-01	T3	5
55249				
FORD EXPEDITION	ALL	97-99	S5	5
LINC NAVIGATOR	SUV	98-99	S5	5
55250				
FORD EXPEDITION	ALL	00-02	S5	5
55251				
FORD EXPLORER	4-DR	02-05	S7	5
LINC AVIATOR	ALL	03-05	S7	5
MERC MNTTEER	ALL	02-05	S7	5
55255				
FORD ESCAPE	ALL	01-04	S3	5
MAZDA TRIBUTE	ALL	01-04	S3	5
MAZDA TRIBUTE	EXCL FS SPARE	01-04	S3	5
55256				
FORD F-150	ALL	97-04	T3	5
FORD F-250	ALL	97-99	T3	5
55265				
FORD F-250 SD	ALL	02-04	T4	5
FORD F-350 SD	ALL	02-04	T4	5

Make / Model	Style	Years	Loc	Ins
55301				
FORD F-150	ALL	73-79	T3	5
FORD F-250	ALL	73-79	T3	5
FORD F-350	ALL	73-79	T3	5
55302				
FORD BRONCO	FULL SIZE	87-88	S5	5
55303				
FORD BRONCO	FULL SIZE	89-91	S5,S7	5
55304				
MAZDA B2000	ALL	86-87	T1,T2	5
MAZDA B2200	ALL	87-93	T1,T2	5
MAZDA B2600	ALL	87-93	T1,T2	5
55307				
TOYOTA RAV4	ALL	01-05	S3,S4	10
55308				
TOYOTA CAMRY	ALL	02-06	P3,P4	5
55309				
KIA SEDONA	VAN	02-05	S1,S2	25
55310				
HYUNDAI ELANTRA	TOURING	09-12	P3,P4	20
HYUNDAI SANTA FE	SUV	01-06	P3,P4	20
KIA RIO5	ALL	06-11	P3,P4	20
55311				
CHEV BLAZER	ALL	73-74	S1,S2	5
CHEV C10	ALL	75-84	S1,S2	5
CHEV C10 PICKUP	ALL	73-74	S1,S2	5
CHEV C10 SUBURBAN	ALL	73-84	S1,S2	5
CHEV C20	ALL	75-84	S1,S2	5
CHEV C20 PICKUP	ALL	73-74	S1,S2	5
CHEV C20 SUBURBAN	ALL	73-84	S1,S2	5
CHEV C30	ALL	75-84	S1,S2	5
CHEV C30 PICKUP	ALL	73-74	S1,S2	5
CHEV K10	ALL	75-84	S1,S2	5
CHEV K10 PICKUP	ALL	73-74	S1,S2	5
CHEV K10 SUBURBAN	ALL	73-84	S1,S2	5
CHEV K20	ALL	75-84	S1,S2	5
CHEV K20 PICKUP	ALL	73-74	S1,S2	5
CHEV K20 SUBURBAN	ALL	73-84	S1,S2	5
CHEV K30	ALL	77-84	S1,S2	5
CHEV K30 PICKUP	ALL	73-74	S1,S2	5
CHEV K5 BLAZER	ALL	75-84	S1,S2	5
GMC C15	ALL	75-78	S1,S2	5
GMC C15 SUBURBAN	ALL	75-78	S1,S2	5
GMC C15/C1500 PICK	ALL	73-74	S1,S2	5
GMC C15/C1500 SUBR	ALL	73-74	S1,S2	5
GMC C1500	ALL	79-84	S1,S2	5
GMC C1500 SUBURBN	ALL	79-84	S1,S2	5
GMC C25	ALL	75-78	S1,S2	5
GMC C25 SUBURBAN	ALL	75-78	S1,S2	5
GMC C25/C2500 PICK	ALL	73-74	S1,S2	5
GMC C25/C2500 SUBR	ALL	73-74	S1,S2	5
GMC C2500	ALL	79-84	S1,S2	5
GMC C2500 SUBURBN	ALL	79-84	S1,S2	5
GMC C35	ALL	75-78	S1,S2	5
GMC C35/C3500 PICK	ALL	73-74	S1,S2	5
GMC C3500	ALL	79-84	S1,S2	5
GMC K15	ALL	75-78	S1,S2	5
GMC K15 SUBURBAN	ALL	75-78	S1,S2	5
GMC K15/K1500 PICK	ALL	73-74	S1,S2	5
GMC K15/K1500 SUBR	ALL	73-74	S1,S2	5
GMC K1500	ALL	79-84	S1,S2	5
GMC K1500 SUBURBN	ALL	79-84	S1,S2	5
GMC K25	ALL	75-78	S1,S2	5
GMC K25 SUBURBAN	ALL	75-78	S1,S2	5
GMC K25/K2500 PICK	ALL	73-74	S1,S2	5
GMC K25/K2500 SUBR	ALL	73-74	S1,S2	5
GMC K2500	ALL	79-84	S1,S2	5
GMC K2500 SUBURBN	ALL	79-84	S1,S2	5
GMC K35	ALL	77-78	S1,S2	5
GMC K35/K3500 PICK	ALL	73-74	S1,S2	5
GMC K3500	ALL	79-84	S1,S2	5

Make / Model	Style	Years	Loc	Ins
55312				
CHEV C10	ALL	85-86	S1,S2	5
CHEV C10 SUBURBAN	ALL	85-86	S1,S2	5
CHEV C1500	ALL	94-94	S1,S2	5
CHEV C20	ALL	85-86	S1,S2	5
CHEV C20 SUBURBAN	ALL	85-86	S1,S2	5
CHEV C30	ALL	85-86	S1,S2	5
CHEV K10	ALL	85-86	S1,S2	5
CHEV K10 SUBURBAN	ALL	85-86	S1,S2	5
CHEV K20	ALL	85-86	S1,S2	5
CHEV K20 SUBURBAN	ALL	85-86	S1,S2	5
CHEV K30	ALL	85-86	S1,S2	5
CHEV S10	ALL	85-97	S1,S2	5
GMC C1500	ALL	85-86	S1,S2	5
GMC C1500 SUBURBN	ALL	85-86	S1,S2	5
GMC C2500	ALL	85-86	S1,S2	5
GMC C2500 SUBURBN	ALL	85-86	S1,S2	5
GMC C3500	ALL	85-86	S1,S2	5
GMC K1500	ALL	85-86	S1,S2	5
GMC K1500 SUBURBN	ALL	85-86	S1,S2	5
GMC K2500	ALL	85-86	S1,S2	5
GMC K2500 SUBURBN	ALL	85-86	S1,S2	5
GMC K3500	ALL	85-86	S1,S2	5
GMC S15	ALL	85-90	S1,S2	5
GMC SONOMA	ALL	91-97	S1,S2	5
GMC SYCLONE	ALL	91-91	S1,S2	5
ISUZU HOMBRE	ALL	96-97	S1,S2	5
55313				
FORD BRONCO	ALL	80-86	S6	5
FORD F-100	ALL	80-83	S6	5
FORD F-150	ALL	80-86	S6	5
FORD F-250	ALL	80-86	S6	5
FORD F-350	ALL	80-86	S6	5
55314				
FORD RANGER	ALL	86-92	T1,T2	5
55315				
GMC C1500	ALL	88-99	T3	5
GMC C2500	ALL	88-00	T3	5
GMC C3500	ALL	88-00	T3	5
GMC K1500	ALL	88-99	T3	5
GMC K2500	ALL	88-00	T3	5
GMC K3500	ALL	88-00	T3	5
55316				
FORD F-150	ALL	87-96	T3	5
FORD F-250	ALL	87-96	T3	5
FORD F-250 HD	ALL	97-97	T3	5
FORD F-350	ALL	87-97	T3	5
55317				
DODGE B250	ALL	94-94	T3,T5	5
DODGE D100	ALL	86-89	T3,T5	5
DODGE D150	ALL	86-89	T3,T5	5
DODGE D250	ALL	86-93	T3,T5	5
DODGE D350	ALL	86-93	T3,T5	5
DODGE DAKOTA	ALL	87-94	T3,T5	5
DODGE RAM 1500	ALL	94-94	T3,T5	5
DODGE RAM 2500	ALL	94-94	T3,T5	5
DODGE RAM 3500	ALL	94-94	T3,T5	5
DODGE RAM 50	ALL	86-93	T3,T5	5
DODGE RAMCHARGER	ALL	86-93	T3,T5	5
DODGE W100	ALL	86-89	T3,T5	5
DODGE W150	ALL	86-93	T3,T5	5
DODGE W250	ALL	86-93	T3,T5	5
DODGE W350	ALL	86-93	T3,T5	5
55318				
CHEV S10 BLAZER	ALL	84-91	S6	20

Make / Model	Style	Years	Loc	Ins
55319				
CADILLAC ESCALADE	ALL	99-00	S7	5
CHEV BLAZER	ALL	92-94	S7	5
CHEV C1500 SUBURBN	ALL	92-99	S7	5
CHEV C2500 SUBURBN	ALL	92-99	S7	5
CHEV K1500 SUBURBN	ALL	92-99	S7	5
CHEV K2500 SUBURBN	ALL	92-99	S7	5
CHEV TAHOE	ALL	95-00	S7	5
GMC C1500 SUBURBN	ALL	92-99	S7	5
GMC C2500 SUBURBN	ALL	92-99	S7	5
GMC K1500 SUBURBN	ALL	92-99	S7	5
GMC K2500 SUBURBN	ALL	92-99	S7	5
GMC YUKON	ALL	92-00	S7	5
GMC YUKON XL 1500	ALL	00-00	S7	5
GMC YUKON XL 2500	ALL	00-00	S7	5
55323				
CHRY TOWN & CNTRY	2WD ONLY	91-95	S1,S2	10
DODGE CARAVAN	2WD ONLY	91-95	S1,S2	10
DODGE DAKOTA	PICKUP, ALL	04-10	S1,S2	10
MITSU RAIDER	ALL	06-09	S1,S2	10
PLYMOUTH VOYAGER	VAN	91-95	S1,S2	10
55324				
FORD EXPLORER	ALL	91-94	S1	20
MAZDA NAVAJO	SUV	91-94	S1	20
55325				
FORD RANGER	ALL	93-99	T3	5
MAZDA B2300	ALL	94-08	T3	5
MAZDA B2500	ALL	98-01	T3	5
MAZDA B3000	ALL	94-07	T3	5
MAZDA B4000	ALL	94-08	T3	5
55326				
FORD CROWN VIC	ALL	92-97	P3,P4	20
FORD MUSTANG	ALL, EXCL GT	94-04	P3,P4	20
MERC GRAND MQUIS	SEDAN	92-97	P3,P4	20
55327				
FORD TAURUS	ALL	92-95	P3,P4	10
55328				
DODGE B150	ALL	93-94	S7	5
DODGE B1500	ALL	95-98	S7	5
DODGE B250	ALL	93-94	S7	5
DODGE B2500	ALL	95-98	S7	5
DODGE B350	ALL	93-94	S7	5
DODGE B3500	ALL	95-98	S7	5
55329				
DODGE DAKOTA	ALL	95-03	T3,T5	5
DODGE RAM 1500	ALL	95-01	T3,T5	5
DODGE RAM 2500	ALL	95-02	T3,T5	5
DODGE RAM 3500	ALL	95-02	T3,T5	5
55330				
JEEP CHRKEE	ALL, INCL SPORT	91-96	S3	20
55331				
HONDA PASSPORT	ALL	94-97	S1,S2	5
ISUZU RODEO	ALL	92-97	S1,S2	5
55333				
FORD TAURUS	ALL	96-99	P3,P4	10
MERC SABLE	SEDAN	96-99	P3,P4	10
55334				
CHRY TOWN & CNTRY	EXCL STOW-N-GO	96-96	S1,S2	20
CHRY TOWN & CNTRY	EXCL STOW-N-GO	96-00	S1,S2	20
DODGE CARAVAN	ALL	96-00	S1,S2	20
DODGE DURANGO	ALL	98-03	S1,S2	20
PLYMOUTH VOYAGER	VAN	96-00	S1,S2	20
55335				
CHEV EXPRESS 1500	ALL	96-99	S3,S4	20
CHEV EXPRESS 2500	ALL	96-99	S3,S4	20
CHEV EXPRESS 3500	ALL	96-99	S3,S4	20
GMC SAVANA 1500	ALL	96-99	S3,S4	20
GMC SAVANA 2500	ALL	96-99	S3,S4	20
GMC SAVANA 3500	ALL	96-99	S3,S4	20
55336				
ACURA CL	ALL	97-03	P3	10
ACURA INTEGRA	ALL	94-01	P3	10
ACURA MDX	ALL	01-07	P3	10
ACURA RL	ALL	96-01	P3	10
ACURA TL	ALL	96-03	P3	10
HONDA ACCORD	COUPE	94-02	P3	10
HONDA ACCORD	SEDAN	94-02	P3	10

Make / Model	Style	Years	Loc	Ins
HONDA CR-V	ALL	97-06	P3	10
HONDA ELEMENT	EXCL SC	03-04	P3	10
HONDA ODYSSEY	ALL	95-04	P3	10
HONDA PILOT	ALL	03-08	P3	10
ISUZU OASIS	VAN	96-99	P3	10
55337				
CHEV LUMINA APV	VAN	93-96	S1,S2	20
OLDS SILHOUETTE	VAN	93-96	S1,S2	20
PONT TRANS SPORT	ALL	93-96	S1,S2	20
55338				
CHEV G10	ALL	87-95	S1,S2	10
CHEV G20	ALL	87-95	S1,S2	10
CHEV G30	ALL	87-95	S1,S2	10
GMC G1500	ALL	87-95	S1,S2	10
GMC G2500	ALL	87-95	S1,S2	10
GMC G3500	ALL	87-95	S1,S2	10
55339				
ACURA SLX	ALL	96-99	S5	10
ISUZU TROOPER	ALL	92-02	S5	10
55341				
TOYOTA 4RUNNER	ALL	96-02	S3,S4	20
55343				
FORD E-150 ECOLN	ALL	92-94	S1,S2	10
FORD E-150 ECOLN CLUB WAGON	ALL	92-94	S1,S2	10
FORD E-250 ECOLN	ALL	92-94	S1,S2	10
FORD E-350 ECOLN	ALL	92-94	S1,S2	10
FORD E-350 ECOLN CLUB WAGON	ALL	92-94	S1,S2	10
FORD ESCAPE	ALL	01-03	S1,S2	10
MAZDA TRIBUTE	ALL	01-03	S1,S2	10
MAZDA TRIBUTE	ALL	01-03	S1,S2	10
MERC SABLE	WAGON	96-05	S1,S2	10
55344				
FORD E-150	ALL	03-03	S1,S2	10
FORD E-150 CLB WGN	ALL	03-03	S1,S2	10
FORD E-150 ECOLN	ALL	95-02	S1,S2	10
FORD E-150 ECOLN CW	ALL	95-02	S1,S2	10
FORD E-250	ALL	03-03	S1,S2	10
FORD E-250 ECOLN	ALL	95-02	S1,S2	10
FORD E-350 CLUB WGN	ALL	03-03	S1,S2	10
FORD E-350 ECOLN	ALL	95-98	S1,S2	10
FORD E-350 ECOLN CW	ALL	95-02	S1,S2	10
FORD E-350 SD	ALL	99-03	S1,S2	10
FORD E-450 ECOLN SD	ALL	00-02	S1,S2	10
FORD E-450 SD	ALL	03-03	S1,S2	10
FORD E-550 ECOLN SD	ALL	02-02	S1,S2	10
FORD E-550 SD	ALL	03-03	S1,S2	10
FORD ECOLN SD	ALL	96-99	S1,S2	10
FORD ESCORT	SEDAN	98-00	S1,S2	10
FORD ESCORT	ZX2	98-02	S1,S2	10
FORD EXPEDITION	ALL	97-03	S1,S2	10
FORD EXPLORER	ALL	01-03	S1,S2	10
FORD EXPLR SPT TRAC	ALL	02-03	S1,S2	10
FORD F-150	CREW CAB	01-03	S1,S2	10
FORD F-150	FLARESIDE	95-03	S1,S2	10
FORD F-150 HERITAGE	ALL	04-04	S1,S2	10
FORD FOCUS	WAGON	01-03	S1,S2	10
FORD RANGER	ALL	00-03	S1,S2	10
LINC AVIATOR	ALL	03-04	S1,S2	10
LINC NAVIGATOR	SUV	98-03	S1,S2	10
MERC MNTTEER	ALL	02-05	S1,S2	10
MERC TRACER	ALL	97-99	S1,S2	10
55345				
FORD EXPLORER	ALL	95-01	S1,S2	40
MERC MNTTEER	ALL	97-01	S1,S2	40
MERC MNTTEER	ALL	97-01	S1,S2	40
55346				
FORD WINDSTAR	VAN	95-98	S1,S2	20
55347				
BUICK ROADMASTER	ALL	91-96	P3,P4	10
CHEV CAPRICE	SEDAN	91-96	P3,P4	10
55349				
JEEP GRAND CHRKEE	INCL LAREDO	94-98	S3,S4	25
55350				
FORD BRONCO	FULL SIZE	92-96	S6	5
55351				
MERC SABLE	SEDAN	92-95	P3,P4	10

Make / Model	Style	Years	Loc	Ins
55352				
BUICK ROADMASTER	ESTATE WAGON	91-95	P3,P4	10
BUICK ROADMASTER	CLLECTR'S EDTN	96-96	P3,P4	10
CHEV CAPRICE	WAGON	91-96	P3,P4	10
OLDS CUSTOM CRUSR	WAGON	91-92	P3,P4	10
55353				
NISSAN PATHFINDER	ALL	87-95	S1,S2	10
NISSAN PICKUP	ALL	95-97	S1,S2	10
55354				
JEEP CHRKEE	ALL, INCL SPORT	97-01	S3	20
55355				
CHEV VENTURE	ALL	97-05	S3	10
OLDS SILHOUETTE	ALL	97-04	S3	10
PONT MONTANA	ALL	99-09	S3	10
PONT TRANS SPORT	ALL	97-98	S3	10
55356				
JEEP TJ	ALL	97-97	S5,S7	10
JEEP WRANGLER	ALL	91-97	S5,S7	10
55358				
TOYOTA CAMRY	ALL	97-01	P3,P4	5
55359				
CHEV S10	ALL	98-04	T3	5
GMC SONOMA	ALL	98-04	T3	5
ISUZU HOMBRE	ALL	98-00	T3	5
55360				
HONDA PASSPORT	ALL	98-02	S1,S2	15
ISUZU AMIGO	ALL	98-00	S1,S2	15
ISUZU RODEO	ALL	98-04	S1,S2	15
ISUZU RODEO	ALL	04-04	S1,S2	15
55361				
INFINITI QX4	ALL	97-03	S1,S2	20
NISSAN ALTIMA	SEDAN	98-01	S1,S2	20
NISSAN PATHFINDER	ALL	96-04	S1,S2	20
55362				
MERC VILLAGER	VAN	98-98	S1,S2	20
NISSAN FRONTIER	2-DR SHORT BOX	00-03	S1,S2	20
NISSAN FRONTIER	4-DR SHORT BOX	00-03	S1,S2	20
NISSAN FRONTIER	ALL	98-99	S1,S2	20
NISSAN QUEST	VAN	98-98	S1,S2	20
55363				
JEEP TJ	ALL	98-06	S5,S7	10
JEEP WRANGLER	ALL	98-06	S5,S7	10
55364				
CHRY 300M	ALL	99-01	P1,P2	15
CHRY 300M	ALL, EXCL SPECL	02-04	P1,P2	15
CHRY CONCORDE	PASSENGER	98-01	P1,P2	15
CHRY LHS	ALL	99-99	P1,P2	15
DODGE INTREPID	ALL	98-04	P1,P2	15
55365				
LEXUS LX470	ALL	98-99	S6	5
TOYOTA LAND CRUISR	ALL	98-99	S6	5
55366				
FORD WINDSTAR	VAN	99-03	S1,S3	25
55367				
TOYOTA TUNDRA	ALL	00-00	T3	10
55368				
DODGE RAM 1500 VAN	ALL	99-00	S5	5
DODGE RAM 2500 VAN	ALL	99-00	S5	5
DODGE RAM 3500 VAN	ALL	99-00	S5	5
55369				
JEEP GRAND CHRKEE	ALL	99-04	S3	10
55370				
SUBA B9 TRIBECA	ALL	06-07	S8	10
SUBA FORESTER	ALL	98-08	S8	10
SUBA IMPREZA	WRX, WAGON	04-04	S8	10
SUBA LEGACY	SEDAN OR WGN	96-99	S8	10
SUBA OUTBACK	WAGON	00-09	S8	10
SUBA TRIBECA	ALL	08-14	S8	10
55371				
KIA SPORTAGE	ALL	98-02	S3,S4	20
55372				
CHEV TRACKER	ALL	98-04	S1,S2	5
SUZUKI GRAND VITARA	ALL	99-05	S1,S2	5
SUZUKI SIDEKICK	ALL	89-98	S1,S2	5
SUZUKI VITARA	ALL	99-04	S1,S2	5
SUZUKI XL-7	ALL	02-06	S1,S2	5

Make / Model	Style	Years	Loc	Ins
55373				
LINC LS	ALL	00-06	P3,P4	20
55375				
FORD TAURUS	SEDAN	00-03	P3,P4	10
MERC SABLE	SEDAN	00-03	P3,P4	10
55376				
CHRY TOWN & CNTRY	EXCL STOW-N-GO	01-03	S1,S2	15
CHRY VOYAGER	ALL	01-03	S1,S2	15
DODGE CARAVAN	ALL	01-03	S1,S2	15
55377				
CHEV EXPRESS 1500	ALL	00-02	S3,S4	10
CHEV EXPRESS 2500	ALL	00-02	S3,S4	10
CHEV EXPRESS 3500	ALL	00-02	S3,S4	10
GMC SAVANA 1500	ALL	00-02	S3,S4	10
GMC SAVANA 2500	ALL	00-02	S3,S4	10
GMC SAVANA 3500	ALL	00-02	S3,S4	10
55378				
TOYOTA TUNDRA	ALL	01-02	T3	10
55379				
TOYOTA PICKUP	ALL	89-95	T1,T2	10
TOYOTA TACOMA	ALL	95-04	T1,T2	10
55380				
MITSU MONTERO	2 OR 4-DR	01-06	S1,S2	20
55381				
CHRY ASPEN	ALL	07-08	S6	5
CHRY PACIFICA	ALL	04-08	S6	5
DODGE DAKOTA	ALL	00-09	S6	5
DODGE DURANGO	ALL	00-08	S6	5
DODGE RAM 1500	ALL	00-08	S6	5
DODGE RAM 1500 VAN	ALL	01-03	S6	5
DODGE RAM 2500	ALL	03-09	S6	5
DODGE RAM 2500 VAN	ALL	01-03	S6	5
DODGE RAM 3500	ALL	00-09	S6	5
DODGE RAM 3500 VAN	ALL	01-03	S6	5
DODGE SPRINTR 2500	ALL	03-09	S6	5
DODGE SPRINTR 3500	ALL	03-09	S6	5
FRGHT SPRINTR 2500	ALL	03-09	S6	5
FRGHT SPRINTR 3500	ALL	03-09	S6	5
JEEP COMMANDER	ALL	06-10	S6	5
JEEP GRAND CHRKEE	ALL	00-10	S6	5
JEEP LIBERTY	ALL	05-08	S6	5
MITSU RAIDER	ALL	06-09	S6	5
55382				
JEEP LIBERTY	ALL	02-07	S1,S2	10
55383				
BUICK RENDEZVOUS	ALL	02-07	S1,S2	20
PONT AZTEK	ALL	01-05	S1,S2	20
55400				
HYUNDAI AZERA	SEDAN, V6	06-11		20
TOYOTA HIGHLANDER	BASE	01-07		20
TOYOTA HIGHLANDER	LTD	01-07		20
TOYOTA HIGHLANDER	SPORT	06-07		20
55411				
CHEV ASTRO	ALL	95-05	S4	15
CHEV BLAZER	ALL	95-02	S4	15
GMC JIMMY	ALL	95-01	S4	15
GMC SAFARI	ALL	95-04	S4	15
55414				
JEEP COMMANDER	ALL	06-10	S1,S2	15
55418				
TOYOTA SIENNA	VAN	98-03	S3,S4	10
55432				
CHEV COBALT	COUPE	05-10	P1,P2	15
CHEV HHR	ALL	06-11	P1,P2	15
PONT G5	COUPE	07-09	P1,P2	15
PONT PURSUIT	COUPE	05-06	P1,P2	15
55434				
CHEV COBALT	SEDAN	05-10	P1,P2	10
PONT G5	SEDAN	07-09	P1,P2	10
PONT PURSUIT	SEDAN	05-06	P1,P2	10
55441				
NISSAN FRONTIER	ALL	05-17	T3	5
NISSAN PATHFINDER	ALL	05-10	T3	5
NISSAN XTERRA	ALL	05-15	T3	5
SUZUKI EQUATOR	ALL	09-12	T3	5
55451				
JEEP GRAND CHRKEE	ALL	05-06	S1,S2	20

Make / Model	Style	Years	Loc	Ins
55486				
TOYOTA RAV4	ALL	96-00	S3,S4	20
55493				
CHRY TOWN & CNTRY	ALL	90-90	S1,S2	10
DODGE CARAVAN	2WD ONLY	89-90	S1,S2	10
PLYMOUTH VOYAGER	VAN	89-90	S1,S2	10
55495				
JEEP CHRKEE	ALL	76-82	S5	10
55502				
ACURA TSX	ALL	06-14	P3,P4	10
HONDA ACCORD	COUPE	08-08	P3,P4	10
HONDA ACCORD	SEDAN	03-12	P3,P4	10
55503				
HYUNDAI ENTOURAGE	ALL	07-09	S1,S2	25
KIA SEDONA	ALL	06-12	S1,S2	25
KIA SEDONA	LNG WHEEL BASE	07-14	S1,S2	25
KIA SEDONA	SHT WHEEL BASE	07-10	S1,S2	25
55504				
DODGE RAM 1500	ALL	02-05	T3,T5	10
DODGE RAM 2500	ALL	03-05	T3,T5	10
DODGE RAM 3500	ALL	03-05	T3,T5	10
55510				
CHEV COLORADO	ALL	04-12	T3	10
GMC CANYON	ALL	06-06	T3	10
GMC CANYON	PICKUP	04-12	T3	10
ISUZU I-280	ALL	06-06	T3	10
ISUZU I-290	ALL	07-08	T3	10
ISUZU I-350	ALL	06-06	T3	10
ISUZU I-370	ALL	07-08	T3	10
55513				
TOYOTA HILUX	ALL	08-12	T3,T5	10
TOYOTA T100	ALL	93-98	T3,T5	10
TOYOTA TACOMA	ALL	05-15	T3,T5	10
55522				
TOYOTA ECHO	EXCL CDN MODLS	00-02	P3,P4	20
TOYOTA MATRIX	ALL	03-08	P3,P4	20
TOYOTA MATRIX	XR OR XRS	03-08	P3,P4	20
55525				
FORD WINDSTAR	VAN	03-03	S1,S2	25
55528				
HYUNDAI TUCSON	SUV	05-09	S1,S2	20
55529				
KIA SPORTAGE	ALL	05-10	S5	5
55530				
CHRY PACIFICA	ALL	04-08	S1,S2	25
55532				
CHRY PT CRUISER	ALL	01-10	P1,P2	20
55534				
CHRY 300	ALL	05-07	P3,P4	10
DODGE CHALLENGER	ALL	08-14	P3,P4	10
DODGE CHARGER	ALL	06-10	P3,P4	10
55537				
CHRY TOWN & CNTRY	WITH STOW-N-GO	04-07	S1,S2	20
DODGE CARAVAN	EXCL SPORT	04-07	S1,S2	20
DODGE CARAVAN	WITH STOW-N-GO	04-07	S1,S2	20
DODGE GRND CARAVAN	EXCL SPORT	04-07	S1,S2	20
DODGE GRND CARAVAN	WITH STOW-N-GO	04-07	S1,S2	20
55540				
CHEV EXPRESS 1500	ALL	03-14	S3,S4	20
CHEV EXPRESS 2500	ALL	03-17	S3,S4	20
CHEV EXPRESS 3500	ALL	03-17	S3,S4	20
GMC SAVANA 1500	ALL	03-14	S3,S4	20
GMC SAVANA 2500	ALL	03-17	S3,S4	20
GMC SAVANA 3500	ALL	03-17	S3,S4	20
55542				
TOYOTA COROLLA	SEDAN	03-13	P3,P4	15
55546				
CHRY 300	C	05-10	P3,P4	15
CHRY 300	C SRT8	05-05	P3,P4	15
55550				
KIA SORENTO	ALL	03-06	S7	5
55560				
CHEV EQUINOX	ALL	05-06	S3	5
PONT TORRENT	ALL	06-06	S3	5
55562				
DODGE MAGNUM	ALL	05-08	P1,P2	30

Make / Model	Style	Years	Loc	Ins
55563				
LEXUS RX330	ALL	04-06	S3,S4	20
LEXUS RX350	ALL	07-12	S3,S4	20
55565				
MITSU OUTLANDER	ALL	03-06	S3,S4	25
55567				
MAZDA 3	SEDAN	14-18	P3,P4	25
MAZDA 6	HATCH	04-08	P3,P4	25
MAZDA 6	SEDAN	03-08	P3,P4	25
TOYOTA CAMRY	ALL	12-17	P3,P4	25
TOYOTA CAMRY	BASE	09-09	P3,P4	25
TOYOTA CAMRY	CE	07-08	P3,P4	25
TOYOTA CAMRY	LE	07-09	P3,P4	25
TOYOTA CAMRY	SE	07-09	P3,P4	25
TOYOTA CAMRY	XLE	07-09	P3,P4	25
TOYOTA COROLLA	ALL	17-17	P3,P4	25
TOYOTA COROLLA	ECO PLUS, SEDAN	14-14	P3,P4	25
TOYOTA COROLLA	ECO, SEDAN	14-14	P3,P4	25
TOYOTA COROLLA	L, SEDAN	14-18	P3,P4	25
TOYOTA COROLLA	LE ECO, SEDAN	15-18	P3,P4	25
TOYOTA COROLLA	LE, SEDAN	14-18	P3,P4	25
TOYOTA COROLLA	S, SEDAN	14-16	P3,P4	25
TOYOTA COROLLA	SE, SEDAN	17-18	P3,P4	25
TOYOTA COROLLA	SPECIAL EDITION	16-16	P3,P4	25
TOYOTA COROLLA	XLE, SEDAN	17-18	P3,P4	25
TOYOTA COROLLA	XSE, SEDAN	17-18	P3,P4	25
TOYOTA FJ CRUISER	ALL	07-14	P3,P4	25
55570				
NISSAN QUEST	VAN	04-09	S1,S2	10
55571				
NISSAN MURANO	ALL	03-14	S3,S4	25
55580				
TOYOTA SIENNA	VAN	04-10	S1,S2	10
55585				
HONDA RIDGELINE	ALL	06-14	T1,T2	10
55587				
FORD FIVE HUNDRED	ALL	05-07	P3,P4	10
FORD FREESTYLE	ALL	05-07	P3,P4	10
55593				
MAZDA CX-7	ALL	07-12	S4	25
55597				
CHRY ASPEN	ALL	07-09	S1,S2	25
DODGE DURANGO	ALL	04-09	S1,S2	25
56002				
SUZUKI GRAND VITARA	ALL	06-12	S3,S4	20
SUZUKI SX4	ALL	07-11	S3,S4	20
56008				
ACURA RDX	ALL	07-18	P3	30
HONDA ACCORD CRSTR	ALL	10-11	P3	30
56009				
JEEP GRAND CHRKEE	ALL	07-13	S1,S2	15
56010				
MAZDA MPV	ALL	00-06	S3,S4	20
56011				
HONDA ACCORD	COUPE	11-12	P3,P4	20
HONDA ACCORD	CPE, EX LED TAILS	13-15	P3,P4	20
HONDA ACCORD	SDN, EX LED TAILS	13-15	P3,P4	20
HONDA CIVIC	SDN, EXCL HYBRD	06-15	P3,P4	20
HONDA FIT	5-DR	09-13	P3,P4	20
HONDA FIT	5-DR SPORT	07-08	P3,P4	20
MAZDA 3	ALL	10-13	P3,P4	20
MAZDA 3	SEDAN	10-13	P3,P4	20
MAZDA 3	EXCL MAZDASPD	04-09	P3,P4	20
MAZDA CX-5	ALL	13-15	P3,P4	20
MITSU GALANT	SEDAN, 2.4L	09-12	P3,P4	20
56012				
CHEV EQUINOX	ALL	07-09	S3	15
PONT TORRENT	ALL	07-09	S3	15
SUZUKI XL-7	ALL	07-08	S3	15
56013				
CHEV MALIBU	ALL	04-07	P1,P2	20
PONT G6	COUPE	05-09	P1,P2	20
PONT G6	SEDAN	05-09	P1,P2	20
56014				
CHEV CORVETTE	ALL	05-11	P1,P2	20
FORD FOCUS	2 OR 4-DR	07-11	P1,P2	20
FORD RANGER	ALL	11-11	P1,P2	20

Make / Model	Style	Years	Loc	Ins
56015				
FORD TAURUS	SEDAN (NEW STYL)	08-09	P3,P4	20
MERC SABLE	SEDAN	08-09	P3,P4	20
56016				
MAZDA 2	3 OR 5-DR	11-14	P3,P4	30
MAZDA 5	ALL	06-15	P3,P4	30
MAZDA CX-9	ALL	07-15	P3,P4	30
56017				
SATURN AURA	SEDAN	07-09	P1,P2	20
56018				
SATURN VUE	ALL	02-07	S1,S2	15
56020				
FORD E-150	ALL	04-14	S1,S2	15
FORD E-250	ALL	04-14	S1,S2	15
FORD E-350 SD	ALL	04-14	S1,S2	15
56021				
NISSAN VERSA	HATCH	07-12	P3,P4	30
NISSAN VERSA	ALL	07-11	P3,P4	30
56022				
NISSAN ALTIMA	ALL	07-15	P3,P4	30
NISSAN ALTIMA	COUPE	08-13	P3,P4	30
NISSAN ALTIMA	SEDAN	08-13	P3,P4	30
NISSAN MAXIMA	SEDAN	07-14	P3,P4	30
NISSAN SENTRA	SEDAN	07-12	P3,P4	30
56025				
SATURN OUTLOOK	ALL	07-10	S1,S2	15
56026				
CHEV CAPTIVA SPORT	ALL	12-12	S3,S4	30
SATURN VUE	ALL	08-10	S3,S4	30
56027				
BUICK ENCLAVE	ALL	08-12	S1,S2	10
CHEV MALIBU	CLASSIC LS	08-08	S1,S2	10
CHEV MALIBU	CLASSIC LT	08-08	S1,S2	10
CHEV MALIBU	LS	08-12	S1,S2	10
CHEV MALIBU	LT	08-12	S1,S2	10
CHEV TRAVERSE	ALL	09-12	S1,S2	10
56028				
DODGE AVENGER	ALL, INCL RT	08-10	P1,P2	30
DODGE AVENGER	EXCL RT	08-10	P1,P2	30
56029				
HONDA ELEMENT	EXCL SC	07-11	S8	20
HONDA ELEMENT	SC	07-10	S8	20
56030				
SCION XB	ALL	04-06	S1,S2	20
56031				
FORD F-150	ALL	97-07	T3	10
FORD F-150 HERITAGE	ALL	04-04	T3	10
56032				
FORD F-250 SD	ALL	03-07	T3	10
FORD F-350 SD	ALL	03-07	T3	10
56033				
INFINITI G25	ALL	11-12	P3,P4	30
INFINITI G25	SEDAN	11-12	P3,P4	30
INFINITI G35	SEDAN, INCL X	07-08	P3,P4	30
INFINITI G37	SEDAN, INCL X	09-13	P3,P4	30
NISSAN ROGUE	ALL	08-17	P3,P4	30
56035				
PONT VIBE	ALL, EXCL GT	09-10	P3,P4	30
PONT VIBE	GT	09-10	P3,P4	30
SCION XB	ALL	11-15	P3,P4	30
TOYOTA MATRIX	ALL	09-13	P3,P4	30
56036				
SATURN ION	ALL	03-07	P1,P2	10
56037				
DODGE JOURNEY	ALL	09-09	S1,S2	30
56038				
ACURA MDX	ALL	07-13	S3	30
56039				
MITSU ENDEAVOR	ALL	04-11	S3	15
56040				
SUBA CROSSTREK	2.0I BASE	18-18	S4	10
SUBA CROSSTREK	2.0I LTD	18-18	S4	10
SUBA CROSSTREK	2.0I PREMIUM	18-18	S4	10
SUBA CROSSTREK	BASE	16-17	S4	10
SUBA CROSSTREK	LTD	16-17	S4	10
SUBA CROSSTREK	PREMIUM	16-16	S4	10
SUBA FORESTER	ALL	09-18	S4	10

Make / Model	Style	Years	Loc	Ins
SUBA OUTBACK	ALL	10-17	S4	10
SUBA XV CROSSTREK	ALL	13-13	S4	10
SUBA XV CROSSTREK	BASE	15-15	S4	10
SUBA XV CROSSTREK	LTD	14-15	S4	10
SUBA XV CROSSTREK	PREMIUM	14-15	S4	10
56041				
HYUNDAI GENESIS	SEDAN	09-14	P3,P4	20
56042				
TOYOTA HIGHLANDER	WITH PREP PKG	08-17	S3	20
56043				
CADILLAC CTS	ALL	03-07	P3,P4	45
56044				
CADILLAC CTS	COUPE	11-15	P1,P2	20
CADILLAC CTS	SEDAN	08-13	P1,P2	20
56045				
VOLVO XC90	ALL	05-14	S3,S4	20
56046				
CHEV IMPALA	ALL	06-13	P2	10
56047				
BUICK LUCERNE	ALL	06-11	P3,P4	10
FORD FIESTA	SEDAN	11-17	P3,P4	10
56048				
FORD FUSION	ALL	06-12	P3,P4	30
56049				
HYUNDAI ELANTRA	SEDAN	07-10	P3,P4	10
HYUNDAI SONATA	ALL	06-10	P3,P4	10
HYUNDAI SONATA	GLS	11-14	P3,P4	10
HYUNDAI SONATA	LTD	11-14	P3,P4	10
HYUNDAI SONATA	SE	11-14	P3,P4	10
KIA OPTIMA	SEDAN	09-09	P3,P4	10
56050				
HONDA ACCORD	COUPE	06-07	P3	10
56051				
HONDA CIVIC	COUPE	15-15	P3,P3	10
HONDA CIVIC	COUPE, EXCL HYB	06-14	P3,P3	10
56053				
HONDA ACCORD	COUPE	03-05	P3	10
56054				
CHRY SEBRING	CONVERTIBLE	08-10	P1,P2	45
CHRY SEBRING	SEDAN	07-10	P1,P2	45
56055				
FORD TAURUS X	113 IN. WHL BASE	08-09	S3,S4	15
56056				
GMC ACADIA	ALL	07-12	S1,S2	15
56057				
KIA OPTIMA	SEDAN	07-08	P3,P4	10
56058				
KIA AMANTI	ALL	07-09	P3,P4	45
KIA OPTIMA	SEDAN	11-15	P3,P4	45
56059				
VOLVO S80	ALL	07-16	P3,P4	45
56060				
VOLVO V70	WAGON	08-10	P1,P2	45
56061				
SUBA IMPREZA	ALL	08-14	P3,P4	45
56062				
SCION XB	ALL	08-10	S3,S4	45
56063				
FORD FLEX	ALL	09-18	P3,P4	10
56064				
FORD FIESTA	HATCH	11-13	P3,P4	40
LINC MKS	ALL	09-10	P3,P4	40
56066				
SUZUKI SX4	SEDAN	08-09	S3,S4	20
56069				
VOLVO S40	ALL	08-11	P3,P4	45
56073				
FORD FREESTAR	ALL	04-07	S6	5
MERC MONTEREY	MINIVAN	04-07	S6	5
56074				
INFINITI FX35	ALL	09-12	S3,S4	30
INFINITI FX37	ALL	13-13	S3,S4	30
INFINITI FX50	ALL	09-13	S3,S4	30
56075				
FORD ESCAPE	ALL	05-07	S1,S2	10
FORD ESCAPE	ALL, INCL HYBRID	05-07	S1,S2	10
MAZDA TRIBUTE	ALL	05-06	S1,S2	10

Make / Model	Style	Years	Loc	Ins
56076				
PONT GRAND PRIX	GT COUPE	04-08	P1,P2	15
PONT GRAND PRIX	SE SEDAN	04-08	P1,P2	15
56077				
BUICK TERRAZA	ALL	05-07	S3	15
CHEV UPLANDER	ALL	06-08	S3	15
PONT MONTANA	SV6	06-06	S3	15
PONT MONTANA	SV6	06-06	S3	15
SATURN RELAY	ALL	05-07	S3	15
56078				
HYUNDAI SANTA FE	SUV	07-12	S3,S4	20
KIA FORTE	SEDAN	10-14	S3,S4	20
56079				
TOYOTA AVALON	WITH DUAL EXHS	11-12	P3,P4	45
TOYOTA CAMRY	ALL, EXCL SE	07-11	P3,P4	45
TOYOTA VENZA	ALL	09-16	P3,P4	45
56081				
CHEV AVEO	ALL	04-06	P3,P4	20
CHEV AVEO5	ALL	07-11	P3,P4	20
PONT G3	HATCH	09-09	P3,P4	20
56082				
MAZDA MX-5 MIATA	ALL	06-15	P3,P4	20
56083				
LEXUS RX350	WITH TOW PKG	10-17	S5	5
LEXUS RX450H	WITH TOW PKG	10-17	S5	5
56084				
NISSAN CUBE	ALL	09-14	P3,P4	20
56085				
HYUNDAI GENESIS CPE	ALL	10-16	P3,P4	45
56086				
HONDA PILOT	ALL	09-11	S5	20
56087				
SUZUKI EQUATOR	ALL	09-11	T4	5
56088				
FORD MUSTANG	ALL	10-17	P3,P4	40
56089				
CHEV CAMARO	ALL	10-11	P1,P2	15
56090				
FORD TRANS CNVCT	ALL	10-13	S1,S2	45
56091				
SUBA LEGACY	SEDAN	10-14	P3,P4	20
56092				
CHEV AVEO	ALL	07-11	P3	15
56093				
FORD TAURUS	ALL	10-17	S3,S4	45
LINC MKS	ALL	13-16	S3,S4	45
56094				
CHEV EQUINOX	ALL	10-17	S1,S2	20
GMC TERRAIN	ALL	10-17	S1,S2	20
56095				
LINC MKT	EXCL ECOBOOST	10-15	S1,S2	45
LINC MKT	WITH ECOBOOST	10-15	S1,S2	45
56096				
CADILLAC SRX	ALL	10-16	S6	5
56097				
HONDA PILOT	ALL	09-11	S5	20
56098				
BUICK LACROSSE	ALL	10-16	P1,P2	45
56099				
LEXUS CT200H	ALL	11-11	P3,P4	20
LEXUS HS250H	ALL	10-12	P3,P4	20
56102				
MITSU OUTLANDER	ALL	07-13	S4	25
56103				
SUZUKI KIZASHI	SEDAN	10-11	P3,P4	20
56104				
KIA BORREGO	ALL	09-09	S1,S2	45
56105				
NISSAN MURANO	ALL	06-07	S3,S4	45
56106				
TOYOTA SIENNA	ALL	11-14	S1,S2	45
TOYOTA SIENNA	SE	15-17	S1,S2	45
56107				
TOYOTA HIGHLANDER	ALL	04-07	S3	20
56108				
ACURA ZDX	ALL	10-13	S4	45

Make / Model	Style	Years	Loc	Ins
56109				
DODGE JOURNEY	SE	17-17	S1,S2	15
DODGE JOURNEY	W/O LED TAILS	10-16	S1,S2	15
56110				
FORD F-150	FX2	10-14	T3	10
FORD F-150	FX4	10-14	T3	10
FORD F-150	HARLEY EDITION	10-12	T3	10
FORD F-150	KING RANCH	10-18	T3	10
FORD F-150	LARIAT	10-18	T3	10
FORD F-150	LARIAT LTD	11-11	T3	10
FORD F-150	LTD	13-18	T3	10
FORD F-150	PLATINUM	10-18	T3	10
FORD F-150	RAPTOR	17-18	T3	10
FORD F-150	SSV	16-18	T3	10
FORD F-150	STX	10-14	T3	10
FORD F-150	SVT RAPTOR	10-14	T3	10
FORD F-150	XL	10-18	T3	10
FORD F-150	XLT	10-18	T3	10
56111				
SUBA IMPREZA	2.5i 5-DR WAGON	08-11	P1,P2	45
SUBA IMPREZA	ALL	12-12	P1,P2	45
SUBA IMPREZA	W/ QUAD EXHAU	11-11	P1,P2	45
56113				
BUICK REGAL	ALL	11-13	P1,P2	10
56114				
FORD FIESTA	SEDAN	11-13	P3,P4	10
56116				
CHEV IMPALA	ALL	00-05	P1,P2	10
56117				
INFINITI G37	CONVERTIBLE	10-10	P3,P4	30
56118				
HONDA ODYSSEY	ALL	11-17	S3	20
56119				
VOLVO C70	T5	11-13	P3,P4	45
56120				
FORD EDGE	EXCL ECOBOOST	11-14	S1,S2	45
FORD EDGE	ALL, INCL SPORT	11-14	S1,S2	45
56121				
LINC MKX	ALL	11-15	S3,S4	45
56123				
HONDA CR-Z	ALL	11-16	P3,P4	45
56124				
NISSAN JUKE	ALL	11-16	S3,S4	20
56126				
HYUNDAI ELANTRA	COUPE	11-12	P3,P4	20
HYUNDAI ELANTRA	SEDAN	11-15	P3,P4	20
HYUNDAI ELANTRA	SDN, EXCL LMTD	16-16	P3,P4	20
56127				
MITSU LANCER	ALL	16-16	P1,P3	45
MITSU LANCER	DE	12-13	P1,P3	45
MITSU LANCER	ES	12-17	P1,P3	45
MITSU LANCER	ES SPORTBACK	11-14	P1,P3	45
MITSU LANCER	GT	12-16	P1,P3	45
MITSU LANCER	GT SPORTBACK	12-14	P1,P3	45
MITSU LANCER	GTS SPORTBACK	10-11	P1,P3	45
MITSU LANCER	SE	12-17	P1,P3	45
MITSU LANCER	SEL	16-17	P1,P3	45
MITSU OUTLDR SPR	WITH LED TAILS	11-17	P1,P3	45
MITSU RVR	ALL	11-12	P1,P3	45
56129				
JEEP COMPASS	ALL	11-16	S1,S2	45
56131				
KIA FORTE	HATCH	11-13	P3,P4	20
56133				
DODGE DURANGO	ALL	11-13	S1,S2	10
56135				
DODGE CHARGER	ALL	11-14	P1,P2	25
56136				
SCION XD	W/O LED TAILS	08-14	P3,P4	20
56137				
NISSAN QUEST	ALL	11-18	S1,S2	45
56138				
FORD FOCUS	SEDAN	12-17	P3,P4	45
56139				
MAZDA 6	EXCL MZDASPD	09-13	P3,P4	25
56140				
FORD FOCUS	HATCH	13-14	P1,P2	45
FORD FOCUS	HATCH, EXCL ELEC	12-12	P1,P2	45

Make / Model	Style	Years	Loc	Ins
56142				
LEXUS IS250	ALL	09-15	P3,P4	40
LEXUS IS350	ALL	09-16	P3,P4	40
56145				
CHRY 300	ALL	11-14	P3,P4	15
56147				
TOYOTA PRIUS	ALL	04-11	P3,P4	30
TOYOTA PRIUS	SEDAN	12-15	P3,P4	30
56148				
NISSAN NV1500	ALL	12-17	S3,S4	45
NISSAN NV2500	ALL	12-17	S3,S4	45
NISSAN NV3500	ALL	12-17	S3,S4	45
56149				
HYUNDAI ACCENT	SEDAN	12-17	P3,P4	20
56150				
CHRY TOWN & CNTRY	ALL	11-16	S1,S2	45
DODGE GRND CARAVAN	ALL	11-17	S1,S2	45
56152				
HYUNDAI SANTA FE	SUV	07-12	S5	20
56153				
HYUNDAI VELOSTER	ALL	12-16	S1,S2	45
56154				
DODGE JOURNEY	LED TAIL LIGHTS	11-17	S1,S2	45
56155				
CHEV SONIC	ALL	12-15	P3,P4	45
56156				
TOYOTA PRIUS V	ALL	12-17	P3,P4	45
56157				
KIA RIO	ALL	12-14	P3,P4	20
KIA RIO	SEDAN	15-17	P3,P4	20
56158				
HONDA CR-V	ALL	12-16	S3	30
56159				
LAND ROVER RR EVQUE	ALL	12-14	S6	5
56160				
FORD EDGE	ALL	07-08	S3,S4	45
FORD EDGE	EXCL ECOBOOST	09-10	S3,S4	45
FORD EDGE	ALL, INCL SPORT	09-10	S3,S4	45
FORD ESCAPE	ALL, INCL HYBRID	08-12	S3,S4	45
FORD FREESTAR	ALL	04-07	S3,S4	45
LINC MKX	ALL	07-10	S3,S4	45
MAZDA TRIBUTE	ALL	08-11	S3,S4	45
MERC MARINER	ALL	05-10	S3,S4	45
MERC MARINER	ALL	05-11	S3,S4	45
56161				
HONDA ODYSSEY	ALL	05-10	S4	15
56163				
KIA SORENTO	ALL	11-13	S1,S2	45
KIA SORENTO	EXCL SX	11-13	S1,S2	45
56164				
FORD ESCAPE	ALL	13-16	S1,S2	45
56165				
TOYOTA RAV4	ALL	06-12	S3,S4	45
56166				
TOYOTA AVALON	HYBRID LTD	13-18	P3,P4	45
TOYOTA AVALON	HYBRID XLE	13-14	P3,P4	45
TOYOTA AVALON	HYBRID XLE PLUS	16-18	P3,P4	45
TOYOTA AVALON	HYBRID XLE PREM	15-18	P3,P4	45
TOYOTA AVALON	HYBRID XLE TOUR	15-15	P3,P4	45
TOYOTA AVALON	LTD	13-18	P3,P4	45
TOYOTA AVALON	TOURING	16-18	P3,P4	45
TOYOTA AVALON	XLE	13-18	P3,P4	45
TOYOTA AVALON	XLE PLUS	16-18	P3,P4	45
TOYOTA AVALON	XLE PREMIUM	15-18	P3,P4	45
TOYOTA AVALON	XLE TOURING	15-15	P3,P4	45
TOYOTA AVALON	XLE TOURING SE	15-15	P3,P4	45
TOYOTA CAMRY	ALL	18-18	P3,P4	45
TOYOTA RAV4	ALL	13-17	P3,P4	45
56170				
HONDA PILOT	ALL	12-15	S5	20
56171				
HYUNDAI AZERA	ALL	12-17	P3,P4	45
56172				
FORD EXPLORER	ALL	11-17	T3	10
FORD POLICE INTRCPTR	ALL	13-17	T3	10
56173				
HONDA ACCORD	HYBRID	17-17	P3,P4	45
HONDA ACCORD	WITH LED TAILS	13-15	P3,P4	45

Make / Model	Style	Years	Loc	Ins
56174				
FIAT 500	ALL	12-17	P1,P2	45
56176				
CHEV MALIBU	ECO	13-14	P3,P4	45
CHEV MALIBU	LS	13-15	P3,P4	45
CHEV MALIBU	LT	13-15	P3,P4	45
CHEV MALIBU LTD	LS	16-16	P3,P4	45
CHEV MALIBU LTD	LT	16-16	P3,P4	45
56177				
CHEV MALIBU	LTZ	13-15	P3,P4	45
CHEV MALIBU LTD	LTZ	16-16	P3,P4	45
56178				
FORD FUSION	ENERGI SE	13-13	P3,P4	45
FORD FUSION	ENERGI SE LUXRY	14-15	P3,P4	45
FORD FUSION	S	13-15	P3,P4	45
FORD FUSION	S HYBRID	14-15	P3,P4	45
FORD FUSION	SE	13-15	P3,P4	45
FORD FUSION	SE HYBRID	13-15	P3,P4	45
56179				
DODGE DART	ALL	13-16	P3,P4	45
56180				
CADILLAC ATS	ALL	13-17	P3,P4	45
56181				
CHEV TRAVERSE	ALL	13-17	P3,P4	45
56182				
LEXUS LS460	SEDAN	12-12	P3,P4	40
56183				
DODGE NITRO	ALL	07-12	S1,S2	45
JEEP LIBERTY	ALL	08-12	S1,S2	45
56184				
HYUNDAI SANTA FE	GLS	13-15	S1,S2	45
HYUNDAI SANTA FE	LTD ULTIMATE	17-17	S1,S2	45
HYUNDAI SANTA FE	LTD	13-17	S1,S2	45
HYUNDAI SANTA FE	SE ULTIMATE	17-17	S1,S2	45
HYUNDAI SANTA FE	SE	16-17	S1,S2	45
HYUNDAI SANTA FE	SPORT 2.0T	13-18	S1,S2	45
HYUNDAI SANTA FE	SPORT 2.0T ULT	17-18	S1,S2	45
HYUNDAI SANTA FE	SPORT	13-17	S1,S2	45
KIA BORREGO	ALL	09-09	S1,S2	45
56185				
NISSAN VERSA	1.6 S PLUS SEDAN	14-17	P1,P2	20
NISSAN VERSA	1.6 S, SEDAN	14-17	P1,P2	20
NISSAN VERSA	1.6 SL, SEDAN	14-16	P1,P2	20
NISSAN VERSA	1.6 SV, SEDAN	14-17	P1,P2	20
56186				
KIA FORTE	ALL	14-17	P3,P4	20
KIA FORTE KOUP	ALL	14-16	P3,P4	20
56188				
CHEV IMPALA	ALL	14-18	P3,P4	45
56189				
MITSU OUTLANDER	ALL	14-17	S3,S4	45
56191				
FORD FIESTA	HATCH	14-17	P3,P4	20
56192				
ACURA MDX	ALL	14-17	S3	15
56193				
FIAT 500L	ALL	14-17	P1,P2	45
56197				
CHEV CAMARO	W/O LED TAILS	14-15	P1,P2	15
56199				
KIA CADENZA	ALL	14-16	P3,P4	30
56204				
MAZDA 3	WITH LED TAILS	14-18	P3,P4	45
56205				
NISSAN SENTRA	ALL	13-17	P3,P4	45
56206				
NISSAN VERSA NOTE	ALL	14-17	P3,P4	30
56207				
CADILLAC CTS	ALL	16-17	P3,P4	45
CADILLAC CTS	BASE, SEDAN	14-15	P3,P4	45
CADILLAC CTS	LUXURY, SEDAN	14-15	P3,P4	45
CADILLAC CTS	PERFORM, SEDAN	14-15	P3,P4	45
CADILLAC CTS	PREMIUM, SEDAN	14-15	P3,P4	45

Make / Model	Style	Years	Loc	Ins
56208				
JEEP CHRKEE	75TH ANNIV	16-16	P3,P4	45
JEEP CHRKEE	LATITUDE	14-18	P3,P4	45
JEEP CHRKEE	LTD	14-18	P3,P4	45
JEEP CHRKEE	OVERLAND	16-18	P3,P4	45
JEEP CHRKEE	SPORT	14-18	P3,P4	45
JEEP CHRKEE	TRAILHAWK	14-18	P3,P4	45
56209				
RAM PROMSTR 1500	ALL	14-17	S3,S4	45
RAM PROMSTR 2500	ALL	14-17	S3,S4	45
RAM PROMSTR 3500	ALL	14-17	S3,S4	45
56210				
CHEV EQUINOX	ALL	10-17	S3	20
GMC TERRAIN	ALL	10-17	S3	20
56211				
CHRY 200	ALL	11-14	P1,P2	45
DODGE AVENGER	ALL	11-14	P1,P2	45
56212				
SCION FR-S	ALL	13-16	P3,P4	45
SUBA BRZ	ALL	13-17	P3,P4	45
SUBA IMPREZA	SEDAN	17-17	P3,P4	45
56213				
ACURA RLX	ALL	14-17	P3,P4	45
56214				
CHEV CRUZE	ALL	11-15	P3,P4	20
CHEV CRUZE LTD	ALL	16-16	P3,P4	20
56215				
HONDA CROSSTOUR	ALL	13-15	S4	30
56216				
BUICK ENCORE	ALL	13-16	S3,S4	45
56217				
TOYOTA HIGHLANDER	ALL	08-17	S8	30
56218				
FORD TRANSIT CNNCT	ALL	14-17	S3,S4	45
56219				
HONDA CIVIC	SEDAN, HYBRID	13-15	P3,P4	45
56220				
KIA RONDO	ALL	07-12	S1,S2	30
KIA SOUL	!	10-18	S1,S2	30
KIA SOUL	+	10-18	S1,S2	30
KIA SOUL	BASE	10-18	S1,S2	30
KIA SOUL	SPORT	10-11	S1,S2	30
56222				
KIA RONDO	ALL	07-12	S1,S2	15
KIA SOUL	W/O LED TAILS	10-17	S1,S2	15
56223				
MITSU MIRAGE	ALL	14-17	P3,P4	20
MITSU MIRAGE G4	ALL	17-17	P3,P4	20
56224				
VOLVO S60	ALL	14-16	P3,P4	45
VOLVO S60	T5 DYNAMIC	17-17	P3,P4	45
VOLVO S60	T5 INSCRIPTION	17-17	P3,P4	45
56225				
NISSAN FRONTIER	ALL	05-17	S5,T3	30
NISSAN PATHFINDER	ALL	05-12	S5,T3	30
NISSAN XTERRA	ALL	05-15	S5,T3	30
SUZUKI EQUATOR	ALL	09-12	S5,T3	30
56226				
NISSAN FRONTIER	ALL	05-17	S5	30
NISSAN PATHFINDER	ALL	05-12	S5	30
NISSAN XTERRA	ALL	05-15	S5	30
SUZUKI EQUATOR	ALL	09-12	S5	30
56227				
NISSAN LEAF	ALL	11-17	P3,P4	45
56228				
KIA FORTE5	ALL	14-17	P3,P4	20
56230				
DODGE CHALLENGER	SCAT PACK SHAKR	16-16	P3,P4	45
DODGE CHALLENGER	GT	17-18	P3,P4	45
DODGE CHALLENGER	R/T	15-18	P3,P4	45
DODGE CHALLENGER	R/T 392	17-18	P3,P4	45
DODGE CHALLENGER	R/T PLUS	15-16	P3,P4	45
DODGE CHALLENGER	R/T PLUS SHAKER	16-16	P3,P4	45
DODGE CHALLENGER	R/T SCAT PACK	16-16	P3,P4	45
DODGE CHALLENGER	R/T SHAKER	16-16	P3,P4	45
DODGE CHALLENGER	SCAT PACK	15-15	P3,P4	45
DODGE CHALLENGER	SRT 392	15-18	P3,P4	45

Make / Model	Style	Years	Loc	Ins
DODGE CHALLENGER	SRT DEMON	18-18	P3,P4	45
DODGE CHALLENGER	SRT HELLCAT	15-18	P3,P4	45
DODGE CHALLENGER	SXT	15-18	P3,P4	45
DODGE CHALLENGER	SXT PLUS	15-16	P3,P4	45
DODGE CHALLENGER	T/A	17-17	P3,P4	45
DODGE CHALLENGER	T/A 392	17-17	P3,P4	45
56231				
ACURA TL	ALL	04-08	P3,P4	10
56233				
HYUNDAI ELANTRA	ECO	17-17	P3,P4	45
HYUNDAI ELANTRA	SE	17-17	P3,P4	45
HYUNDAI ELANTRA GT	ALL	14-17	P3,P4	45
56234				
DODGE CHARGER	DAYTONA	17-17	P3,P4	45
DODGE CHARGER	DAYTONA 392	17-17	P3,P4	45
DODGE CHARGER	PURSUIT	15-18	P3,P4	45
DODGE CHARGER	R/T	15-17	P3,P4	45
DODGE CHARGER	R/T 392	17-18	P3,P4	45
DODGE CHARGER	ROAD & TRACK	15-16	P3,P4	45
DODGE CHARGER	R/T SCAT PACK	15-16	P3,P4	45
DODGE CHARGER	SE	15-18	P3,P4	45
DODGE CHARGER	SRT 392	15-18	P3,P4	45
DODGE CHARGER	SRT HELLCAT	15-18	P3,P4	45
DODGE CHARGER	SXT	15-18	P3,P4	45
56235				
CHRY 300	C	15-18	P3,P4	45
CHRY 300	C PLATINUM	15-18	P3,P4	45
CHRY 300	LTD	15-18	P3,P4	45
CHRY 300	TOURING	18-18	P3,P4	45
56241				
HYUNDAI SONATA	HYBRID	11-15	P3,P4	30
HYUNDAI SONATA	HYBRID LTD	13-15	P3,P4	30
56242				
CHRY 200	ALL	15-17	P3,P4	45
56243				
SUBA CROSSTREK	HYBRID	16-16	S1,S2	45
SUBA CROSSTREK	HYBRID TOURING	16-16	S1,S2	45
SUBA XV CROSSTREK	HYBRID	14-15	S1,S2	45
SUBA XV CROSSTREK	HYBRID TOURING	14-15	S1,S2	45
56245				
BUICK ENCLAVE	ALL	13-17	S3	20
CHEV TRAVERSE	ALL	13-17	S3	20
GMC ACADIA	ALL	13-16	S3	20
GMC ACADIA LTD	ALL	17-17	S3	20
56246				
SUBA LEGACY	2.5I	15-18	P3,P4	45
SUBA LEGACY	2.5I LTD	15-18	P3,P4	45
SUBA LEGACY	2.5I PREMIUM	15-18	P3,P4	45
SUBA LEGACY	2.5I SPORT	18-18	P3,P4	45
SUBA LEGACY	2.5I TOURING	16-17	P3,P4	45
SUBA LEGACY	3.6R LTD	15-18	P3,P4	45
56247				
HYUNDAI SONATA	ECO	15-17	P3,P4	20
HYUNDAI SONATA	LTD	15-16	P3,P4	20
HYUNDAI SONATA	LTD 2.0T	15-17	P3,P4	20
HYUNDAI SONATA	SE	15-17	P3,P4	20
HYUNDAI SONATA	SPORT	15-17	P3,P4	20
HYUNDAI SONATA	SPORT 2.0T	15-17	P3,P4	20
56248				
INFINITI Q50	ALL	14-17	P3,P4	45
56249				
FORD TRANSIT-150	ALL	15-17	S1,S2	45
FORD TRANSIT-250	ALL	15-17	S1,S2	45
56250				
BUICK VERANO	ALL	12-15	P3,P4	20
56251				
KIA SPORTAGE	ALL	11-16	S1,S5	45
56252				
HYUNDAI ELANTRA	COUPE	13-15	P3,P4	45
56253				
CHEV CAMARO	ALL	12-13	P1,P2	45
56254				
HYUNDAI ACCENT	HATCH	13-17	P3,P4	20
56255				
BUICK REGAL	ALL	14-17	P1,P2	45
56256				
KIA SORENTO	EX, 2.0L	14-18	S1,S2	45
KIA SORENTO	LTD, 2.0L	14-18	S1,S2	45

Make / Model	Style	Years	Loc	Ins
56257				
CHEV CAPTIVA SPORT	ALL	13-15	S3,S4	45
56258				
LINC MKZ	ALL	13-17	S3,S4	30
56259				
SUBA IMPREZA	BASE, SEDAN	12-16	P3,P4	45
SUBA IMPREZA	LTD, SEDAN	12-16	P3,P4	45
SUBA IMPREZA	PREMIUM, SEDAN	12-16	P3,P4	45
SUBA WRX	ALL	15-17	P3,P4	45
56261				
TOYOTA SIENNA	L	15-17	S1,S2	45
TOYOTA SIENNA	LE	15-17	S1,S2	45
TOYOTA SIENNA	LTD	15-17	S1,S2	45
TOYOTA SIENNA	XLE	15-17	S1,S2	45
56262				
LINC MKC	ALL	15-17	S3,S4	40
56263				
LEXUS GS350	ALL	13-16	P3,P4	45
LEXUS GS450H	ALL	13-15	P3,P4	45
56264				
GENESIS G80	ALL	17-17	P3,P4	45
HYUNDAI GENESIS	ALL	15-16	P3,P4	45
56267				
NISSAN MURANO	ALL	15-17	S3,S4	30
56268				
LEXUS NX200T	ALL	15-17	S3,S4	45
LEXUS NX300H	ALL	15-17	S3,S4	45
56269				
ACURA ILX	ALL	13-17	P1,P2	45
56270				
RAM PROMSTR CITY	ALL	15-17	S3,S4	45
56272				
FORD EDGE	SE	15-17	S1,S2	45
FORD EDGE	SEL	15-17	S1,S2	45
56273				
FORD FOCUS	HATCH	15-17	P1,P2	45
56274				
JEEP RENEGADE	ALL	15-17	S3,S4	45
56275				
TOYOTA PRIUS C	FOUR	12-18	P3,P4	45
TOYOTA PRIUS C	ONE	12-18	P3,P4	45
TOYOTA PRIUS C	PERSONA SERIES	16-16	P3,P4	45
TOYOTA PRIUS C	THREE	12-18	P3,P4	45
TOYOTA PRIUS C	TWO	12-18	P3,P4	45
56277				
HYUNDAI TUCSON	ALL	10-17	S1,S2	45
56278				
FORD EXPLORER	ALL	11-15	S1,S2	20
56279				
CHEV CITY EXPRESS	ALL	15-17	S3,S4	45
NISSAN NV200	ALL	13-17	S3,S4	45
56280				
MAZDA 6	ALL	14-17	P3,P4	45
56281				
INFINITI QX60	ALL	14-17	S3,S5	30
NISSAN PATHFINDER	ALL	13-17	S3,S5	30
56282				
TOYOTA TACOMA	ALL	16-17	T1,T2	45
56283				
HYUNDAI ELANTRA	SEDAN, LTD	16-16	P3,P4	45
56284				
HONDA HR-V	EX	16-18	S3,S4	45
HONDA HR-V	EX-L	16-18	S3,S4	45
HONDA HR-V	LX	16-18	S3,S4	45
56285				
VOLVO S90	ALL	17-17	S3,S4	30
VOLVO XC90	T5 INSCRIPTION	16-16	S3,S4	30
VOLVO XC90	T5 MOMENTUM	16-18	S3,S4	30
VOLVO XC90	T5 R-DESIGN	16-18	S3,S4	30
VOLVO XC90	T6 FIRST EDITION	16-16	S3,S4	30
VOLVO XC90	T6 INSCRIPTION	16-18	S3,S4	30
VOLVO XC90	T6 MOMENTUM	16-18	S3,S4	30
VOLVO XC90	T6 R-DESIGN	16-18	S3,S4	30
VOLVO XC90	T8 EXCELLENCE	17-18	S3,S4	30
VOLVO XC90	T8 INSCRIPTION	16-18	S3,S4	30
VOLVO XC90	T8 MOMENTUM	16-18	S3,S4	30
VOLVO XC90	T8 R-DESIGN	16-18	S3,S4	30

Make / Model	Style	Years	Loc	Ins
56287				
VOLVO V60	T5	15-17	S3,S4	45
VOLVO V60	T5 PLATINUM	15-17	S3,S4	45
VOLVO V60	T5 PREMIER	15-17	S3,S4	45
VOLVO V60	T5 PREMIER PLUS	15-15	S3,S4	45
56288				
BUICK VERANO	ALL	12-17	P3,P4	45
56291				
HONDA PILOT	ALL	16-17	S5	20
56292				
FORD EDGE	SPORT	15-17	S1,S2	45
FORD EDGE	TITANIUM	15-17	S1,S2	45
56293				
LAND ROVER RR SPRT	ALL	15-17	S6	5
56294				
NISSAN MAXIMA	ALL	16-17	P3,P4	45
56295				
KIA RIO	HATCH	12-16	P3,P4	25
56296				
MITSU OUTLANDER	ALL	16-16	S4	25
56297				
LAND ROVER DISC SPT	ALL	15-16	S1,S2	45
56298				
LINC MKX	ALL	16-17	S1,S2	45
56299				
HONDA ACCORD	SEDAN	16-17	P3,P4	45
56300				
MAZDA CX-3	GRAND TOURING	16-18	P3,P4	45
MAZDA CX-3	SPORT	16-18	P3,P4	45
MAZDA CX-3	TOURING	16-18	P3,P4	45
MAZDA MX-5 MIATA	ALL	16-17	P3,P4	45
56301				
HONDA ACCORD	COUPE	16-17	P3,P4	45
56302				
FORD FUSION	ENERGI PLATINM	17-18	P3,P4	45
FORD FUSION	ENERGI SE LUXRY	16-18	P3,P4	45
FORD FUSION	ENERGI TITANIUM	16-18	P3,P4	45
FORD FUSION	PLATINUM	17-18	P3,P4	45
FORD FUSION	PLATINUM HYBRD	17-18	P3,P4	45
FORD FUSION	S	16-18	P3,P4	45
FORD FUSION	S HYBRID	16-17	P3,P4	45
FORD FUSION	SE	16-17	P3,P4	45
FORD FUSION	SE HYBRID	16-17	P3,P4	45
FORD FUSION	SPORT	17-17	P3,P4	45
FORD FUSION	TITANIUM	16-17	P3,P4	45
FORD FUSION	TITANIUM HYBRID	16-17	P3,P4	45
56303				
CHEV SONIC	LS, HATCH	12-16	P3,P4	45
CHEV SONIC	LS, SEDAN	12-16	P3,P4	45
CHEV SONIC	LT, HATCH	12-16	P3,P4	45
CHEV SONIC	LT, SEDAN	12-16	P3,P4	45
CHEV SONIC	LTZ, HATCH	12-16	P3,P4	45
CHEV SONIC	LTZ, SEDAN	12-16	P3,P4	45
CHEV SONIC	RS, HATCH	13-16	P3,P4	45
CHEV SONIC	RS, SEDAN	15-16	P3,P4	45
56305				
NISSAN MURANO	S, SPORT UTIL	06-07	S3,S4	45
NISSAN MURANO	SE, SPORT UTIL	06-07	S3,S4	45
NISSAN MURANO	SL, SPORT UTIL	06-07	S3,S4	45
56306				
FORD EXPLORER	ALL	11-17	S7	20
FORD POL INT UTILITY	ALL	13-17	S7	20
56307				
FORD F-150	KING RANCH	15-18	T4	20
FORD F-150	LARIAT	15-18	T4	20
FORD F-150	LTD	16-18	T4	20
FORD F-150	PLATINUM	15-18	T4	20
FORD F-150	RAPTOR	17-18	T4	20
FORD F-150	SSV	16-18	T4	20
FORD F-150	XL	15-18	T4	20
FORD F-150	XLT	15-18	T4	20
56308				
FIAT 500X	ALL	16-17	P1,P2	45
56309				
SCION IM	ALL	16-16	S1,S2	45
TOYOTA COROLLA IM	ALL	17-17	S1,S2	45

Make / Model	Style	Years	Loc	Ins
56310				
MAZDA CX-5	ALL	16-16	S1,S2	45
56311				
SCION IA	ALL	16-16	S3,S4	45
TOYOTA YARIS IA	ALL	17-17	S3,S4	45
56312				
CHEV MALIBU	L	16-17	P3,P4	45
CHEV MALIBU	LS	16-17	P3,P4	45
CHEV MALIBU	LT	16-17	P3,P4	45
56313				
CHEV MALIBU	PREMIER	16-18	P3,P4	45
56314				
KIA OPTIMA	EX	12-18	P3,P4	45
KIA OPTIMA	HYBRID	11-16	P3,P4	45
KIA OPTIMA	HYBRID EX	13-17	P3,P4	45
KIA OPTIMA	HYBRID LX	13-15	P3,P4	45
KIA OPTIMA	HYBRID PREMIUM	17-17	P3,P4	45
KIA OPTIMA	LTD	14-15	P3,P4	45
KIA OPTIMA	LX	11-18	P3,P4	45
KIA OPTIMA	LX 1.6T	16-18	P3,P4	45
KIA OPTIMA	PLUG-IN HYBRD EX	17-17	P3,P4	45
KIA OPTIMA	SX	11-18	P3,P4	45
KIA OPTIMA	SX LTD	16-18	P3,P4	45
KIA OPTIMA	SX TURBO	14-15	P3,P4	45
KIA OPTIMA	SXL	13-13	P3,P4	45
56315				
CHEV VOLT	LT	16-18	P1,P2	45
CHEV VOLT	PREMIER	16-18	P1,P2	45
56316				
HYUNDAI ELANTRA	LTD	17-17	P3,P4	45
56317				
TOYOTA PRIUS	THREE	16-16	P3,P4	45
TOYOTA PRIUS	THREE TOURING	16-16	P3,P4	45
TOYOTA PRIUS	TWO	16-16	P3,P4	45
TOYOTA PRIUS	TWO ECO	16-16	P3,P4	45
56318				
CHEV CAMARO	LS	18-18	P3,P4	45
CHEV CAMARO	LT	16-18	P3,P4	45
CHEV CAMARO	SS	16-18	P3,P4	45
CHEV CAMARO	ZL1	17-18	P3,P4	45
56319				
CHEV CRUZE	ALL	16-16	P3,P4	45
CHEV CRUZE	SEDAN	17-17	P3,P4	45
56320				
FORD ESCAPE	S	17-18	S1,S2	60
FORD ESCAPE	SE	17-18	S1,S2	60
FORD ESCAPE	SEL	18-18	S1,S2	60
FORD ESCAPE	TITANIUM	17-18	S1,S2	60
56321				
KIA SPORTAGE	EX	17-18	S1,S5	60
KIA SPORTAGE	LX	17-18	S1,S5	60
KIA SPORTAGE	SX TURBO	17-18	S1,S5	60
56322				
CHRY PACIFICA	HYBRID PLATNM	18-18	S1,S2	
CHRY PACIFICA	HYBRID PREMIUM	18-18	S1,S2	
CHRY PACIFICA	LTD	17-17	S1,S2	
CHRY PACIFICA	TOURING L	17-17	S1,S2	
CHRY PACIFICA	TOURING L PLUS	17-17	S1,S2	
56323				
CADILLAC CT6	BASE	16-18	P3,P4	45
CADILLAC CT6	LUXURY	16-18	P3,P4	45
CADILLAC CT6	PLATINUM	16-18	P3,P4	45
CADILLAC CT6	PLUG-IN	17-18	P3,P4	45
CADILLAC CT6	PREMIUM LUXURY	16-18	P3,P4	45
56324				
HONDA CIVIC	COUPE	16-17	P3,P4	10
56325				
CADILLAC XT5	BASE	17-18		10
CADILLAC XT5	LUXURY	17-18		10
CADILLAC XT5	PLATINUM	17-18		10
CADILLAC XT5	PREMIUM LUXURY	17-18		10
GMC ACADIA	DENALI	17-18		10
GMC ACADIA	SL	17-18		10
GMC ACADIA	SLE	17-18		10
GMC ACADIA	SLT	17-18		10

Make / Model	Style	Years	Loc	Ins
56326				
CADILLAC XT5	BASE	17-18		
CADILLAC XT5	LUXURY	17-18		
CADILLAC XT5	PLATINUM	17-18		
CADILLAC XT5	PREMIUM LUXURY	17-18		
GMC ACADIA	DENALI	17-18		
GMC ACADIA	SL	17-18		
GMC ACADIA	SLE	17-18		
GMC ACADIA	SLT	17-18		
56327				
FORD TRANSIT-150	ALL	15-17	S1,S2	45
FORD TRANSIT-250	ALL	15-17	S1,S2	45
56328				
KIA SORENTO	BASE	11-12	S1,S2	45
KIA SORENTO	EX	11-13	S1,S2	45
KIA SORENTO	LX	11-13	S1,S2	45
56329				
FORD EDGE	ALL	07-10	S3,S4	45
FORD ESCAPE	ALL	08-12	S3,S4	45
FORD FREESTAR	ALL	04-07	S3,S4	45
LINC MKX	ALL	07-10	S3,S4	45
MAZDA TRIBUTE	ALL	08-11	S3,S4	45
MERC MARINER	ALL	05-11	S3,S4	45
56330				
DODGE JOURNEY	WITH LED TAILS	11-17	S1,S2	45
56331				
CHRY TOWN & CNTRY	ALL	11-16	S1,S2	45
DODGE GRND CARAVAN	ALL	11-17	S1,S2	45
56332				
HYUNDAI SANTA FE	W/ FACT TOW PKG	13-18	S5	20
HYUNDAI VERACRUZ	W/ FACT TOW PKG	07-12	S5	20
KIA SEDONA	W/ FACT TOW PKG	15-16	S5	20
KIA SORENTO	W/ FACT TOW PKG	07-18	S5	20
56333				
CHRY TOWN & CNTRY	ALL	08-10	S1,S2	30
DODGE CALIBER	ALL	08-12	S1,S2	30
DODGE DURANGO	ALL	11-13	S1,S2	30
DODGE GRND CARAVAN	ALL	08-10	S1,S2	30
JEEP PATRIOT	ALL	08-17	S1,S2	30
56334				
DODGE NITRO	ALL	07-12	S1,S2	15
JEEP LIBERTY	ALL	08-12	S1,S2	15
56335				
FORD ESCAPE	S	13-16	S1,S2	45
FORD ESCAPE	SE	13-16	S1,S2	45
FORD ESCAPE	SEL	13-13	S1,S2	45
FORD ESCAPE	TITANIUM	13-16	S1,S2	45
56336				
DODGE DURANGO	CITADEL	14-18	S1,S2	30
DODGE DURANGO	GT	17-18	S1,S2	30
DODGE DURANGO	LTD	16-16	S1,S2	30
DODGE DURANGO	R/T	14-18	S1,S2	30
DODGE DURANGO	RALLYE	14-15	S1,S2	30
DODGE DURANGO	SPECIAL SERVICE	14-18	S1,S2	30
DODGE DURANGO	SRT	18-18	S1,S2	30
DODGE DURANGO	SXT	14-18	S1,S2	30
56338				
MAZDA CX-9	ALL	16-17	S4	45
56339				
NISSAN ALTIMA	ALL	16-17	P3,P4	45
56340				
BUICK LACROSSE	CX	05-09	P1,P2	10
BUICK LACROSSE	CXL	05-09	P1,P2	10
56341				
HONDA CIVIC	SEDAN	01-05	P3,P4	45
56343				
FORD FLEX	ALL	09-18	P3,P4	45
56344				
JEEP COMPASS	ALL	11-16	S1,S2	45
56345				
FORD ESCAPE	ALL	05-07	S1,S2	45
MAZDA TRIBUTE	ALL	05-06	S1,S2	45
56346				
HYUNDAI SANTA FE	GLS	07-12	S5	20
HYUNDAI SANTA FE	LTD	07-12	S5	20
HYUNDAI SANTA FE	SE	07-12	S5	20

Make / Model	Style	Years	Loc	Ins
56347				
HYUNDAI ENTOURAGE	ALL	07-09	S1,S2	45
KIA SEDONA	ALL	06-14	S1,S2	45
56348				
HYUNDAI TUCSON	ECO	16-17	S1,S2	45
HYUNDAI TUCSON	FUEL CELL	15-16	S1,S2	45
HYUNDAI TUCSON	GL	11-13	S1,S2	45
HYUNDAI TUCSON	GLS	10-15	S1,S2	45
HYUNDAI TUCSON	LTD	10-17	S1,S2	45
HYUNDAI TUCSON	SE	14-17	S1,S2	45
HYUNDAI TUCSON	SPORT	16-17	S1,S2	45
56349				
TOYOTA TACOMA	ALL	16-17	T1,T2	45
56350				
TOYOTA AVALON	HYBRID LTD	13-18	S3,S4	45
TOYOTA AVALON	HYBRID XLE	13-14	S3,S4	45
TOYOTA AVALON	HYBRID XLE PLUS	16-18	S3,S4	45
TOYOTA AVALON	HYBRID XLE PREM	15-18	S3,S4	45
TOYOTA AVALON	HYBRID XLE TOUR	15-15	S3,S4	45
TOYOTA AVALON	LTD	13-18	S3,S4	45
TOYOTA AVALON	TOURING	16-18	S3,S4	45
TOYOTA AVALON	XLE	13-18	S3,S4	45
TOYOTA AVALON	XLE PLUS	16-18	S3,S4	45
TOYOTA AVALON	XLE PREMIUM	15-18	S3,S4	45
TOYOTA AVALON	XLE TOURING	15-15	S3,S4	45
TOYOTA AVALON	XLE TOURING SE	15-15	S3,S4	45
TOYOTA CAMRY	ALL	18-18	S3,S4	45
TOYOTA RAV4	ALL	13-17	S3,S4	45
56351				
FORD FUSION	ENERGI PLATNM	17-18	P3,P4	45
FORD FUSION	ENERGI SE	13-13	P3,P4	45
FORD FUSION	ENERGI SE LUXRY	14-18	P3,P4	45
FORD FUSION	ENERGI TITANIUM	13-18	P3,P4	45
FORD FUSION	PLATINUM	17-18	P3,P4	45
FORD FUSION	PLATINUM HYBRD	17-18	P3,P4	45
FORD FUSION	S	13-18	P3,P4	45
FORD FUSION	S HYBRID	14-17	P3,P4	45
FORD FUSION	SE	13-17	P3,P4	45
FORD FUSION	SE HYBRID	13-17	P3,P4	45
FORD FUSION	SPORT	17-17	P3,P4	45
FORD FUSION	TITANIUM	13-17	P3,P4	45
FORD FUSION	TITANIUM HYBRID	13-17	P3,P4	45
56353				
TOYOTA PRIUS	ALL	16-17	P3,P4	45
56354				
CHEV CRUZE	LT, HATCH	17-17	P1,P2	45
CHEV CRUZE	PREMIER, HATCH	17-17	P1,P2	45
56355				
VOLVO XC60	ALL	10-16	S3,S4	45
VOLVO XC60	TURBOCHARGED	17-17	S3,S4	45
56356				
BUICK LACROSSE	ALL	17-17	P1,P2	45
56357				
INFINITI QX60	ALL	14-17	S3,S5	30
NISSAN PATHFINDER	ALL	13-17	S3,S5	30
56358				
VOLKSWAGEN TIGUAN	S	12-17	S1,S2	45
VOLKSWAGEN TIGUAN	SE	12-16	S1,S2	45
VOLKSWAGEN TIGUAN	SEL	12-17	S1,S2	45
VOLKSWAGEN TIGUAN	SPORT	17-17	S1,S2	45
VOLKSWAGEN TIGUAN	WOLFSBURG EDTN	17-17	S1,S2	45
56359				
LINC CONTINENTAL	ALL	17-17	S3,S4	45
56360				
VW GOLF ALLTRACK	ALL	17-17	S1,S2	45
56362				
HYUNDAI SONATA	HYBRID	16-16	P3,P4	30
HYUNDAI SONATA	HYBRID LTD	16-17	P3,P4	30
56363				
BUICK ENCORE	ALL	17-17	S3,S4	45
56364				
BUICK ENVISION	ALL	16-17	S5	10
56365				
HONDA PILOT	ALL	09-11	S5	20
HONDA RIDGELINE	ALL	17-17	S5	20
56366				
HONDA PILOT	ALL	09-11	S5	20
HONDA RIDGELINE	ALL	17-17	S5	20

Make / Model	Style	Years	Loc	Ins
56367				
SUBA IMPREZA	BASE, HATCH	17-18	P1,P2	45
SUBA IMPREZA	LTD, HATCH	17-18	P1,P2	45
SUBA IMPREZA	PREMIUM, HATCH	17-18	P1,P2	45
SUBA IMPREZA	SPORT, HATCH	17-18	P1,P2	45
56368				
SUBA IMPREZA	WAGON	12-16	P1,P2	45
56370				
HONDA CR-V	AWD	17-17	S3	45
56371				
TOYOTA PRIUS PRIME	ALL	17-17	P3,P4	45
56373				
VOLKSWAGEN GOLF	ALL	15-17	P3,P4	45
VOLKSWAGEN GTI	ALL	17-17	P3,P4	45
56375				
CHEV EQUINOX	ALL	18-18	S6	20
56376				
KIA NIRO	ALL	17-17	P3,P4	45
56377				
MAZDA CX-5	ALL	17-17	S3,S4	45
56378				
HONDA ODYSSEY	EX	11-17	S3	20
HONDA ODYSSEY	EX-L	11-17	S3	20
HONDA ODYSSEY	LX	11-17	S3	20
HONDA ODYSSEY	SE	16-17	S3	20
HONDA ODYSSEY	TOURING	11-17	S3	20
HONDA ODYSSEY	TOURING ELITE	11-17	S3	20
56379				
INFINITI QX30	ALL	17-17	P3,P4	45
56381				
HYUNDAI IONIQ	HYBRID LTD	17-17	P3,P4	45
HYUNDAI IONIQ	HYBRID SEL	17-17	P3,P4	45
56382				
HONDA ODYSSEY	EX	18-18	S3	20
HONDA ODYSSEY	EX-L	18-18	S3	20
HONDA ODYSSEY	LX	18-18	S3	20
HONDA ODYSSEY	SE	18-18	S3	20
HONDA ODYSSEY	TOURING	18-18	S3	20
HONDA ODYSSEY	TOURING ELITE	18-18	S3	20
56384				
TOYOTA C-HR	XLE	18-18	P3,P4	45
TOYOTA C-HR	XLE PREMIUM	18-18	P3,P4	45
56385				
TOYOTA YARIS	L	15-17	P3,P4	45
TOYOTA YARIS	LE	15-17	P3,P4	45
TOYOTA YARIS	SE	15-17	P3,P4	45
56387				
CHEV MALIBU	HYBRID	16-18	P3,P4	45
CHEV MALIBU	L	16-18	P3,P4	45
CHEV MALIBU	LS	16-18	P3,P4	45
CHEV MALIBU	LT	16-18	P3,P4	45
56388				
VOLKSWAGEN PASSAT	R-LINE	16-17	P3,P4	45
VOLKSWAGEN PASSAT	S	16-17	P3,P4	45
56390				
HYUNDAI SONATA	ECO	18-18	P3,P4	30
HYUNDAI SONATA	HYBRID	16-17	P3,P4	30
HYUNDAI SONATA	HYBRID LTD	16-17	P3,P4	30
HYUNDAI SONATA	LTD	18-18	P3,P4	30
HYUNDAI SONATA	LTD 2.0T	18-18	P3,P4	30
HYUNDAI SONATA	SE	18-18	P3,P4	30
HYUNDAI SONATA	SEL	18-18	P3,P4	30
HYUNDAI SONATA	SPORT	18-18	P3,P4	30
HYUNDAI SONATA	SPORT 2.0T	18-18	P3,P4	30
56510				
CHEV COLORADO	ALL	04-12	T3	10
GMC CANYON	ALL	06-06	T3	10
GMC CANYON	PICKUP	04-12	T3	10
ISUZU I-280	ALL	06-08	T3	10
ISUZU I-290	ALL	07-08	T3	10
ISUZU I-350	ALL	06-08	T3	10
ISUZU I-370	ALL	07-08	T3	10
56513				
TOYOTA HILUX	ALL	08-12	T3,T5	10
TOYOTA T100	ALL	93-98	T3,T5	10
TOYOTA TACOMA	ALL	05-15	T3,T5	10

Make / Model	Style	Years	Loc	Ins
56594				
CHEV EQUINOX	ALL	10-17	S1,S2	20
GMC TERRAIN	ALL	10-17	S1,S2	20
56673				
FORD FREESTAR	ALL	04-07		5
MERC MONTEREY	MINIVAN	04-07		5



TESTED. PROVEN. SAFE.

CURT products are thoroughly tested and proven safe to give your customers confidence for the road ahead. That is why we continue to manufacture all of our custom hitches in the USA and why we maintain dedicated engineering teams in Eau Claire, WI, Brandon, SD and Perry, FL, as well as a testing and engineering facility in Detroit, MI.

Our goal isn't just to produce a stronger hitch or a more dependable wiring harness. We want to give our consumers the means to enjoy their lifestyle. We want to give hardworking contractors a solid foundation to grow their business, dedicated sportsmen a shot at that next big adventure and ordinary families an unforgettable vacation.

Whether they're towing 30,000 pounds of industrial equipment or packing up their cargo carrier for a weekend getaway, CURT offers your customers the freedom to pursue their passion and the peace of mind to enjoy every mile of it.

