

# INSTALLATION MANUAL

# 70127

## Level of Difficulty

Easy

Installation difficulty levels are based on time and effort involved and may vary depending on the installer level of expertise, condition of the vehicle and proper tools and equipment.

## Installed Attachment Tabs

Height	17"
Width	31"

## Parts List

Item	Qty	Description
1	1	Tow bar base plate, driver side
2	1	Tow bar base plate, passenger side
3	1	Mounting tab support bracket, passenger side - short
4	1	Mounting tab support bracket, driver side - tall
5	2	Tow bar mounting tab
6	2	Safety cable, 7,500 lbs.
7	2	Hex bolt, 1/2"-13 x 1-1/2", grade 8
8	4	Carriage bolt, 3/8"-16 x 1-1/4", grade 8
9	4	Hex bolt, M12-1.75 x 80mm, CL10.9
10	4	Serrated-flange nut, 3/8"-16, grade 8
11	2	Handle nut, 1/2"-13, grade 8
12	2	Flat washer, 1/2"
13	6	Conical-toothed washer, 1/2"
14	2	Quick link, 1/2"
15	2	Socket plug
16	4	Fishwire, 3/8"

## Tools Required

Socket, 15mm	Torque wrench
Socket, 18mm	Wrench, 7/16"
Socket, 7/16"	--

## WARNING

Never exceed the vehicle manufacturer's recommended towing capacity.

## Product Photo

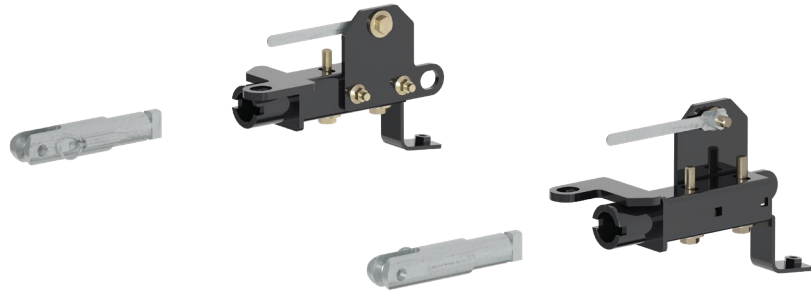

Not pictured: Safety cables, quick links and socket plugs

## NOTICE

Before you begin installation, read all instructions thoroughly.

Proper tools will improve the quality of installation and reduce the time required.

This installation requires:

- Removal of tow hooks
- Temporary removal of underbody shield
- Fishwiring to install hardware
- No drilling or trimming required

To help prevent damage to the product or vehicle, refer to the specified torque specifications when securing hardware during the installation process.

If equipped, we recommend removing the base plate attachment tabs when not in use.

## SAFETY INSTRUCTIONS

Safety glasses should be worn at all times while installing this product.

# ASSEMBLY

## Parts List

Item	Qty	Description
1	1	Tow bar base plate, driver side
2	1	Tow bar base plate, passenger side
3	1	Mounting tab support bracket, passenger side - short
4	1	Mounting tab support bracket, driver side - tall
5	2	Tow bar mounting tab
6	2	Safety cable, 7,500 lbs.
7	2	Hex bolt, 1/2"-13 x 1-1/2", grade 8
8	4	Carriage bolt, 3/8"-16 x 1-1/4", grade 8
9	4	Hex bolt, M12-1.75 x 80mm, CL10.9
10	4	Serrated-flange nut, 3/8"-16, grade 8
11	2	Handle nut, 1/2"-13, grade 8
12	2	Flat washer, 1/2"
13	6	Conical-toothed washer, 1/2"
14	2	Quick link, 1/2"
15	2	Socket plug
16	4	Fishwire, 3/8"

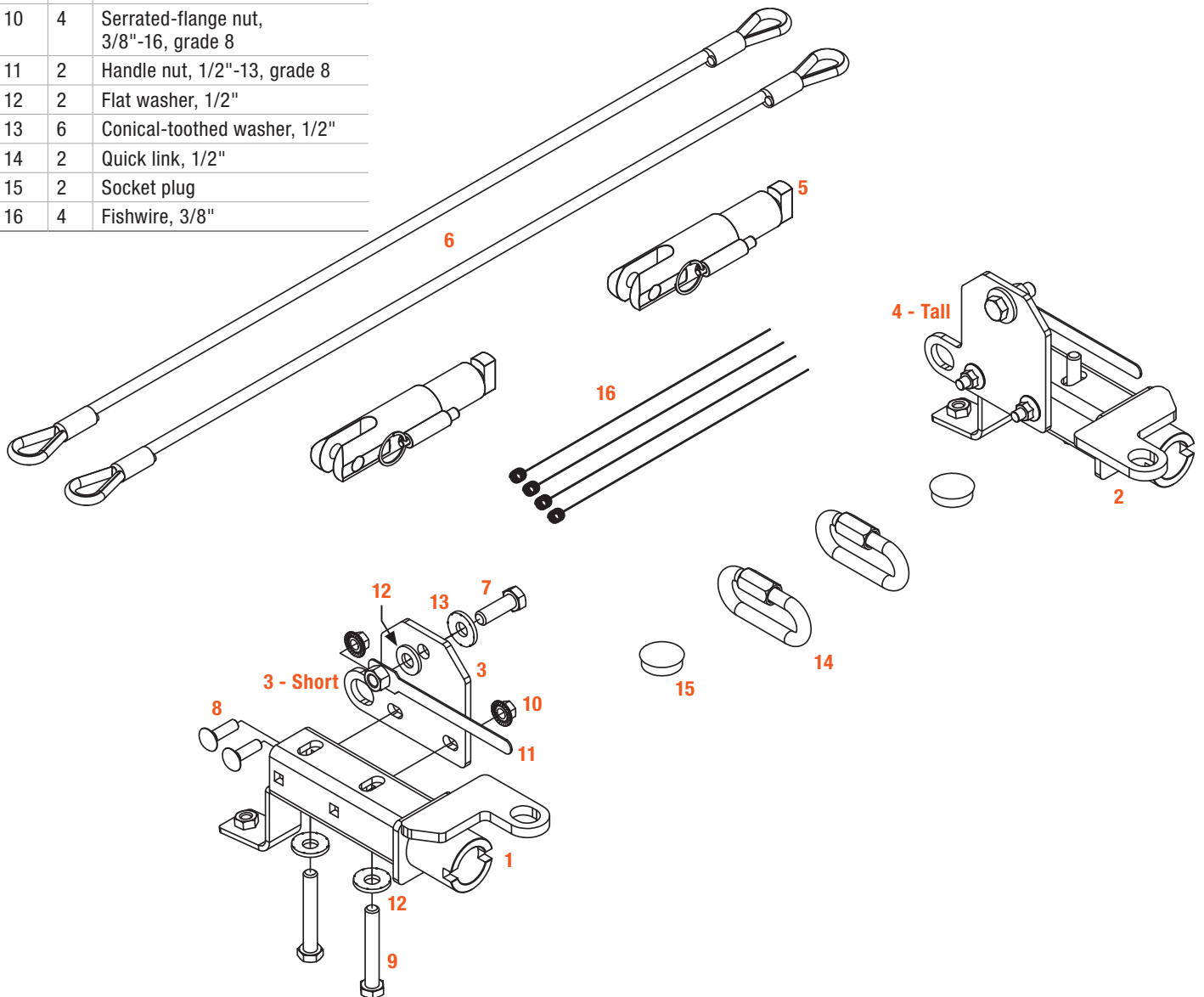

# SKID SHIELD & TOW HOOK REMOVAL

## Step 1

Use a 15mm socket to remove the four bolts from the skid shield under the front end – two at the front and two at the rear. Remove the skid shield and set it aside.

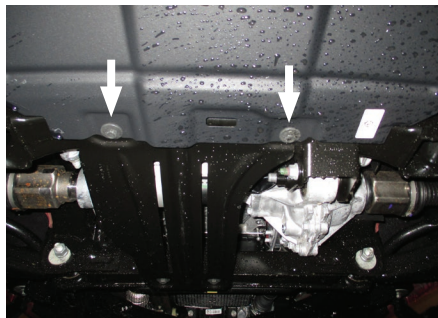

## Step 2

Remove the plastic shroud around the tow hook on each side of the vehicle. These shrouds will not be reinstalled.



### Step 3

Use a 15mm socket to remove the two bolts securing the tow hook in place. Set the tow hook aside.

Repeat on the other side of the vehicle.

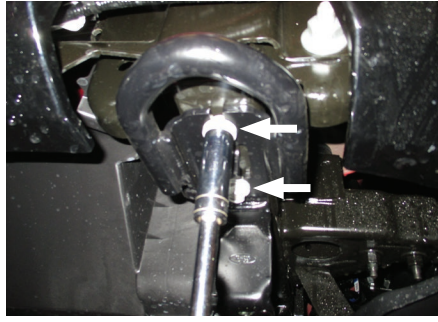

# TOW BAR BASE PLATE INSTALLATION

### Step 4

Identify the two included mounting tab support brackets (#3, #4). Starting with the taller bracket on the driver side (#4), insert a 1/2" hex bolt (#7) with a conical-tooth washer (#13) into the top hole and then place a flat washer (#12) onto the bolt on the other side of the plate.

Next, thread the bolt into the factory hole above the tow hook mounting holes and loosely install a 1/2" handle nut (#11).

Repeat on the passenger side of the vehicle with the shorter support bracket (#3).

Bend the end of the handle over so that it's flush to the end of the frame.

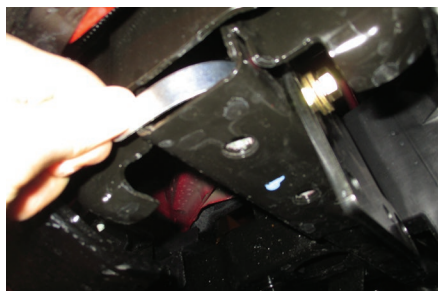
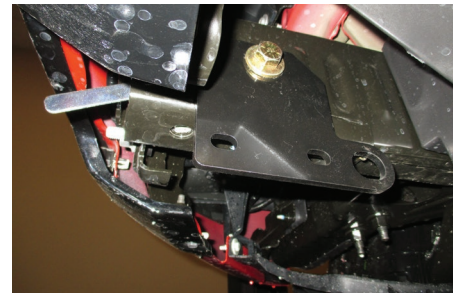
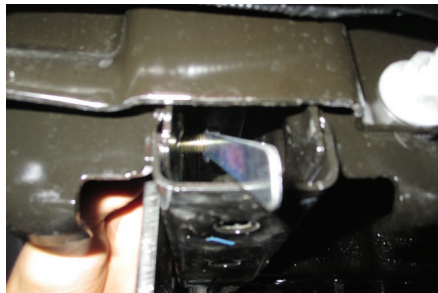
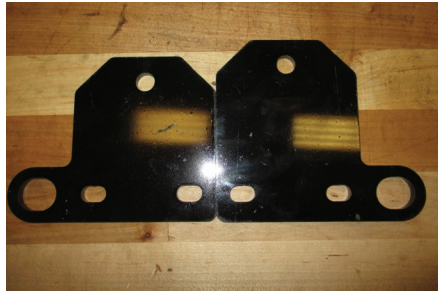

## Step 5

Position the driver-side tow bar base plate (#1) on the vehicle frame with the safety cable loops facing the center of the vehicle. Secure it to the support bracket (#4) by fishwiring (#16) two 3/8" carriage bolts (#8) into the square holes on the engine side. Secure with 3/8" serrated-flange nuts (#10)

Repeat on the other side of the vehicle using the passenger-side tow bar base plate (#2).

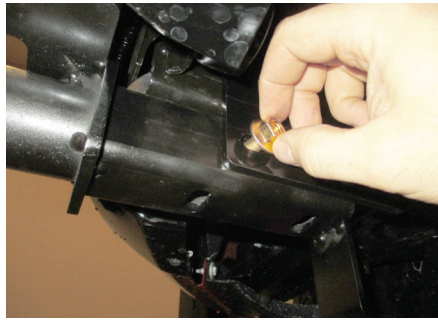
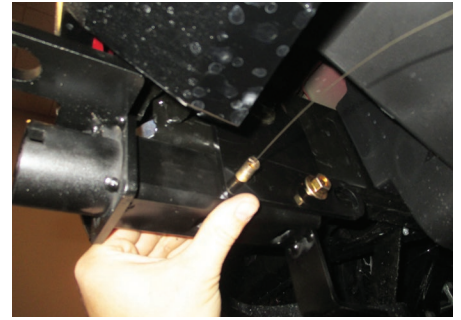
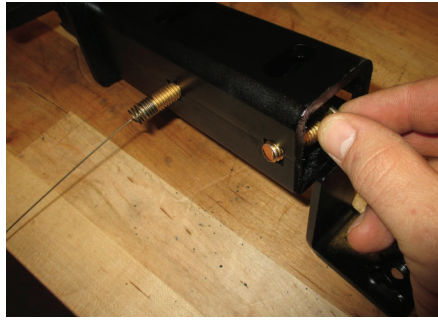
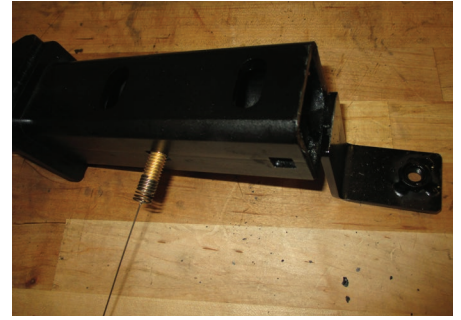
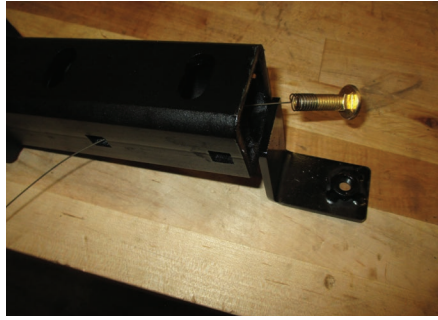

## Step 6

Install two M12 hex bolts (#9) and 1/2" conical-tooth washers (#13), one in each factory tow hook mounting hole.

Repeat on the other side of the vehicle.

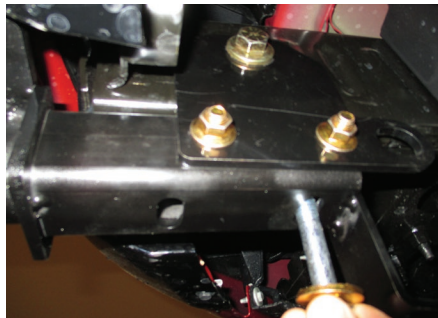

### Step 7

Torque all hardware in this order:  
3/8" hardware to 36 lb-ft, M12 hardware to 79 lb-ft and all 1/2" hardware to 110 lb-ft.

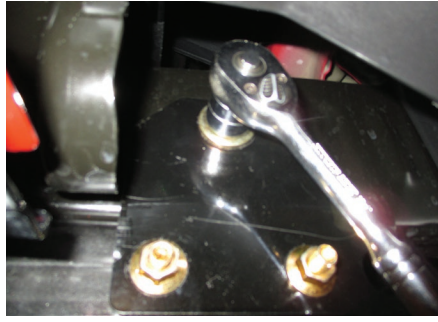

### Step 8

Install the permanent safety cables (#6) and quick links (#14), looping them around the vehicle frame and linking them to the tow bar base plates (#1,#2). There must be one cable on each side of the vehicle.

Make sure the cables do not pinch or interfere with any hoses, wiring or other components.

See 'Installing the Permanent Base Plate Safety Cables' for additional information.



### Step 9

Reinstall the skid shield, using the factory hardware.

When ready to tow, install the tow bar mounting tabs (#5). When not towing, insert the socket plugs (#15) into the ends of the tow bar base plates (#1,#2).

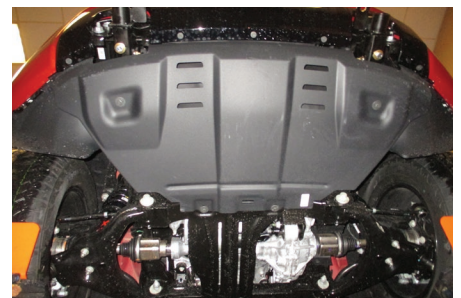

## Final Installed Image



# SAFETY CABLE INSTALLATION

## Installing the Permanent Base Plate Safety Cables

When dinghy towing a vehicle with a tow bar, base plate safety cables should be used at all times. In the event of a disconnect, the safety cables are designed to help prevent complete vehicle separation. When installing the safety cables, use the illustrations below as a guide.

### Installation guidelines

1. The cables must be connected to the base plate and the vehicle frame.
2. Two cables must be installed.
3. Each cable must meet or exceed the gross weight of the towed vehicle.
4. Make sure cables do not pinch or interfere with hoses, wiring or other components.

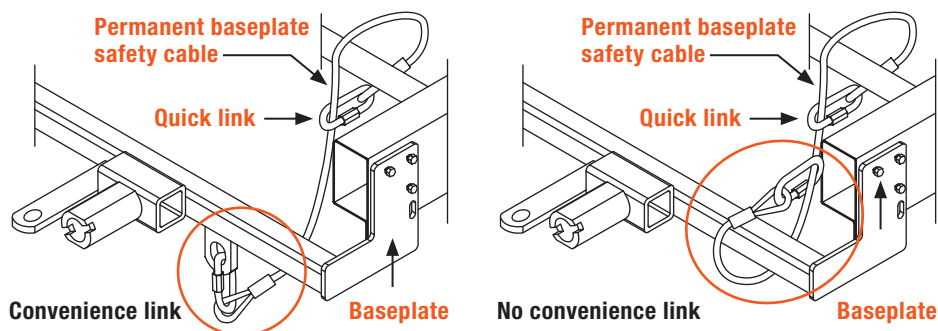

**Note:** Base plate safety cables are not a replacement for safety chains connecting the tow vehicle to the towed vehicle.

# ADDITIONAL INFORMATION

## Towing Tips

### Check your equipment

Periodically check the condition of all towing equipment. Ensure all fasteners are tight and that all structural components are sound. Do not tow with worn or damaged parts.

### Vehicle manufacturer's recommendations

Review the owner's manual for your towed vehicle and towing vehicle for specific recommendations, capacities and requirements.