

INSTALLATION MANUAL

70120

Level of Difficulty

Difficult

Installation difficulty levels are based on time and effort involved and may vary depending on the installer level of expertise, condition of the vehicle and proper tools and equipment.

Installed Attachment Tabs

Height	18"
Width	32-1/2"

Parts List

Item	Qty	Description
1	2	Tow bar base plate, universal
2	1	Safety cable loop bracket, driver-side
3	1	Safety cable loop bracket, passenger-side
4	2	Tow bar mounting tab
5	2	Safety cable, 7,500 lbs.
6	2	Slotted spacer plate
7	2	Round-hole spacer, 1/4" x 2" x 2"
8	2	Hex bolt, 1/2"-13 x 1-1/2", grade 8
9	4	Hex bolt, 1/2"-13 x 5", grade 8
10	6	Conical washer, 1/2"
11	4	Flange nut, 1/2"-13, grade 8
12	2	Quick link, 1/2"
13	2	Socket plug

Tools Required

Torque wrench	Drill
Socket, 7/16"	Drill bit, 1/2"
Socket, 3/4"	Hole saw, 1-1/4"
Socket, 7mm	Nut driver, 5/16"
Socket, 10mm	Flat head screwdriver
Socket, 15mm	Tape measure
Socket, 18mm	Wrench, 3/4"
Wrench, 7/16"	Wrench, 18mm
Large vise grip	Utility knife

⚠ WARNING

Never exceed the vehicle manufacturer's recommended gross vehicle weight rating (GVWR).

Product Photo

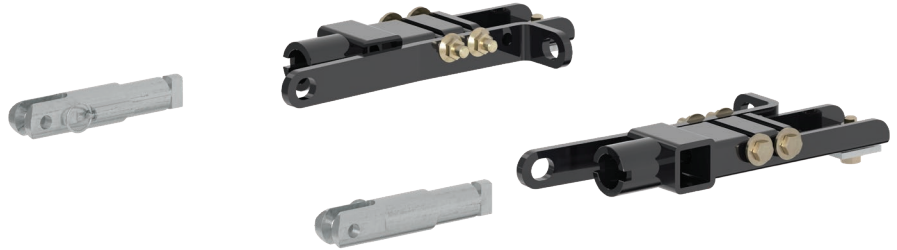

Not pictured: Safety cables, quick links and socket plugs

⚠ CAUTION

Take care when cutting any plastic or metal as injury may occur if done improperly.

NOTICE

instruction manual, as well as helpful videos, guides and much more!

Before you begin installation, read all instructions thoroughly.

Proper tools will improve the quality of installation and reduce the time required.

This installation requires fascia panels and the bumper to be temporarily removed and reinstalled. Some drilling and trimming are also required.

To help prevent damage to the product or vehicle, refer to the specified torque specifications when securing hardware during the installation process.

If equipped, we recommend removing the base plate attachment tabs when not in use.

SAFETY INSTRUCTIONS

Safety glasses should be worn at all times while installing this product.

ASSEMBLY

Parts List

Item	Qty	Description
1	2	Tow bar base plate, universal
2	1	Safety cable loop bracket, driver-side
3	1	Safety cable loop bracket, passenger-side
4	2	Tow bar mounting tab
5	2	Safety cable, 7,500 lbs.
6	2	Slotted spacer plate
7	2	Round-hole spacer, 1/4" x 2" x 2"
8	2	Hex bolt, 1/2"-13 x 1-1/2", grade 8
9	4	Hex bolt, 1/2"-13 x 5", grade 8
10	6	Conical washer, 1/2"
11	4	Flange nut, 1/2"-13, grade 8
12	2	Quick link, 1/2"
13	2	Socket plug

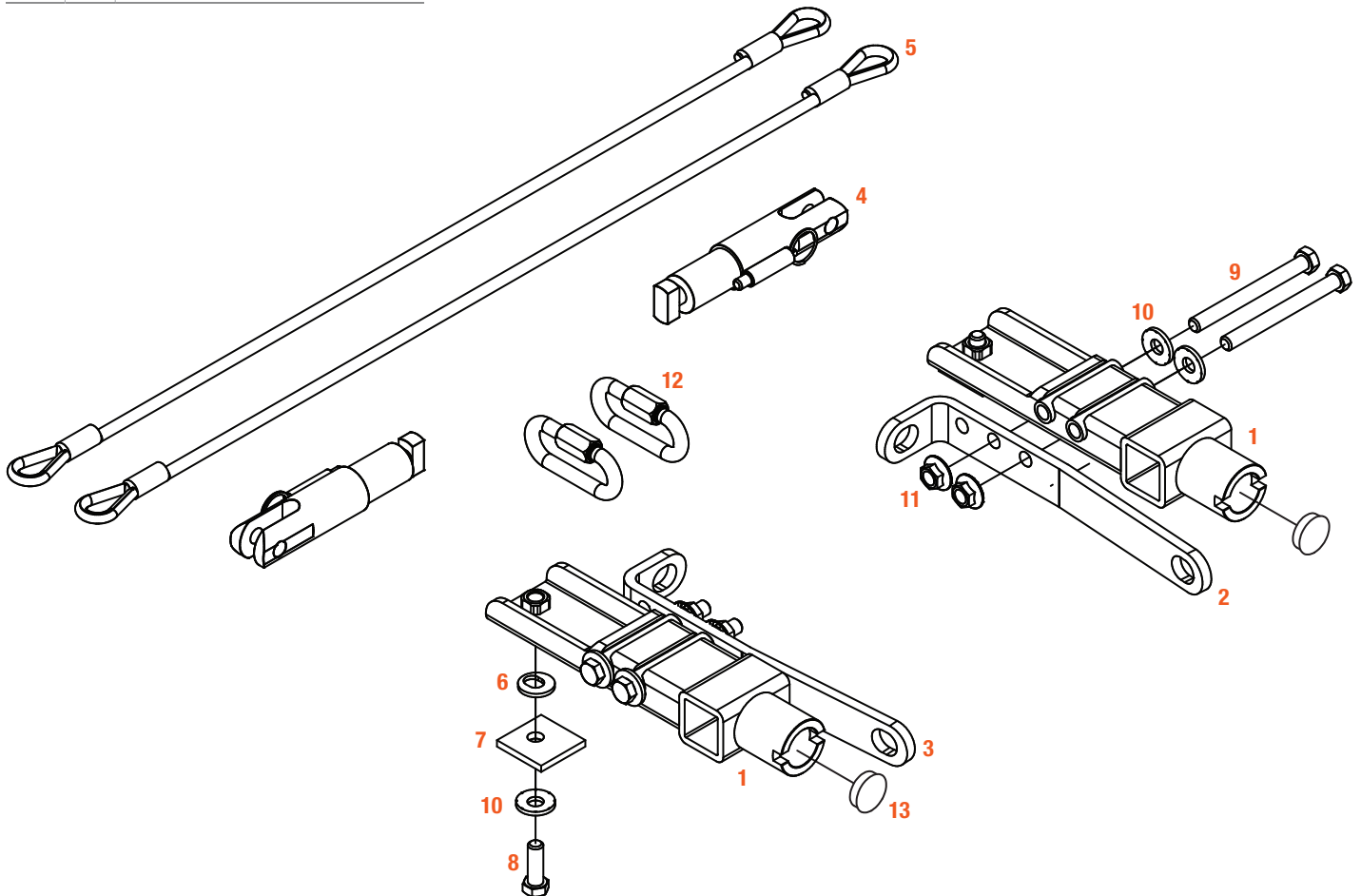

FASCIA REMOVAL

SUV MODELS

Step 1

Open the hood and remove the 12 push pins in the top fascia cover, six on each side. Remove the cover and set it aside.

Use a 10mm socket to remove the six screws along the top edge of the fascia / grille, three on each side. Also, disconnect the wiring harness on the passenger side.

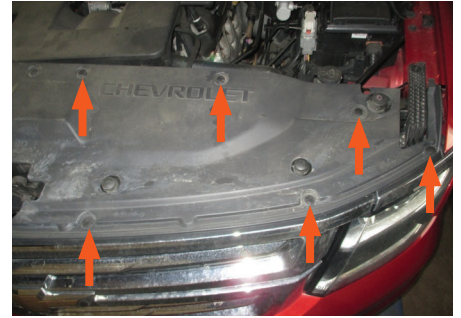
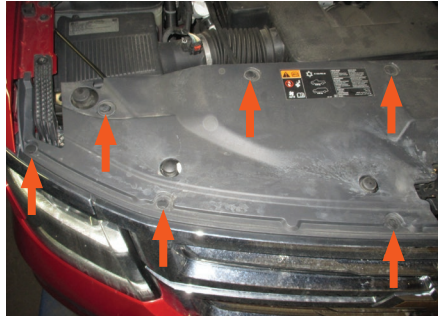

Step 2

Use a 7mm socket to remove the screws along the inside edge of the wheel well liner.

Repeat on the other side of the vehicle.



Step 3

Use a 10mm socket to remove the six screws on the bottom edge of the fascia, three on each side. Also, remove the push pins in front of the tires, one on each side.

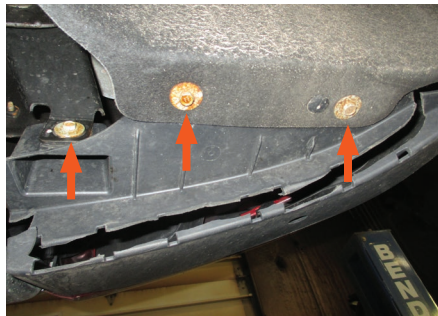

SUV MODELS (CONTINUED)

Step 4 - Z71 Models Only

For Z71 models only, use a 16mm socket to remove the four bolts holding the belly pan in place, two at the front and two at the rear.

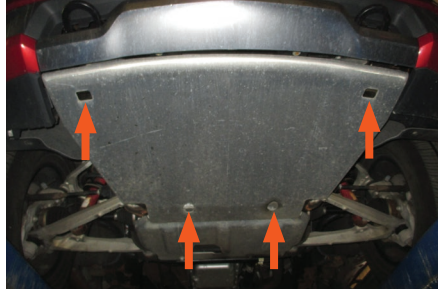

Step 5

Use a 10mm socket to remove the two screws on the underside of the front fascia.



Step 6

Unplug the electrical connections. Remove the fascia by carefully pulling the corners away from the vehicle. Be sure to release the two clips near the base of the grille.

Set the fascia aside.

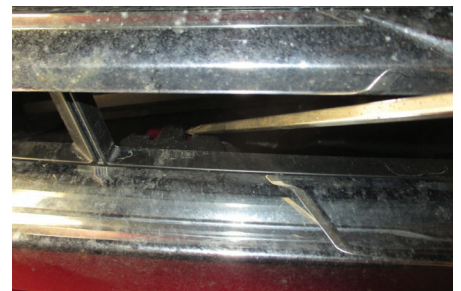

PICKUP MODELS

Step 7

From under the bumper, remove the 15 small bolts, six on each side and three in the center, that hold the plastic fascia to the steel bumper.

Use a flathead screwdriver to remove the three clips on each side from the plastic tabs over the tow loop openings. Remove the plastic fascia from the vehicle.

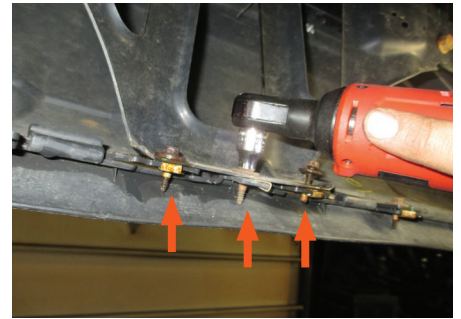
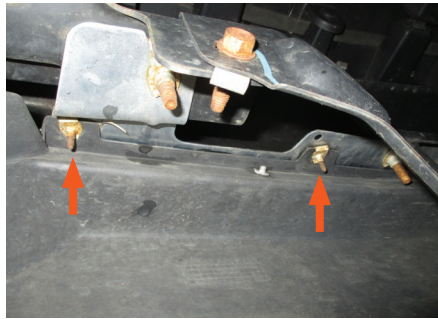
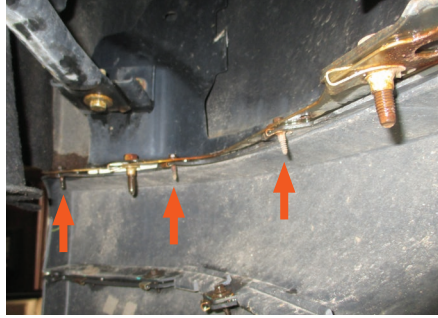

Step 8

Trim the six tabs that had the clips from the plastic fascia with a utility knife.

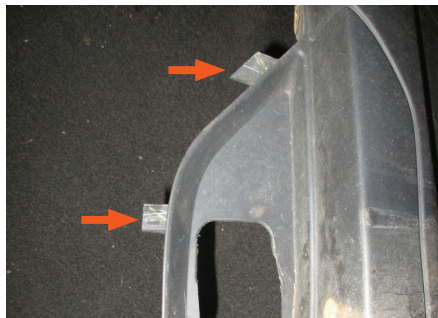

ALL MODELS

Step 9

Use an 18mm socket to remove the bolts holding the tow hook in place. Then, remove the tow hook and return them to the vehicle owner as they will not be reinstalled.

Repeat on the other side of the vehicle.

Tahoe and Suburban models will have three bolts in each tow hook.

Silverado and Sierra models will have two bolts in each tow hook.



TOW BAR BASE PLATE INSTALLATION

Step 10

Slide the tow bar base plate (#1) into the vehicle frame opening and insert the front 1/2" x 5" hex bolt (#9). Then, start threading the bottom 1/2" x 1-1/2" hex bolt (#8) with a 1/2" conical washer (#10), round-hole spacer (#7) and slotted spacer plate (#6) as shown.

Snug the hardware but do not fully tighten. Repeat on the other side of the vehicle.

Note: If the base plate does not fit into the frame, carefully tap the sides of the frame opening outward with a hammer or touch the tube spacers in the base plate with a grinder for snug fit. Also, the bottom hole may need to be enlarged to align with the slotted opening.



Step 11

Using the rear, side base plate hole as a guide, drill a 1/2" hole in the vehicle frame.

Note: For the driver side, drill the hole from the inside. For the passenger side, drill from the outside.



Step 12

Starting on the driver's side, remove the previously installed front hex bolt (#9) from the tow bar base plate (#1) and position the safety cable loop bracket (#2) on the inside of the frame. Then, insert both 1/2" x 5" hex bolts (#9) with 1/2" conical washers (#10), from the outside of the frame directed inward, and secure them with the supplied 1/2" flange nuts (#11).

Torque all of the hardware to 110 lb-ft. Repeat on the other side of the vehicle using the passenger-side safety cable loop bracket (#3).

Note: The front two holes in the safety cable loop bracket are preferred for mounting. However, if additional clearance is needed, the two rear holes may be used.

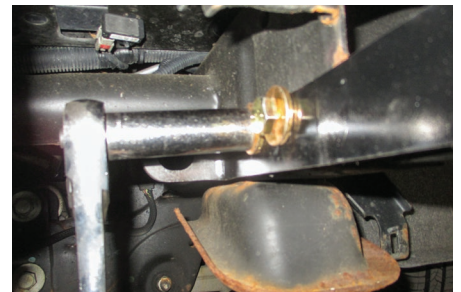

Step 13

Install the permanent safety cables (#5) and quick links (#12), looping them around the vehicle frame and linking them to the safety cable loop brackets (#2,#3). There must be one cable on each side of the vehicle.

Make sure the cables do not pinch or interfere with any hoses, wiring or other components.

See 'Installing the Permanent Base Plate Safety Cables' for additional information.



Step 14

Use a utility knife to trim out the tow hook openings on each side of the front fascia.



Step 15

Reinstall components previously removed.

For Z71 models: Reinstall the belly pan, the grille, front fascia and top fascia cover.

For Pickups: Reinstall the lower plastic fascia with the 12 screws previously removed.

When ready to tow, install the tow bar mounting tabs (#4). When not towing, insert the socket plugs (#13) into the ends of the tow bar base plates (#1).

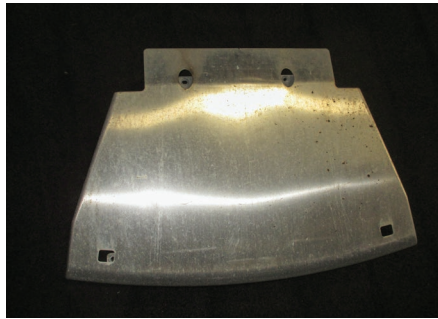

Final Installed Image



SAFETY CABLE INSTALLATION

Installing the Permanent Base Plate Safety Cables

When dinghy towing a vehicle with a tow bar, base plate safety cables should be used at all times. In the event of a disconnect, the safety cables are designed to help prevent complete vehicle separation. When installing the safety cables, use the illustrations below as a guide.

Installation guidelines

1. The cables must be connected to the base plate and the vehicle frame.
2. Two cables must be installed.
3. Each cable must meet or exceed the gross weight of the towed vehicle.
4. Make sure cables do not pinch or interfere with hoses, wiring or other components.

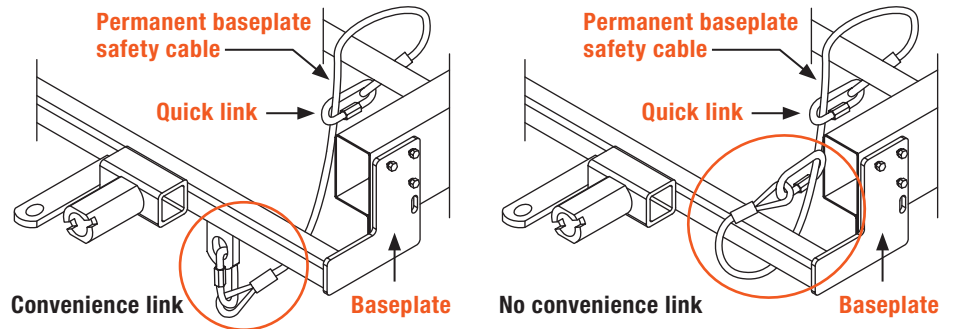

Note: Base plate safety cables are not a replacement for safety chains connecting the tow vehicle to the towed vehicle.

ADDITIONAL INFORMATION

Towing Tips

Check your equipment

Periodically check the condition of all towing equipment. Ensure all fasteners are tight and that all structural components are sound. Do not tow with worn or damaged parts.

Vehicle manufacturer's recommendations

Review the owner's manual for your towed vehicle and towing vehicle for specific recommendations, capacities and requirements.