

INSTALLATION MANUAL

70105

Level of Difficulty

Moderate

Installed Attachment Tabs

Height	18"
Width	24"

Parts List

Item	Qty	Description
1	1	Tow bar base plate
2	2	Spacer plate, 1" x 5/8"
3	2	Tow bar mounting tab
4	2	Safety cable, 7,500 lbs.
5	2	Hex head cap screw, M10 x 1-1/2", 35mm, CL10.9
6	2	Conical washer, 3/8"
7	2	Carriage bolt, 1/2"-13 x 2-1/4", grade 8
8	2	Carriage bolt, 1/2"-13 x 1-1/2", grade 8
9	4	Square hole spacer, 1/4" x 1" x 3"
10	4	Flange nut, 1/2"-13, grade 8
11	2	Quick link, 1/2"
12	2	Socket plug

Tools Required

Torque wrench	Drill
Socket, 3/4"	Drill bit, 1/2"
Socket, 7/16"	Wrench, 7/16"
Socket, 13mm	Reciprocating saw
Socket, 16mm	Nut driver, 5/16"
Socket, 17mm	Fishwire, 1/2"
Socket, 18mm	(includes two)

⚠ WARNING

Never exceed the vehicle manufacturer's recommended gross vehicle weight rating (GVWR).

Product Photo



Not pictured: Safety cables, quick links and socket plugs

⚠ CAUTION

Take care when cutting any plastic or metal as injury may occur if done improperly.

NOTICE

Before you begin installation, read all instructions thoroughly.

Proper tools will improve the quality of installation and reduce the time required.

This installation requires the factory bumper and front underbody panel to be temporarily removed and reinstalled. Some drilling and trimming are required.

To help prevent damage to the product or vehicle, refer to the specified torque specifications when securing hardware during the installation process.

If equipped, we recommend removing the base plate attachment tabs when not in use.

Torque Specifications

Metric	Bolt Size	CL8.8	CL10.9	SAE	Bolt Size	Grade 5	Grade 8
	M6 bolt	6.6 ft-lbs.	9.4 ft-lbs.		1/4" bolt	86 in-lbs.	122 in-lbs.
M8 bolt	16.0 ft-lbs.	22.9 ft-lbs.	5/16" bolt	178 in-lbs.	251 in-lbs.		
M10 bolt	31.6 ft-lbs.	45.2 ft-lbs.	3/8" bolt	26 ft-lbs.	37 ft-lbs.		
M12 bolt	55.1 ft-lbs.	78.9 ft-lbs.	7/16" bolt	42 ft-lbs.	59 ft-lbs.		
M14 bolt	88.1 ft-lbs.	126.1 ft-lbs.	1/2" bolt	75 ft-lbs.	110 ft-lbs.		
M16 bolt	136.7 ft-lbs.	195.6 ft-lbs.	5/8" bolt	128 ft-lbs.	180 ft-lbs.		
M18 bolt	195.4 ft-lbs.	270.3 ft-lbs.	3/4" bolt	227 ft-lbs.	320 ft-lbs.		

Use above torque setting unless otherwise noted

ASSEMBLY

Parts List

Item	Qty	Description
1	1	Tow bar base plate
2	2	Spacer plate, 1" x 5/8"
3	2	Tow bar mounting tab
4	2	Safety cable, 7,500 lbs.
5	2	Hex head cap screw, M10 x 1-1/2", 35mm, CL10.9
6	2	Conical washer, 3/8"
7	2	Carriage bolt, 1/2"-13 x 2-1/4", grade 8
8	2	Carriage bolt, 1/2"-13 x 1-1/2", grade 8
9	4	Square hole spacer, 1/4" x 1" x 3"
10	4	Flange nut, 1/2"-13, grade 8
11	2	Quick link, 1/2"
12	2	Socket plug

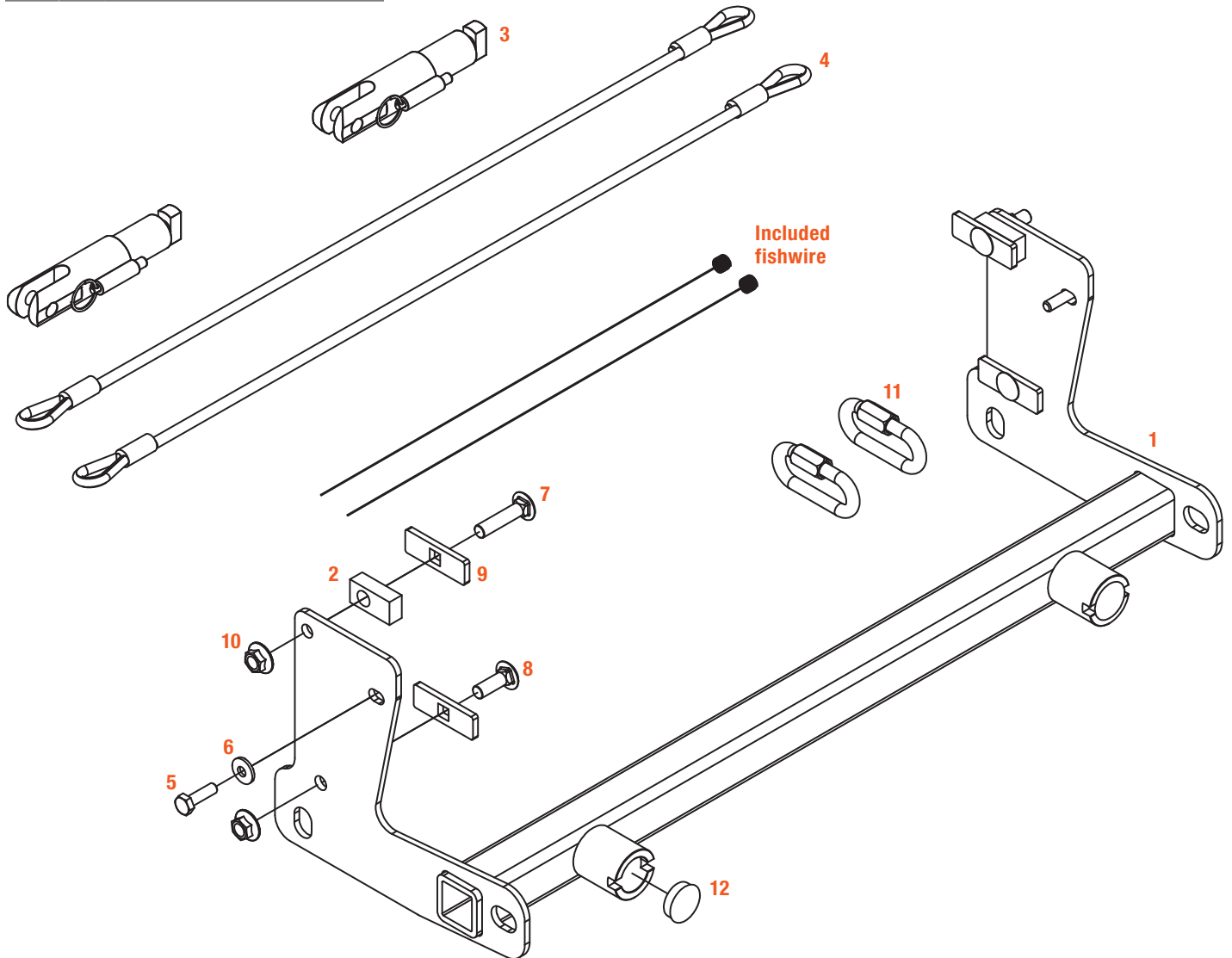

BUMPER REMOVAL

TRAILHAWK MODELS ONLY

Step 1

Use a 13mm socket to remove the seven bolts holding the front underbody panel in place. Once removed, set the panel aside.

Unplug the fog light wiring harness on the passenger side as shown. Unhook any attachment points that the bumper wiring has into the vehicle frame.

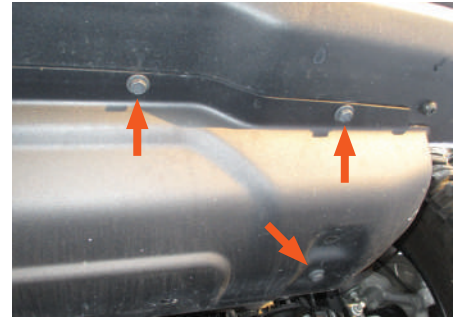
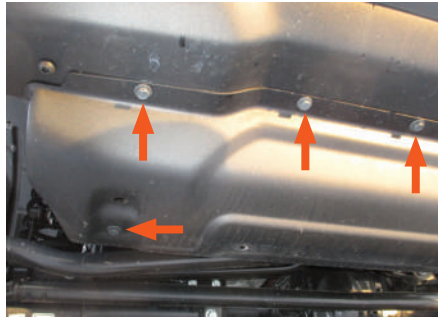

Step 2

Use an 18mm socket to remove the eight nuts securing the bumper to the vehicle frame – four on each side.

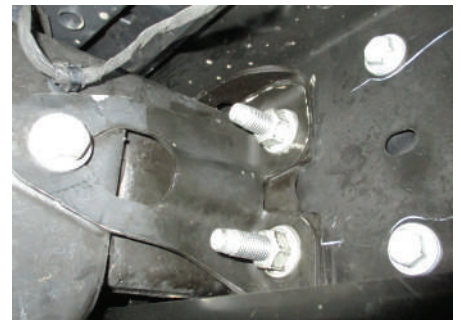

Step 3

Use a 16mm socket to remove the bolt on the outside edge of the bumper bracket.

Repeat on the other side of the vehicle.

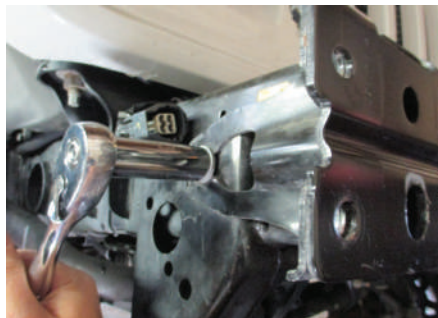

TRAILHAWK MODELS ONLY (CONTINUED)

Step 4

Unhook the trim on the top of the bumper by pulling out the two push pins on either side. Remove the bumper assembly and set aside.

Skip to step 12.



ALL MODELS EXCLUDING TRAILHAWK

Step 5

Use an 8mm socket to remove the two bolts holding the front underbody panel in place.



Step 6

Remove the eight push pins around the front edge of the underbody panel.

Once removed, set the panel aside.

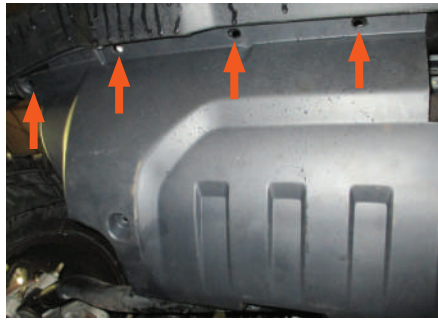

Step 7

Use a 16mm socket to remove the two bolts holding the metal guard plate in place. Once removed, set the plate aside.



ALL MODELS EXCLUDING TRAILHAWK (CONTINUED)

Step 8

Remove the push pin behind each bumper tow hook – one on each side – holding the bumper trim in place. Once removed, set the trim aside.



Step 9

Unplug the fog light wiring harness on the passenger side as shown. Unhook any attachment points that the bumper wiring has into the vehicle frame.



Step 10

Use an 18mm socket to remove the eight nuts securing the bumper to the vehicle frame – four on each side.

Once removed, set the bumper aside.



Step 11

Use a 16mm socket to remove the bolt on the outside edge of the bumper bracket.

Repeat on the other side of the vehicle.



TOW BAR BASE PLATE INSTALLATION

Step 12

Enlarge the center hole in the frame as shown to make room for the 1/2"-13 x 1-1/2" carriage bolt (#8) head and 1/4" square hole spacer (#9) to pass through.

Repeat on the other side of the vehicle.

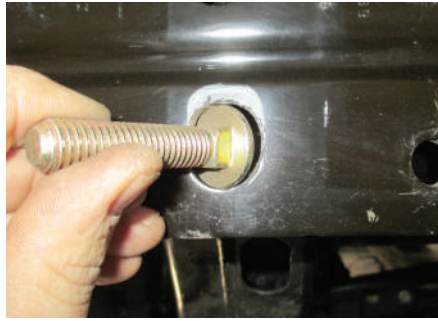

Step 13

Position the tow bar base plate (#1) on the vehicle frame and install a supplied M10 hex head cap screw (#5) with 3/8" conical washer (#6) in the top, forward-most hole in the side plate.

Level the tow bar base plate and snug the hardware, but do not fully tighten.

Repeat on the other side of the vehicle.



Step 14

Making sure the tow bar base plate is level, use the top, rearward hole in the side plate as a guide, drill a 1/2" hole in the vehicle frame.

Repeat on the other side of the vehicle.

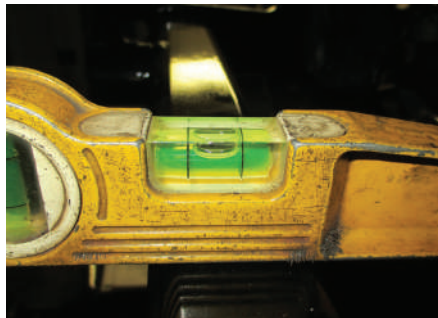

Step 15

Loosen the top, forward most bolt and install a spacer plate (#2) between the base plate (#1) and vehicle frame.

Fishwire a 1/2"x 2-1/4" (#7) carriage bolt and 1/4" square hole spacer (#9) into the top, rearward hole, through the end of the frame and secure it with a 1/2" flange nut (#10).

Then, rotate the spacer plate (#2), making it flush with the base plate (#1).

Torque the 1/2" fasteners to 110 lb-ft.

Repeat on the other side of the vehicle.

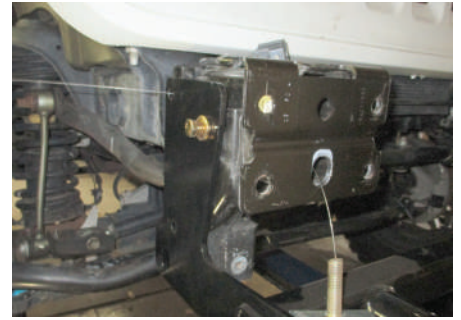
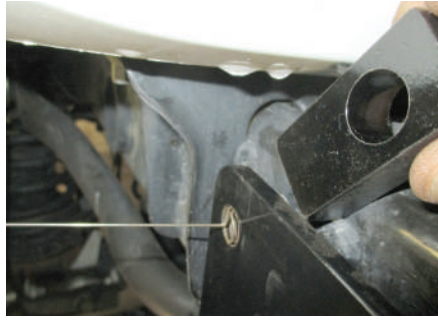

Step 16

Remove the top, forward-most bolt (#5, #6) and reinstall the factory bumper bracket between the base plate (#1) and vehicle frame. Make sure the bumper bracket is flush with the front of the vehicle frame and reinstall the hex head cap screw (#5), conical washer (#6) and nut.

Torque M10 fasteners to 45 lb-ft.

Repeat on the other side of the vehicle.

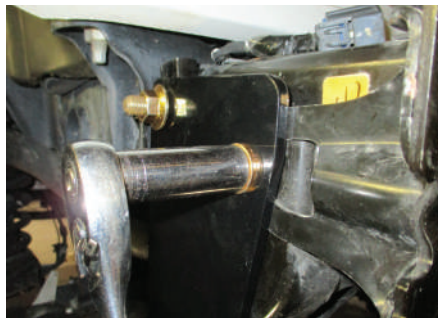
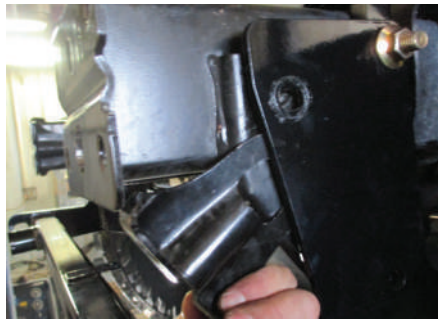

Step 17

Fishwire a 1/2" x 1-1/2" carriage bolt (#8) and 1/4" square hole spacer (#9) in the bottom hole through the end of the frame into the base plate (#1) and secure it with a flange nut (#10). Enlarging the hexagonal hole with a 1/2" drill bit may be necessary.

Torque 1/2" fasteners to 110 lb-ft.

Repeat on the other side of the vehicle.



Step 18

Install the permanent safety cables (#4) and quick links (#11), looping them around the vehicle frame and linking them to the tow bar base plate (#1). There must be one cable on each side of the vehicle.

Make sure the cables do not pinch or interfere with any hoses, wiring or other components.

See 'Installing the Permanent Base Plate Safety Cables' for additional information.

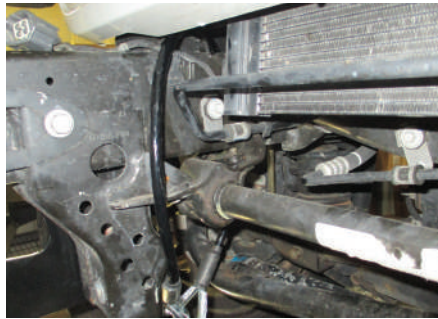

Step 19

Reinstall the factory bumper, and plug in the passenger-side wiring harness and clips.



Step 20

Hold up the underbody panel in its original position and mark where it will need to be trimmed to make space for the safety cable loops and attachment tabs. Each area will be about 1" wide x 6-5/8" long on each side of the vehicle.

Trim off the marked area.



Step 21

Reinstall the underbody panel and any trim removed during the install.

When ready to tow, install the tow bar mounting tabs (#3). When not towing, insert the socket plugs (#12) into the ends of the tow bar base plates (#1).



Final Installed Image



SAFETY CABLE INSTALLATION

Installing the Permanent Base Plate Safety Cables

When dinghy towing a vehicle with a tow bar, base plate safety cables should be used at all times. In the event of a disconnect, the safety cables are designed to help prevent complete vehicle separation. When installing the safety cables, use the illustrations below as a guide.

Installation guidelines

1. The cables must be connected to the base plate and the vehicle frame.
2. Two cables must be installed.
3. Each cable must meet or exceed the gross weight of the towed vehicle.
4. Make sure cables do not pinch or interfere with hoses, wiring or other components.

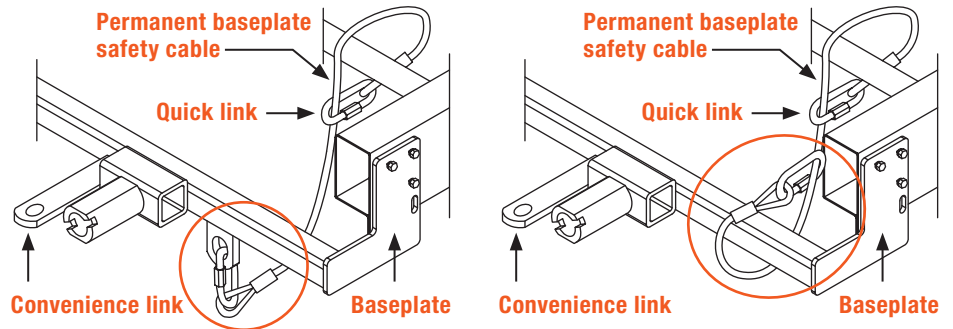

Note: Base plate safety cables are not a replacement for safety chains connecting the tow vehicle to the towed vehicle.

ADDITIONAL INFORMATION

Towing Tips

Check your equipment

Periodically check the condition of all towing equipment. Ensure all fasteners are tight and that all structural components are sound. Do not tow with worn or damaged parts.

Towing vehicle and trailer manufacturer's recommendations

Review the owner's manual for your towing vehicle and trailer for specific recommendations, capacities and requirements.