

INSTALLATION MANUAL

70104

Level of Difficulty

Hard

Installed Attachment Tabs

Height	15-1/2"
Width	24"

Parts List

Item	Qty	Description
1	1	Tow bar base plate
2	2	Tow bar mounting tab
3	2	Safety cable, 3,500 lbs.
4	4	Conical washer, 1/2"
5	6	Conical washer, 3/8"
6	6	Hex head cap screw, M8 x 1-1/4", 30mm, CL8.8
7	4	Hex head cap screw, 1/2"-13, 1-1/2", grade 5
8	1	Cable tie, 15"
9	4	Nut plate, 1/2"-13
10	2	Quick link, 1/4"
11	2	Socket plug

Tools Required

Torque wrench	Large vice grip
Socket, 3/4"	Flat screwdriver
Socket, 10mm	Utility knife
Socket, 12mm	Phillips screwdriver
Socket, 13mm	Punch and hammer
Tape measure	--

⚠ WARNING

Never exceed the vehicle manufacturer's recommended gross vehicle weight rating (GVWR).

Product Photo



Not pictured: Safety cables, quick links and socket plugs

⚠ CAUTION

Take care when cutting any plastic or metal as injury may occur if done improperly.

NOTICE

Before you begin installation, read all instructions thoroughly.

Proper tools will improve the quality of installation and reduce the time required.

This installation requires fascia panels, a temperature sensor and a coolant line to be temporarily removed / relocated and reinstalled. The bumper beam must also be removed and will not be reinstalled. Some trimming is required.

To help prevent damage to the product or vehicle, refer to the specified torque specifications when securing hardware during the installation process.

If equipped, we recommend removing the base plate attachment tabs when not in use.

Torque Specifications

Metric	Bolt Size	CL8.8	CL10.9	SAE	Bolt Size	Grade 5	Grade 8
	M6 bolt	6.6 ft-lbs.	9.4 ft-lbs.		1/4" bolt	86 in-lbs.	122 in-lbs.
M8 bolt	16.0 ft-lbs.	22.9 ft-lbs.	5/16" bolt	178 in-lbs.	251 in-lbs.		
M10 bolt	31.6 ft-lbs.	45.2 ft-lbs.	3/8" bolt	26 ft-lbs.	37 ft-lbs.		
M12 bolt	55.1 ft-lbs.	78.9 ft-lbs.	7/16" bolt	42 ft-lbs.	59 ft-lbs.		
M14 bolt	88.1 ft-lbs.	126.1 ft-lbs.	1/2" bolt	75 ft-lbs.	110 ft-lbs.		
M16 bolt	136.7 ft-lbs.	195.6 ft-lbs.	5/8" bolt	128 ft-lbs.	180 ft-lbs.		
M18 bolt	195.4 ft-lbs.	270.3 ft-lbs.	3/4" bolt	227 ft-lbs.	320 ft-lbs.		

Use above torque setting unless otherwise noted

ASSEMBLY

Parts List

Item	Qty	Description
1	1	Tow bar base plate
2	2	Tow bar mounting tab
3	2	Safety cable, 3,500 lbs.
4	4	Conical washer, 1/2"
5	6	Conical washer, 3/8"
6	6	Hex head cap screw, M8 x 1-1/4", 30mm, CL8.8
7	4	Hex head cap screw, 1/2"-13, 1-1/2", grade 5
8	1	Cable tie, 15"
9	4	Nut plate, 1/2"-13
10	2	Quick link, 1/4"
11	2	Socket plug

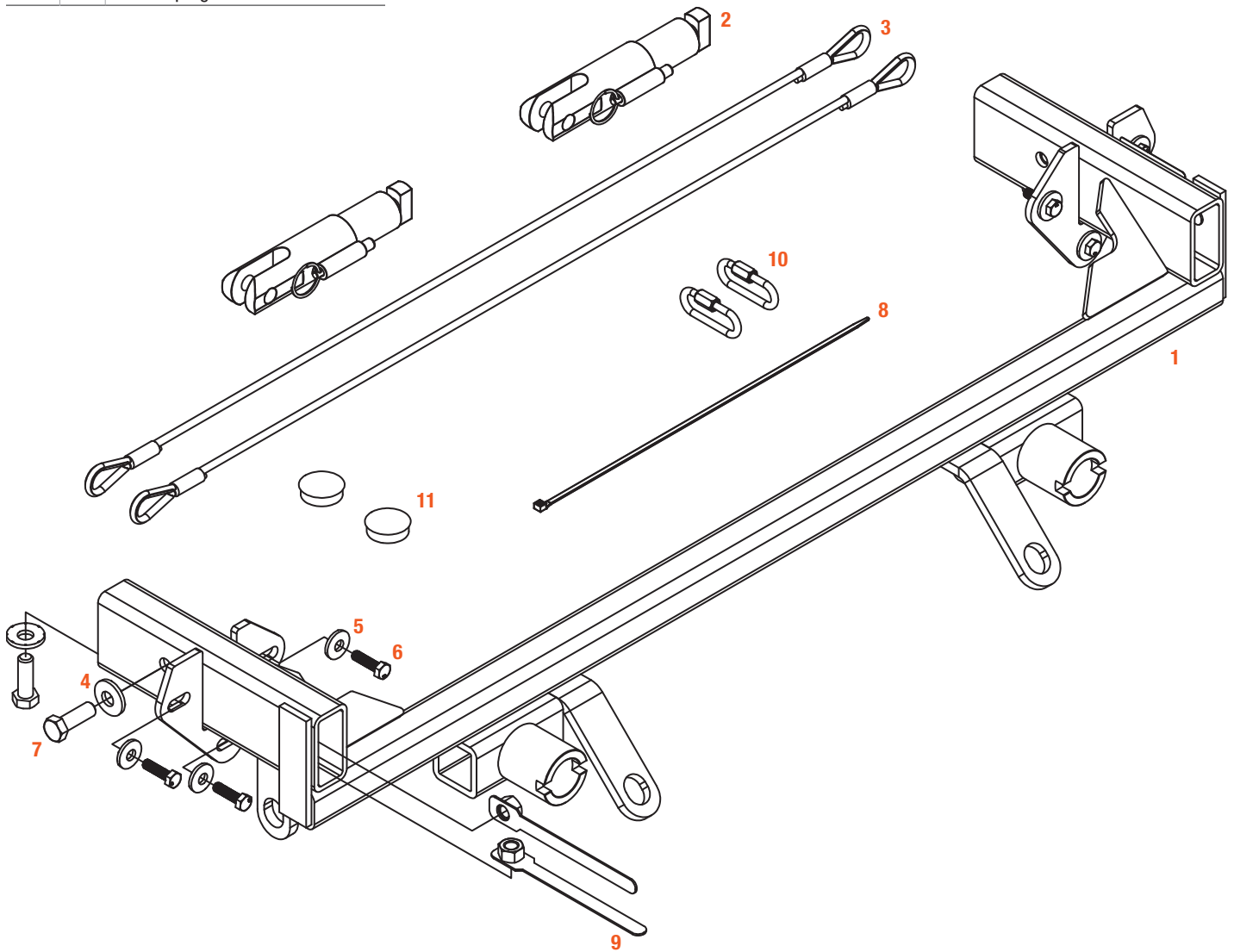

BUMPER REMOVAL

Step 1

Open the hood and pull out the four push pins holding the upper front fascia panel in place.



Step 2

Using a Phillips head Screwdriver, gently release the four yellow clips under the grille through the slots. Keeping slight pressure on the bottom of the grille, insert the screwdriver through the grille to release the two outermost yellow tabs for the top of the grille.

Carefully remove the grille and set it aside so it will not be damaged during the rest of the install.



Step 3

Use a Phillips head screwdriver to remove the screw at the bottom of the wheel well liner. Also remove the two push pins above the screw.

Unclip the front edge of the wheel well trim and pull back the liner. Then, remove the push pin in the seam of the bumper cover near the bottom edge of the wheel well.

Repeat on the other side of the vehicle.



Step 4

To remove the bumper cover, remove the screw with a 10mm socket and push pin with a flat head screw driver on the bottom side at the outer edge corner, in front of the wheel.

Repeat on the other side of the vehicle.



Step 5

Remove the four center push pins on the underside of the fascia.



Step 6

Carefully pull back the wheel well trim piece. Then, using a Phillips head screwdriver, remove the topmost screw holding the front bumper panel in place.

Repeat on the other side of the vehicle.



Step 7

Carefully release the two yellow corner clips in the grille area to completely remove the bumper cover.



Step 8

Carefully remove the bumper cover by pulling the corners out and away from the vehicle. Make sure to unplug the fog light wiring harnesses on each side.

Once the bumper cover is removed, set it aside so it will not be damaged during the rest of the installation.

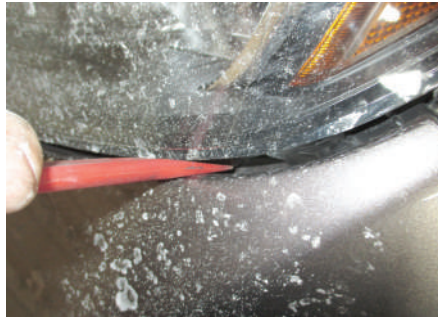
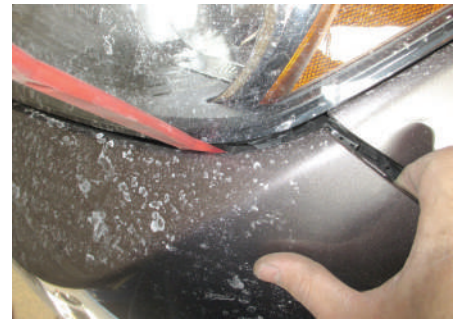
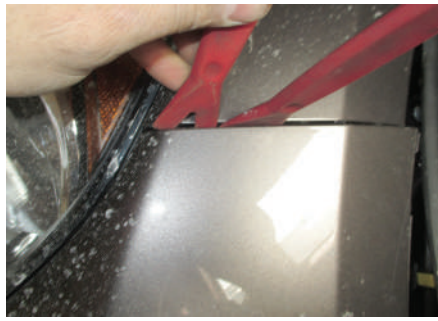

Step 9

Use a 12mm socket to remove the four bolts from the bumper beam. There is one bolt on the top and three facing the front of the vehicle on the bracket.

Repeat on the other side of the vehicle.

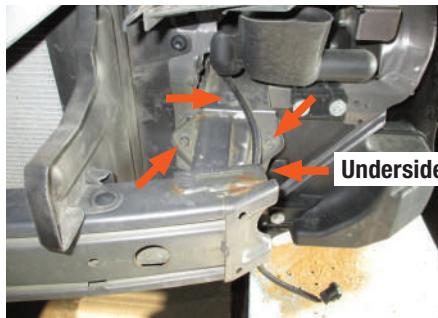

Step 10

Remove the push pin on the bottom passenger-side of the bumper beam.

Then, release the push pin on the driver-side temperature sensor and two wire harness clips (one on the bottom and one on the side) to remove it. The sensor will need to be relocated for proper base plate installation.



Step 11

Use a flathead screwdriver to remove the push pins on the top, outer corners of the bumper.

Repeat on the other side of the vehicle.

Carefully remove the bumper beam and return it and the hardware to the vehicle owner.



TOW BAR BASE PLATE INSTALLATION

Step 12

Using a paint pen, mark the areas around the radiator on the rubber shroud that need to be trimmed.

Starting on the passenger side, use a utility knife to cut the bracket straight down as shown. The driver-side of the rubber radiator shroud will need to be trimmed with a notch, measuring 2-1/2" from the bottom as shown.

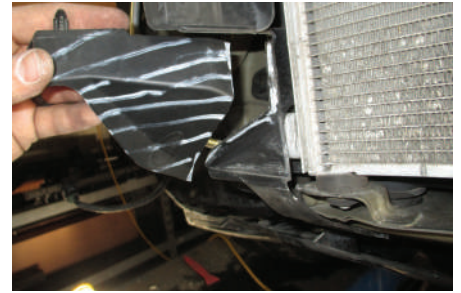

Step 13

Use a utility knife to trim the rubber mounting flanges on either side of the radiator. Measure 1-1/4" from the bottom and follow the notched lines as shown.



Step 14

Remove the weld nut on the inside of the vehicle frame tube using a punch and hammer.

Straighten the frame if needed and repeat on the other side of the vehicle.

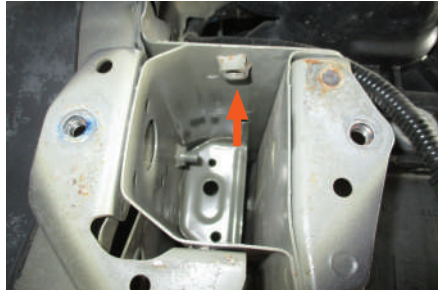

Step 15

Unclip the coolant line above the frame on the passenger side. Carefully move it out of the way to make room for the tow bar base plate.

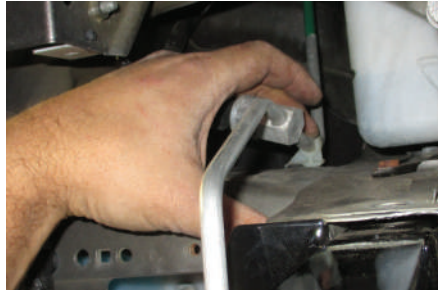

Step 16

Install the tow bar base plate (#1), inserting the brackets into the vehicle frame tubes on either side.

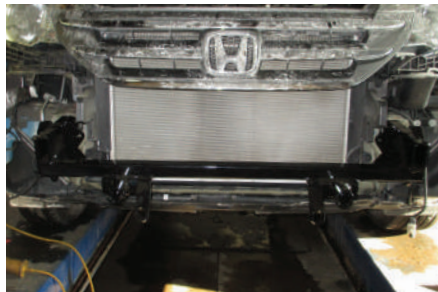

Step 17

Make sure the base plate mounting holes are aligned with the factory bumper holes. Secure the base plate with three M8 hex head cap screws (#6) and 3/8" conical washers (#5) on either side of the vehicle.

Snug the hardware, but do not fully tighten.



Step 18

Insert a 1/2" nut plate (#9) on the inside edge of the frame and install a 1/2" hex head cap screw (#7) with 1/2" conical washer (#4) into the side hole in the vehicle frame.

Repeat on the other side of the vehicle.

Make sure the base plate is level and torque the hardware to 110 lb-ft.

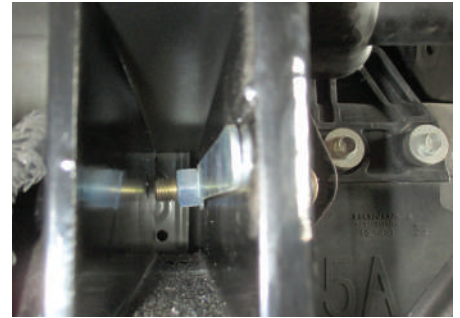
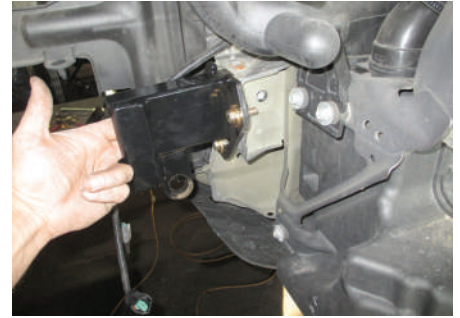

Step 19

Insert a 1/2" nut plate (#9) on the inside edge of the frame and install a 1/2" hex head cap screw (#7) with 1/2" conical washer (#4) into the bottom hole in the vehicle frame.

Repeat on the other side of the vehicle and torque the hardware to 110 lb-ft.

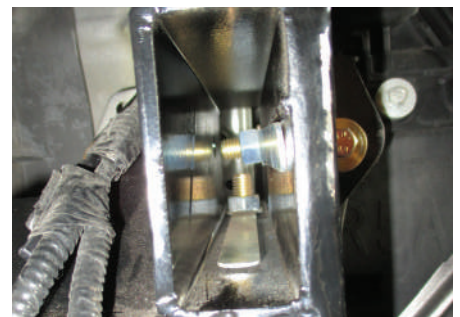
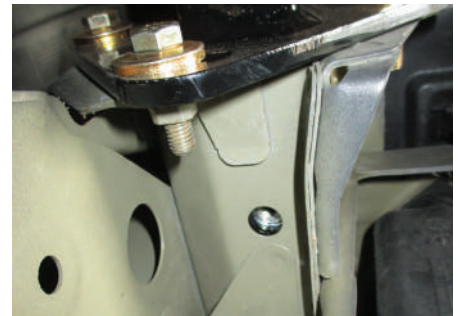

Step 20

Torque the six M8 bolts from Step 17 to 16 lb-ft.



Step 21

Make sure the coolant line will not interfere with the attachment tab by slightly bending it away as needed. Then, clip it back into place on the fender.

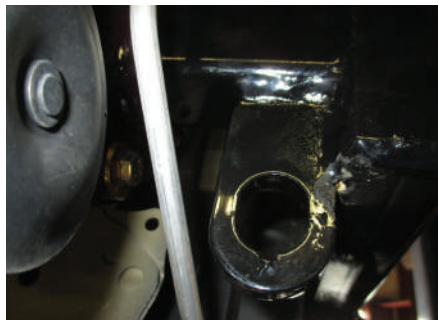

Step 22

Reattach the temperature sensor to the base plate (#1) using the included cable tie (#8).



Step 23

Install the permanent safety cables (#3) and quick links (#10), looping them around the vehicle frame and linking them to the tow bar base plate (#1). There must be one cable on each side of the vehicle.

Make sure the cables do not pinch or interfere with any hoses, wiring or other components.

See 'Installing the Permanent Base Plate Safety Cables' for additional information.



Step 24

Hold up the bumper cover in its original position and mark where it may need to be trimmed to make space for the safety cable loops and attachment tabs. We recommend trimming a smaller area first and then doing a test fit and trimming again as needed.



Step 25

Reinstall the bumper cover, front grille and other components that were removed during the install.

When ready to tow, install the tow bar mounting tabs (#2). When not towing, insert the socket plugs (#11) into the ends of the tow bar base plate (#1).

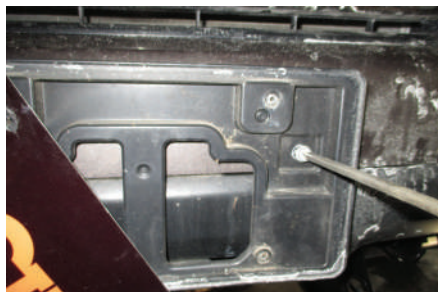

Final Installed Image



SAFETY CABLE INSTALLATION

Installing the Permanent Base Plate Safety Cables

When dinghy towing a vehicle with a tow bar, base plate safety cables should be used at all times. In the event of a disconnect, the safety cables are designed to help prevent complete vehicle separation. When installing the safety cables, use the illustrations below as a guide.

Installation guidelines

1. The cables must be connected to the base plate and the vehicle frame.
2. Two cables must be installed.
3. Each cable must meet or exceed the gross weight of the towed vehicle.
4. Make sure cables do not pinch or interfere with hoses, wiring or other components.

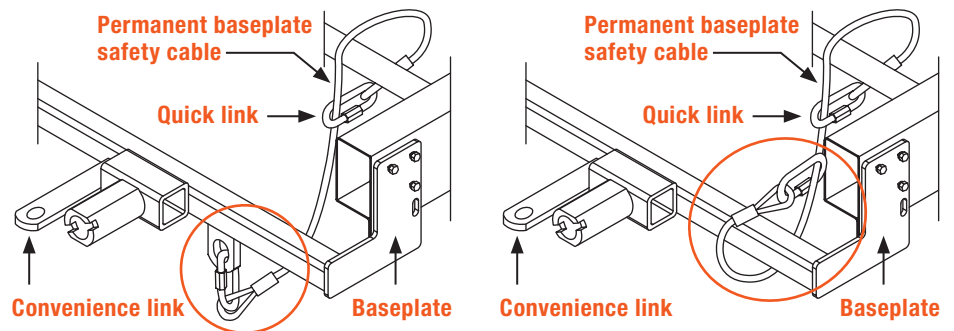

Note: Base plate safety cables are not a replacement for safety chains connecting the tow vehicle to the towed vehicle.

ADDITIONAL INFORMATION

Towing Tips

Check your equipment

Periodically check the condition of all towing equipment. Ensure all fasteners are tight and that all structural components are sound. Do not tow with worn or damaged parts.

Towing vehicle and trailer manufacturer's recommendations

Review the owner's manual for your towing vehicle and trailer for specific recommendations, capacities and requirements.