



51160

INSTALLATION MANUAL

ASSURE™ BRAKE CONTROLLER

For use with 12-volt negative ground systems only

For trailers with two to eight brakes

Read, follow and save this guide for future reference



This package includes:

- | | |
|---|-----------------------------|
| (1) Brake controller module with quick plug | (4) Mounting bracket screws |
| (1) Mounting bracket | (1) Quick reference card |
| (2) Keyed spacer | (2) Keyed washer |

One or more of the following may be needed to complete installation:

- Brake controller connection harness, supplied with the tow vehicle (if equipped)
- CURT quick plug adapter harness - custom connector for specific vehicles.
See website for availability
- CURT part# 51515 / 51516 - male quick plug with pigtails
- CURT part# 51500 - brake controller wiring kit

Important Information

Read and follow installation and setup instructions carefully. Failure to do so could result in damage to the brake controller, no trailer brakes or poor brake performance.

Disconnect the electrical plug between the trailer and tow vehicle before testing a breakaway switch. Failure to disconnect may damage the brake controller.

Avoid mounting the brake controller module near a CB radio or other RF transmitter.

⚠ WARNING The brake controller must be mounted firmly in place.

Failure to do so could lead to improper operation and / or brake failure.

⚠ WARNING The brake controller's positive (with 30-amp circuit breaker) and ground wires must be connected directly to the tow vehicle's battery using 10-gauge minimum stranded wire. Connecting to existing wiring or an alternate ground may damage vehicle circuits, lead to failure of the brake controller module, loss of trailer brakes or vehicle fire.

NOTICE Removal of the factory-supplied quick plug can void warranty.

Key Features

- OLED display provides detailed brake force output and sensitivity position
- Provides automatic and manual trailer braking
- Switchable manual control output, 100% or limited to output setting
- Switchable manual control brake light activation or no brake light activation
- Compatible with electronic systems (anti-lock brakes and cruise control)
- Protected against reverse voltage, voltage spikes, shorts and overloads
- Controller will take 10 seconds to power up as it scans for a trailer connection. It will then stay in standby mode until either the vehicle is restarted, the buttons are pressed, or a trailer with electric brakes is connected.
- Display is capable of communicating operational errors
- Reduced output when sitting still (railroad crossing, stoplight, etc...)
- Automatically compensates for uphill and downhill road conditions
- Will work with most electrically activated hydraulic trailer brake systems

Controls and Components

1. OLED display
2. Load (sensitivity) adjustment
3. Gain (output) adjustment
4. Pressure-sensitive manual control button
5. Quick plug connector
6. Switch for manual control brake activation - allows for 100% output
7. Switch for manual control brake light activation
8. Mounting bracket
9. Washer, spacer, and screw for mounting controller to bracket
10. Self-tapping screw for mounting bracket to vehicle

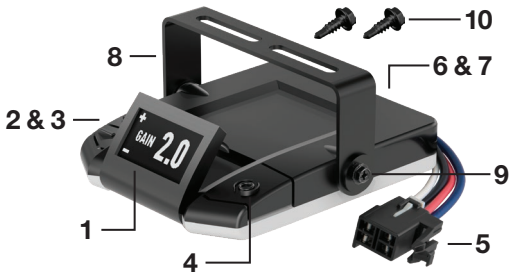

Gain Control (output)

The gain (output) control buttons establish the maximum amount of power available to the trailer brakes when braking.

An exception is when the manual control is set up for 100% braking, see 'Set Manual Control Gain / Output and Brake Light Switches'.

As the gain (output) control buttons are adjusted, the screen will show the new gain (output) setting. The tactile button with the (+) increases the power available to the brakes and the button with the (-) will decrease the power available to the brakes. The gain (output) control may be adjusted during initial setup, when trailer load changes, when different trailers are used or when adjustment is needed for changing road or driving conditions.

The maximum gain (output) setting is shown as '**Gain**' on the display when a trailer is connected and the brake pedal is pressed or the manual control is actuated. If a trailer is not connected, the output screen will display nothing.

Load Control (sensitivity)

The load control (sensitivity) adjusts trailer brake aggressiveness. To view the load (sensitivity) setting on the display, press the (+) and (-) buttons at the same time. This will trigger the '**Load**' display. The load (sensitivity) control adjustment does not have any effect on the manual control. The load (sensitivity) control adjustments cater to the preferences of the individual driver, trailer load changes or changing road conditions. The load (sensitivity) control can be adjusted from 1 to 9, using the (+) and (-) buttons to increase or decrease the aggressiveness of the trailer brakes.

Manual Control















The manual control is located on the front of the brake controller at the right side and only applies the trailer brakes. Manual brake control activation is used during initial setup and in situations where a slow reduction in speed is desirable. The manual control button on the right side is pressure sensitive. The harder the manual brake button is pressed, the more intensely the brakes are being applied. The intensity will be displayed on screen.

The manual control can be set up to either allow 100% of the unit's power to the trailer brakes or to limit power to the output control setting. This feature is set up at installation via a small switch at the rear of the unit. See 'Set Manual Control Gain / Output and Brake Light Switches' on page 8 of this instruction manual. The brake controller is shipped from the factory with the switch in the 'limited to the output control' setting position.

The output will be shown on the display when the manual control is actuated. Brake light activation with the manual control is also an optional setting. Some tow vehicles' circuits do not allow power for brake lights from a second source. In these applications, the brake light feature can be switched off using a second small switch at the rear of the unit. The brake light connection (red wire) is still required to activate the Assure™ brake controller with the switch in either position. See 'Set Manual Control Gain / Output and Brake Light Switches'. The brake controller is shipped from the factory with the switch in the 'activate brake light' position.

OLED Display

The OLED display shows the output setting when the control is activated. It is used to set up and monitor the brake controller and can be used when troubleshooting.

 Startup / Calibration screen	 Calibrating
 Not Connected - Standby mode, no trailer connected	 Overload - Output circuit, trailer brake system fault
 Connected - Standby mode, trailer connected	 Low Volt - Tow vehicle system
 Brakes activated, flashing	 Error - Accelerometer error, powers brakes using default values
 Gain - Output adjustment	 Short - Stoplight wire (red) shorted to ground
 Load - Sensitivity adjustment	 Blank display, standby mode, illuminates when control is activated
 Disconnect - Flashing, trailer disconnected, off after 60 seconds	 Blank display, does not illuminate when control is activated, check installation
 Reconnect - Recalibration needed, unplug and replug trailer connector	

INSTALLATION

Set Manual Control Gain / Output and Brake Light Switches

There are two small switches located at the rear of the controller that can be accessed by removing the rectangular cover. Once accessed, the switch positions can be changed using a small pointed tool.

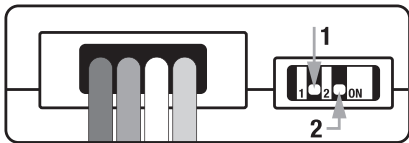

In the illustration above, the switch on the left (#1) controls the unit's brake light activation feature. The factory default setting is the 'ON' position with the switch down. This setting activates the tow vehicle and trailer brake lights when the manual control is actuated. Moving the switch up to the 'OFF' position turns off the brake light activation feature and the brake lights are not activated when the manual control is actuated.

The switch on the right (#2) controls the manual trailer brake activation feature. The factory default setting is the 'ON' position with the switch down. This setting limits the manual control output to the level set using the output adjustment buttons. Moving this switch up to the 'OFF' position allows 100% of the output to the brakes when the manual control is actuated regardless of the output control setting.

Mounting

1. Determine a suitable mounting location.
 - A) The unit must be mounted securely to a solid surface
 - B) The unit must be easily reached by the driver
 - C) The area behind mounting location must be clear so no damage will be done when drilling

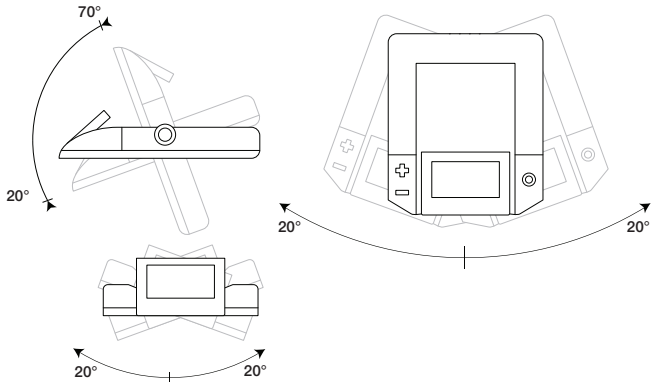

2. Hold the mounting bracket in the selected position and mark the hole locations through the bracket.
3. Using a 1/8" diameter bit, drill holes in the marked locations.
4. With a screwdriver or a 1/4" nut driver, secure the bracket in place using two of the provided self-tapping screws. Do not over-tighten.
5. Install the spacer from the inside of the bracket with the key end going through the opening in the bracket. Place the washer on the keyed spacer and repeat on the other side. Insert the controller into the bracket and install the screws.

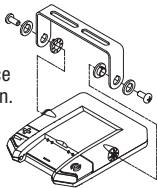

Wiring

Disconnect the tow vehicle's negative battery terminal from its battery post before beginning the wiring process. Most pick-ups and utility vehicles are equipped with a plug from the factory that allows quick brake controller installation. Check the owner's manual for plug availability, location and installation.

Use a CURT part# 51515 / 51516 universal trailer brake controller harness to splice into the plug supplied with the vehicle or use a CURT custom wiring harness. See the CURT catalog or visit curtmfg.com for application information.

For tow vehicles not equipped with a factory brake controller plug, we suggest CURT brake control wiring kit, part# 51500.

Mount a 30-amp, auto reset, circuit breaker as close to the battery as possible.

IMPORTANT: When passing wire through sheet metal, always go through an existing grommet, add a grommet or use silicone sealer to protect the wire from sharp edges.

WIRING DIAGRAM

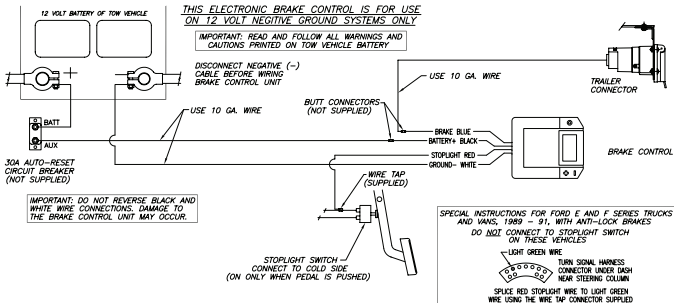

Feed two 10-gauge wires, one white and one black, from the mounted brake controller to the battery area. Using a ring terminal, connect the black wire to the 'AUX' side of the 30-amp circuit breaker. Leave the white wire to be connected later.

Using a 10 / 12-gauge butt connector, attach the black wire from the 'AUX' side of the 30-amp circuit breaker to the brake controller's black wire. Again using a 10 / 12-gauge butt connector, attach the white wire from the battery area to the brake controller's white wire. Run a 10-gauge blue wire from the tow vehicle's trailer plug 'brake' terminal to the brake controller. Using a 10 / 12-gauge butt connector, splice this wire to the brake controller's blue wire

NOTE: Brake light switch connection on Ford vehicles including the Mercury Mountaineer, do not connect to the red wire with a green stripe. Connect to the light-green wire only.

For vehicles other than 1989-1991 Ford E- and F-Series trucks and vans with anti-lock brakes, use a test probe to determine which wire on the tow vehicle's stoplight switch is only 'hot' when the pedal is pressed. Splice the brake controller's red wire to this wire using a wire tap.

For 1989-1991 Ford E- and F-Series trucks and vans with anti-lock brakes, find the crescent-shaped connector located on the steering column. The connector has two rows of wires. The wire needed is the light-green wire, second from the end in the outside row of seven wires (see the box shown in wiring diagram). Splice the brake controller's red wire to light-green wire using a wire tap.

Using 10-gauge stranded wire and ring terminals, connect the 'BATT' side of the circuit breaker to the positive battery terminal.

Attach the white 10-gauge wire previously positioned near the battery to the negative battery terminal using a ring terminal. Reconnect the tow vehicle's negative battery terminal to its battery post. See vehicle owner's manual for special battery re-connection instructions.

Test the installation without a trailer connected by pushing the brake pedal. Either the **'Not Connected'** icon will show up on the display, the screen will return to off, or the screen will go into standby mode. If the not **'Not Connected'** icon does not display, or if **'Overload'**, **'Error'** or **'Short'** is shown, refer to the troubleshooting guide on page 18 of this instructional manual. After testing, secure all loose wires with cable ties to avoid damage to the wiring.

SETUP

Once all electrical connections are complete and the controller display is functioning, while parked on a level surface, plug the trailer's electrical connector into the tow vehicle's plug.

Connecting the trailer initiates the mounting position calibration mode.

The CURT logo with a progress bar may be seen on the display followed by either **'Connected'** or **'Not Connected'**. If **'Not Connected'** appears, recalibration is needed. To recalibrate, unplug and replug the trailer's electrical connector. While calibrating, the display will show **'Calibration'** or may flash the **'Output'** setting. When the **'Connected'** icon appears, the unit is calibrated and ready for setup.

Make the following preliminary adjustments with the trailer connected and engine running to ensure proper charge voltage. The vehicle must be in park or neutral with the parking brake applied, foot off the brake pedal and no manual control actuation.

Adjust output to 2.0 using the (+) button to increase, and the (-) button to decrease gain as needed. Press the (+) / (-) buttons at the same time to adjust the load control. Set the load to 1.0 for initial setup

Test Drive and Adjustment

Both gain (output) and load (sensitivity) can be adjusted to achieve smooth, firm stops. Output and load adjustments should only be made while stopped with the transmission in park or neutral, parking brake applied, foot off the brake pedal and no manual control actuation. Output and load settings will display in real time on the screen.

Begin with the output adjustment. Drive forward on a paved or concrete surface that is dry and level. At approximately 25 mph, apply the tow vehicle brakes. If trailer braking is insufficient, adjust the output with the (+) button. If the trailer brakes lockup adjust the output with the (-) button. Repeat this step until stops are firm, just short of lockup.

Once the output is set, adjust the load (to activate the load adjustment screen, press the (+) / (-) buttons at the same time). Drive forward to approximately 25 mph and press the brake pedal. Tow vehicle and trailer should make smooth stops. If the stops seem slow and more aggressive braking is desired, adjust the load setting to a larger number. If the stops seem too aggressive adjust the load setting to a smaller number.

Make several stops at various speeds and adjust load settings until stops are smooth and firm. Slight adjustment to the output control may also be desirable.

Note: If any problems occur during setup, refer the troubleshooting section.

HELPFUL TIPS

The manual control button (right side of the controller) is a tactile button. The more pressure applied to the button, the more aggressive the trailer brakes are applied with no effect on the vehicle's brakes. This is useful for gradual slowing on steep grades or before stops.

Periodic adjustment of the output and sensitivity controls may be necessary to correct for changing road conditions, trailer loading, brake wear or driver preference.

In some applications, when towing with hazard flashers on, the display will show the '**Gain**' icon flashing along with the hazard flashers. If the brake controller is set aggressively, pulsing may be felt in the trailer brakes.

BENCH TEST INSTRUCTIONS

Parts Needed:

Standard 1156 automotive bulb in a socket, charged 12V battery, alligator clip test leads or wire and wire nuts, 51515 / 51516 quick plug with pigtails or push pins

Note: If a quick plug pigtail is not available, push pins can be used to make a direct connection to the female terminals of the Assure™ quick plug housing.

 **CAUTION** Ensure that the brake controller wires, quick plug wires, push pins and test leads do not make contact with each other or any other metal surface – failure to do so may damage the brake controller.

Brake Controller Bench Test Setup

Connect the quick plug to the Assure™ to provide accessible wires for bench testing.

Connect the white ground wire of the Assure™ and the ground wire of the bulb to the negative terminal of the 12V battery.

Leave the red brake input wire and blue output wire unconnected.

Connect the black battery wire of the Assure™ to the positive terminal of the 12V battery.

If the brake controller is wired properly and the Assure™ is operational, the display will flash the current **'Load'** output followed by **'Not Connected'**.

Ensure the Assure™ is level to the bench surface and connect the signal wire of the bulb to the blue brake output wire of the Assure™.

The Assure™ will display that it's checking calibration, that it's calibrating, or that it needs re-calibration by displaying **'Reconnect'**. If the **'Reconnect'** indication appears, disconnect and reconnect the bulb from the blue wire to recalibrate. It will show **'Disconnect'** when disconnected followed by **'Calibration'**, followed by the **'Connected'** icon when complete.

Manual Control Testing

Using the (+) button, adjust the output to the maximum setting. Slowly activate the manual control button to its full output. Press both (+) / (-) buttons to access the load setting screen, using the (+) button to adjust to the maximum setting.

Accelerometer Testing

While keeping the brake controller level, connect the red brake input wire of the Assure™ to the positive terminal of the 12V battery. The brake controller output will activate and the bulb may be dimly lit.

Slowly tilt the front of the Assure™ to about 45° and the brightness of the bulb will increase corresponding with the output shown by the brake controller. Slowly tilt the front of the Assure™ back to level and the brightness of the bulb will decrease corresponding with the output shown by the brake controller.

When finished testing, disconnect the wiring from the positive terminal of the 12V battery ensuring the exposed contacts do not make contact. If the Assure™ does not function as described during the above test steps return the brake controller for service or replacement.





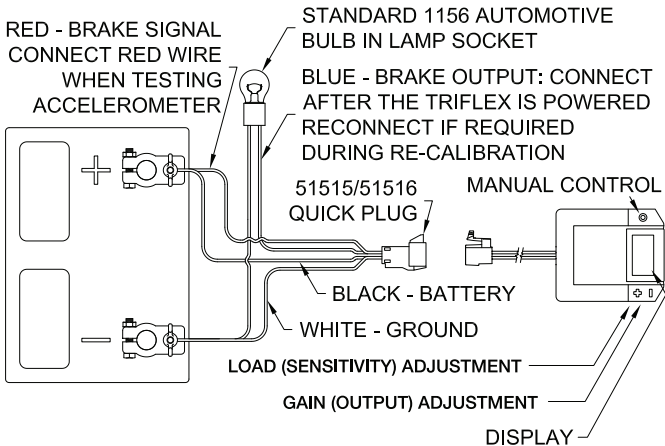

BENCH TEST DIAGRAM

⚠ WARNING Read and follow all warnings and cautions shown on the battery









TROUBLESHOOTING GUIDE - TEST WITHOUT TRAILER FIRST

No Trailer Connected

Condition	Display	Probable Cause	Probable Solution
Display does not light up when brake pedal or manual control is used	Blank 	No power to controller, no ground, reversed black and white wires, circuit breaker blown	Check and repair connections. Refer to the 'wiring' section
Display shows 'Not Connected'		Red wire connected to the wrong side of the stoplight switch or to wrong wire	Check and repair connections. Refer to the 'wiring' section
Display shows 'Low Volt' - can occur with the trailer connected		Tow vehicle's system voltage low	Check tow vehicle's battery and charging system
Display shows 'Short' when manual control is applied		Red wire connected to ground side of stoplight switch or is shorted to ground	Check brake controller wiring, may require change to switch setting. See 'manual control' section
Display shows 'Overload' when the brake pedal or manual override is used		Short in blue wire output circuit or trailer plug	Locate and correct short
Display shows nothing when battery power has been connected for a period of time and the engine is not being cranked	Blank 	Inadequate battery or ground wiring to brake controller	Check brake controller wiring

* This guide is for reference only. If problems persist, see a professional installer.

With Trailer Connected

Condition	Display	Probable Cause	Probable Solution
Display shows 'Not Connected' when power is applied to controller. No trailer brakes when brake pedal or manual control is used		No connection between brake controller and trailer brakes – blue wire circuit	Confirm connection to trailer connector Confirm connector terminal positions Check trailer
No trailer brakes, pedal or manual	Output power not flashing 	Mis-wired trailer connector	Confirm trailer connector terminal positions
No trailer brakes, pedal or manual		Short or overload in trailer brakes	Troubleshoot trailer brake circuit per brake manufacturer's instructions
Weak or no trailer brakes or trailer lights illuminate with brakes	Output power not flashing 	Mis-wired trailer	Check and correct trailer wiring
Trailer brakes on all the time		Mis-wired trailer connector	Check and correct connector wire positions
Display shows 'Error' after releasing brake		Internal error	Replace brake controller
No trailer brakes, pedal or manual		Loss of trailer connection, unplugged or bad wiring	Stop and check trailer connector

Learn more about trailer hitches on our website.