



# CURT™

The FIRST Name  
in Towing Products™

# TRIFLEX

## TRIFLEX BRAKE CONTROL INSTALLATION AND USER GUIDE

For use with 12 volt negative ground systems only  
For trailers with two to eight brakes

Read, follow and save this guide for future reference



***This package includes:***

- (1) Brake control module with quick plug
- (1) Mounting bracket
- (6) Mounting bracket screws
- (1) Quick reference card

**One or more of the following may be needed to complete installation:**

- Brake control connection harness, supplied with the tow vehicle (if equipped)
- CURT quick plug adapter harness - custom connector for specific vehicles.

See catalog for availability

- CURT part# 51515 / 51516 - male quick plug with pigtails
- CURT part# 51500 - brake control wiring kit

**Important Information**

Read and follow installation and setup instructions carefully. Failure to do so could result in damage to the brake control unit, no trailer brakes or poor brake performance. Disconnect the electrical plug between the trailer and tow vehicle before testing a breakaway switch.

Failure to disconnect may damage the brake control unit.

Avoid mounting the brake control module near a CB radio or other RF transmitter.

**WARNING:** The brake control unit must be mounted firmly in place.

Failure to do so could lead to improper operation and/or brake failure.

**WARNING:** The brake control unit's positive (with 30 amp circuit breaker) and ground wires must be connected directly to the tow vehicle's battery using 10 gauge minimum stranded wire. Connecting to existing wiring or an alternate ground may damage vehicle circuits, lead to failure of the brake control module, loss of trailer brakes or vehicle fire.

**NOTICE:** Removal of the factory supplied quick plug can void warranty.

## **Key Features**

- Digital display provides detailed brake force output and sensitivity position
- Provides automatic and manual trailer braking
- Switchable manual control output, 100% or limited to output setting
- Switchable manual control brake light activation or no brake light activation
- Compatible with electronic systems (anti-lock brakes and cruise control)
- Protected against reverse voltage, voltage spikes, shorts and overloads
- Power conservation mode after 30 min. of inactivity, wakes when brake pedal is pushed
- Display is capable of communicating operational errors
- Reduced output when sitting still (railroad crossing, stoplight, etc...)
- Automatically compensates for uphill and downhill road conditions
- Will work with most electrically activated hydraulic trailer brake systems
- Connects to vehicle with CURT 55515 quick plug, available separately (see CURT catalog for a list of application specific quick plug harnesses)

## Controls and Components

1. Digital display
2. Sensitivity adjustment
3. Output adjustment thumb wheel
4. Manual control lever
5. Quick plug connector
6. Switch for manual control max output, 100% or output setting
7. Switch for manual control stoplight activation
8. Mounting bracket

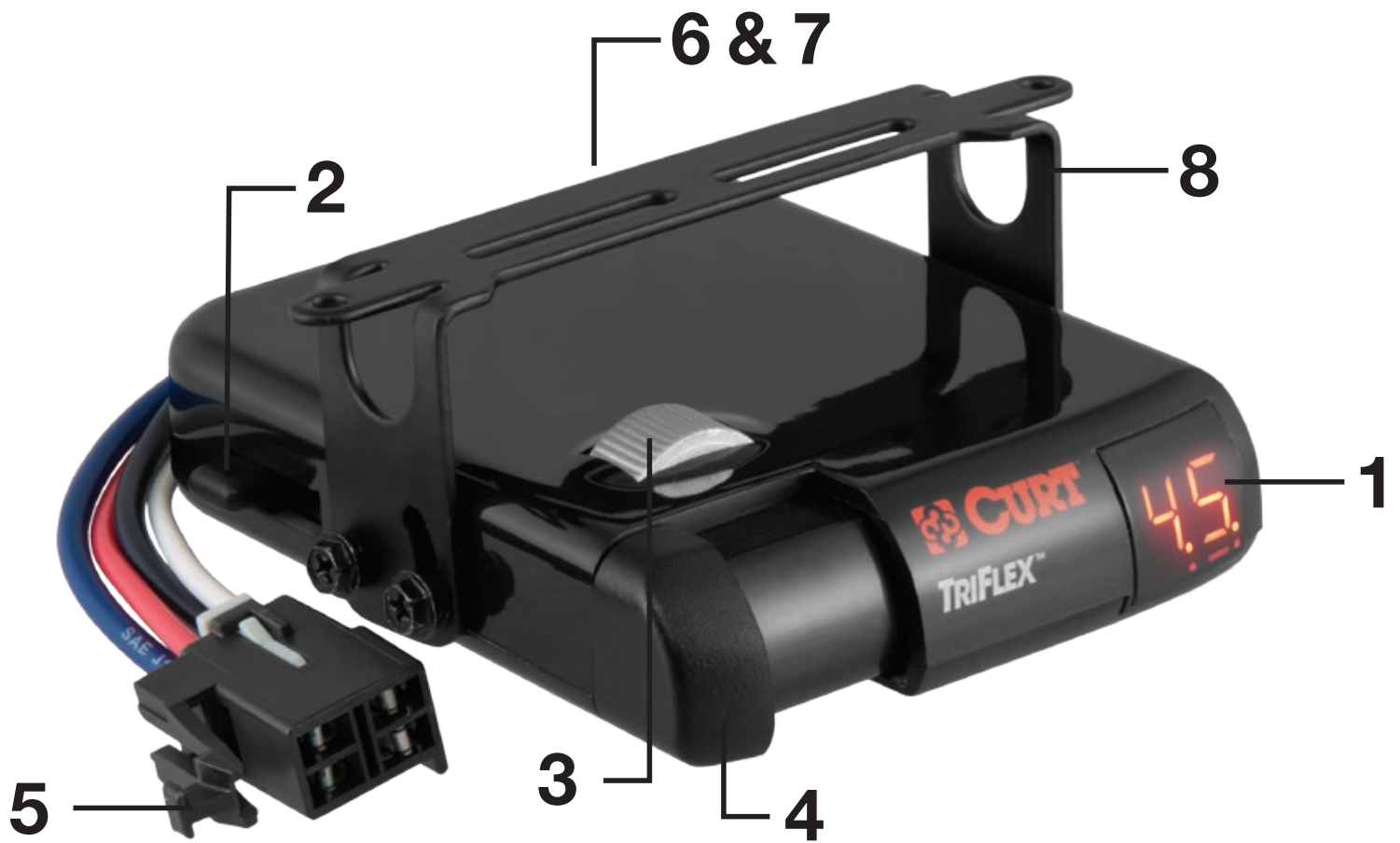

## **CONTROLS AND DISPLAY**

### **Output Control**

The output control thumbwheel establishes the maximum amount of power available to the trailer brakes when braking. The only exception would be when the manual control is setup for 100% braking, see 'Set Manual Control Output and Brake Light Switches'.

As the output control is rotated, a flashing display shows the setting. When turned to the right, more power will be available to the brakes; when turned to the left, less power will be available. Display flashes the setting for a few seconds after adjustment is complete. The output control would be adjusted during initial setup, when trailer load changes, when different trailers are used or when adjustment is needed for changing road or driving conditions.

The maximum output setting is shown on the display when a trailer is connected and the brake pedal is pressed or the manual control is actuated. If a trailer is not connected the output setting is flashed when the brake pedal is pressed or the manual control is actuated. The output setting is shown as **0.5** through **9.9**

### **Sensitivity Control**

The sensitivity control adjusts trailer brake aggressiveness. The trailer brakes become more aggressive as the switch is moved toward the driver. To view sensitivity setting on the display, move control slightly, the setting will flash.

Sensitivity adjustment has no effect on the manual control. The sensitivity control would be adjusted for individual driver preference, trailer load changes or

changing road conditions. The sensitivity control setting is shown as **L.1** through **L.9** with **L.1** being the least aggressive and **L.9** being the most aggressive.

The display flashes the setting for a few seconds after adjustment is complete.

## **Manual Control**

The manual control is located on the front of the brake control unit at the left side and only applies trailer brakes. Manual brake control activation is used during initial setup and in situations where a slow reduction in speed is desirable. As the manual control is pushed to the right, the brake control begins to apply the trailer brakes. The further to the right it is pushed the harder the brakes are applied.

















The manual control can be setup to either allow 100% of the unit's power to the trailer brakes or to limit power to the output control setting. This feature is setup at installation via a small switch at the rear of the unit. See 'Set Manual Control Output and Brake Light Switches'. The brake control unit is shipped from the factory with the switch in the 'limited to the output control' setting position.

The output will be shown on the display when the manual control is actuated. Brake light activation with the manual control is also an optional setting. Some tow vehicle's circuits do not allow power for brake lights from a second source.

In these applications, the brake light feature can be switched off using a second small switch at the rear of the unit. The brake light connection (red wire) is still required to activate the TriFlex brake control with the switch in either position. See 'Set Manual Control Output and Brake Light Switches'. The brake control unit is shipped from the factory with the switch in the 'activate brake light' position.

## Digital Display

The digital display shows the output setting when the control is activated. It is used to setup and monitor the brake control and can be used when trouble shooting.

 Blank display, does not illuminate when control is activated, check installation	 Flashing, trailer disconnected, off after 60 seconds
 Blank display, standby mode, illuminates when control is activated	 Recalibration needed, unplug and replug trailer connector
 Standby mode, no trailer connected	 Calibrating
 Standby mode, trailer connected	 Overloaded output circuit, trailer brake system fault
 Brakes activated	 Low voltage, tow vehicle system
 Flashing, output adjustment mode	 Accelerometer error, powers brakes using default values
 Flashing, sensitivity adjustment mode	 Stoplight wire (red) shorted to ground
 Trailer connected, checking calibration	 Battery power just connected or engine cranking

## INSTALLATION

### Set Manual Control Output and Brake Light Switches

There are two small switches located at the rear of the unit that can be accessed by removing the rectangular cover. Once accessed, the switch positions can be changed using a small pointed tool.

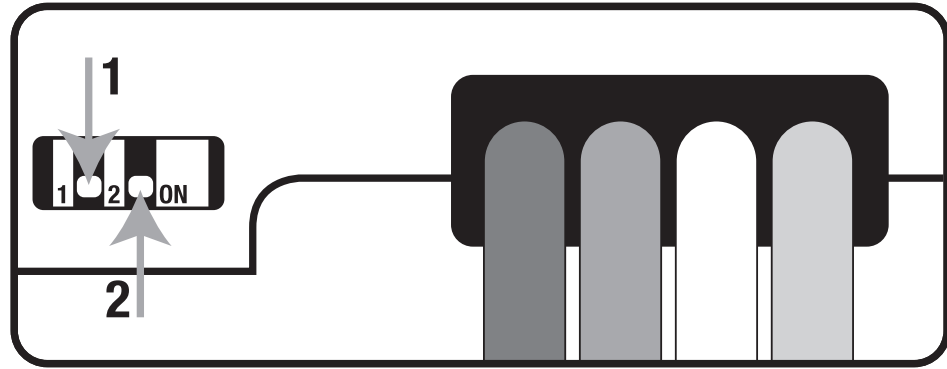

In the illustration above, the switch on the right (#2) controls the level of output available to the trailer brakes when using the manual control. The factory default setting is the 'ON' position with the switch down. This setting limits the manual control output to the level set using the output control thumb wheel. Moving this switch up to the 'OFF' position allows 100% of the output to the brakes when the manual control is actuated regardless of the output control setting.

In the illustration above, the switch on the left (#1) controls the unit's brake light activation feature. The factory default setting is the 'ON' position with the switch down. This setting activates the tow vehicle and trailer brake lights when the manual control is actuated. Moving the switch up to the 'OFF' position turns off the brake light activation feature and the brake lights are not activated when the manual control is actuated.



# Mounting

1. Determine a suitable mounting location.
  - A) The unit must be mounted securely to a solid surface
  - B) The unit must be easily reached by the driver
  - C) The area behind mounting location must be clear so no damage will be done when drilling

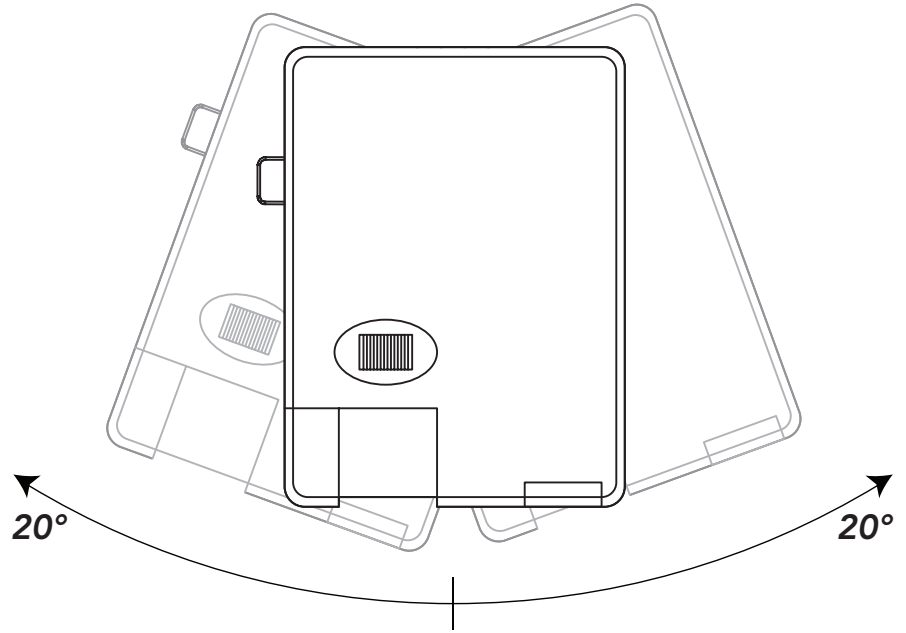
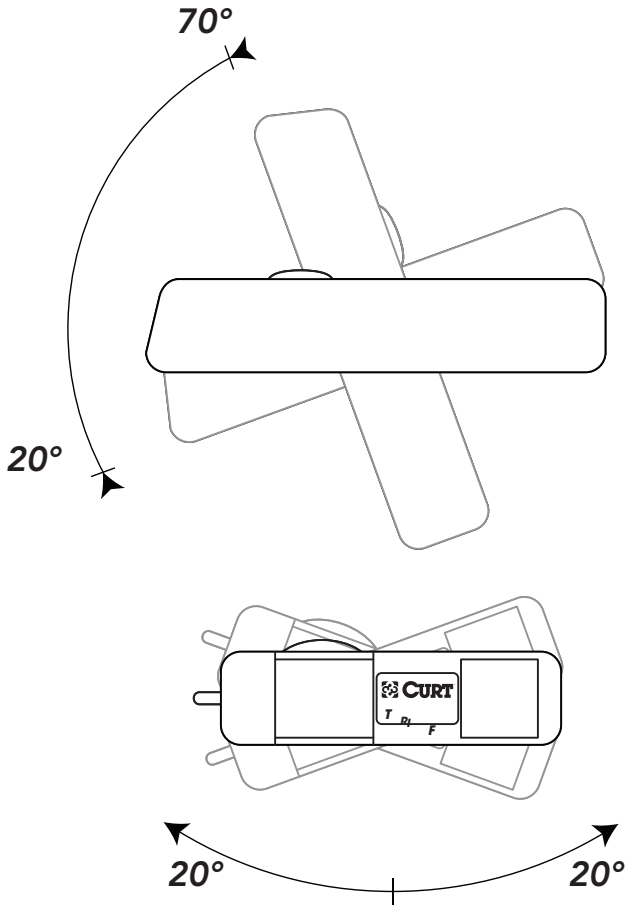

2. Hold the mounting bracket in the selected position and mark the hole locations through the bracket.
3. Using a 1/8" diameter bit, drill holes in the marked locations.
4. With a screwdriver or a 1/4" nut driver, secure the bracket in place using (2) self threading screws (provided). Do not over-tighten.
5. Mount the brake control unit in the bracket using (4) screws.

## **Wiring**

Disconnect the tow vehicle's negative battery terminal from its battery post before beginning the wiring process.

Most pick-ups and utility vehicles are equipped with a plug from the factory that allows quick brake control installation. Check the owner's manual for plug availability, location and installation.

If the mating plug supplied with the vehicle is no longer available, a CURT quick plug can be used. See the CURT catalog for application information.

For tow vehicles not equipped with a factory brake control plug, we suggest CURT brake control wiring kit, part# 51500.

Mount a 30 amp, auto reset, circuit breaker as close to the battery as possible.

**IMPORTANT:** When passing wire through sheet metal, always go through an existing grommet, add a grommet or use silicone sealer to protect the wire from sharp edges.

# WIRING DIAGRAM

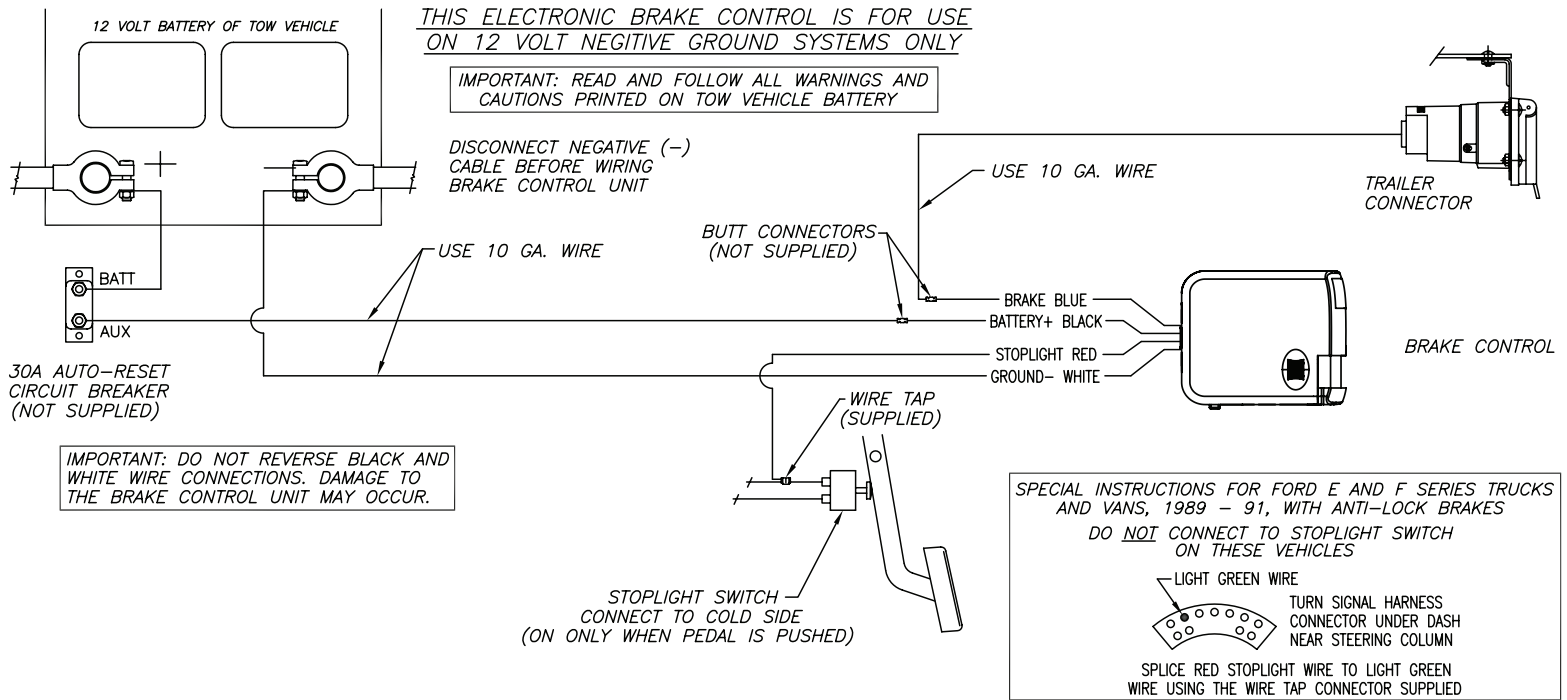

Feed two 10 gauge wires, one white and black, from the mounted brake control to the battery area. Using a ring terminal, connect the black wire to the 'AUX' side of the 30 amp circuit breaker. Leave the white wire to be connected later.

Using a 10/12 gauge butt connector, attach the black wire from the 'AUX' side of the 30 amp circuit breaker to the brake control's black wire. Again using a 10/12 gauge butt connector, attach the white wire from the battery area to the brake control's white wire. Run a 10 gauge blue wire from the tow vehicle's trailer plug "brake" terminal to the brake control. Using a 10/12 butt connector, connect this wire to the brake control's blue wire

**NOTE:** Stoplight switch connection on Ford vehicles including, Mercury Mountaineer. Do not connect to the red wire with a green stripe. Connect to the light green wire only.

For vehicles other than 1989-1991 Ford E and F Series trucks and vans with anti-lock brakes, use a test probe, determine which wire on the tow vehicle's stoplight switch is only "hot" when the pedal is pressed. Splice the brake control's red wire to this wire using a wire tap.

For 1989-1991 Ford E and F Series trucks and vans with anti-lock brakes:

Find the crescent shaped connector located on the steering column, the connector has two rows of wires. The wire needed is the light green wire, second from the end in the outside row of seven wires (see the box shown in wiring the diagram). Splice the brake control's red wire to light green wire using a wire tap.

Using 10 gauge stranded wire and ring terminals, connect the "BATT" side of the circuit breaker to the positive battery terminal.

Attach the white 10 gauge wire previously positioned near the battery to the negative battery terminal using a ring terminal. Reconnect the tow vehicle's negative battery terminal to its battery post. See vehicle's owner's manual for special battery re-connection instructions.

Test the installation without a trailer connected, by pushing the brake pedal. A single decimal point should light up on the display. If the decimal point does not light, or if **OL** , **RE** or **E.I** is shown refer to display messages. After testing secure all loose wires with cable ties so that they will not be damaged.

## SETUP

Once all electrical connections are complete and the single decimal point is seen, while parked on a level surface, plug the trailer's electrical connector into the tow vehicle's plug.

Making the trailer connection initiates the mounting position calibration mode.

**C.C.** may be seen on the display followed by either **...** or **r.C.** If **r.C.** appears, recalibration is needed. To recalibrate, unplug and replug the trailer's electrical connector. While calibrating, the display will show **C.L.** or may flash the Output setting. When **...** appears, the unit is calibrated and ready for setup.

Make the following preliminary adjustments with the trailer connected and engine running to ensure proper charge voltage. The vehicle must be in park or neutral with the parking brake applied, foot off the brake pedal, and no manual control actuation:

Adjust output to **20** by turning the output control wheel left or right as needed.

Adjust sensitivity to **L.I.** by moving the sensitivity control forward or back.

### Test Drive and Adjustment

Both output and sensitivity can be adjusted to achieve smooth firm stops.

Output and sensitivity adjustments should only be made while stopped, with the transmission in park or neutral, parking brake applied, foot off the brake pedal, and no manual control actuation. Output and sensitivity settings will flash while adjustments are made and for a few seconds after.

Start with the output adjustment. Drive forward on a paved or concrete surface that is dry and level. At approximately 25 mph, apply the tow vehicle brakes. If trailer braking is insufficient, adjust the output control to the right. If the trailer brakes lockup adjust the output control to the left. Repeat this step until stops are firm, just short of lockup.

Once the output is set, adjust sensitivity. Drive forward to approximately 25 mph and press the brake pedal. Tow vehicle and trailer should make smooth stops. If the stops seems slow and more aggressive braking is desired, move the sensitivity control toward the driver. If the stop seems too aggressive adjust the sensitivity control away from the driver.

Make several stops at various speeds and adjust sensitivity until stops are smooth and firm. Slight adjustment the output control may also be desirable.

**NOTE:** If any problems occur during setup, refer the trouble shooting section.

### **HELPFUL TIPS**

Light pressure on the manual control will activate the trailer's brakes with no effect on the vehicle's brakes. This is useful for gradual slowing on steep grades or before stops.

Periodic adjustment of the output and sensitivity controls may be necessary to correct for changing road conditions, trailer loading, brake wear or driver preference.

In some applications, when towing with hazard flashers on, the digital display will flash with the hazard flashers. If the brake control is set aggressively pulsing may be felt in the trailer brakes.

## **BENCH TEST INSTRUCTIONS**

### **Parts Needed:**

Standard 1156 automotive bulb in a socket, Charged 12V battery, Alligator clip test leads OR wire and wire nuts, 51515 / 51516 Quick plug with pigtails OR push pins

**NOTE:** If a quick plug pigtail is not available push pins can be used to make a direct connection to the female terminals of the TriFlex quick plug housing.

**CAUTION:** Ensure that the brake control wires, quick plug wires, push pins and test leads do not make contact with each other or any other metal surface – failure to do so may damage the brake controller.

### **Brake Controller Setup**

Connect the quick plug to the TriFlex to provide accessible wires for bench testing.

Connect the white ground wire of the TriFlex and the ground wire of the bulb to the negative terminal of the 12V battery.

Leave the red brake input wire and blue output wire unconnected.

Connect the black battery wire of the TriFlex to the positive terminal of the 12V battery. If the brake controller is wired properly and the TriFlex is operational the display will flash the current sensitivity level (ex. **1.9**) followed by a single decimal point **.** .

Ensure the TriFlex is level to the bench surface and connect the signal wire of the bulb to the blue brake output wire of the TriFlex.

The TriFlex will display that it's checking calibration **CL**, that it's calibrating **CL** or that it needs recalibration **r.CL**. If the **r.CL** indication appears, disconnect and reconnect the bulb from the blue wire to recalibrate. It will show **dL** when disconnected, **CL** and / or **CL** during calibration, followed by two decimal points **.00** when complete.

### **Manual Control Testing**

Rotate the output control thumb wheel right to its maximum setting **9.9** move the sensitivity adjustment toward the front of the unit to its most aggressive setting **1.9** and slowly activate the manual control up to its full output.

While actuating the manual control the brightness of the bulb will correspond with the output shown by the brake controller. Release the manual control to deactivate.

### **Accelerometer Testing**

While keeping the brake control level, connect the red brake input wire of the TriFlex to the positive terminal of the 12V battery. The brake control output will activate and the bulb may be dimly lit.

Slowly tilt the front of the TriFlex to about 45° and the brightness of the bulb will increase corresponding with the output shown by the brake controller. Slowly tilt the front of the TriFlex back to level and the brightness of the bulb will decrease corresponding with the output shown by the brake controller.

When finished testing disconnect the wiring from the positive terminal of the 12V battery ensuring the exposed contacts to not make contact. If the TriFlex does not function as described during the above test steps return the brake controller for service or replacement.







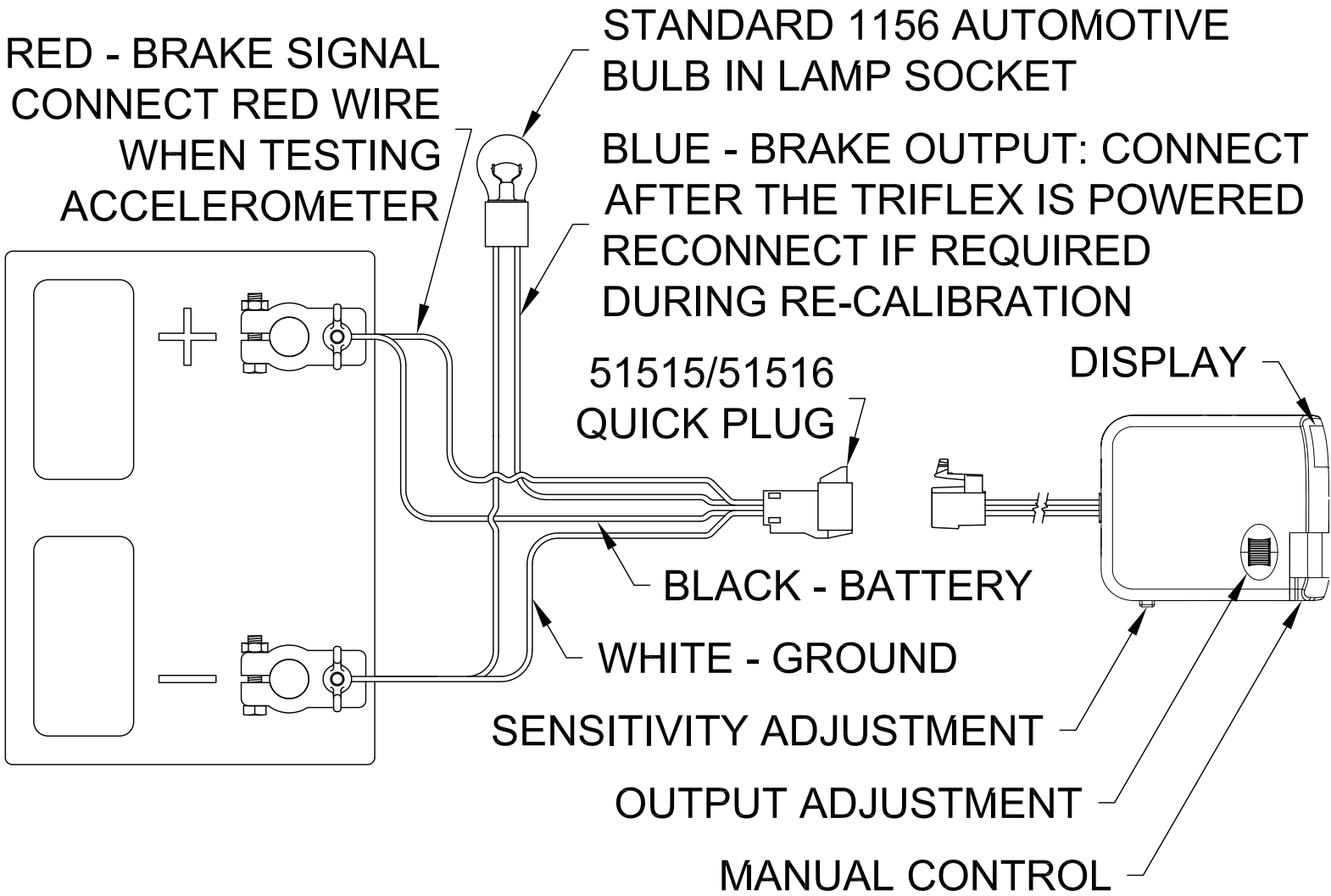

# BENCH TEST DIAGRAM

IMPORTANT: Read and follow all warnings and cautions shown on the battery







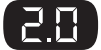

# TROUBLE SHOOTING GUIDE - TEST WITHOUT TRAILER FIRST

## No Trailer Connected

Condition	Display	Probable Cause	Probable Solution
Decimal point does not light when brake pedal or manual control is used	Blank 	No power to control, no ground, reversed black and white wires, circuit breaker blown	Check and repair connections. Refer to the 'wiring' section
Decimal point on after 30 min of inactivity	Decimal 	Red wire connected to the wrong side of the stoplight switch or to wrong wire	Check and repair connections. Refer to the 'wiring' section
Display shows L.b Can also happen with trailer connected	L.b. 	Tow vehicle's system voltage low	Check tow vehicle's battery and charging system
Display shows E.1. when manual control is applied	E.1 	Red wire connected to ground side of stoplight switch or is shorted to ground	Check brake control wiring, may require change to switch setting. See "manual control" section
Display shows OL when brake pedal or manual override is used	Flashing OL. 	Short in blue wire output circuit or trailer plug	Locate and correct short
Display shows -- when battery power has not just been connected and the engine is not being cranked	Double dash 	Inadequate battery or ground wiring to brake controller	Check brake control wiring

## With Trailer Connected

Condition	Display	Probable Cause	Probable Solution
Display shows only one decimal point when power is applied to control. No trailer brakes when brake pedal or manual control is used	Decimal 	No connection between brake control and trailer brakes – blue wire circuit	Confirm connection to trailer connector Confirm connector terminal positions Check trailer
No trailer brakes, pedal or manual	Output power not blinking 	Mis-wired trailer connector	Confirm trailer connector terminal positions
No trailer brakes, pedal or manual	Flashing 	Short or overload in trailer brakes	Troubleshoot trailer brake circuit per brake manufacturer's instructions
Weak or no trailer brakes or trailer lights illuminate with brakes	Output power not blinking 	Mis-wired trailer	Check and correct trailer wiring
Trailer brakes on all the time	Standby mode  Sleep mode 	Mis-wired trailer connector	Check and correct connector wire positions
Display shows A.E. after releasing brake		Internal error	Replace brake control unit
No trailer brakes, pedal or manual	Flashing 	Loss of trailer connection, unplugged or bad wiring	Stop and check trailer connector

\* This guide is for reference only. If problems persist, see a professional installer.