



31088 INSTALLATION INSTRUCTIONS



Safety glasses should be worn at all times while installing this product.

YEARS: 2019-CURRENT

MAKE: CHEVROLET/GMC

MODEL: SILVERADO/SIERRA 1500

STYLE: TRUCK

WARNING: NEVER EXCEED YOUR VEHICLE MANUFACTURER'S RECOMMENDED TOWING CAPACITY.

WEIGHT CARRYING:
TRAILER WEIGHT: 5000 LBS.
TONGUE WEIGHT: 500 LBS.

**GROSS LOAD CAPACITY WHEN USED AS A STRAIGHT LINE PULL:
9,000 LBS MAX.**

PRO INSTALL TIME: 30 MIN.
NOVICE INSTALL TIME: 60 MIN.
IF YOU ARE HESITANT TO UNDERTAKE THIS TASK ON YOUR OWN, CONTACT AN AUTHORIZED CURT INSTALLER FOR ADDITIONAL ASSISTANCE.



INSTALLATION TIPS:
1. BEFORE YOU BEGIN INSTALLATION, READ ALL INSTRUCTIONS THOROUGHLY.
2. TO EASE INSTALLATION, 2 PEOPLE MAY BE REQUIRED.
3. USING PROPER TOOLS WILL GREATLY IMPROVE THE QUALITY OF THE INSTALL AND REDUCE THE TIME REQUIRED



INSTALLATION REQUIRES:

 13mm 18mm 11/16" SOCKET	 RATCHET	 AVIATION SHEARS
 SCREW DRIVER	 MASKING TAPE	 TAPE MEASURE
 SAFETY GLASSES		

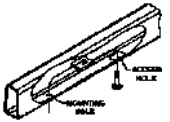
LEVEL OF DIFFICULTY: EASY

<i>EASY</i>	<i>MODERATE</i>	<i>CHALLENGING</i>
 TRIM	TRIMMING REQUIRED	
 FISHWIRE	FISHWIRE REQUIRED	
	NO DRILLING	

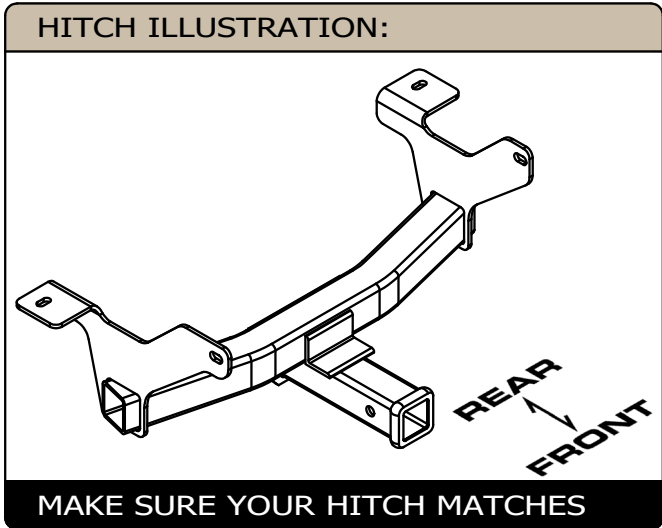

PERIODICALLY CHECK THIS RECEIVER HITCH TO ENSURE ALL FASTENERS ARE TIGHT AND ALL STRUCTURAL COMPONENTS ARE SOUND
CURT Manufacturing LLC. warrants this product to be free of defects in material and/or workmanship at the time of retail purchase by the original purchaser. If the product is found to be defective, CURT Manufacturing LLC. may repair or replace the product at their option, when the product is returned, prepaid, with proof of purchase. Alteration to, misuse of, or improper installation of this product voids the warranty. CURT Manufacturing LLC.'s liability is limited to repair or replacement of products found to be defective, and specifically excludes liability for incidental or consequential loss or damage.

INSTALLATION WALKTHROUGH:

Parts List			
ITEM	QTY	PART NUMBER	DESCRIPTION
1	1	M12-1.75 x 45mm	HEX BOLT
2	1	1/2"	CONICAL TOOTHED WASHER
3	2	7/16 - 14 x 1 3/4	CARRIAGE BOLT
4	2	CM-SP2	.250 x .88 x 2.25" SQUARE HOLE SPACER
5	2	7/16-14	HEX FLANGE NUT
6	2	7/16-14	HEX NUT
7	2	7_16 FISHWIRE	7/16" FISHWIRE

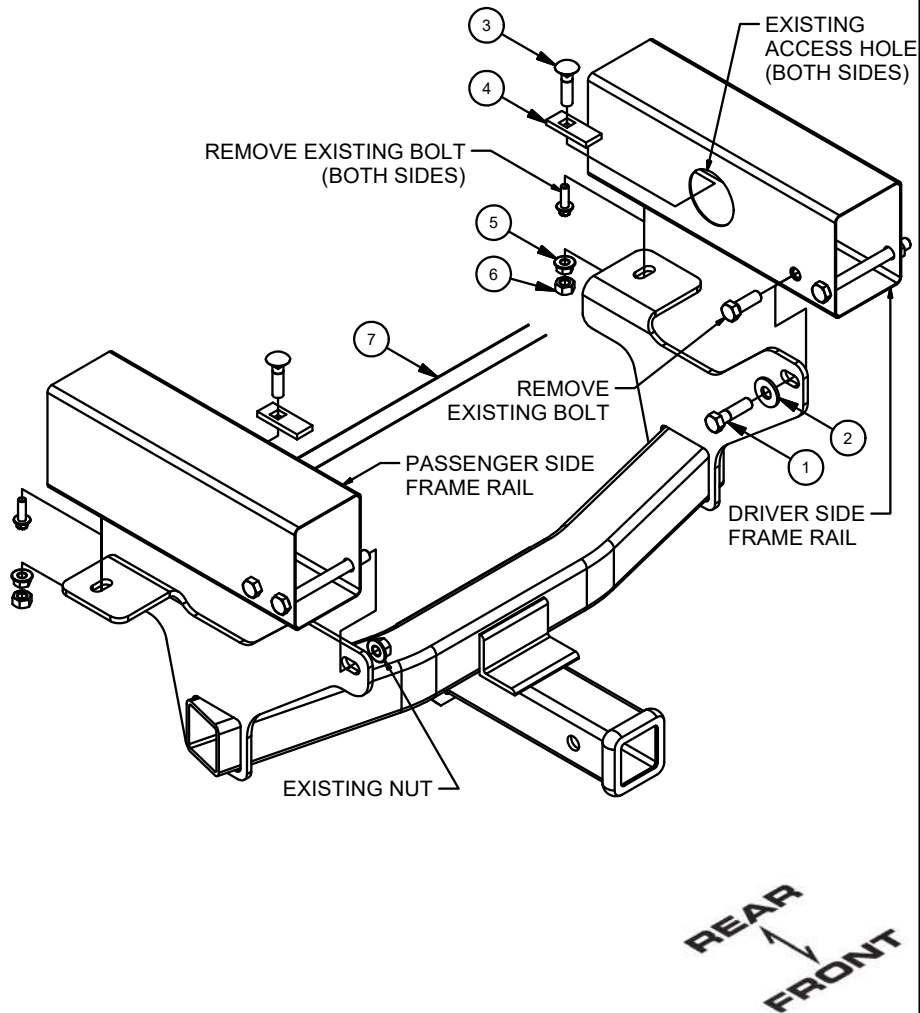

1. Remove underbody panel by removing (4) bolts with a 13mm socket. Remove (1) clip nut from each frame rail.



2. Remove rear tow hook bolt from the driver side frame rail and nut from the bolt in the passenger side frame rail.



INSTALLATION WALKTHROUGH:

3. Fishwire 7/16" carriage bolt and CM-SP2 spacer into the bottom hole of each frame rail through the access hole.



4. Trim lower air dam using the Trim Diagram below for reference.

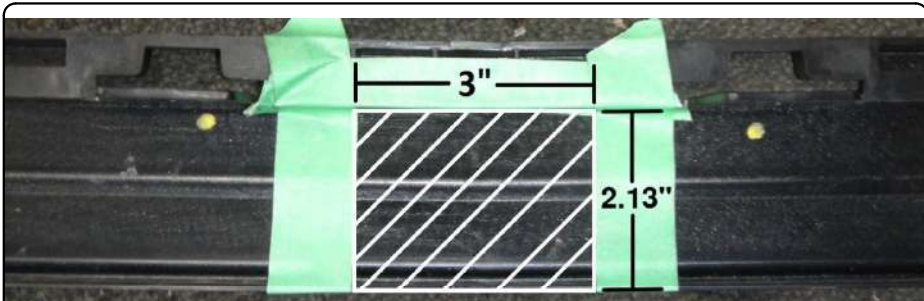

TRIM DIAGRAM

5. Raise hitch into position. Secure with supplied M12 bolt and conical washer to inside driver frame, inside passenger side frame with the removed M12 flange nut, and bottom of both frames with the included 7/16" hex flange nuts.



6. Torque 7/16" hardware to 59 ft-lbs and M12 hardware to 78.9 ft-lbs. Reinstall underbody panel using supplied 7/16" nuts.



CHEVROLET SILVERADO 1500 / GMC SIERRA 1500

***DO NOT EXCEED VEHICLE MANUFACTURER'S RECOMMENDED TOWING CAPACITY ***.

FRONT MOUNTED ACCESSORIES

1) Do not exceed front axle Gross Weight Rating (GAWR). Consult owners manual or specification plate located on driver's door frame. Measure gross front axle weight by placing front wheels of loaded vehicle on a scale.

WARNING: Exceeding GAWR may overload the front axle and/or suspension. This could result in **accident, property damage and personal injury.**

2) Reposition front mounted license plate if obstructed.

3) Do not obstruct vehicle lights.

4) Allow free air flow into grille opening.

5) Rear wheel traction may be reduced. This could effect handling. Reduce speed and drive with caution.

6) Accessories extend front of vehicle. This may reduce approach angle. Use caution when parking and maneuvering.

7) Do not obstruct driver view.

VEHICLE RECOVERY AND WINCHING TIPS

1) Use OEM tow hooks, recovery eyes or a clevis mount for attachment of a tow strap or winch cable.

WARNING: NEVER use a ball and/or ball mount as an anchor point for tow strap or winch cable. Severe personal injury or death could result.

2) Observe winch manufacturer's recommendations, cautions and warnings.

3) Attach return cable to tow hook or recovery eye when using a snatch block (See figure 1).

CAUTION: Do not attach return cable to winch mount. This may overload winch mount and/or front mounted receiver.

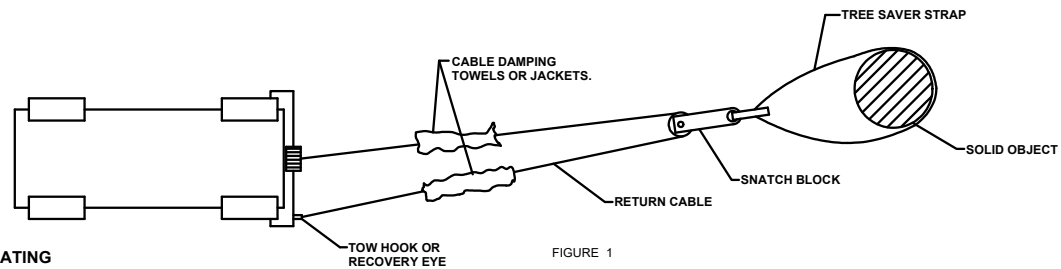

RATING

For **Maximum** line pull rating, winch cable must not exceed:

- 15 degree angle up or down from horizontal (See Figure 2).
- 45 degree angle left or right from straight ahead (See Figure 3).

CAUTION: Exceeding the maximum line pull rating may over load winch, winch mount, and/or front mounted receiver.

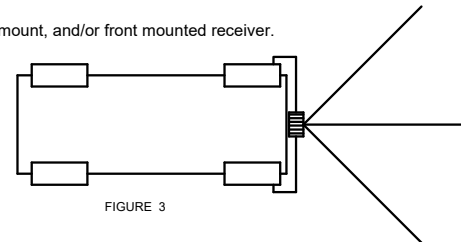
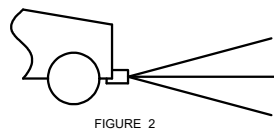

31088

CHEVROLET SILVERADO / GMC SIERRA 1500

GROSS LOAD CAPACITY WHEN USED AS A WEIGHT CARRYING HITCH: 5000 LBS. TRAILER WEIGHT & 500 LBS. TONGUE WEIGHT.
 GROSS LOAD CAPACITY WHEN USED AS A STRAIGHT LINE PULL: 9,000 LBS. MAX. LINE PULL.



WARNING: * DO NOT EXCEED VEHICLE MANUFACTURER'S RECOMMENDED TOWING CAPACITY. *****



Parts List			
ITEM	QTY	PART NUMBER	DESCRIPTION
1	1	M12-1.75 x 45mm	HEX BOLT
2	1	1/2"	CONICAL TOOTHED WASHER
3	2	7/16 - 14 x 1 3/4	CARRIAGE BOLT
4	2	CM-SP2	.250 x .88 x 2.25" SQUARE HOLE SPACER
5	2	7/16-14	HEX FLANGE NUT
6	2	7/16-14	HEX NUT
7	2	7_16 FISHWIRE	7/16" FISHWIRE

TOOLS REQUIRED
13mm & 18mm SOCKETS
11/16" SOCKET
RATCHET
18mm WRENCH
SCREWDRIVER
AVIATION SHEARS
TAPE MEASURE
TAPE
SAFETY GLASSES

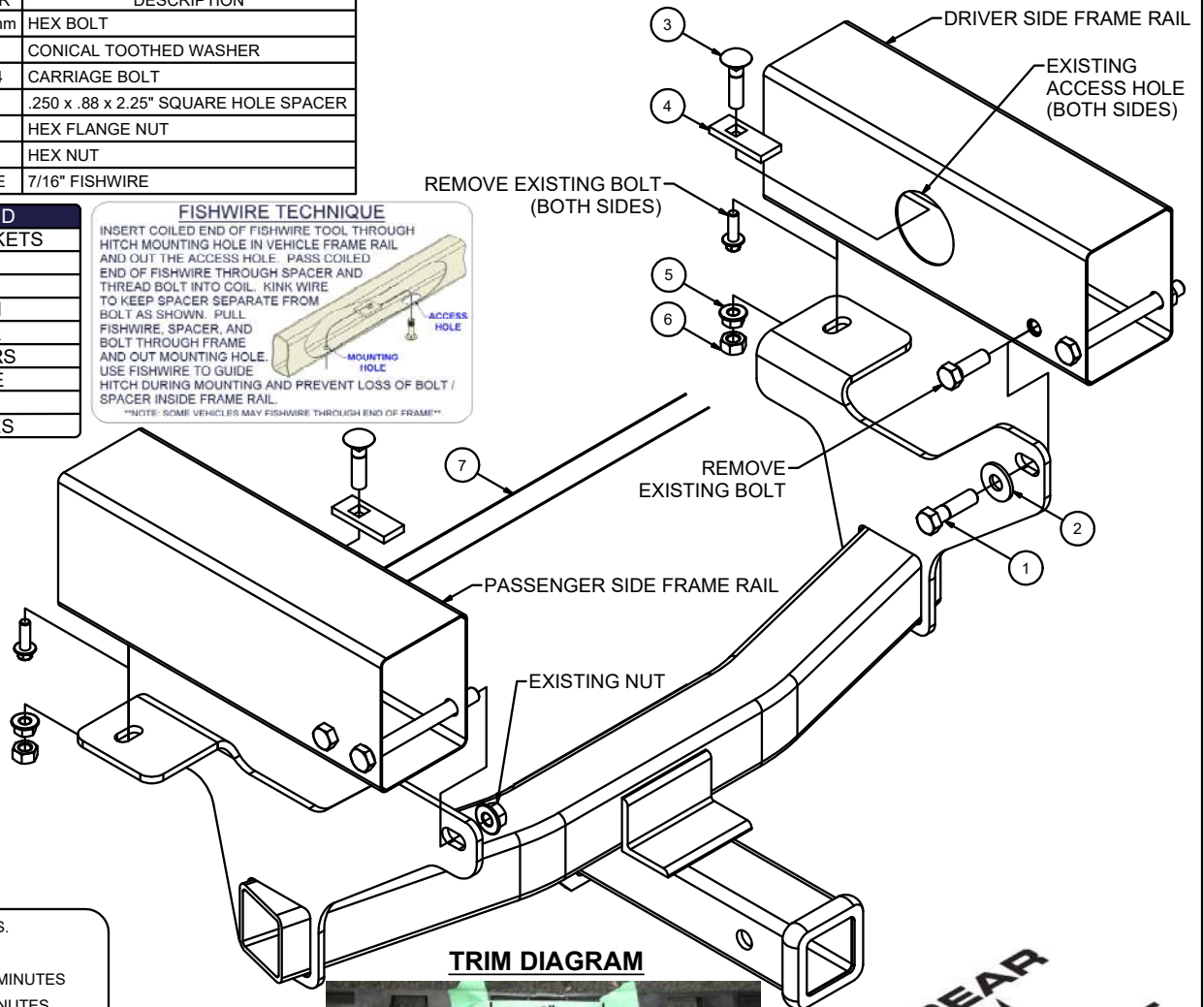
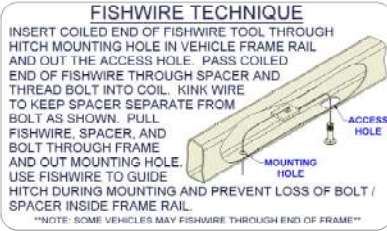

HITCH WEIGHT: 30 LBS.

INSTALL TIME

PROFESSIONAL: 30 MINUTES

NOVICE (DIY): 60 MINUTES

INSTALL NOTES:

- NO DRILL
- TRIMMING REQUIRED
- FISHWIRE REQUIRED

INSTALLATION STEPS

1. Remove underbody panel by removing (4) bolts with a 13mm socket. Remove (1) clip nut from each frame rail.
2. Remove rear tow hook bolt from the driver side frame rail and nut from the bolt in the passenger side frame rail.
3. Fishwire 7/16" carriage bolt and CM-SP2 spacer into the bottom hole of each frame rail through the access hole.
4. Trim lower air dam using the Trim Diagram above for reference.
5. Raise hitch into position. Secure with supplied M12 bolt and conical washer to inside driver frame, inside passenger side frame with the removed M12 flange nut, and bottom of both frames with the included 7/16" hex flange nuts.
6. Torque 7/16" hardware to 59 ft-lbs and M12 hardware to 79 ft-lbs. Reinstall underbody panel with supplied 7/16" nuts.

PERIODICALLY CHECK THIS RECEIVER HITCH TO ENSURE THAT ALL FASTENERS ARE TIGHT AND THAT ALL STRUCTURAL COMPONENTS ARE SOUND.

CURT Manufacturing LLC., warrants this product to be free of defects in material and/or workmanship at the time of retail purchase by the original purchaser. If the product is found to be defective, CURT Manufacturing LLC., may repair or replace the product, at their option, when the product is returned, prepaid, with proof of purchase. Alteration to, misuse of, or improper installation of this product voids the warranty. CURT Manufacturing LLC.'s liability is limited to repair or replacement of products found to be defective, and specifically excludes liability for incidental or consequential loss or damage.

CHEVROLET SILVERADO / GMC SIERRA 1500

*****DO NOT EXCEED VEHICLE MANUFACTURER'S RECOMMENDED TOWING CAPACITY***.**

FRONT MOUNTED ACCESSORIES

1) Do not exceed front axle Gross Weight Rating (GAWR). Consult owners manual or specification plate located on driver's door frame. Measure gross front axle weight by placing front wheels of loaded vehicle on a scale.

WARNING: Exceeding GAWR may overload the front axle and/or suspension. This could result in **accident, property damage and personal injury.**

- 2) Reposition front mounted license plate if obstructed.
- 3) Do not obstruct vehicle lights.
- 4) Allow free air flow into grille opening.
- 5) Rear wheel traction may be reduced. This could effect handling. Reduce speed and drive with caution.
- 6) Accessories extend front of vehicle. This may reduce approach angle. Use caution when parking and maneuvering.
- 7) Do not obstruct driver view.

VEHICLE RECOVERY AND WINCHING TIPS

1) Use OEM tow hooks, recovery eyes or a clevis mount for attachment of a tow strap or winch cable.

WARNING: NEVER use a ball and/or ball mount as an anchor point for tow strap or winch cable. Severe personal injury or death could result.

- 2) Observe winch manufacturer's recommendations, cautions and warnings.
- 3) Attach return cable to tow hook or recovery eye when using a snatch block (See figure 1).

CAUTION: Do not attach return cable to winch mount. This may overload winch mount and/or front mounted receiver.

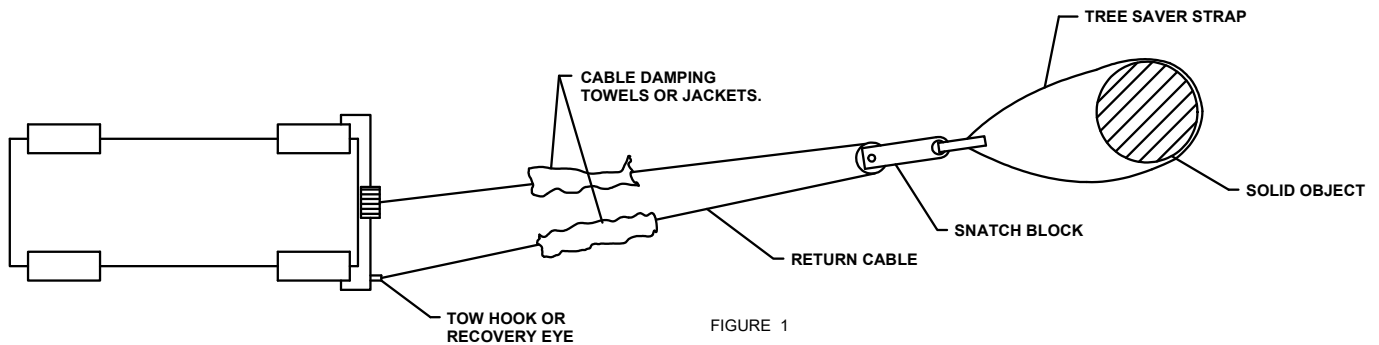

RATING

- For **Maximum** line pull rating, winch cable must not exceed:
- 15 degree angle up or down from horizontal (See Figure 2).
 - 45 degree angle left or right from straight ahead (See Figure 3).

CAUTION: Exceeding the maximum line pull rating may over load winch, winch mount, and/or front mounted receiver.

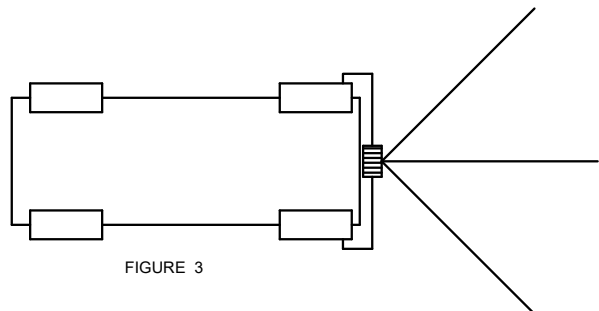
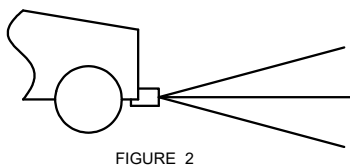

CURT Manufacturing LLC., warrants this product to be free of defects in material and/or workmanship at the time of retail purchase by the original purchaser. If the product is found to be defective, CURT Manufacturing LLC., may repair or replace the product, at their option, when the product is returned, prepaid, with proof of purchase. Alteration to, misuse of, or improper installation of this product voids the warranty. CURT Manufacturing LLC.'s liability is limited to repair or replacement of products found to be defective, and specifically excludes liability for incidental or consequential loss or damage.